

THE EXCAVATIONS AT TELL AL RIMAH

THE POTTERY

Carolyn Postgate, David Oates, Joan Oates



Iraq Archaeological Reports 4.

Carolyn Postgate, David Oates & Joan Oates

THE EXCAVATIONS AT TELL AL RIMAH: THE POTTERY

The site of Tell al Rimah lies at the northern edge of the Iraqi Jazirah. It is noted in particular for its elaborately ornamented Old Babylonian temple and its unique evidence for third millennium BC vaulting techniques. The site was occupied throughout the second and third millennia BC and, briefly, during Late Assyrian times. This volume presents the complete repertoire of second and first millennium pottery, together with a summary of the history and stratigraphy of the site. This material, which is both extensive and unusually well dated owing to its association with cuneiform evidence, constitutes by far the largest publication of Middle and Late Bronze Age (Old Babylonian, Mitanni and Middle Assyrian) pottery from Northern Mesopotamia. The book is a valuable resource of information for sites throughout the region.

**LIBRARY
THE
UNIVERSITY MUSEUM**



**UNIVERSITY
OF
PENNSYLVANIA**

**THE EXCAVATIONS AT TELL AL RIMAH:
THE POTTERY**

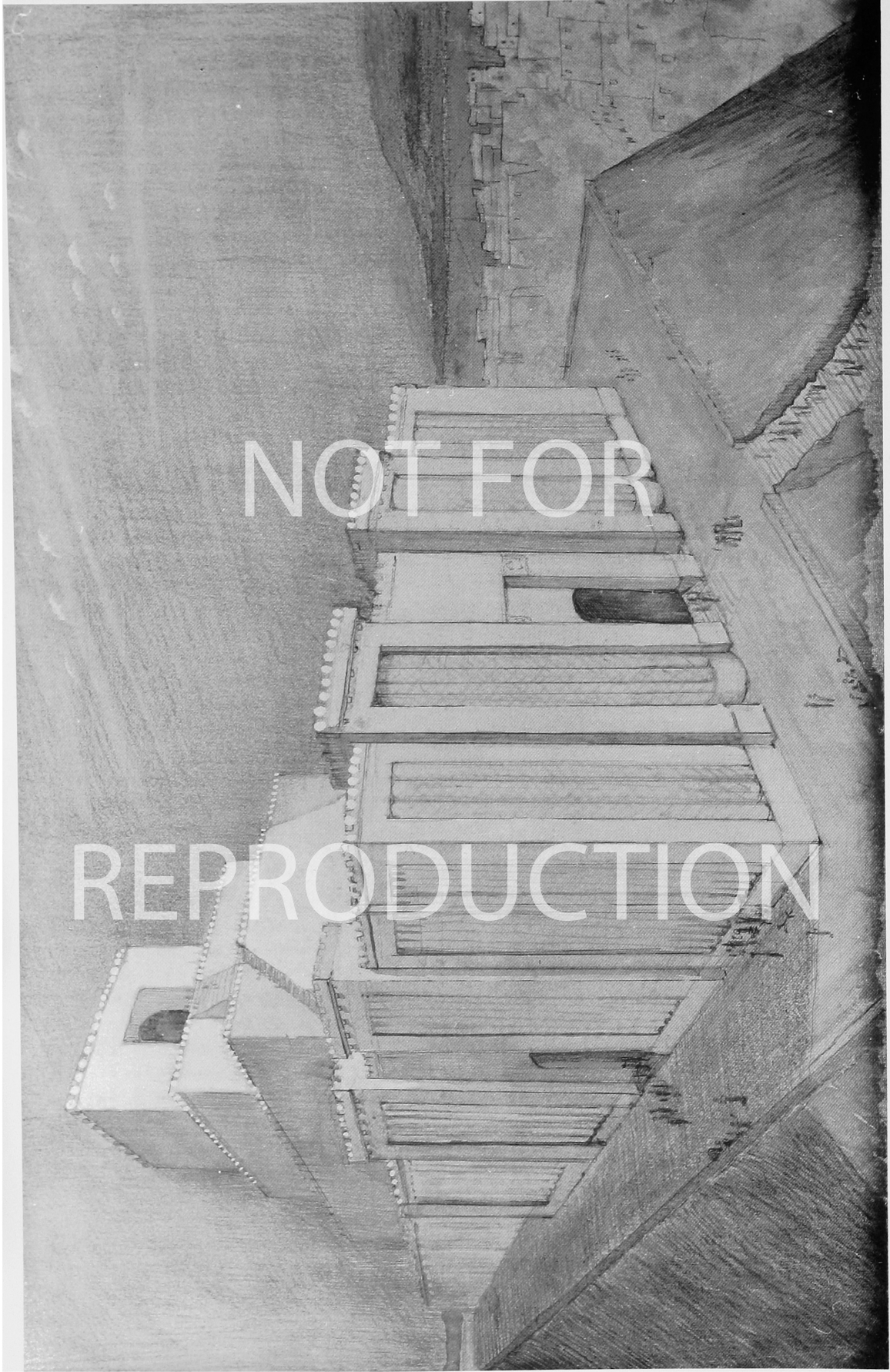

Artist's impression of the Great Temple at Tell al Rimah in the Old Babylonian period. Pastel drawing by Ulrica Lloyd.

IRAQ ARCHAEOLOGICAL REPORTS – 4

**THE EXCAVATIONS AT TELL AL RIMAH:
THE POTTERY**

Carolyn Postgate, David Oates, Joan Oates

class sep

BRITISH SCHOOL OF ARCHAEOLOGY IN IRAQ

MUSEUM / DS / 70.5 / R573 / P778 / 1997

© C. Postgate, D. Oates, J. Oates 1997

All rights reserved. No part of this publication may be reproduced or stored in a retrieval system or transmitted in any manner or by any means without the prior permission of the publishers in writing.

ISBN 0-85668-700-6

Printed and published in England for the
British School of Archaeology in Iraq by
Aris and Phillips Ltd.
Teddington House, Warminster
Wiltshire, England

UNIVERSITY
OF
PENNSYLVANIA
LIBRARIES

Table of Contents

Text figures	7
Plates	9
Acknowledgements	13
Introduction	15
The site	18
The ancient name of Tell al Rimah	18
Chapter 1: The Excavations	21
Site A	21
a) The Great Temple	
b) Area AS – the sounding on the south side of the central mound	
Site C	30
a) The Palace	
b) The Late Old Babylonian “kitchen”	
c) Rimah under Mitanni suzerainty	
d) Middle and Late Assyrian levels	
Site A: The Late Assyrian Temple	41
Site D	43
Stratigraphic Summary	44
The Graves.....	45
Chapter 2: The Pottery	51
a) Khabur ware	
b) Nuzi ware	
c) Old Babylonian pottery	
d) Mitanni pottery	
e) Middle and Late Assyrian pottery	
f) Post-Assyrian Pottery	
Abbreviations and Bibliography	58
Chapter 3: Notes to the Plates	61
The Plates	77
Index of Pottery Batches	255
Index of Catalogued Pottery	269

Text figures

1.	Map of Northern Iraq.....	16
2.	Plan of Tell al Rimah.....	17
3.	Site A Axonometric reconstruction of Great Temple.....	22
4.	Site A Plan of Great Temple.....	24
5.	Site A Level 2 plan above north temple façade.....	25
6.	Plan of Area AS.....	28
7.	Area AS section.....	29
8.	Site C Palace with earlier Shamshi-Adad Palace.....	31
9.	Site C Palace.....	32
10.	Site C Axonometric reconstruction of the Palace.....	33
11.	Site C “kitchen”.....	35
12.	Site C level 5 Mitanni.....	38
13.	Site C level 4 Middle Assyrian.....	39
14.	Site C section, squares Cn I/II west face.....	40
15.	Late Assyrian temple.....	42
16.	Column graph: carinated bowls (Plate 28).....	61
17.	Column graph: carinated bowls (Plates 29-30).....	62
18.	Column graph: carinated bowls (Plate 31).....	62
19.	Column graph: red-rimmed shallow bowls (Plate 34, pots 105-108).....	62
20.	Column graph: shallow bowls (Plates 35-37).....	63
21.	Column graph: bowls (Plate 38, pots 176-182).....	63
22.	Column graph: bowls (Plate 38, pots 183-189).....	63
23.	Column graph: burnished bowls (Plate 40, pots 201-206).....	64
24.	Column graph: burnished bowls (Plates 44-45).....	65
25.	Column graph: rough-based shallow bowls (Plates 47-50).....	65
26.	Column graph: bowls (Plate 51).....	66
27.	Column graph: small bowls, lids and lamps (Plates 52-54).....	66
28.	Column graph: fine bowls (Plate 59, pots 527-530).....	67
29.	Column graph: painted jar sherds (Plate 60, pot 558).....	67
30.	Column graph: hole-mouth bowls (Plates 61-62).....	67
31.	Column graph: cooking pots (Plate 63, pots 589-596).....	68
32.	Column graph: deep bowls (Plate 64, pots 604-608).....	69
33.	Column graph: nipple-based beakers (Plate 67, pots 648-654).....	69
34.	Column graph: bases from Site C (Plate 67, pots 662 and 666).....	70
35.	Column graph: Nuzi ware (Plates 68-71).....	70
36.	Column graph: painted shouldered beakers (Plate 76).....	71
37.	Column graph: “grain measures” (Plate 77, pots 852-862).....	71
38.	Column graph: painted “grain measures” (Plate 78).....	71
39.	Column graph: small shouldered beakers (Plate 79, pots 879-881).....	72
40.	Column graph: painted fine ware beakers (Plate 79, pots 890-898).....	72
41.	Column graph: Khabur ware jars (Plate 90).....	73
42.	Column graph: strainers (Plate 92).....	73
43.	Column graph: “pie-crust” potstands (Plates 93-94).....	74
44.	Column graph: fenestrated stands (Plate 96).....	74
45.	Column graph: distribution of black and grey wares.....	74
46.	Column graph: fine ware high ring bases (Plate 100, pot 1218).....	75
47.	Column graph: glazed sherds.....	75
48.	Column graph: strap handles.....	75

Plates

1. a) Tell al Rimah from the south.
b) Central tell: Site A and Area AS (1968).
2. a) Site A Temple: Level 2 Room 5.
b) Site A Entrance to the Temple antechamber.
c) Site A Temple Room 47: storage magazine.
3. a) Site A Temple: Room II showing destruction level pottery (A565).
b) Site A Temple: succession of Level 3 pavements.
4. a) Site A Temple: Room III from the southwest.
b) Area AS showing third millennium graves (AG 2-68 and AG 3-68).
5. a) Site A Temple: view from the east through the antecella and cella doorways.
b) Site A Temple: Detail of antecella doorway with the second Level 3 courtyard pavement.
6. a) Site A The east façade of the Temple courtyard, showing Level 3 spiral columns.
b) Site A Impost block to the left of the entrance to the Temple antechamber.
7. a) The Humbaba impost block on the right of the entrance to the Temple antechamber.
b) The second Humbaba impost block, possibly of Mitanni date (Mosul Museum).
8. a) Bull-man impost block (Mosul Museum).
b) Scorpion-man orthostat from the Temple, Mosul marble.
9. a) Side view of Humbaba 2 impost block (Plate 7b).
b) Area AS, detail of third millennium BC domical vault.
10. a) View of Site B with Site C in the background, 1964.
b) The Rimah wadi in spate, outside the northeast town wall, April 1971.
11. a) Site C Late Assyrian houses 1968.
b) Site C Small Middle Assyrian shrine 1968.
12. a) Site C Mitanni Rooms 55-59 from the southeast 1967.
b) Site C Level 6 Palace antechamber (Room XIV) from the west.
13. Site C West section 1971.
14. a) Site C West end of Palace Room II.
b) View of the Late Assyrian shrine.
15. Stele dedicated to Adad-Nerari III by Nergal-Eresh, found in the cella of the Late Assyrian shrine.
16. Site D Mitanni burial vault (DG 22-66).
17. Site D Late Assyrian graves:
 - a) graves DG 8a,b,c-66.
 - b) grave DG 8a-66, jar 979.
 - c) grave DG 8b-66, jar 977.
 - d) grave DG 13-66, bowl 598.
 - e) grave DG 7-66, jar 945.
 - f) grave DG 3-66, jar 949.

18. Site C Late Assyrian grave CG 5-68, deep bowls 601-603.
19. Khabur ware sherds, largely Site A Levels 3 and 4, Nuzi ware and Late Assyrian sherds.
20.
 - a) Mitanni nipple-based beaker 729.
 - b) Late Old Babylonian beaker 824.
 - c) Middle Assyrian elongated beaker 781.
 - d) Mitanni pig pot 1186.
 - e) Late Old Babylonian beaker 804.
 - f) Mitanni spouted bowl 612.
- 21, 22. Nuzi ware from Site C, courtesy of University Museum, Philadelphia.
23.
 - a) Early Mitanni sherd with bird ornament 1056.
 - b) Nuzi ware, horned animal (C5b).
 - c) Nuzi ware beaker base 724.
 - d) Mitanni grey ware, impressed ornament with white inlay (sherds 1205, 1209, 1202).
 - e) Fragment of Mitanni straight-sided burnished dark grey-brown vessel, inlaid on top and sides (TR 3325).
 - f) Grey Mitanni vessel with white inlay; shape similar to (e).
24.
 - a) Tall stand 1180, from Room V in the Great Temple.
 - b) Inscription on storage jar 1036.
 - c) Fragment of Old Babylonian bread mould 1194.
 - d) Old Babylonian lid 429.
 - e) Mitanni architectural model 1192.
25. Glazed pottery and wall cones:
 - a) Middle Assyrian pale green glazed spouted bowl, Site A Room 15 (TR 2608).
 - b,c) Mitanni green-glazed wall cone, from outside the east gate of the Great Temple (TR 2602).
 - d) Wall cone, Site C Level 4 (TR 5112).
 - e) Wall cones from the Site C Palace (TR 5126, TR 5130, TR 5135).
 - f) Pale green glazed compartmented dish (TR 4313), from the Late Assyrian shrine.
26. Late Assyrian pottery:
 - a,b) Jar 948 on potstand 1137 and *in situ* in shrine.
 - c) Bottle 928.
 - d) Tall stand 1175, Late Assyrian shrine.
27. Area AS, late third millennium BC sherds:
 - a,b) Post-Akkadian sherds (cf *Iraq* 32, 25 ff.)
 - c) Akkadian sherds.
28. Carinated bowls – Middle Assyrian (1-21)
29. Carinated bowls – Middle Assyrian (22-29)
30. Carinated bowls – Middle Assyrian (30-48)
31. Carinated bowls – Middle Assyrian and Mitanni (49-73)
32. Carinated bowls – Mitanni (74-91)
33. Carinated bowls – Mitanni (92-104)
34. Red-rimmed bowls – Middle Assyrian and Mitanni (105-121)
35. Shallow bowls – Middle Assyrian and Mitanni (122-137)
36. Shallow bowls – Middle Assyrian and Mitanni (138-152)
37. Shallow bowls – Middle Assyrian and Mitanni (153-175)
38. Bowls – Middle Assyrian and Mitanni (176-189)
39. Bowls – Middle Assyrian and Mitanni (190-200)
40. Burnished bowls (201-212)
41. Burnished bowls – Old Babylonian (213-228)
42. Bowls – Old Babylonian (229-241)
43. Bowls – Mitanni and Old Babylonian (242-253)

44. Burnished bowls – Old Babylonian (254-266)
45. Burnished bowls – Old Babylonian (267-282)
46. Burnished bowls – Old Babylonian (283-294)
47. Rough-based shallow bowls – Mitanni and Old Babylonian (295-318)
48. Rough-based shallow bowls – Mitanni and Old Babylonian (319-348)
49. Rough-based shallow bowls – Mitanni and Old Babylonian (349-372)
50. Shallow bowls – Old Babylonian (373-392)
51. Bowls – Old Babylonian (393-410)
52. Small bowls, lids and lamps – Old Babylonian (411-430)
53. Small bowls – Old Babylonian (431-456)
54. Small bowls – Old Babylonian (457-475)
55. Bowls – Late and Middle Assyrian (476-491)
56. Bowls – Late Assyrian (492-505)
57. Incised and decorated vessels (506-511)
58. Red-painted bowls – Old Babylonian (512-521)
59. Late third and early second millennium pottery (522-547)
60. Late third millennium pottery and early Khabur ware (548-566)
61. Hole-mouth bowls (567-578)
62. Hole-mouth bowls (579-588)
63. Cooking pots (589-596) and Late Assyrian deep bowls (597-603)
64. Deep bowls (604-621)
65. Deep bowls and jars – Old Babylonian (622-633)
66. Deep bowls (634-647)
67. Straight-sided beakers (648-674)
68. Nuzi ware (675-680)
69. Nuzi ware beakers (681-698)
70. Nuzi ware beakers (699-717)
71. Fine Nuzi ware beakers (718-724)
72. Undecorated shouldered beakers (725-752)
73. Undecorated shouldered beakers – Old Babylonian (753-777)
74. Painted shouldered beakers – Middle Assyrian to Old Babylonian (778-802)
75. Painted shouldered beakers – Late Old Babylonian (803-817)
76. Painted shouldered beakers – Mitanni and Old Babylonian (818-840)
77. Late and Middle Assyrian cups (841-851), Mitanni “grain measures” (852-862)
78. Painted “grain measures” – Mitanni and Old Babylonian (863-878)
79. Small shouldered beakers – Old Babylonian (879-898)
80. Miniature vessels (899-922)
81. Small jars and bottles – Late Old Babylonian to Late Assyrian (923-947)
82. Small jars (948-958)
83. Small jars and jugs (959-968)
84. Jars – Islamic/Parthian/Sassanian (969-975)
85. Jars (976-985)
86. Jars – Middle Assyrian and Mitanni (986-997)
87. Jars – Middle Assyrian to Old Babylonian (998-1012)
88. Jars – Old Babylonian (1013-1032)
89. Large jars – Old Babylonian (1033-1041)
90. Khabur ware jars – Old Babylonian (1042-1052)
91. Nuzi and Khabur ware jars and bowls – (1053-1064)
92. Strainers (1065-1104)
93. Potstands – Mitanni (1105-1119)
94. Potstands – Mitanni (1120-1134)
95. Potstands (1135-1164)
96. Fenestrated stands – Old Babylonian (1165-1172)
97. Late Assyrian stands, drain pipe and oven (1173-1177)
98. Tall stands – Mitanni and Old Babylonian (1178-1185)
99. Mitanni “pig pots” and miscellaneous vessels (1186-1196)
100. Tripod and footed vessels, incised grey ware (1197-1218)
101. Bowls and lamps (1219-1239)

Acknowledgements

The excavations at Tell al Rimah were sponsored by the British School of Archaeology in Iraq and, during the 1964-66 seasons, jointly by the University Museum, Philadelphia, when Mrs T.H. Carter acted on their behalf as Assistant Director of the excavations. We are deeply grateful for the interest and support of both institutions. We must also thank those other institutions whose contributions helped to make possible the work at Rimah. These include the British Academy, the Musée Royal d'Art et d'Histoire, Brussels, and the Ashmolean Museum, Oxford.

We owe a great debt to officials at that time of the Government of Iraq for their hospitable assistance, in particular to H.E. the Mutasarrif of Mosul Liwa, to Sayyid Ahmed al Mufti, Qaimaqam of Tell Afar, and Sayyid Selim al Jelili, Inspector of Antiquities for Mosul Liwa. The success of our work was largely due to the close and friendly cooperation, and the practical and scholarly advice, of the late Dr Faisal al-Wailly and Dr Isa Salman, Directors-General of Antiquities, and the late Professor Fuad Safar, Inspector-General of Excavations, and their staff. In particular we owe a considerable debt to our extremely competent and helpful Representatives: Sayyid Tariq al-Na'imi (1964), Dr Ghanim Wahida (1965), Dr Yasin Mahmud (1966), Sayyid Majid Abdullah ash-Shams (1967), Sayyid Manhal Jabr (1968), Dr Walid Yasin (1969 study season) and Dr Sabah Abboud (1971).

This volume owes much to Dr Julian Reade, who supervised the work in Area A from 1964 onwards and acted as Assistant Director in 1967 and 1971, and to Dr John Curtis who took charge of the work in Area C in 1971, and later collated the Iraq Museum catalogue numbers for the Rimah pottery in Baghdad. The bulk of the work on the pottery has been carried out by Carolyn Postgate, who was present during the 1968 and 1971 seasons, and who has been solely responsible for the plates and notes published in this volume. The conservation and recording of the pottery in the field was undertaken by Joan Oates in 1967 and 1968 (in the latter year together with Mrs Postgate), and in 1971 by Mrs Postgate. David Oates was throughout the Director of the excavations.

We wish to express our gratitude as well to all the other dig staff whose labours lie behind the information in this volume, in particular to Mr Nicholas Kindersley who was responsible for the construction of the very comfortable dig house in which we worked. Other members of staff were:

archaeologists: Dr Julian Reade (1964-71), Geoffrey Turner (1965-66), John Bellingham (1965, 1966), Andrew Tait (1965), Dr John Curtis (1971).

epigraphists: Miss Barbara Parker (later Lady Mallowan) (1964, 1966, 1968), Professor H.W.F. Saggs (1965), Professor D.J. Wiseman (1966), Dr Stephanie Page Dalley (1967), Professor David Hawkins (1967, 1971), Christopher Walker (1968).

conservators: Ann Searight (1964), Nan Shaw (1964, 1971), Elizabeth Dowman (1965-68).

photographers: Barbara Parker (1964, 1968), Nicholas Kindersley (1964, 1965); the late Edward Blandy (1968).

registrars: Elizabeth Dowman (1965-68), Dr Stephanie Dalley (1967), Dr Shereen Ratnagar (1971).

surveyors: Aubrey Trik (1965, 1966), Nicholas Kindersley (1964, 1965), Christopher Dalley (1967).

draughtsmen: Mrs Helen Trik (1965, 1966), Dr Jonathan Hodgkin (1967); Roger Whitney (1968).

Many visitors gave generous and welcome help: in 1964, Professor Jørgen Laessøe with the epigraphy, David Crownover of the University Museum with supervision on site and in the recording of finds, Dr David French in the survey of other sites in the area, and Dr Jeffrey Orchard with the registration of finds; in 1965, David Crownover and Sirii Woodward of the University Museum, Dr Dominique Collon who helped with the conservation, and Dr French; in 1966, the late Dr Richard (later Lord) Adrian, surveyor, Mr Anthony Robertson-Pearce and in 1967 Mr Peter Dorrell, photographers, Mr Crownover and Miss Mary Ellen Didier of the University Museum; in 1968, Dr and Mrs Richard Ellis, archaeologists. We were particularly happy to welcome in 1971 our old friends and distinguished colleagues Professor and Mrs Seton Lloyd. We also wish to thank Jackie Plaister and Sonia Lewis, Cambridge potters, for their invaluable suggestions, based on a study of sherds from Rimah, on probable manufacturing techniques. We also owe a debt of gratitude to the McDonald Institute for Archaeological Research, Cambridge and CIRCA Research and Reference Information Ltd., Cambridge for the use of their desktop publishing facilities during the lengthy preparation of this volume.

Introduction

The earliest investigations in northern Mesopotamia carried out by the British School of Archaeology in Iraq lay in the central core area of ancient Assyria, in settlements dating to the first millennium BC. In particular the work at Nimrud under the direction of Professor (later Sir) Max Mallowan revealed remarkable evidence, both archaeological and epigraphic, of the 9th to 7th century city, while excavation on the southern plateau of the tell produced a well-stratified sequence of Hellenistic occupation which remains a basic point of reference for this period in Northern Iraq. Despite the mass of evidence derived from 19th century, and indeed more recent, excavations at Nimrud, Nineveh and Khorsabad and the work of German scholars at Assur, of the whole course of Assyrian history, covering more than 1500 years, only brief and isolated periods are known in any detail, and of these our knowledge of the Late Empire was, in the 1960s, based primarily on evidence from metropolitan Assyria. At that time the first Assyrian kingdom, before Shamshi-Adad, was known in bare outline from inscriptions found in the early levels at Assur, but came to life only in the great commercial archives of the Assyrian merchant colony at Kaneš/Kültepe in Cappadocia.

The history of the first, shortlived empire created by Shamshi-Adad was known from the archives of his son and viceroy, Yasmah-Adad, found at Mari, supplemented by a much smaller collection of documents found at Šušarra/Shemshara in the Dokan valley on the easternmost borders of Shamshi-Adad's territory and a few administrative lists from Chagar Bazar. The ensuing centuries until the Middle Assyrian revival were an almost complete blank, emphasized rather than filled by the skeleton of the Assyrian King List. The evidence of the royal inscriptions from Assur, barely augmented by the only other excavated site that had at that time yielded Middle Assyrian texts, the provincial capital Šibaniba, modern Tell Billa east of Nineveh, yielded increasing, but at first sparse, information for this period.

The reason for this lack of information from Assyria itself was a practical one. The geographical and climatic advantages which made the plain around Nineveh a sufficient nucleus for the conquest of an empire have ensured intensive and continuous occupation of most of the obvious village or town sites. Old and Middle Assyrian settlements, not to mention the towns and villages of the third millennium BC, lie often all but inaccessible to the excavator beneath the massive remains not only of Late Assyrian but also of more recent buildings. The consequences for archaeology were not only the absence of direct information about much of Assyrian history, but that we lacked any well-dated sequence of material culture, in particular for the second millennium, by which the vicissitudes of settlement could be identified on the basis, for example, of survey data.

With this background, we decided in 1963 to look for more accessible second millennium and earlier material, which could only be sought in less favoured areas where individual settlements had had a shorter life, that is, outside the Tigris valley. Such considerations led us to look to the western borders of Assyria. We were particularly attracted to the plain south of the modern towns of Beled Sinjar and Tell Afar, where a pioneer survey by the late Professor Seton Lloyd in 1938 (*Iraq* 5, 1938) had drawn attention to the existence of a number of large sites, including several fortified towns which appeared to have been occupied only in the third and second millennia BC. It seemed to us likely that in this area of very marginal rainfall (Figure 1) the vicissitudes of ancient settlement might reflect, more sensitively than in the Tigris valley, the fluctuation of Assyrian power. Modern settlement, moreover, was sparse since this plain lay outside the boundary of cultivation in Ottoman times, largely owing to the fact that under the Ottoman regime government control over the Beduin was too lax to ensure the security of agricultural villages on the border of the Jazira.

Of the sites surveyed by Professor Lloyd and ourselves (*Iraq* 27, 1965) a number appeared to span the second millennium dark age from the Old Assyrian kingdom to the Middle Assyrian revival. During this time the towns of the plain apparently passed from the zenith of their prosperity to virtual extinction, a phenomenon itself of some historical interest. Of these ancient settlements the moderate-sized site of Tell al Rimah (Plate 1a: "The Mound of the Spears", Lloyd's Tell Irmah), 13 km south of Tell Afar, was chosen for excavation, which began in 1964 and continued until 1971. The objective was to flesh out the bones of second millennium history and archaeology in Assyria.

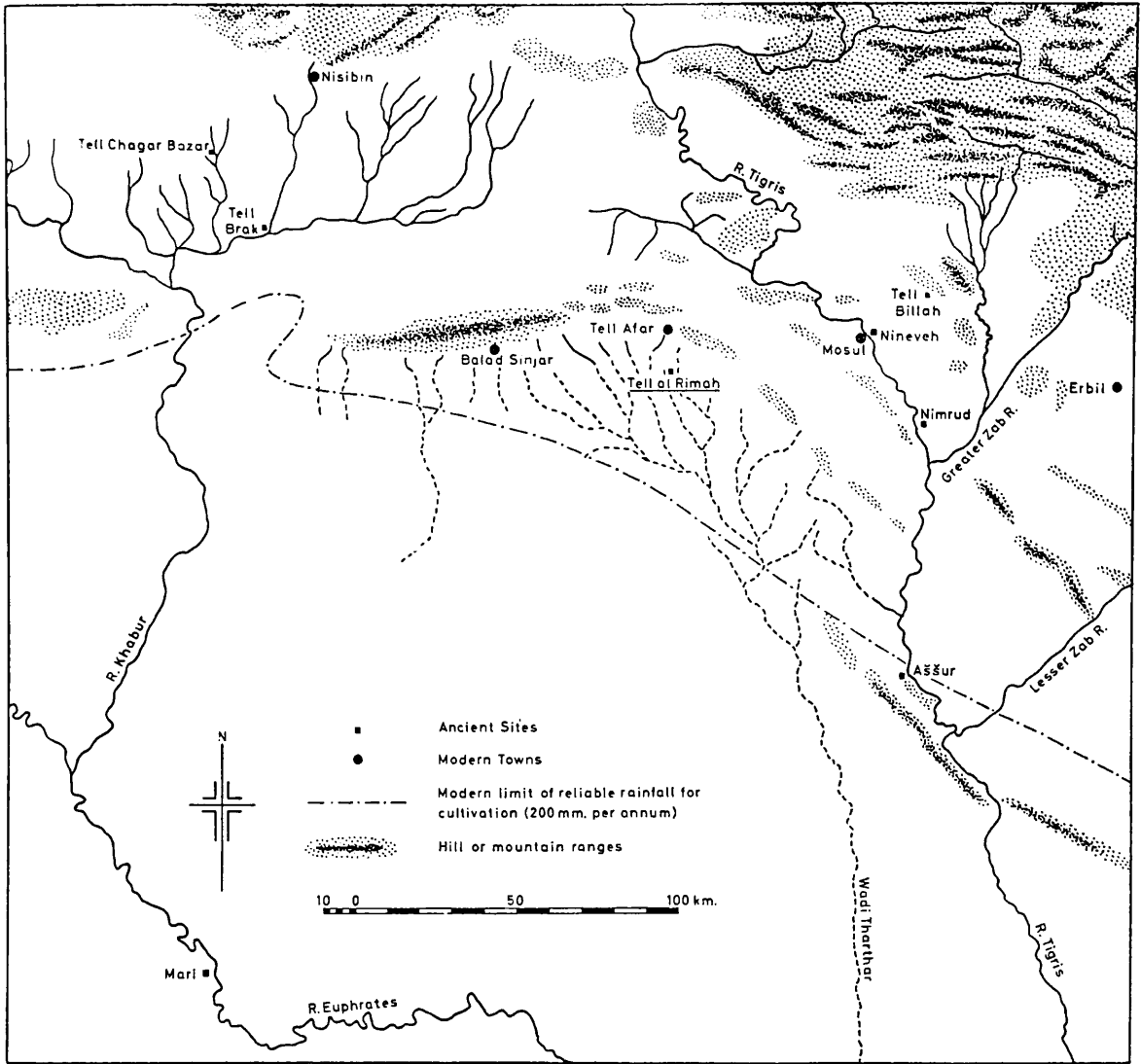

Figure 1. Map of Northern Iraq showing the position of Tell al Rimah

As its title suggests, this volume is devoted to the publication of the pottery from these excavations. Detailed interim reports can be found in the journal *Iraq* from 1965 to 1972. The seals from the site were published by Miss Barbara Parker (the late Lady Mallowan) (*Iraq* 37,39), while the tablets have been the subject of articles by Professor H.W.F. Saggs, Professor D.J. Wiseman and Dr Stephanie Dalley (*Iraq* 30), Mr C.B.F. Walker and Professor Nicholas Postgate (*Iraq* 32). A volume on the Old Babylonian tablets appeared in 1976 (Dalley, Walker and Hawkins, here abbreviated *OBTR*). Publication of the small finds is in preparation at the University Museum, under the direction of Dr T.H. Carter.

Chapter 1 provides a commentary on the stratigraphy of the site, in particular in areas A and C from which the bulk of the pottery derives. Roman numeral room numbers are used solely for Site C Palace Level 6 and Site A Temple Level 3, i.e. the major Old Babylonian occupation. A list of relevant batch numbers is to be found at the end of the volume; these should be understood and used in association with the fuller descriptions in Chapter 1. Batch numbers identify a particular locus on the site and the material recovered from it; a single locus, for example the floor or fill of a room, may have more than one batch number. Joining batches refer literally to different batches in which sherds from the same pot have been found. A list of the catalogued pottery is also provided; the museums in which these catalogued vessels are now to be found are also identified insofar as this information is known to us. Notes to the plates provide further information on the published pottery, with figures 16-48 illustrating the distribution of various pottery types. General comments on the pottery, and in particular the use of the terms Khabur ware and Nuzi ware can be found on pp. 51-56.



Figure 2. Plan of Tell al Rimah, with contours at 1.0 m intervals

The designation Old Babylonian may seem odd at a site in Assyria, but there is no satisfactory “Assyrian” label. Old Assyrian carries the implication of a very specific dialect, not found at Rimah. Indeed the tablets from Middle Bronze Age “Assyrian” Rimah are written in Old Babylonian, hence our use of the term. The dating of economic and administrative texts, however, follows the Assyrian eponym tradition, even when the rulers at Rimah recognise the suzerainty of Babylon.

A brief word should be said about chronology. The dates used in this volume follow the so-called Middle Chronology, with Hammurapi of Babylon reigning from 1792-1750 BC. True calendar dates are probably some 30 years older in relation to the Old Babylonian (Middle Bronze) dates. The Middle Assyrian dates closely approximate true calendar dates. The Babylonians dated by “naming” the year, normally with reference to some important event in the preceding year. Many of these year names incorporate invaluable historical information. The Assyrians dated by year-eponyms (*limū*). As a chronological convenience the year numbers of the better-known Old Babylonian kings are now used for clarity and consistency of comparative dating. For example, in the years between c. 1775-1760 the Mari and Rimah letters are often dated by reference to years in the reign of Zimri-Lim, the last king of Mari (see Charpin and Durand 1985, 306). Thus Aškur-Addu was certainly king of Karana during the years ZL 10’-12’ = Hammurapi 29-31 = Middle Chronology 1764-62 BC.

The Site

Rimah consists of an irregular polygon of walls enclosing an area some 600 metres in diameter (Figure 2). The walls are represented by a discontinuous ridge of debris, largely an earth embankment, but at one time this must have been surmounted by a mud-brick wall and towers; at the present day the surviving core stands in places to a height of over 6 metres. Traces of an external ditch show as modern crop-marks. The probable position of one gate is marked by a slight double eminence in the east wall, and another may be identified in the re-entrant angle of the north wall. Within the walls are low mounds marking buildings irregularly disposed about a central tell some 29 metres high and of more symmetrical aspect.

The modern water supply consists of a few wells in the seasonal watercourse that skirts the town wall to the north and east (Plate 10b), supplemented by rainwater pools in the winter and spring. The well water is today unreliable in summer and brackish at all seasons, as is all ground water in the Tell Afar region. Some wells were discovered within the ancient town, when presumably the ground water was both fresher and more plentiful than at present. Certainly the modern supply is quite inadequate to serve a community of any size, and it can be observed that the modern towns of Beled Sinjar and Tell Afar are located to the north, at the foot of the hill range where permanent springs are to be found. At the present time rainfed agriculture is marginal, but in good seasons high yields are possible. The distribution of second and third millennium cities would suggest the probability of more reliable rainfall at that time (perhaps related to more vegetation on Jebel Sinjar itself) associated with more adequate fresh water supplies south of the jebel.

The cuneiform tablets recovered from the site provide us with much economic information. In the second millennium the basis of the economy was clearly the cultivation of cereals, largely barley, and the herding of sheep, as it is today, and in the Old Babylonian period weaving was obviously an important industry, possibly under palace control. Tablets from Middle Assyrian contexts in the vicinity of the Great Temple reveal the presence of storerooms and stables for horses, associated with the Temple, and include merchants' archives recording loans of barley, presumably seed-corn, and of tin, of which a large quantity is said by one text to have been imported from eastern Anatolia by a local trader (TR 3019). Goods were transported by donkey and a Mari text refers to a caravan of 300 merchants and 300 donkeys arriving at Karana (one of two possible ancient names for Tell al Rimah) from Ekallatum (Išme-Dagan's capital on the Tigris near Assur) (*AEM I/2*, letter 432).

The ancient name of Tell al Rimah

A publication of the pottery is not the place for an extensive re-examination of the evidence relating to the ancient name of Tell al Rimah, but the question arises in the historical reconstruction of the archaeological sequence in the Old Babylonian Palace, from which much of the pottery derives and on which its dating depends. At the time of publication of the Old Babylonian tablets (1976) the available evidence seemed strongly to suggest an identification with the ancient town of Karana, well attested in the Mari letters and which together with the neighbouring town of Qatara [*Qaṭṭarā* (Charpin and Durand 1987), but spelled with a single 't' at Rimah] formed the focus of a small principality in the region of modern Tell Afar. Since 1976, however, much new evidence has been made available, for example from Mari, in particular *AEM I/2* (= *ARM XXVI*), in which the affairs of Karana and its king Aškur-Addu figure prominently. Moreover, two recent articles re-examine the evidence for the identification of Rimah. Both conclude that the site was more likely to have been Qatara than Karana (Charpin and Durand 1987, Eidem 1989), but agree that it was one or other of these ancient towns and that the evidence remains inconclusive.

Our cast of historical persons includes Shamshi-Adad I (ruled from c. 1837, king of Assyria 1813-1781 BC), who came to control much of northern Mesopotamia and Syria and whose governor Hasidanum is known to have been in charge of a large area including Rimah. The Mari letters also tell us of Samu-Addu, king of Karana at that time, who must have been a client prince. After Shamshi-Adad's death (c.1781), the kingdom of the twin cities Karana and Qatara flourished as an independent principality, drawn into the complex pattern of shifting coalitions and duplicitous intrigue revealed in the contemporary cuneiform letters. The Mari letters tell us of three further rulers of this principality, some

of whose cuneiform documents have survived at Rimah. The first is Hatnu-rapi, whom we now know to have been a king of Qatara (Charpin and Durand 1987, 134), but who spent some time resident at Karana when the troops of Eshnunna forced him to flee Qatara (late 1771 to early 1770 BC, ZL 3' to ZL 4', cf Charpin and Durand 1987, 132-3). Letters to him from Zimri-Lim (also dated ZL 3'-4') were found in Room II of the Old Babylonian Palace at Rimah. Two further rulers are associated with Karana and the family of Samu-Addu: 1) Aškur-Addu, king of Karana from c. 1765-1760, probably the son of Samu-Addu (Munn-Rankin 1956, 76), and 2) Aqba-hammu, who was married to Samu-Addu's daughter Iltani and was the *bārûm*-priest ("diviner") and Aškur-Addu's military commander. Under Aškur-Addu the political loyalties of Karana lay largely with Mari, ruled by Zimri-Lim; indeed the Mari letters show officials of that city present at Karana. The latest attestation of Aškur-Addu is dated 23.iii.ZL 12' (*ARMT* 25, 119), and it seems highly likely that he did not survive the end of Zimri-Lim, at least as ruler of Karana. With the fall of Mari (c. 1761) and the increasing involvement of Babylon in the North, Aqba-hammu changed sides – perhaps a reason for his falling out with Aškur-Addu – and became a vassal of Hammurapi.

Seal impressions from Rimah identify Aqba-hammu as a "servant of Hammurapi" (*OBTR* seal 14ii). Charpin (1985) has questioned the status of Aqba-hammu as "king" by analogy with the position of the diviner Asqudum at Mari. But the texts from Rimah show clearly that the former had succeeded his brother-in-law by the time of the largest surviving archive, that of his wife Iltani. Indeed a letter "to my mother" (Iltani) from her daughter (Belassunu) refers to "the king, my father" (*OBTR* 155). Moreover, Aqba-hammu pays tribute (*biltum*) to Hammurapi (*OBTR* 70). Eidem suggests that Aqba-Hammu began his independent career as a Babylonian governor, but that he was later raised to the status of vassal (1989, 72 ff). It seems reasonably certain that he was the effective ruler of Karana after the disappearance of Aškur-Addu, whatever his precise title. Neither Aškur-Addu nor Zimri-Lim is mentioned in the letters of Iltani, providing a probable *terminus post quem* for the archive, which on the basis of the *limu* evidence represents a minimum of 5 years. Thus the tablets themselves, and the pottery found with them, can be very closely dated to a period within the last decade of the reign of Hammurapi of Babylon; at the very latest they fall within a few years of his death.

It is clear from the letters that, at least after the time of Shamshi-Adad, Karana and Qatara were ruled and administered together, that is, they were not centres of competing kingdoms. A letter written to Iltani (*OBTR* 119) states quite clearly that she lives in Karana. Such evidence should, one would think, settle the question of the ancient name of Rimah. But the evidence is far from straightforward, in that the rulers of Karana and Qatara were peripatetic, that their administration was effected in both cities (indeed one document from Rimah treats the affairs of Karana on one side and Qatara on the other, *OBTR* 319), and that they would appear to have taken their business records with them when they travelled (*OBTR* 71). It is also clear from the surviving letters that Iltani and Aqba-hammu had more than one place of residence – not always Karana – and that they were often apart. A small number of economic documents from this archive record the issue of goods in Qatara, and one "before the king in Qatara" (213) (most do not mention the place of issue, presumably because there was no need to record the usual place of such transactions). The affairs of Qatara also comprise an important part of Iltani's responsibilities. The important question is whether Rimah was Iltani's primary place of residence or whether the Old Babylonian Palace excavated at the site was that of Qatara, to which she had removed many of her records, a possibility at least superficially suggested by the presence in Room II of letters of Hatnu-rapi. However, Iltani's documents cover not only a period of at least five years but a great variety of subjects. Taken as a whole they look less like tablets carried with her for some specific purpose than a part of her permanent files. Clay tablets are heavy, and one would expect the references to carrying tablets to signify only those records relating to the purpose of the journey. At Rimah no tablets were found *in situ*. Indeed, in general, tablets are recovered either in destruction levels (certainly the case with Iltani's archive) or when they have been used as fill on a building site (perhaps the circumstances of the Temple Stairway tablets (below, p. 21). Much has been made of the absence at Rimah itself of an archive of Aškur-Addu, a known king of Karana. But in archaeology absence of evidence is never evidence of absence. And if the refurbishment of the Rimah Palace marks the end of his reign, the absence of tablets is not surprising since little was found in the fill above the phase 3a floor (p. 30) beyond a few seal impressions, one of which was that of Aškur-Addu's personal seal.

Iltani's tablets were found in two rooms (VI and XIV), where they had been thrown or perhaps fallen from above. Although the surviving *limu* cover a period of at least 5 years, the bulk of the dated tablets bear the name of the *limu* Sabrum, in which year the Palace is likely to have been destroyed. Thus it is a reasonable assumption that the archive was stored in her primary residence, which letter 119 tells us was Karana. Charpin dismisses the latter evidence by suggesting that the reference is to the kingdom

of Karana in a general sense, not the city (1987, 140-41). Such a view is vitiated by ll. 5-6 in the same letter which refer specifically to the city of Adad and Geštinanna “where you dwell” (*ina āl wāšbāt*), i.e. Karana, where Geštinanna is known to have been the principal goddess. (*OBTR* 16 tells us that “Ishtar the lady of the enclosure” was the special deity of Hatnu-rapi.)

The presence of the Room II letters of Hatnu-rapi is the only truly persuasive evidence for an identification with Qatara (Middle Assyrian references to Qatara are largely to define the origin of the person concerned, i.e. they are “other” by contrast with “here, where we are”), but it remains to be explained why these surviving letters fall within and not at the end of his reign. We have no documents of the later years of Hatnu-rapi, and since Shamshi-Adad’s son, Išme-Dagan, chased Hatnu-rapi from Qatara, leaving the country in disarray (Mari letter A.649, Charpin and Durand 1987, 133), one would expect evidence of such disruption in the Palace at Qatara. Indeed shortly after the accession of Aškur-Addu a letter records measures taken against the partisans of Hatnu-rapi (*AEM* 1/2 letter 401). The presence of envelope fragments proves that at least one letter from Zimri-Lim to Hatnu-rapi was actually delivered to Rimah (*OBTR* seal 5). But we cannot demonstrate which letter it was, nor how many there were in all. Since we know that Hatnu-rapi was resident in Karana for part of ZL 3’ to 4’, and the letters date from approximately the same time (but see Charpin’s comments, 1987, 130 ff, pointing out that these letters would appear to bracket the time at Karana), a plausible scenario, that also accommodates the evidence of Iltani’s letters, is that when he fled Qatara, Hatnu-rapi may have taken with him the correspondence with Zimri-Lim, from whom he desperately needed help. Mari letter A.1180 actually specifies his presence in Karana in the 10th month of Zimri-Lim 3 (cf Charpin and Durand 1987, n. 31).

Thus the evidence for the ancient name of Tell al Rimah remains equivocal and inconclusive. But the fact that Hatnu-rapi is now known to be king of Qatara does not invalidate the evidence from Iltani’s letters, and there is at present no overwhelmingly convincing reason for an identification with Qatara in preference to Karana. We remain able to say only that Rimah was one or other of these two closely linked towns. The evidence from the Old Babylonian Palace will be reviewed in Chapter 1, against this historical background.

CHAPTER 1

The Excavations

Figure 2 identifies the four areas of Tell al Rimah in which excavations were carried out. Site B (Plate 10a) revealed Late Assyrian houses which were not further investigated, since we had already excavated Late Assyrian levels at Nimrud, and at Rimah our objective was the second millennium. Site D lay along the town wall and reproduced a second millennium sequence similar to that in the more extensively excavated Site C, discussed below, together with a number of graves from which the pottery is illustrated in the plates at the end of this volume (see also Plate 17 and pp. 46-49). Site A comprised the Great Temple and Site C various palatial buildings of Old Babylonian date succeeded by private houses and small shrines in the Mitanni and Middle Assyrian periods. We believe both the Great Temple and the earliest palace on Site C to have been built at the time of Shamshi-Adad. The two areas differ significantly not only in their function but in the fact that the Great Temple was situated on a high tell which had been occupied apparently throughout the third millennium whereas the Palace of Shamshi-Adad (Site C) was built on virgin soil. This suggests that the city wall too dates from the time of Shamshi-Adad, but we have no confirming evidence beyond the apparent absence of third millennium buildings in the outer town and the presence of middle to late second millennium structures built against its surviving earth bank and overlying (unexcavated) Old Babylonian buildings below.

Site A

a) The Great Temple (Plates 2-9a, Figures 3-5)

A Level 3 = Old Babylonian	(c. 1800-1600 BC)
A Level 2 = Mitanni	(c. 1550-1400 BC)
A Level 1 = Middle Assyrian	(c. 1350-1200 BC)

The Great Temple complex is constructed on an earlier tell some 5 ha in area. In its original conception it was apparently intended to incorporate a lower terrace surrounded by a temenos wall, and a free-standing arcaded stair leading up from the main entrance on the east to a second terrace on which the temple stood. A third high terrace or ziggurat was attached to the west face of the temple and approached from the roof (Figure 3). Only parts of this plan were carried out. First the temple was built on the levelled crown of the earlier mound (Plate 1b), but before the high terrace was finished there was a break in construction marked by the erosion of its upper surface. In the second phase the high terrace was completed and in the temple the courtyard was repaved (Figure 4; Plates 3b, 5b, 6a) but the original north and south entrances were blocked, evidently in recognition of the fact that the parts of the second terrace on to which they opened were never likely to be finished. This left only the east gate, with a paved area outside it, approached by the axial stair (*Iraq* 30, 1968, Pl. 31). This pavement and the stair itself were probably not completed until this second stage; certainly the retaining wall on the east face of the second terrace abuts on the stair, and both cut through some flimsy buildings which seem to have stood for a time outside the east façade. A group of tablets was found in the foundation trench for the retaining wall (including batch A600); these are dated by eponyms (*limū*) and it has been argued that they belong to the early part of the reign of Shamshi-Adad (Hawkins *OBTR* 1976, 195 ff; see now Whiting 1990). At the latest these tablets can be attributed to the earliest temple construction. In the latest phases of Level 3 the structure of the temple was found to be in need of reinforcement and walls were inserted that subdivided some of the rooms on the ground floor (*inter alia* Rooms XXI and XVII, cf. Plate 2c).

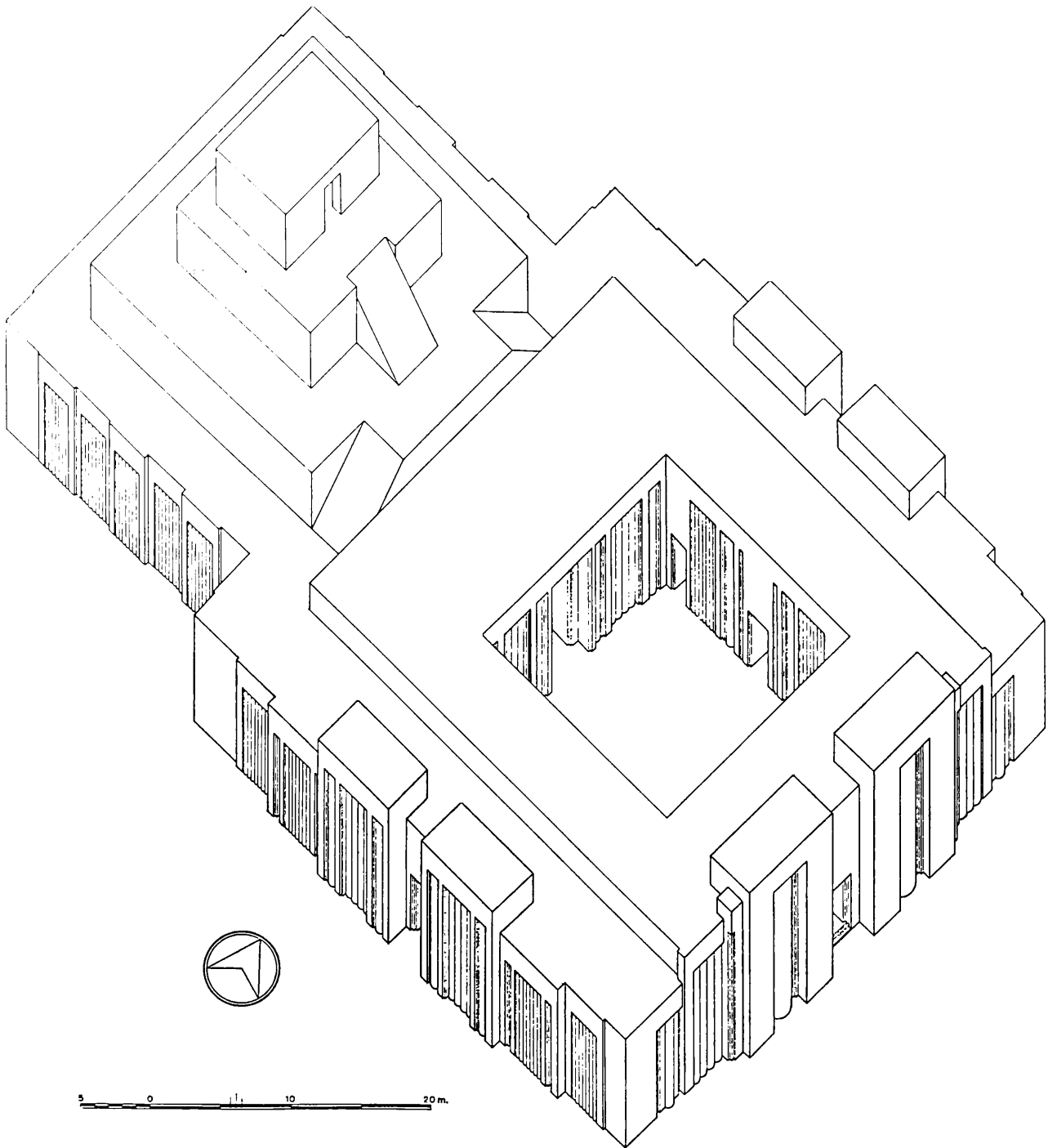

Figure 3. Site A Axonometric reconstruction of the Great Temple

Thus the earliest Temple reflects an original and highly ambitious monumental complex built at the time of Shamshi-Adad, and almost certainly under his patronage. Indeed, the extraordinary ornament on its 270 engaged columns provides a close parallel for the earliest version of the temple at Tell Leilan, which must also owe its existence to this ruler. At Rimah this earliest level, from which little material survives, is marked by the first brick pavement (38 cm square) within the courtyard (Plate 3b). Below the original floor were the stubs of earlier walls that had been cut down and packed with levelling fill. These bore no relation to the alignment of the Temple walls (Plate 5b). Pottery from this pre-Temple phase is recorded as Site A Level 4, and must date from the early part of the reign of Shamshi-Adad, or even earlier. Some 23 cm of deliberate packing underlie the pavement which represents the second phase of building described above (bricks 49 cm square), a level we attribute to the period of independent rulers following the death of Shamshi-Adad. There followed a period of careful maintenance and presumably moderate prosperity, almost certainly contemporary with the monumental Palace of Site C Level 6, discussed below, during which time the Temple floors were kept clean and both walls and floors were replastered. This ended in a destruction (probably to be dated sometime in the middle and certainly no later than early in the second half of the 18th century), which left a litter of pottery on the floors and which marks both a hurried abandonment of the building and the beginning of the decline in the temple's fortunes, referred to in the preliminary reports as the Level 3 destruction level. These early Level 3 floors, in particular in rooms on the north and west sides of the courtyard, were covered with a black plaster, coloured with an admixture of finely ground charcoal, while oval patches of black colour had been applied to the jambs of nearly all the doorways of the original building, features presumably of some ritual significance (cf *Iraq* 30, 1968, Pl.29a).

This sequence of pavements is illustrated in Plates 3b and 4a. The Level 3 destruction level is illustrated by pottery from, for example, Room XXV (batch numbers A555, A556) and Room II where a large quantity of pottery was associated with tablets TR 4002-9, administrative lists recovered from a jar underlying the reinforcing wall illustrated on Plate 3a; an earlier group of administrative tablets lay on the original floor at the east end of Room II, dated, like those from the east stair referred to above, in the Assyrian manner by *limū*. The same unusual personal name (Allašarum) occurs on both groups of texts, suggesting that they are not far apart in date. We should note that the slightly later Iltani archive (p.30) continues to date with Assyrian eponyms at a time when the suzerainty of Babylon was acknowledged (Dalley *OBTR* 31 ff). Thus dating by *limū* cannot be used to differentiate political allegiances and therefore the historical date. Indeed no Babylonian year names have been found on the early second millennium tablets so far recovered from the site.

Following the Level 3 destruction, which in the Temple had proved only a temporary interruption, there occurred a gradual build-up of debris, up to 1.90 m in depth, encompassing at least three later floors and indicating virtually continuous occupation until the abandonment of most of the original Temple, an event arbitrarily chosen as the beginning of Level 2. At some stage reinforcement walls were inserted into various Level 3 rooms (see above), the latest impoverished Level 3 occupation coinciding with the building of flimsy walls against the west façade of the courtyard; this phase in the north gate chamber produced a seal impression of Late Old Babylonian type (TR 2). The transition from the uppermost floor of Level 3 to Level 2c does not appear to represent any considerable lapse of time; indeed the separation would appear to have been no greater than that intervening between the late 3 floors themselves.

Level 2c represents an abortive attempt to rehabilitate the temple. As already noted, this is an arbitrary level in the sense that there is a continuous sequence of occupation, the distinction of phases resting solely on the architectural changes which altered the appearance of the shrine and ante-chamber, and suppressed the Level 3 structures that had enclosed the other sides of the courtyard. The remodelling of the shrine included the insertion of a barrel vault, still preserved to a height of 2.50 m above the spring and 4.60 m above the earliest floor associated with the remodelling (Plate 5b). By this time the shrine doorsill was some 2.50 m above the original temple floor; its floor continued to be renewed with black plaster. Level 2c ended in conflagration, while 2b and 2a represent a peaceful occupation in the Temple area, presumably in a period when Assyria accepted the suzerainty of Mitanni. There is some evidence to suggest that this phase too ended in destruction. Indeed a speculative but historically reasonable view is that the Mitanni may have been responsible for the initial Level 2c attempt to revive the fortunes of the great temple, by then fallen into poor repair.

During the later phases of Level 2 the temple courtyard was greatly reduced in size by the construction of small houses over and against the remains of the original walls (Figure 5). These rather flimsy buildings were again modified or replaced in Level 1. Their contents were in general domestic with the exception of Room 5 (Plate 2b), which contained an unusual number of frit and glass objects

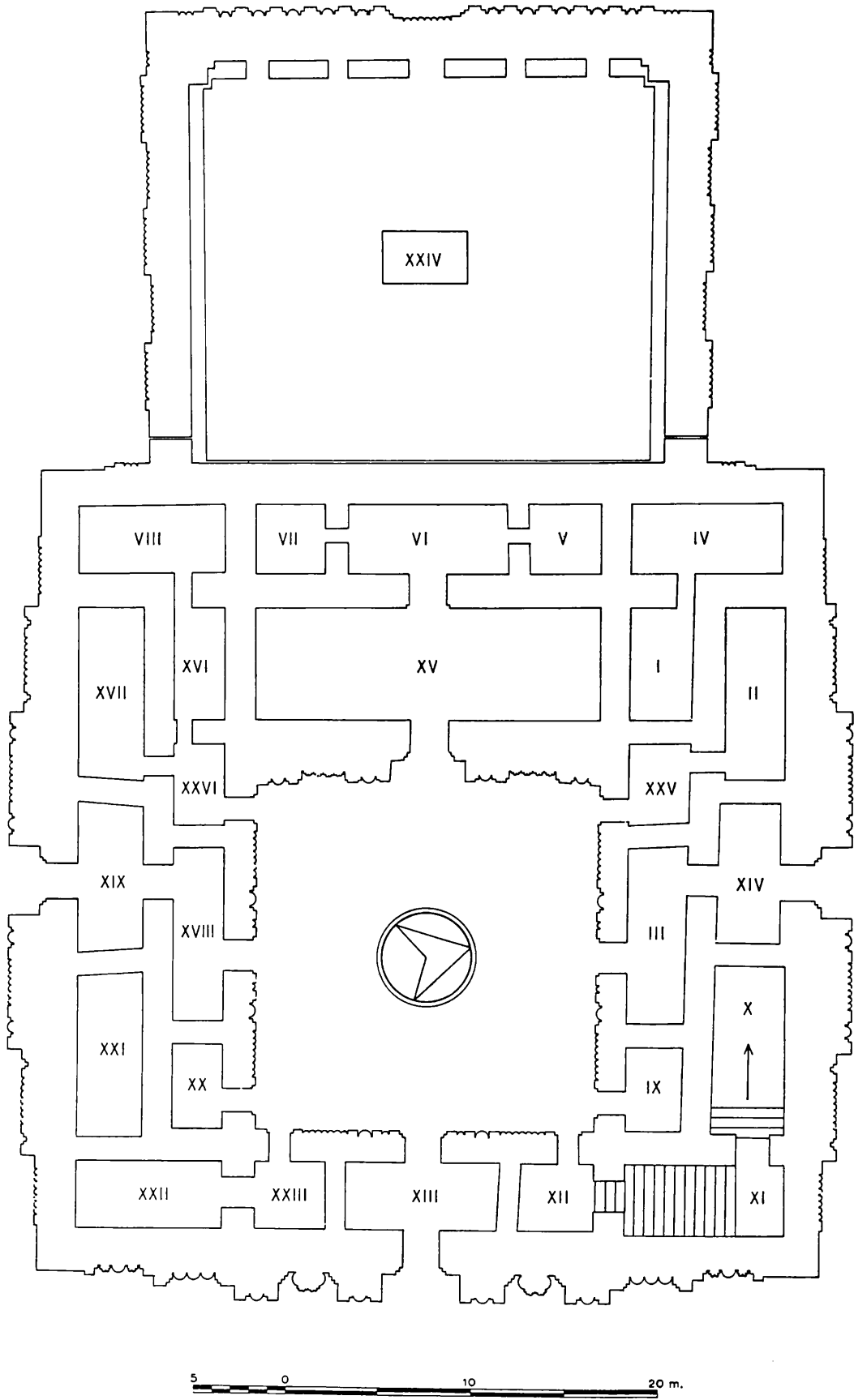

Figure 4. Site A Reconstructed plan of the Great Temple



Figure 5. Site A Level 2 plan above north temple façade

(Iraq 27, 1965, 73, and cf batch A69) and may perhaps have served as a shop for shrine offerings. From 2b onwards there was a cobbled path leading steeply upwards to the west between rooms 1 and 2 of the Level 2 plan. It was resurfaced more than once and, although its upper end had been eroded, we believe that it probably gave access to the top of the uppermost terrace (the original ziggurat), replacing the original stairs. At the point where the path passed between the west walls of Rooms 1 and 2, there appears to have been some sort of formal boundary, perhaps the entrance to a precinct on top of the ziggurat. At any event, when these walls were rebuilt in Level 1, foundation deposits, including a fine alabaster vase (Iraq 30, 1968, Pl. 35 a,b) were incorporated in the brickwork, while a crude limestone statuette of a bearded male figure (*op. cit.* Plate 35d) was found in the topsoil above Room 2. A similar though even cruder female statuette was found by the north door-jamb of the Level 1b shrine.

Level 2 seems to have come to an end abruptly, possibly no later than the middle of the 14th century (a radiocarbon determination for the destruction of a substantial Mitanni building on Site C provides a calibrated date of c.1450 BC, p. 37, below). During the interval that followed many Site A Level 2 buildings collapsed and on the ridge thus formed there appeared more small houses. These buildings are now heavily eroded but we know that the Temple shrine and ante-chamber continued in use. Within the antechamber a new floor was established and new door sockets inserted. Level 1b appears also to have been suddenly abandoned, and its debris was overlain by another floor (1a) virtually barren of objects, which may suggest a short-lived attempt at reoccupation. Level 1a was sealed by many metres of debris. Isolated walls at a much higher level have nothing to do with the Temple plan, though it would appear that in the Late Assyrian period some substantial building was erected on a massive terrace on top of the ziggurat, then long out of use (*Iraq* 29, 1967, 87). A number of miniature bronze weapons and implements were found (TR 3518-26), probably deriving from eroded foundation deposits. Other Late Assyrian buildings were found at the northeast corner of the ziggurat and over the north façade of the temple. Among the finds was an Aramaic ostrakon found in 1964 in topsoil above the shrine. Both the pottery and the ostrakon suggest an 8th century date, as does the stele from the better-preserved Late Assyrian shrine discovered in 1967 and discussed below (p. 41).

It is tempting to associate the revival in Level 1 with the re-emergence of Assyria as a power under Aššur-uballit I (1363-28). The end of Level 1b is well-dated to sometime around or just before 1200 BC by Middle Assyrian tablets found in 1964 and 1965 (Saggs 1968, Wiseman 1968) bearing *limū* of Shalmaneser I and Tukulti-Ninurta I. These had been stored in jars and were the archives of merchant families dealing largely in grain and tin. A find of related interest from the Level 1b courtyard was a T-shaped ingot of tin (TR 6) weighing about 1820 gm; an iron fragment was also found with the tablets (batch A228). This phase also produced important objects in glass and frit, in particular mosaic glass, female masks, cosmetics containers and rosettes, along with the very common beads and amulets (*Iraq* 27, Pls. 18-19, *Iraq* 28, Pls. 34-35). It is of interest that both Hurrian names and scribal forms continue to be found in the Middle Assyrian tablets, suggesting that a strong Hurrian element persisted both in the population and in the language of Tell al Rimah.

Another important Level 1 find was the orthostat of fine-grained limestone (Mosul marble) illustrated on Plate 8b. Badly weathered and clearly out of context, this piece must have been part of now missing ornament of either the Level 3 or Level 2 Temple. We favour the earlier date owing both to the standard of craftsmanship and the fact that there is evidence of stone ornament within the Level 3 phase of the building in the form of Mosul marble half-bricks (33x16x9.5 cm), recovered from the courtyard fill, which must have been set in the upper parts of the walls.

Other architectural features of note, found in the Level 2 temple, were the impost blocks illustrated on Plates 6-9. These include the figures of Lama (Plate 6b) and the earlier Humbaba (Plate 7a), each found set in a recess at the level of the phase 2c pavement. Again, these cannot be in their original contexts for their design (see Plate 9a) suggests that they had served as impost blocks, presumably for the lintels of one or more of the principal doors of the earlier Level 3 shrine. The hole in the projecting portion was designed to carry a round beam in front of the wall face, perhaps for a curtain. Details of their structure indicate that the two were not originally a pair (*Iraq* 29, 1967, 74-5). Their insertion at the 2c floor level represents a secondary usage, and during a late phase of Level 2 both were plastered over, bowl 167 having then been placed at the foot of the Lama relief. The Humbaba and bull-man pair illustrated on Plates 7b and 8a were not found during the excavations, but washed out of the east gate chamber during the heavy winter storms of 1970-71. The differences in style suggest that they may have been carved for a later phase of Temple reconstruction, perhaps that of the (probably) Mitanni builders of Level 2c.

Regrettably, the inscription on the Lama figure was too eroded to be read, and we therefore lack direct evidence of the deity to whom this great Temple was dedicated. However, a reference to "my lady" in the inscription allows the possibility of either Geštinanna, the goddess of Karana, or Ishtar "the lady of Qatara" (*OBTR* 154). It is Geštinanna who is mentioned most frequently in the letters to Iltani. However, the presence of a mould for a nude female figurine and a small terracotta bed within a Level 3 Temple workshop (Room VIII, cf *Iraq* 29, 1967, Pl. 37a-c), the later presence of glass plaques and bone needles bearing representations of a nude goddess (*inter alia*, TR 35, 88, 200), a gold disc bearing a repoussé eight-pointed star with linear rays (TR 2501), the remarkable faience masks (in particular TR 2738, *Iraq* 28, 1966, Pl. 34a), suggest the possibility of a temple dedicated to the cult of Ishtar. Unfortunately we are less well-informed of the symbolism of Geštinanna, who seems to have been an ancient goddess of the countryside.

b) Area AS The sounding on the south side of the central mound (Plate 9b, Figs 6-7)

AS phase 3 = Level A4 (early Khabur ware)

AS phase 2 = Level A5 (late third millennium BC)

AS phase 1 = Level A5 (late third millennium BC)

During the 1968 season we attempted to investigate the earlier history of the site, before the erection of the Great Temple, by a series of excavations in the modern shepherds' caves which riddled the south slope of the tell (Plate 1b). Work directly beneath the temple site was of course excluded by the unique nature of the building itself, and the cave interiors, on the lower slopes of the tell, had revealed extensive traces of floors and mud-brick walls together with pottery of third and early second millennium date. A trench was opened over the area of two caves, measuring roughly 19 m square (Figure 6). The excavations proved of particular importance for the early history of architecture, in particular in their evidence for late third millennium expertise in the techniques of vaulting (see Oates 1970 and 1990). They provided also vignettes testifying to the importance of the third millennium city, to which archaeological access was otherwise excluded.

It was clear that a number of vanished buildings had stood on the AS site in fairly close succession, but it was only towards the outer, southern side of the trench that a true occupation level was identified, marked by paved floors and ovens (phase 3, rooms AS 2, AS 4, Figure 6; 12 = oven on section, Figure 7). Unfortunately the debris overlying these floors was too close to the surface of the mound to be regarded as a sealed deposit. The earliest AS phase (1) was identified in AS 10 and AS 7. The fill within the walls consisted of compacted ash, bones and pottery, of which the latest sherds can be dated to the end of the third millennium BC (Pl. 27a). The phase 1 foundation levels were not reached, but it was clear that there were two, possibly three, phases of terracing operations designed to support buildings on the south slope of the mound. In the earliest extensive deposit excavated (pottery batch A663, from beneath the construction level of AS phase 2) were recovered a number of very distinctive bowls, occasionally with radial pattern-burnishing, of a type well-attested at Tell Taya in Level VII (Reade 1968, Plate 85:17,18 and notes) and at Tell Brak in the immediately post-Akkadian phase (see also Curtis 1982, Pl. 5, bottom row, where the top two rows illustrate Akkadian types also closely paralleled in the AS deposits at Rimah and in Akkadian levels at Brak). Sherds from batch 663 include Plate 27a and b.

The preliminary operation in the foundation of the AS phase 2 building is represented by the installation of arch 4 resting on corbels grouted into walls 2 and 3 (Figure 7). Two flexed skeletons were found just below the spring of the arch, on one of the rare trodden levels in the fill of these structures (AG 2-68, AG 3-68, pot 547, Plate 4b). In AS 1, and AS 8 to the north, a series of arches provided internal partitions delimiting small compartments roofed by domical vaults, providing the earliest known occurrence of the technique of "pitched-brick" vaulting (Plate 9b), the classic example of which is the well-known Arch of Ctesiphon. In both deposits the earliest sherds found within the various fills are in general of Akkadian date (*inter alia* pots 526, 552 and Plate 27c), while the profile and vertical burnishing of pot 544 suggest an even earlier third millennium attribution (cf Tell Brak, *Iraq* 53, 1991, Fig. 8). A small number of Ninevite 5 sherds have also been recovered, both from bricks and from the site, this general evidence suggesting occupation on the tell throughout most if not all of the third millennium.

To the north massive walls of very distinctive red mud-brick overlay the Area AS phase 2 buildings (not shown on plan); stratigraphically significant was the occurrence of a painted and incised jar (621) on a trodden level which in turn overlay the red-brick walls. This level was thus separated from the AS phase 2 vaulted structure by a substantial building, and is itself significantly earlier than the construction of the Great Temple. In stratigraphic terms these post-Ur III/early second millennium levels, i.e. Area AS phase 3, together with the material found directly below the Site A Temple, constitute "Site A Level 4". The use of combed ornament is particularly characteristic of late third and early second millennium levels (and is found as late as the Sinkashid Palace at Warka, UVB XX, 1964, Pl. 23). Those examples recovered from the AS trenches at Rimah derive from mixed fill, but on the evidence from Tell Brak the Rimah examples can be identified as both Ur III and Akkadian. The simpler, more sweeping wavy lines are in general Ur III (Plate 27a); the addition of punctate patterns and incised hatched triangles is typical of Akkadian examples. With the exception of pot 547, associated with grave AG 3-68, none of the Rimah AS phase 1 and 2 material was found in a primary context; it does nonetheless provide evidence for occupation of the site during the period of manufacture, i.e. in the Akkadian

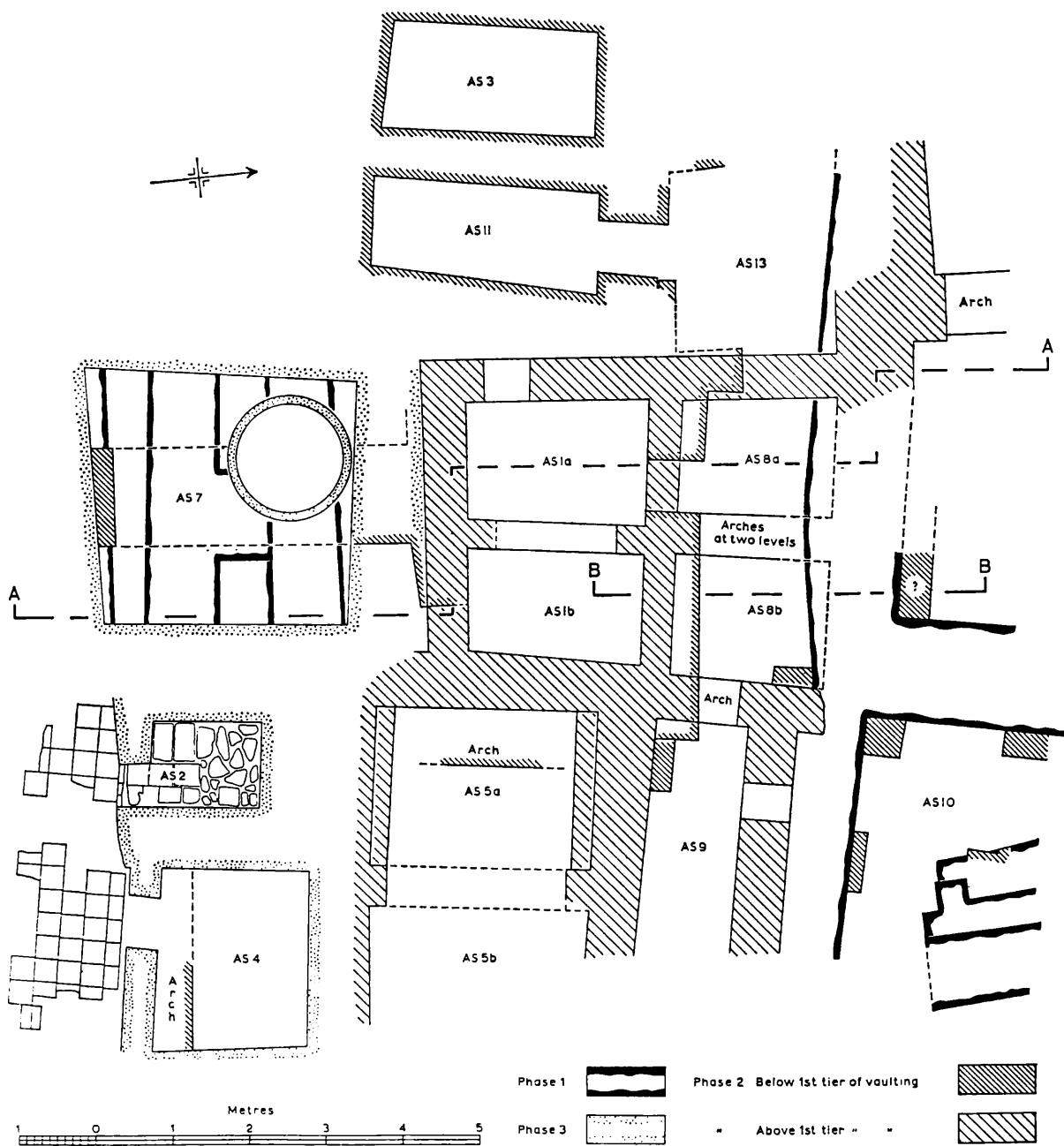

Figure 6. Area AS, Plan

and Ur III periods, and an approximate date for the architecturally important vaulted substructures. The third (upper) phase of construction in Area AS (= Site A Level 4) provides valuable evidence for the pre-Shamshi-Adad ceramic types that characterise the 19th century BC (e.g. pots 566, 621, 875, 880, 896, 1064). A more detailed discussion of the Area AS buildings can be found in *Iraq* 32, 1970; in the present text the dating of the third millennium pottery has been revised in accordance with more recent and more extensive evidence from Tell Brak.

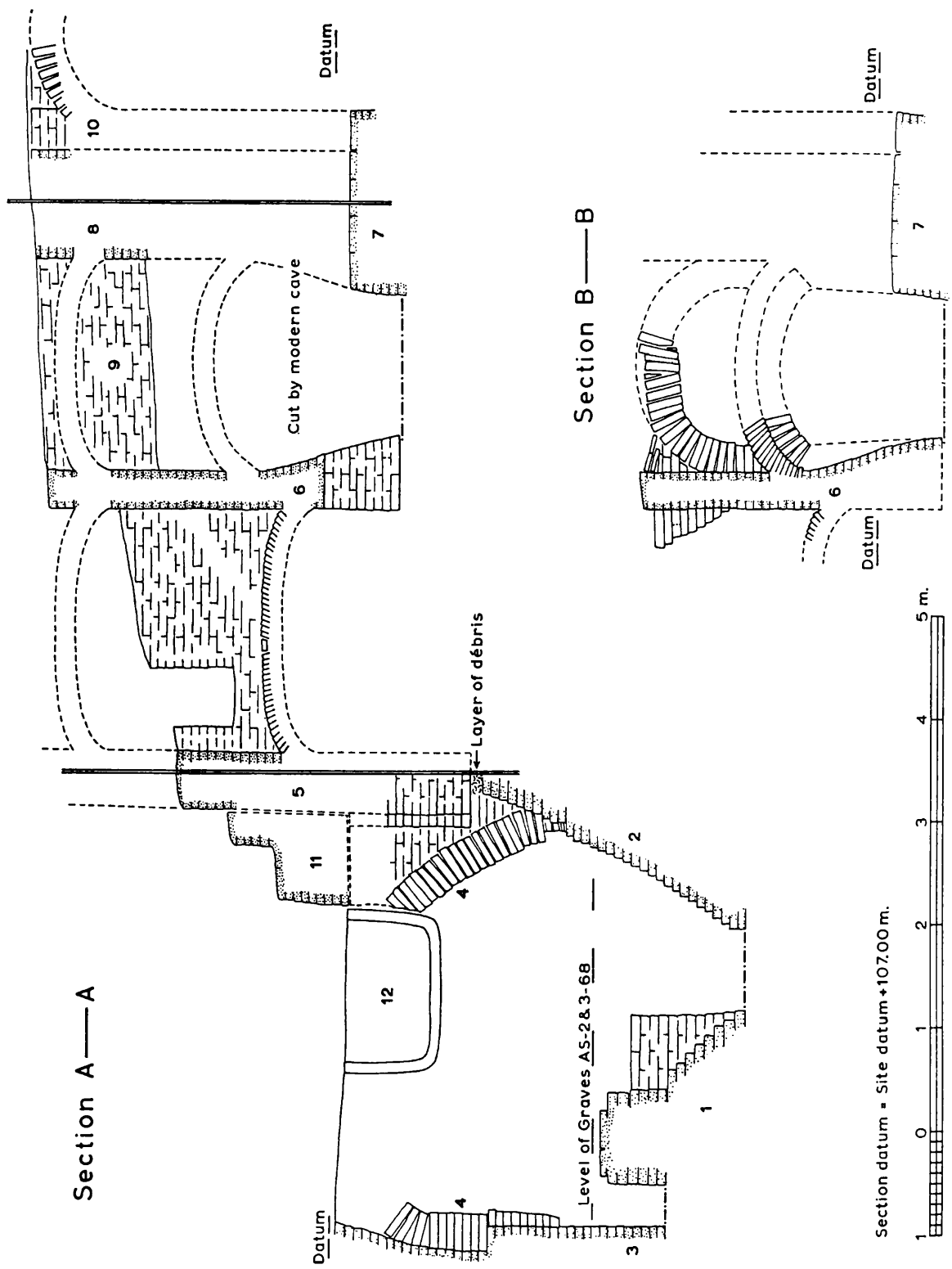

Figure 7. Area AS, Section A-A and B-B

Site C

a) The Palace (Plates 12b-14a, Figures 8-10)

C Level 7 = Palace of time of Shamshi-Adad

C Level 6 = Palace of time of Hammurapi and Zimri-Lim

The earliest building identified in the outer town area designated 'C' was a monumental administrative and residential complex referred to as the Palace (more accurately a series of palaces). Its foundations lay some 8 m below the modern surface. Three phases of construction were identified, the earliest represented by a three-room suite with mud-brick walls on massive stone foundations trenched into virgin soil. Since we could not remove the massive Palace 6 walls, the earlier plan was not immediately reconstructable; hence simply "below the Palace" descriptions in the batch lists, referring to the building phase 1 = stratigraphic Level 7 Palace. The principal room of this earliest suite (Room A, Figure 8), a "bent-axis" reception room, measured 10.2 x 4.2 m; it was entered through a doorway with triple reveals, the low dais at the south end of the room identifying it as a formal reception chamber (an axonometric reconstruction can be found in *Iraq* 34, 1972, Pl. 28).

In building phase 2 of the Palace additions were made on the east and possibly also the north sides of the suite, on a slightly different alignment (Figure 9); these walls remained to form part of the Palace in its final form (building phase 3, Figures 9,10). This latest Palace seems to have been much more ambitious than its predecessors, and the phase 1 reception suite was replaced by a grandiose throne-room and ante-chamber (Figure 10), well worthy of the epithet "shining palace" applied in a Mari letter to the Palace of Aškur-Addu in Karana (Jean 1939, 63). Two further courtyards were added, the larger of which formed the core of a new residential block. At some stage of its life this part of the palace was either briefly abandoned or damaged. During subsequent repairs some alterations were made, many walls were refaced and the black plastered floors of the throne room suite were relaid (building phase 3b, Figure 9).

By good fortune some of the seal impressions and tablets found on or below the floors suggest an overall time span for the sequence by their reference to rulers who can be approximately or precisely dated from other evidence (see pp. 18-20 for an historical summary). Below the earliest floor of the throne room (XIII) were two impressions of seals with inscriptions describing their owners as servants of Shamshi-Adad I of Assyria (*OBTR* seals 3,4). Beneath the upper floor of the adjacent room XII were seal impressions of servants of Hatnu-rapi (*OBTR* seal 9) and Aškur-Addu (seal 8), both contemporaries of Zimri-Lim, and of Aškur-Addu himself (seal 7). Sealings of his servants and those of his *bārûm*-priest (diviner), Aqba-hammu, were recovered from a gap between two adjacent walls that separate Corridor XXII from Room XVI, almost certainly in debris that was thrown there after the abandonment of the building (batch C395). In the latter texts there is no reference to Aškur-Addu, presumably his predecessor, nor indeed to Zimri-Lim of Mari; indeed Aqba-Hammu is the only "ruler" whose occupation of the Palace during its latest phase (3b) is securely attested. Thus the refurbishment of the Palace at the end of phase 3a, beginning of 3b, may well mark the point at which Aškur-Addu disappears (sometime around 1760 BC) and Aqba-hammu assumes control of Rimah.

Further evidence comes from the archive of Aqba-hammu's wife Iltani (a daughter of Samu-Addu) (Rooms VI, XIV, batches C78, C411, C420, C421). Letters from Zimri-Lim to Hatnu-rapi, king of Qatara, were recovered from Room II (C42, C46). Sealing fragments surviving from the envelope of one of Zimri-Lim's letters indicate that at least one letter was actually sent to Rimah. The implications of these letters are discussed above (p. 19); for the moment they and the letters of Iltani help to establish a close time scale for the occupation of the latest Palace from a period after the death of Shamshi-Adad to sometime late in or not long after the reign of Hammurapi. Thus the pottery from Site C Levels 7 and 6 is as closely dated as most archaeological material can be: on the so-called middle chronology Level 6 lies approximately between 1775 and 1750 BC, phase 3b lying within the final decade of the rule of Hammurapi, whose suzerainty was acknowledged by Aqba-hammu.

Thus historical reconstruction of Site C Levels 7-6 suggests that the earlier reception suite could well have served the need of one of Shamshi-Adad's district governors such as Hasidanum (identified by Whiting (1990) as a "resident commissioner") or of Samu-Addu, the contemporary ruler of Karana who was at most a client prince (ARM IV 26:5-6).

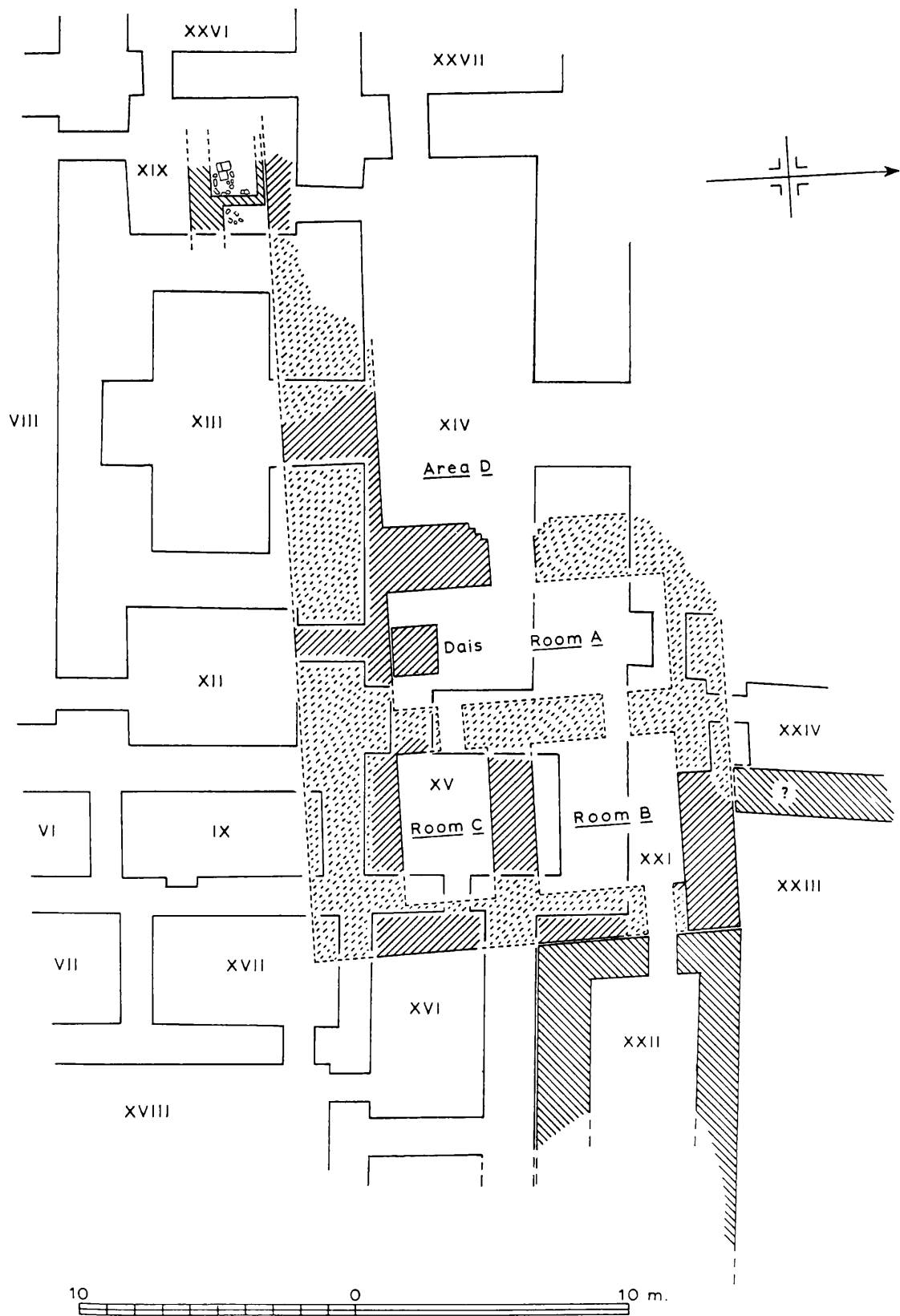

Figure 8. Site C Plan of buildings of Phases 1 and 2 of the Palace

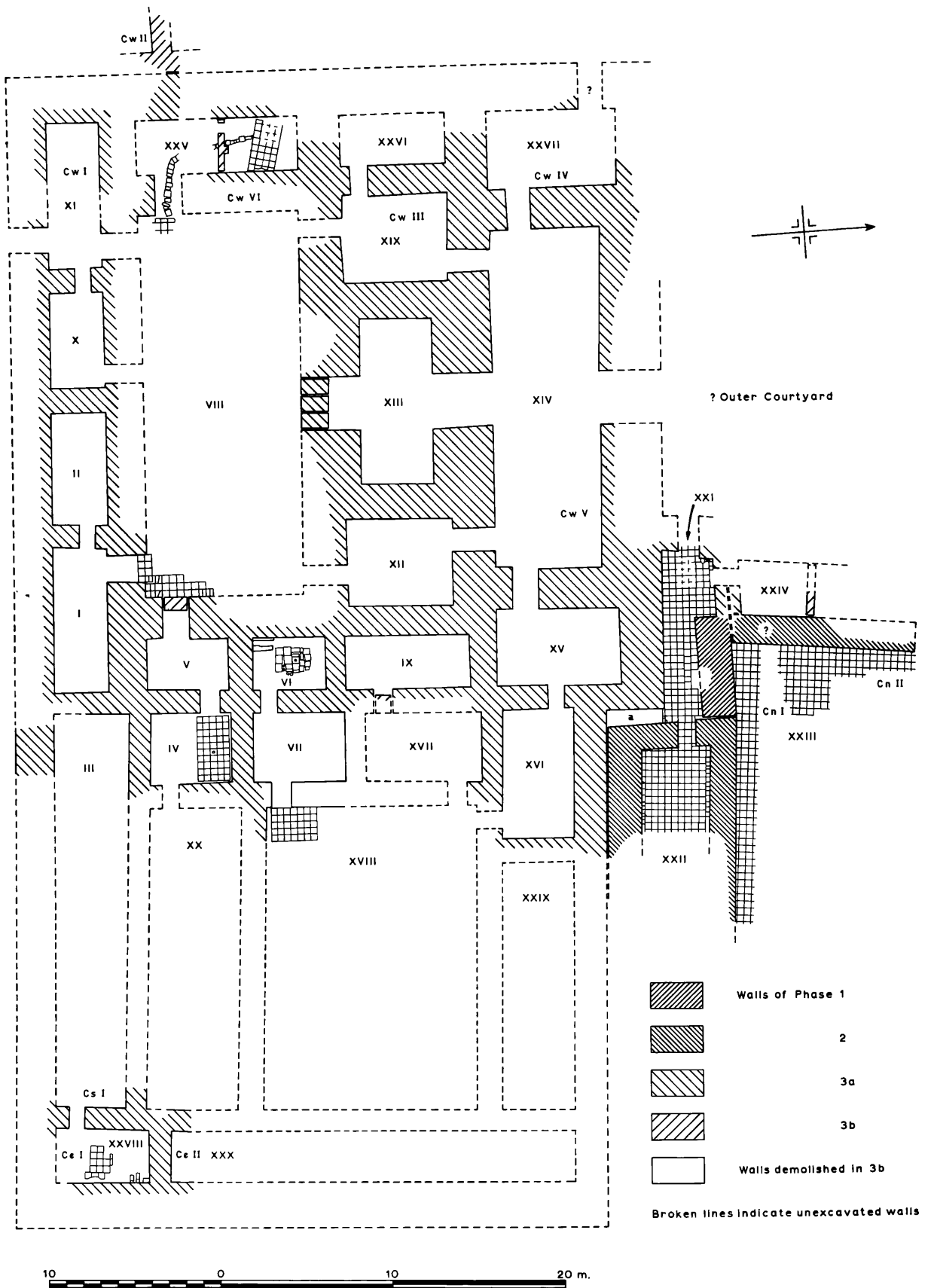

Figure 9. Site C Plan of the Palace and adjoining buildings, 1971

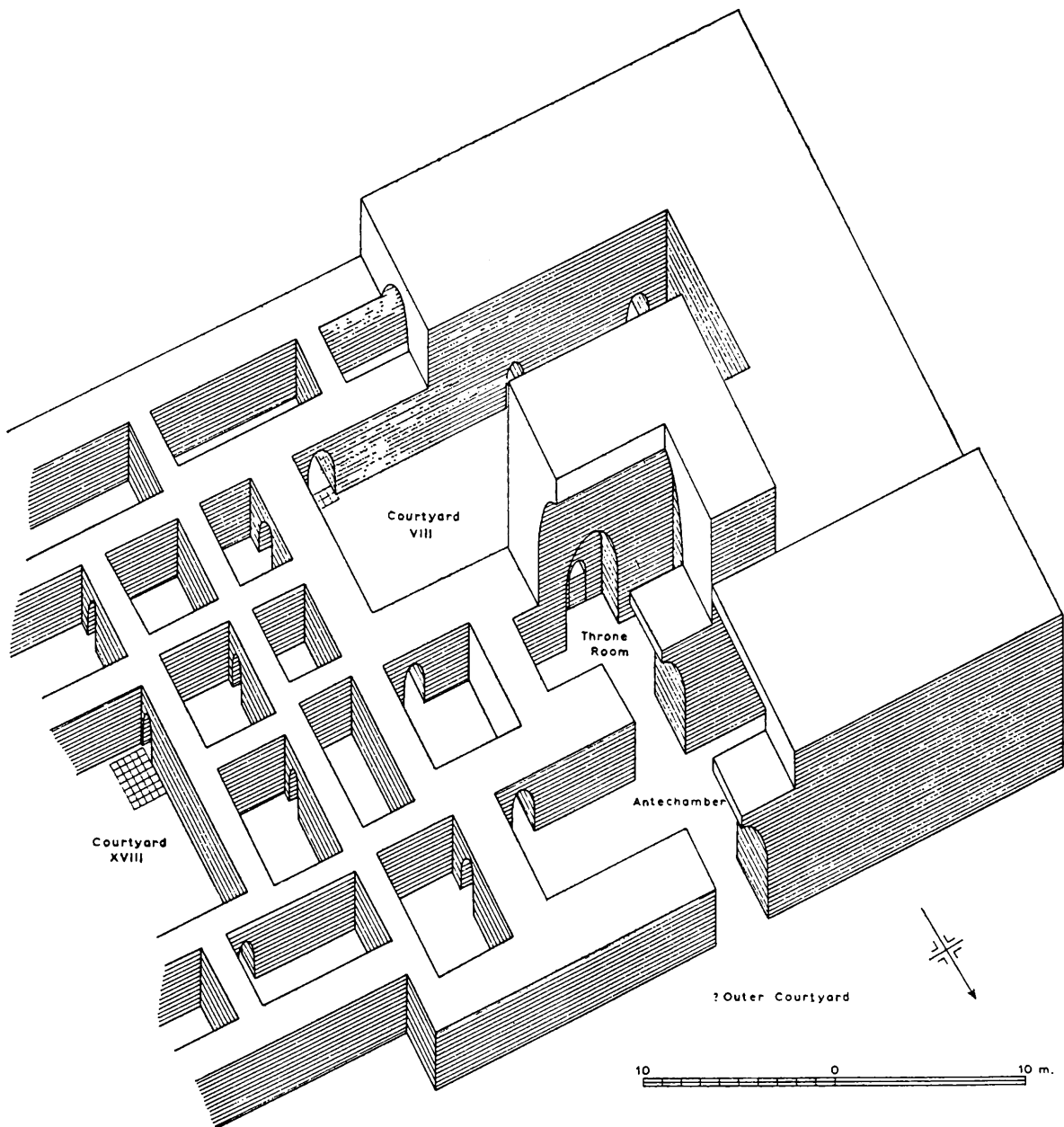

Figure 10. Site C Axonometric reconstruction of the western block of the Palace

The succeeding Palace (phases 2 and 3) must surely reflect the enlarged requirements and ambitions of the independent rulers of the city when, at some time after Shamshi-Adad's death, his sons lost direct control of the area. The monumental status of this Palace complex and indeed that of the time of Shamshi-Adad is confirmed not only by the tablets and the plans themselves, but also by the presence of large numbers of well-made, ornamental wall nails similar to those illustrated from Level 6 (Plate 25e).

PLAN OF KITCHEN IN LATE OLD BABYLONIAN BUILDING Site C Level 6a

LEGEND

1. Traces of plaster floor and plaster at foot of walls to a maximum height of 30 cm.
2. Mud brick bench, height 50 cm above floor.
3. Ledge 10 cm higher than 2.
4. Brick hearth with burning all round and on walls of bench.
- 5, 6. Mud bricks.
7. Mud brick bench, height 50 cm above floor.
8. Mud brick bench, height 30 cm above floor.
9. Hole cut into bricks of wall, 50 cm deep and from 90 to 125 cm above floor, roughly arched at the top.
10. Partial blocking of doorway.

POTTERY Batch numbers C673 C674 C679 C686 C696

Pot No	TR No	Type and remarks
A	1025	6039 Large jar set into bench, rim level with top of bench, containing several pots
B	1233	6045 Lamp
C	469	Bowl
D	~783	Beaker
E	~632	Deep bowl resting on top of bench, only partially set in
F	784	6025 Beaker
G	618	6035 Deep bowl
H	626	6041 Deep bowl
I	632	6043 Deep bowl
J	631	6042 Deep bowl
K	630	6044 Deep bowl resting on bench, only partially set in
L	1028	6037 Small jar set into floor with rim 10 cm above floor level
M	1021	6040 Large jar set into bench with rim 10 cm above top of bench, containing Pots W and X
N	785	6026 Beaker
O	435	6021 Bowl
P	824	6034 Beaker
Q	803	Beaker
R	812	6033 Beaker
S	468	6019 Bowl
T	1096	6024 Strainer
U	~1028	Small jar broken and out of place
V	~1031	Small jar broken and out of place
W	811	6028 Beaker found inside Pot M
X	810	6029 Beaker found inside Pot M
Y	~1177	Hollow oven base
Z	1031	Small jar broken and out of place

POTTERY FOUND INSIDE JAR A

Pot No	TR No	Type
AA	817	6031 Beaker
AB	816	6032 Beaker
AC	814	6030 Beaker
AD	412	6018 Bowl
AE	438	6022 Bowl
AF	519	6023 Bowl
AG	~467	Bowl profile
AH	~411	Bowl profile

POTTERY NOT FOUND *IN SITU*

Pot No	TR No	Type	Pot No	Type
~444	6020	Bowl	452	Bowl
801	6027	Beaker	455	Bowl
276	6036	Bowl	467	Bowl
1030	6038	Jar	813	Beaker
216		Bowl	815	Beaker
~216		Bowl	826	Beaker
255		Bowl	1011	Small jar
271		Bowl	1022	Jar
273		Bowl	1029	Small jar
278		Bowl	1156	Stand
281		Bowl	1167	Stand
436		Bowl		

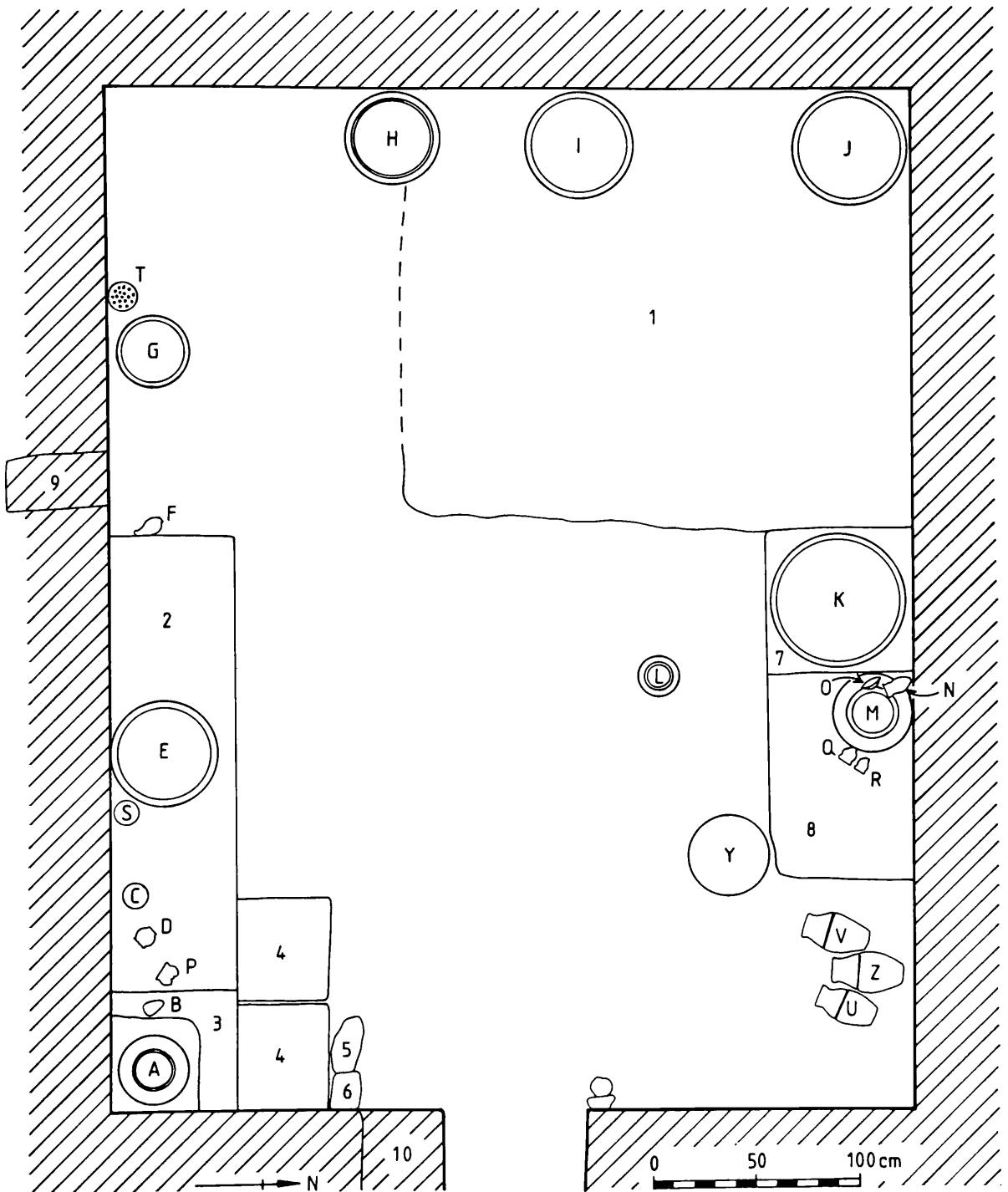

Figure 11. Site C Plan of "kitchen"

b) The Late Old Babylonian “kitchen” (Figure 11)

C Level 6a = Late Old Babylonian

After the destruction of the phase 3 Palace, perhaps contemporary with the Level 3 destruction floor in the Site A Temple sequence (p. 23), the Palace site was left deliberately unoccupied. Subsequently a major building was constructed on a massive platform a short distance to the south. The obviously more important part of the building, which had been situated on this terrace, has completely disappeared, leaving only a massive stone-built sewer that discharged northwards into the area overlying the Level 6 Palace, then being used as a rubbish dump (referred to in the batch lists as the “sump”, e.g. C549, C589, C928, C954; section Figure 15; C581 and C593). A contemporary building existed also to the north of the open area. Later, the open space was encroached upon, until by the 15th century it had become a tightly packed complex of houses and small shrines. Although no trace was preserved of the superstructure that stood on the platform, one wing extending northwards to overlie Palace Rooms II, X, and XI had survived. Here were found three vaulted chambers of apparently domestic character. They yielded a quantity of pottery including some vessels painted in a style intermediate between the Khabur ware of the Palace period and the painted wares of Mitanni times. Of the greatest importance was the material from the room designated the “kitchen” (Figure 11), which constituted the single largest deposit of pottery found *in situ* at Rimah.

Unfortunately we have no specific dating evidence for this building, but it must have been constructed some considerable time after the abandonment of the Level 6 Palace, while an extension of the associated platform shows that it had been enlarged on more than one occasion, implying a reasonable life span. We would suggest a construction date sometime towards the end of the 18th century, possibly even later, but this is little more than an informed guess. Our inability to be more precise is particularly unfortunate, since the types of decoration found on the pottery from the “kitchen” herald the changes generally thought to be characteristic of the Mitanni ceramic repertoire (cf pp. 55-56). Indeed we cannot actually prove that the Level 6a structure was not built under the aegis of the early Mitanni kingdom, but we think this is highly unlikely, especially since the kitchen walls rest directly on the Level 6 Palace. Whatever its date, it cannot be far removed in time from the latest Level 3 floors in the Temple and its Level 2c reconstruction. The absence of Nuzi ware (present in Site A Level 2c) and similarities to late Old Babylonian material from Brak persuade us that a Late Old Babylonian date is by far the more likely, though there is little evidence from the Temple to suggest a prosperous power established at Rimah at this time. It is perhaps worth recalling that in Assyrian tradition the disappearance of Shamshi-Adad’s dynasty at Assur was followed by a period of confusion – the “seven kings, sons of a nobody” of the King List – and then by the restoration of authority under Belu-bani, an event which must have occurred in the late 18th or early 17th century and may well have reflected a general return of stability in the north.

If we are right in our attribution of the 6a building to a date within the 17th century, the pottery from it shows not only a gradual stylistic development from classic Old Babylonian to Mitanni Khabur ware but also the introduction of a number of features thought to be characteristic solely of the latter, for example the very distinctive vessels ornamented with birds, found not only here but also associated with the latest Level 3 floors of the Temple sequence, evidence of some importance for the development of second millennium ceramic styles (discussed in more detail on pp. 52-56).

An object of considerable interest recovered from an adjacent Level 6a structure and lying beneath a secondary wall repair was a circular tablet recording the erection of a palace in Razama, a city probably to the south of Rimah and closely linked with Karana in the Mari letters – yet a further red herring in the quest for the ancient name of Tell al Rimah. In fact, this small and potentially misleading document must have been a trophy removed from Razama by some unknown member of a presumably victorious Old Babylonian army from Tell al Rimah (see also *Iraq* 32, 1970, 4-5, 27 ff and Pl. 4b).

c) Rimah under Mitanni suzerainty (Figure 12)

C Level 5 = Mitanni

Two main phases of Mitanni occupation were identified on Site C, referred to in the batch lists as 'a' (upper) and 'b' (lower). Both phases show some signs of heavy burning, though these are not consistent over the site. The early excavations on Site C revealed an extensive Level 5 building, which had been enlarged on at least two occasions. It had been hastily abandoned, perhaps even partly destroyed by fire. A radiocarbon determination from the burnt destruction debris gave a calibrated date of approximately 1450 BC (P-844). In 1967 a small Level 5 shrine (Room 81) and a storeroom with jars *in situ* were found on the north side of the open, sump area. The well-known glass beaker (*Iraq* 30, 1968, Pl. 35c) lay in the top of one of the large jars of the storeroom, immediately beneath the south wall of an overlying Middle Assyrian shrine (Room 43, Level 4). A glazed wall nail found in the vicinity may also have come from the Mitanni shrine (cf also Plate 25b,c). Both the shrine and its overlying fill contained large quantities of metal objects, glass and frit. These buildings had been constructed on a thick layer of levelling fill consisting not only of pottery, presumably both Late Old Babylonian and early Mitanni in date, but of quantities of other debris, bricks, wall nails, etc, which had been used to fill in the so-called sump area over which the Mitanni buildings were situated (batches 28-30).

The bulk of the Level 5 material comes from what appear to have been relatively affluent houses; several rooms contained large quantities of frit and glass objects, which were also found extensively among the levelling fills on which the Middle Assyrian houses were subsequently built. Room K contained a shallow brick-built hearth identical with examples found in the Mitanni Palace at Brak (*Iraq* 49, 1987, Pl. 34). A large deposit of potstands (C677, C688) was found in the courtyard to the south of this room, and in the connecting doorway. On the floor of another Mitanni house (batch 470) were four potstands together with a unique bowl with ram's head spout (Plate 20f). A small number of Mitanni graves were found associated with houses in Areas C and D; of considerable importance is the Mitanni multiple tomb, Plate 16, discussed in more detail on p. 45.

d) Middle and Late Assyrian settlement (Figures 13, 14)

Site C Levels 4-2 = Middle Assyrian

Site C Level 1 = Late Assyrian

The Level 5 Mitanni structures were replaced after no great interval by a complex of new buildings, some retaining earlier wall alignments and continuing the pattern of private houses and small shrines (Figure 13). These buildings remained in use for a considerable period, during which they were repaired and extended on at least two occasions, the floor levels rising by as much as a metre. As in the contemporary site A Temple excavations, large quantities of glass and glazed objects were recovered from these levels and the fill underlying them, some fourteen glass vessels having been recovered in one small area in 1968 (batch C248, cf *Iraq* 32, 1970, 3, Pl. 3). A Middle Assyrian shrine (room 43, Plate 12) was built 20 m southwest of the Phase 5 shrine; a cooking pot (590) was set in the floor of the small room north of the shrine. In Area 106, not far from the Mitanni courtyard with potstands (above), was another large group of stands (batches C319, C320). Such courtyard contexts are clearly a reflection of the function of the potstands in supporting containers of foods or liquids on a large scale. Between Level 2 and Level 1 there was both a considerable break in time and a change of alignment. Two main Level 1 building levels were identified, containing courtyard houses of considerable extent and substantial construction. As in Area A, these were often heavily eroded, their plans fragmentary (cf section, Figure 15). A number of graves were found in association with these Late Assyrian houses (Plate 18 and p. 45). One further Late Assyrian building must be mentioned, the temple which in the late 9th or early 8th century BC had been built into the northeast corner of the ziggurat (Plate 14b). This provides our only secure dating evidence for the Late Assyrian re-settlement of Rimah.

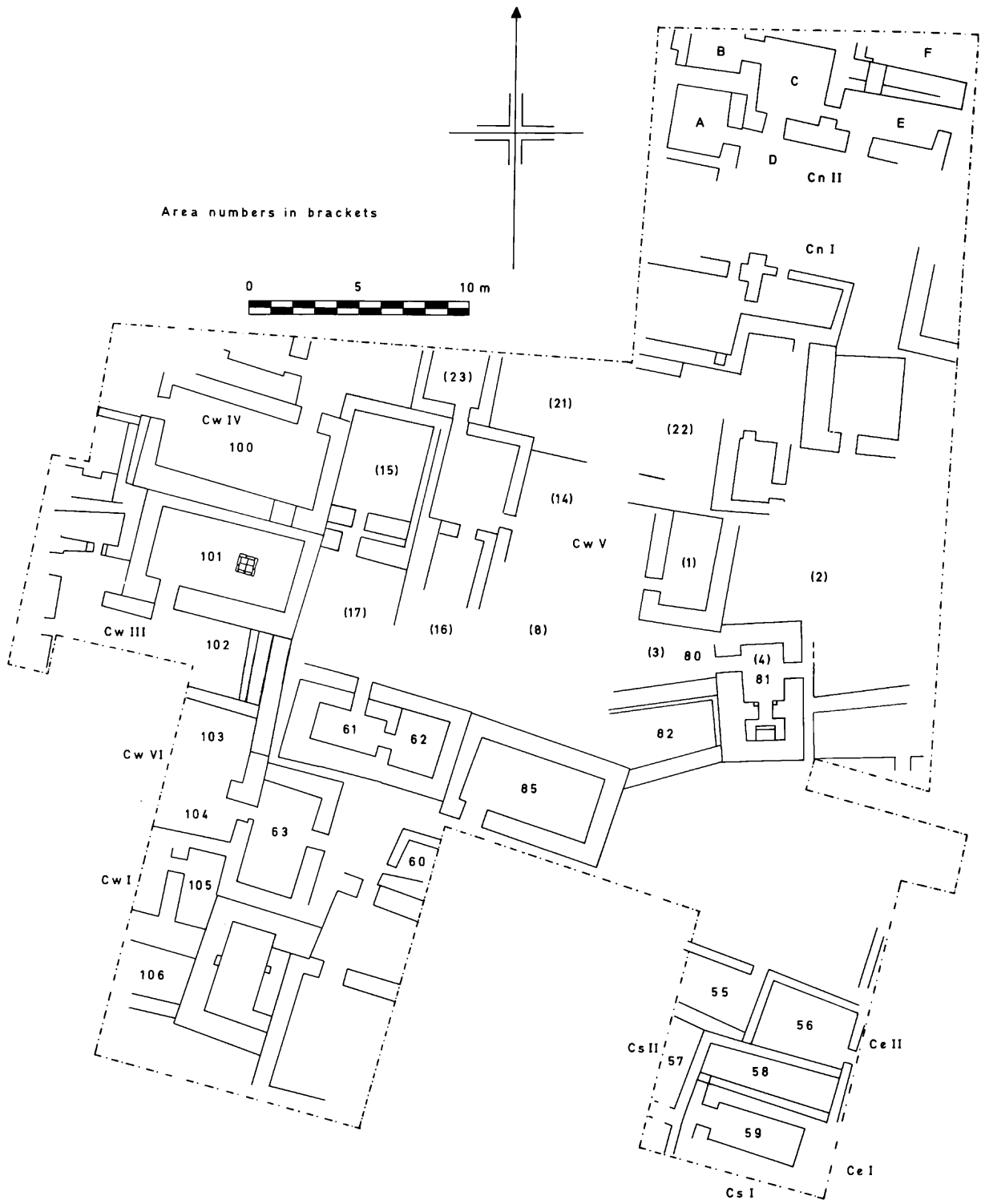

Figure 12. Site C Level 5 Mitanni



Figure 13. Site C Level 4 Middle Assyrian

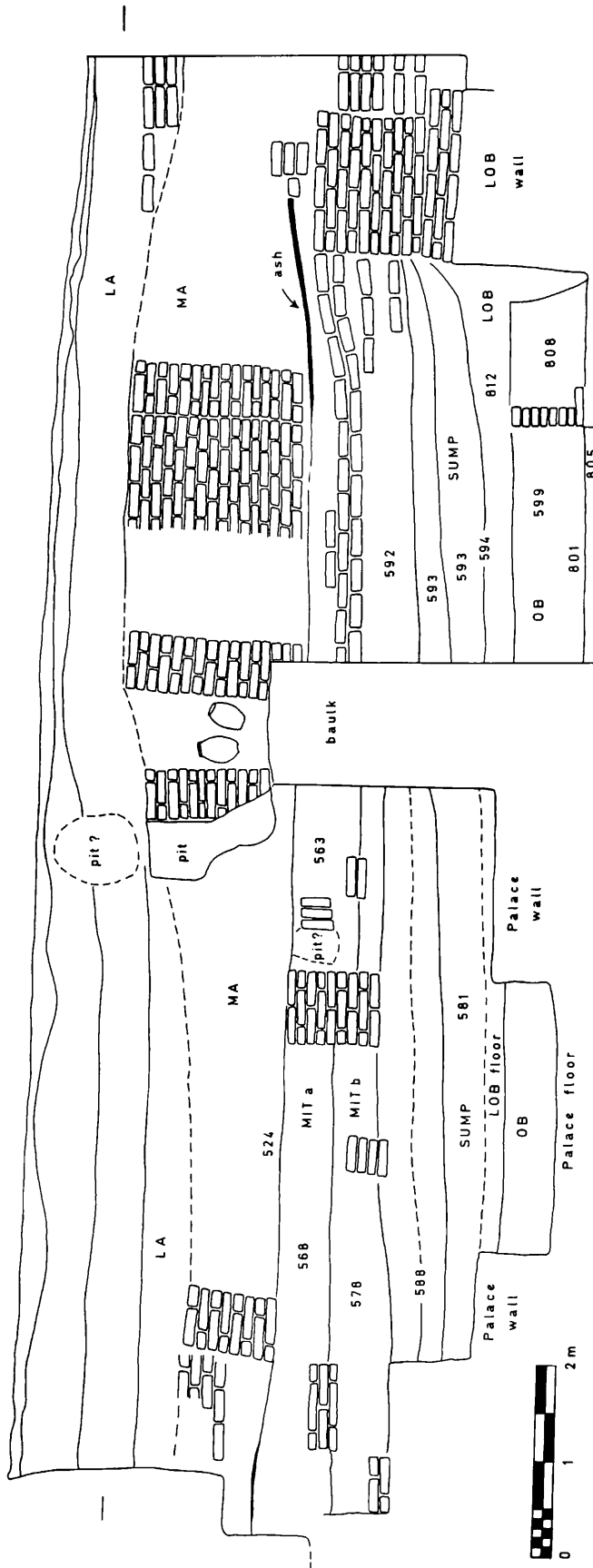

Figure 14. Site C section, squares Cn I/II west face

Site A

The Late Assyrian Temple (Plates 14b, 15, 26, Figure 15)

This temple (Figure 15) was the most important Late Assyrian building found at Rimah. In plan it is typical of the long-room layout well known from Assur, Nimrud and Khorsabad. The main entrance opened onto a paved terrace and was flanked by projecting towers. The temple had been temporarily abandoned at some stage of its history and then repaired; its final abandonment was also sudden. Evidence of deliberate damage to the building at the time of its desertion was afforded by the discovery of a mass of fragments of one or more large bitumen reliefs that once adorned its walls; portions of wings of over a metre's span as well as claw feet and the legs of an animal, of similar scale, were identified. A badly weathered limestone altar may have stood just outside the entrance (*Iraq* 1974, Pl. 28,5) while the stone sculpture found within the temple included four limestone orthostats (Plate 26b) and the stele, discussed below, erected not long after 800 BC. Among the pottery found in the temple the most notable pieces are the glazed jar (Plate 26b, jar 948), a glazed compartmented dish (Plate 25f), a chalice with a ribbed pedestal base (pot 1214) and three offering stands found in the cella (Plate 97). The temple and its contents are discussed in detail in *Iraq* 30, 1968.

The inscribed stele was erected by Nergal(Palil)-eresh in the name of Adad-nerari III (810-783 BC) and dedicated to "Adad who dwells in Zamahu" (Plate 15). The text mentions the receipt of tribute from Jehoash (Joash) of Samaria who came to the throne about 798 BC, so the stele must be dated in the very early years of the 8th century and strongly suggests that Zamahu was the name of Tell al Rimah at that time. It also records the foundation or re-foundation of ten towns and over three hundred villages in the large province of Rasappa of which Nergal-eresh was governor. Zamahu is not included in the list and was presumably reoccupied, under its new name, some years earlier, perhaps as a prelude to the programme commemorated in the stele which must represent a resettlement of a large area of the Jazira.

We would therefore tentatively assign the beginning of the Late Assyrian settlement to the late 9th century. The date of its abandonment is much more difficult to determine. We have found only two building levels of Late Assyrian houses on Site C, which at most would have spanned a period of perhaps 60-80 years, and a single level in Site D. Unless there had been a lengthy gap in the Late Assyrian occupation of the site, perhaps suggested by the temporary abandonment of the temple but not by the houses which appear to represent routine reconstruction rather than interrupted occupation, this would suggest that Rimah came to an end well before the fall of Assyria in 612 BC. Unfortunately the upper levels on both Sites C and D are heavily eroded (cf section, Figure 14), so that the building evidence is not as informative as that from earlier strata. Some of the pottery shows a general similarity to the late 7th century material published from Fort Shalmaneser at Nimrud, but the parallels are not precise (see p. 57). Judging by the valuable objects that remained in the destroyed Late Assyrian temple, the site came to an abrupt end.

On the existing evidence, it seems inconceivable that occupation at Tell al Rimah could have continued into the 7th century. Nor is it likely that a site so close to the Assyrian heartland should have been abandoned in the second half of the 8th century when strong government had been restored under Tiglath-pileser III and his successors. There remains the period of weakness from the death of Adad-nerari III in 783 to the revolt in Kalhu in 745 which resulted in the assassination of Aššur-nerari V and the usurpation of the throne by Tiglath-pileser III. We can only suggest, without supporting historical evidence, that settlement at Tell al Rimah ceased towards the end of this time, which would allow a span of some 60 years for its Late Assyrian duration. It is even conceivable that its abandonment was due in some measure to the close association of Nergal-eresh with the family of Adad-nerari III, demonstrated by the fact that he held *limu* office as governor of Rasappa under both Adad-nerari (803 BC) and his son Shalmaneser IV (775 BC), both of whose successors were also sons of Adad-nerari.

The declining power of the monarchy during this period permitted the rise of powerful officials like Nergal-eresh himself, with long tenure of important offices and each, doubtless, with his own considerable body of partisan support. Their rivalries must have contributed largely to the revolt in Kalhu, and the defeat of the faction which supported Aššur-nerari V, and of which Nergal-eresh must have been an early leader, may explain the almost complete obliteration of his name and the record of his achievements on the stele (Plate 15 and *Iraq* 30, 1968, p.128 ff).

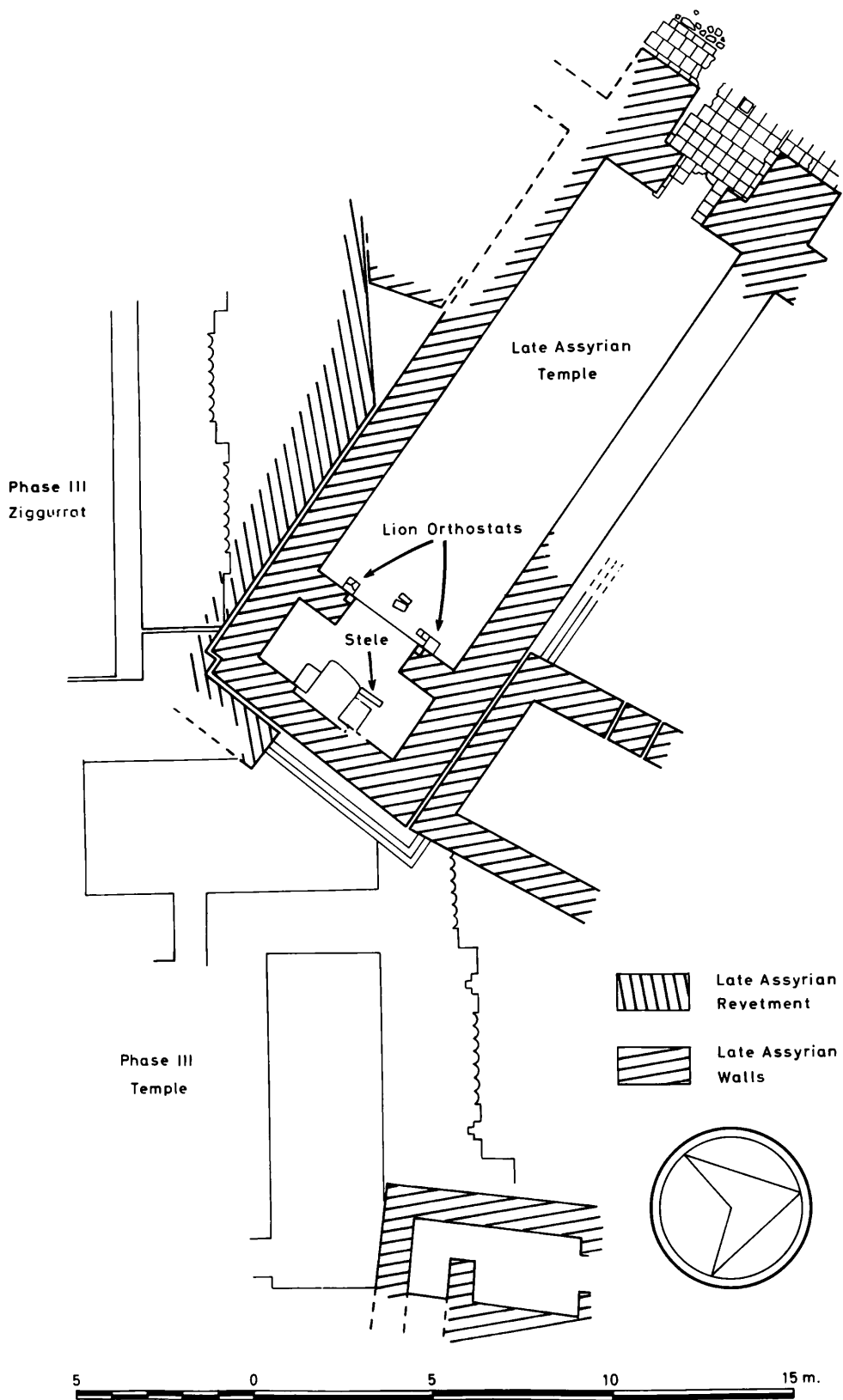

Figure 15. Site A Plan of the Late Assyrian Temple

Site D

- Level 1 = Early Islamic**
- Level 2 = Late Assyrian**
- Level 3 = Middle Assyrian**
- Level 4 = Mitanni**

Site D was excavated on a grid pattern, so that no building was completely exposed, but neither the character of the buildings nor their contents seemed to justify the expense of extensive excavation, especially since the sequence appeared simply to reproduce that better attested on Site C. Our decision to excavate in this particular area was influenced by the apparent regularity of its plan. It was a high mound, superficially rectangular, and we hoped that it might contain some monumental building attached to the city wall. Its superficial appearance proved deceptive, for the rectangle was merely the courtyard of a building, perhaps a farm-house, of medieval Islamic date (pottery batches D11, D96). Below this level the wall alignments changed to an axis that was obviously dictated by the presence of the town wall. Occupation here included a considerable Late Assyrian phase (D Level 2), and beneath it a sequence corresponding with Site A Levels 1 and 2 (D Levels 3-4). Over most of the area of excavation work ceased at Level 4, that corresponding with Site A Level 2 and C Level 5; in the lower part of the trench towards the town we exposed some earlier structures that must be assigned to the Old Babylonian period, but these were not further excavated.

An interesting feature of the Late Assyrian levels was the presence of a number of graves, for the most part associated with the houses (cf Plate 17). As on Site C, the grave goods were in general meagre, consisting at most of a pottery or bronze bowl and a few simple ornaments of copper/bronze or faience (see below, pp. 45-47). The most substantial building phase lay in Level 4, but finds were few, probably reflecting a peaceful period of occupation rather than poverty. Among them were sherds of Nuzi ware and a pig pot inscribed with an indecipherable cuneiform sign (pot 1189). An interesting feature of Site D Level 4 was the evidence that the town wall was not maintained, either because it was no longer needed or because the necessary resources and authority were no longer available. Indeed by the Mitanni period the accumulation of debris against the inner earth bank at the foot of the wall had reached its flat upper surface, so that the surviving bank served as a terrace with houses sloping gently away from it towards the low-lying ground within the town.

Site D Level 1 is to be dated to the 13th or 14th century AD.

TELL AL RIMAH

Stratigraphic Summary

Historical Period	Site A	Site C	Site D	AS
Late Assyrian	LA	Level 1	Level 2	–
Middle Assyrian	Level 1	Levels 4-2	Level 3	–
Mitanni	Level 2	Level 5	Level 4	–
Late Old Babylonian	Level 3	Level 6a	unexcavated	–
Old Babylonian:				
Hammurapi	Level 3	Level 6	–	–
Shamshi-Adad	Level 4	Level 7	–	–
early 2nd mill.	Level 4	–	–	Phase 3 = A4
Late third millennium	unexcavated	–	–	Phase 2 = A5
	–	–	–	Phase 1 = A5

The Graves (Plates 16-18)

The earliest graves found on the site date to the late third millennium (3 graves, Area AS). Only one contained pottery (AG 3-68, pot 547, cf Plate 4b). The body is extended, knees flexed, head to the west. No Old Babylonian graves were found, but a small number are attributed to the Mitanni period. Of these by far the most important is the multiple burial tomb discovered on Site D (DG 22-66, Plate 16). It was lined and originally vaulted with mud-brick and floored with gypsum plaster. It had obviously been re-used on a number of occasions and at least five individuals had been buried in the chamber. To make room for each new interment the earlier skeletons had been piled at the far, southeast end. The grave goods are unusually rich and included a glass bottle (TR 3616, see *Iraq* 29, 1967, Pl. 37e), two Mitanni cylinder seals (one glass and one frit), a gold disc, bronze jewellery, two bronze bowls and a quantity of beads of frit, glass, crystal, red porphyry, marble, carnelian and Indian Ocean shells. Only two other adult Mitanni graves were found. CG 17-68 contained a plain footed beaker (751) and a bowl (74); CG 7-71 had mud-brick on edge above it and contained a contracted adult, head to the west, with two ivory needles. Six Mitanni child burials were recovered; DG 10-66, a foetus buried in a large, plain footed beaker (639); CG 3-71, a child burial in pot 994, with three glass and frit beads; CG 11-71, a child buried in a rimless large jar together with plain beaker 741; CG 15-71, a child burial in jar 1008. CG 17-71, a child burial in jar 1019 was rather more richly provided, with 44 glass beads, a copper/bronze bracelet around the radius and ulna of the skeleton and an anklet around the tibia and fibula.

Middle Assyrian graves were uncommon in the areas excavated but included another child burial, CG 2-71, in jar 983; grave goods consisted of a copper/bronze earring, two lapis and two glass beads, the lapis examples found one below each ear. Cloth impressions were also present within the jar, and the broken top was closed with a rimless deep bowl. An adult Middle Assyrian grave from Site D (DG 2-66) contained 96 cowrie and 31 faience beads.

By far the largest number of graves were those of the Late Assyrian period. This includes 21 of the 24 graves excavated on Site D (1966), 15 of the 17 1968 Site C graves and 10 of the 17 Site C graves excavated in 1971. Many of the Late Assyrian graves appear to have been directly associated with the houses, but a small number had been dug from the immediately underlying level and must therefore fall early within the Late Assyrian reoccupation of Rimah, i.e. sometime in the 9th or early 8th century. Pottery from the latter graves includes bowl 88, found near the head of an extended adult, head to the east (CG 4-71); jar 951 which lay near the feet of adult burial CG 5-71; and beaker 670, found by the left elbow of adult male CG 10-71, buried slightly contracted with head to the northeast and wearing a copper/bronze finger ring on the left hand. Although a few Late Assyrian graves appeared to have no grave goods (*inter alia*, CG 13-71, CG 14-71), some contained a number of pieces of jewellery, in particular copper/bronze anklets, armllets and rings. A variety of stone beads were common, including carnelian, red porphyry and marble. The overall impression is of a prosperous Late Assyrian community, though at least among the graves there is no sign of exaggerated wealth. As in the case of the earlier second millennium graves, the bodies lie extended with the head to the east or northeast, an apparent contrast with the two third millennium burials (Plate 4b). Bowls and cups tended to be placed near the head of the skeleton; jars 949-51 all lay at the feet. Small children were interred in jars, while the adult graves were of different types, some simple pits, others lined with mud-brick and capped with bricks set on edge, horizontally, or balanced against each other in gable fashion. In others the burial was covered by the two halves of a storage jar. In DG 7-66 cup 945 lay by the mouth, while 35 cowrie and one glass bead were found just above the head as though they had formed some kind of tiara or headdress (Plate 17e). In DG 17-66 the extended body was accompanied by 132 carnelian and 3 blue faience beads, a silver earring and finger ring, a bronze bracelet with animal head (?lion) terminals, a bronze bowl, and a bone necklace on which fragments of reddish-purple ribbed cloth survived. Of interest also is the triple pot burial (jars 601-3), from which the adult male's feet extended beyond the last of the three pots (CG 5-68, Plate 18). Grave goods included a cylinder seal, a copper/bronze bowl and the articulated bones of most of the body of a young sheep or goat. A double burial was recovered (CG 4-68), while one grave appeared to contain infant bones lying above the adult's head (CG 14-68). Child burials included DG 5-66, a fragmentary skeleton of a baby buried in two pots, of which 980 provided the only complete profile. Unusual is the group of three pot burials (DG 8a/c-66) (Plate 17a-c). The uppermost (DG 8a-66) (a) contained 98 black and white frit beads, while the infant burial (DG 13-66) illustrated on Plate 17d wore three copper/bronze armllets terminating in snakes' heads, two on the right arm and one on the left. Other child burials were found in jars 982 (CG 10-68) and 984 (CG 11-68); a child in a double pot burial (CG 8-68) (cf bowl 492) wore a pair of crescent-shaped copper/bronze earrings.

Graves containing grave goods

1966 Site D Graves

Grave	Level	Contents	TR No	Pot No	Plate No
DG 2-66	MA	faience ring copper/bronze finger ring 97 cowrie shell beads 31 faience beads bowl	3720 3509 3802 3727	36	Plate 30
DG 3-66	LA	adult, knees flexed jar at feet	3119	949	Plate 17f Plate 82
DG 4-66	LA	child burial in two jars pair of copper/bronze anklets	3504		
DG 5-66	LA	fragmentary skeleton of baby in two pots only one complete jar profile		980	Plate 85
DG 6-66	LA	Copper/bronze finger ring	3508		
DG 7-66	LA	adult, extended cup at mouth 35 cowrie beads above head faience bead above head	3112 3803 3727	945	Plate 17e Plate 81
DG 8a-66	LA	child pot burial jar 98 black and white frit beads	3712	979	Plate 17b Plate 85
DG 8b-66	LA	child pot burial, no grave goods jar		977	Plate 17c Plate 85
DG 8c-66	LA	child pot burial, no grave goods All three burial pots illustrated in Plate 17a			Plate 17a
DG 10-66	Mitanni	foetus burial contained in large footed beaker	3113	639	Plate 66
DG 12-66	LA	adult shallow copper/bronze bowl in hands	3511		
DG 13-66	LA	infant pot burial deep bowl 3 copper/bronze bracelets terminating in snake's head, 2 on right arm, 1 on left arm	3506	598	Plate 17d Plate 63
DG 16-66	LA	adult cup	3104	848	Plate 77

1966 Site D Graves continued

Grave	Level	Contents	TR No	Pot No	Plate No
DG 17-66	LA	adult			
		132 carnelian beads	3401		
		6 blue faience beads	3726		
		pair silver earrings and finger ring	3503		
		copper/bronze bracelet with lion-head terminals	3507		
		shallow copper/bronze bowl	3510		
		bone necklace	3811		
		fragments of reddish-purple cloth			
DG 18-66	LA	child, extended			
		2 silver rings	3502		
		3 carnelian beads	3400		
DG 19-66	LA	adult, extended, in coffin			
		2 carnelian beads, 1 red porphyry bead	3401		
DG 20-66	LA	adult, crouched, in brick-lined grave			
		pair of copper/bronze anklets on ankles	3505		
		3 carnelian beads	3400		
		24 faience beads	3726		
DG 22-66	Mitanni	tomb with at least 5 bodies			Plate 16
		bowl	3101	86	Plate 32
		bowl	3100	89	Plate 32
		bowl	3102	90	Plate 32
		bowl	3103	137	Plate 35
		jar		1001	Plate 87
		glass bottle	3616		
		gold disc	3501		
		copper/bronze bowl	3512		
		copper/bronze bowl	3513		
		glass cylinder seal	3614		
		frit cylinder seal	3730		
		copper/bronze pin and ring	3508		
		106 stone beads including carnelian, crystal, agate	3400		
		4 glass beads	3603		
		12 glass beads	3606		
		3 glass beads	3612		
		4 bonnet shell beads	3802		
		other beads including 19 marble, 1 red porphyry			
		Ref. <i>Iraq</i> 29, 1967, 93.			

1968 Site A Graves

Grave	Level	Contents	TR No	Pot No	Plate No
AG 1-68	3rd mill.	adult, no grave pit lapis bead bronze pin	5230a 5310		Plate 4b

AG 3-68	3rd mill.	extended adult, legs flexed, no grave pit bowl in front of face carnelian bead, shell bead	5026 5616b	547	Plate 4b Plate 59
---------	-----------	--	---------------	-----	----------------------

1968 Site C Graves

Grave	Level	Contents	TR No	Pot No	Plate No
CG 2-68	LA	adult, extended with miniature bowl		476	Plate 55
CG 4-68	LA	double adult burial, upper skeleton slightly crouched copper/bronze ring, probably on right hand	5303		
CG 5-68	LA	triple pot burial, adult male, feet extend beyond last pot deep bowl deep bowl deep bowl copper/bronze bowl held on chest cylinder seal glass bead most of body and hind legs of young sheep/goat		601 602 603	Plate 18 Plate 63 Plate 63 Plate 63
CG 8-68	LA	child, body in jar, head at base bowl over top pair of crescent-shaped copper/bronze earrings		492 5319	Plate 56
CG 9-68	LA	fragmentary foetal bones in small unbaked clay jar bowl inverted over top glass bead and copper/bronze fragment	5005	~495	Plate 56
CG 10-68	LA	child jar burial, head at neck of jar		982	Plate 85
CG 11-68	LA	child jar burial, head at neck of jar		984	Plate 85
CG 13-68	LA	extended adult lying face-down over fallen vault jar at feet	5025	950	Plate 82
CG 14-68	LA	adult lying on back with infant bones (?) above head copper/bronze bowl held on stomach	5379		
CG 17-68	Mitanni	adult bowl containing some finger bones held in hand beaker found beside head	5053 5052	74 751	Plate 32 Plate 72

1971 Site C Graves

Grave	Level	Contents	TR No	Pot No	Plate No
CG 1-71	LA?	adult glass bead	6232		
CG 2-71	MA	child pot burial jar copper/bronze earring 2 lapis (found one below each ear) and 2 glass beads	6402 6228-30	983	Plate 85
CG 3-71	Mitanni	child pot burial jar 2 glass beads 1 frit bead	6226 6227	994	Plate 86
CG 4-71	early LA	extended adult, bowl found near head	6005	88	Plate 32
CG 5-71	early LA	adult, jar near feet	6002	951	Plate 82
CG 7-71	early Mitanni	adult, contracted, mud-brick on edge above burial 2 ivory needles	6503, 6506		
CG 8-71	early LA	adult copper/bronze nose-ring and finger ring carnelian bead	6412 6241		
CG 10-71	early LA	adult, slightly contracted beaker by left elbow finger ring on left hand	6003 6411	670	Plate 67
CG 11-71	Mitanni	child jar burial 3 carnelian, 2 blue and 1 white frit beads	6004 6245-48	741	Plate 72
CG 12-71	early LA	adult straight-sided copper/bronze bowl 26 cowrie shells found behind the skull (?tiara or necklace)	5431 6544		
CG 15-71	early Mitanni	child pot burial, upper part of jar removed to admit burial		1008	Plate 87
CG 16-71	early Mitanni	child pot burial, lower part of jar removed to admit burial stone bead	6265	1016	Plate 88
CG 17-71	early Mitanni	child pot burial 46 glass beads copper/bronze bracelet around radius and ulna copper/bronze anklet around tibia and fibula	6068 6272-73 6433 6434	1019	Plate 88

CHAPTER 2

The Pottery

The pottery published here provides by far the best second millennium sequence now available for Northern Mesopotamia. For this reason we have deliberately focused on the Rimah evidence, in general without recourse to parallels elsewhere, at least some of which may now be more accurately dated on the basis of the information from Rimah. This is not to claim that the Rimah sequence is in any sense “complete”: only that parts of it are unusually well-dated on epigraphic evidence. No archaeological sequence is ever “complete” in the sense of preserving for us the full range of non-perishable material culture originally associated with the occupation of a site. The only well-stratified, *in situ* objects that survive on any Near Eastern tell site are those that happened to be in use at the time the site, or the building, was destroyed. Peaceful times were no doubt preferred by the inhabitants but to the archaeologist, except for the soil micromorphologist, they provide little of material value, at least in societies that regularly swept clean their floors. Moreover, the stratigraphy of tell sites is compromised, often severely, by the secondary or even tertiary deposition of rubbish as levelling fill or raw material for mud plaster or brick, while monumental building operations frequently involved the deliberate removal of immediately preceding archaeological strata. The latter is not a significant problem on Site A at Rimah, since it was in any case impossible to excavate below the Great Temple. But little remains, for example, of Shamshi-Adad’s palace, overlain as it was by the massive “shining palace” of the succeeding local dynasty.

Context also has a limiting effect on the types of pottery and other objects that survive. Buildings are rarely excavated *in toto*, and room function largely dictates the distribution of ceramic types, an effect particularly noticeable at Rimah between Sites A and C (see Figures 16-48). Differences from one archaeological site to another will be greater still, since destruction levels are unlikely consistently to coincide, and there is always a degree of local stylistic variation. The meaning of style is not our purpose, except in a gross historical sense; a major objective at Rimah was to provide not only general historical and social information for at least one second millennium town, in a period little known in Northern Mesopotamia at the time the excavations began, but to fill a very specific gap in our archaeological knowledge of the area in providing as well-dated a sequence of pottery and other materials as possible. The discovery of cuneiform archives has given us not only invaluable historical information but also both fixed points in time for specific groups of *in situ* pottery and well-dated chronological limits to the distribution of others. Of especial importance here are the seal impressions dating the earliest Area C Palace (C7) to the time of Shamshi-Adad (pot batches C459, C476, C561), and the letters of Hatnu-rapi (C42, C46, C442), the archive of the lady Iltani (C78) and the so-called wine tablets (C395) which date the material from the Phase 6 Palace to the time of Zimri-Lim and Hammurapi. The latest occupation of the Great Temple is clearly dated by *limū* of Shalmaneser I and Tukulti-Ninurta I, i.e. coming to an end sometime around 1200 BC. The Late Assyrian resettlement of the site is possibly dated by the Nergal-Eresh stele (Plate 15), erected in the name of Adad-Nerari III (810-783). The associated late 9th/early 8th century pottery, both in the shrine and on Sites B and C, provides an important addition to the late 7th century BC Nimrud repertoire published in *Iraq* 1959.

The pottery plates illustrating this volume are organised essentially by shape and function. Specific comment on these plates is provided in the notes (Chapter 3). A complete list of the published pottery from each batch can be found on pp. 255-267. The “catalogued” pottery consists of relatively complete or unique vessels submitted to the Directorate-General of Antiquities in Baghdad for official “division”, in which some were allocated to the Expedition; the catalogued pots published in this volume are listed on pp. 269-275. Column graphs are provided to illustrate the distribution of various pottery types (Chapter 3, Figures 16-48); in interpreting these, however, the reader must remember that even large sherds, in large numbers, can be contained in out-of-context levelling fills. For this reason,

emphasis in the text is placed on *in situ* groups of relatively complete vessels. Normally only complete profiles are illustrated; the type range, indicated in the charts accompanying the plates, incorporates data from the sherd records.

The second millennium in Northern Mesopotamia is characterised by two very distinctive types of pottery, the so-called Khabur and Nuzi wares. Both terms have been used by some authorities to identify ethnicity (Hurrians) or political entity (Old Assyrian, Mitanni) as well as to establish chronology and social status. Their distribution at Rimah, and the use of these labels, is considered in the following sections.

a) Khabur ware (Plates 19, 58, 74, 75, 78, 79, 90 etc)

Although very distinctive second millennium painted pottery had long been known, for example at Billah and Tell Halaf, the term Khabur ware originated with Mallowan's excavation of Chagar Bazar (1937, 103) and the discovery not only there but also on many nearby sites of a very easily recognised monochrome painted buff fabric, often but not always chaff-tempered, commonly decorated with simple parallel bands or hatched or cross-hatched triangles, often on the shoulders of jars. Khabur ware shapes comprise a variety of jars, including those from Chagar Bazar referred to by Mallowan as "wine jars" because they often contained copper wine strainers (note that their Chagar Bazar context is for the most part from burials, Mallowan 1937, Fig.21 and 22:14). Many of the Rimah "wine jars" (Plate 90) were found with the wine and beer "archive" (*OBTR* tablets 250-71), which detailed the issue of wine and beer rations and with which these vessels had been discarded (batch C395). At Chagar Bazar other Old Babylonian Khabur ware types include the very distinctive bowls with sets of parallel painted bands across the rim (Rimah 517-519). This type of decoration is found also on jars (560) and at Rimah spans the period from Shamshi-Adad or slightly earlier (520, 521) to the end of the Old Babylonian period (519 is from the Late Old Babylonian kitchen). Other early painted types include pottery made of a fine cream fabric previously assumed to be an attribute of Late Old Babylonian date. This includes a very fine, thin-walled, cream-coloured bowl, of shape similar to 521 and from the same context, decorated on the rim with pendant triangles between two horizontal bands in an underfired, very thick dark red pigment; a similar fabric and paint occur on a fragment of a ribbed beaker found with the tablets in Room II of the Temple (batch 565) but probably of earlier date. The latter displays one of the most common features of Old Babylonian Khabur ware, the presence of paint splash on the interior (see, *inter alia*, 517-18, 790, 793-99, 870). At first glance this would seem to reflect an uncharacteristically careless use of the brush, but paint splash is found consistently on otherwise very carefully painted vessels, and on very specific types, suggesting that it was done deliberately. Whether this was a workshop signature, or thought to be aesthetically pleasing, we cannot know. But it is certainly a very recognisable characteristic of specific types of Old Babylonian and Mitanni Khabur ware.

The combination of Khabur paint with a protruding ribbed band on the upper shoulder is one of the most easily recognised early Khabur ware types (Mallowan 1937, Fig. 22:11, *Brak* I, vessels 293-302). The same very distinctive ribbed band occurs also on otherwise undecorated small cups and bowls (879-881; *Brak* I, 291-92). Other types of monochrome painted vessels were also included by Mallowan under his Khabur ware umbrella. Among these are shoulder beakers (*inter alia* Mallowan 1937, Fig. 24:11, 14, the latter, unusually, decorated with cross-hatched triangles as are many Khabur ware jars). The evidence from Rimah considerably expands our knowledge of beaker development, providing for the first time a well-stratified sequence which demonstrates clearly that most beakers of the time of Hammurapi and Zimri-Lim remained undecorated (*inter alia* 754, 759-63, 768, 770), whereas by the time of the Late Old Babylonian kitchen, parallel bands of red paint had become the fashion (Plates 74-75). Many of the latter beakers, and in particular the banded beakers (797-801, 832), which are exclusively Late Old Babylonian and Early Mitanni in date, bear the interior paint splashes so characteristic of Old Babylonian Khabur ware (and of course of the workshops in which it was made).

Khabur ware is now known from the Zagros in the east (Dinkha Tepe) to Alalakh in the west. It is most frequent in Northern Iraq and in the Khabur Triangle in northeastern Syria; it is uncommon along the Khabur River itself and westwards. On the evidence from Tell al Rimah, the earliest date for the use of Khabur ware cannot be established beyond the observation that it is found in pre-Temple contexts and may therefore predate the time of Shamshi-Adad. At Chagar Bazar the earliest Khabur ware was actually associated with tablets of the time of Shamshi-Adad; indeed some tablets "rested on sherds of coarse Khabur ware painted with red stripes" (Mallowan 1937, 82), perhaps from their original containers. On

the evidence from Brak Khabur ware cannot be earlier than c. 1950 BC, and we believe that its earliest exemplars are more likely to date from the 19th century. The relevant sample is very inadequate, but it would appear that a combination of combed or grooved and painted ornament is characteristic of this earliest phase (pots 520, 521, 621); certainly this type is not found after the time of Shamshi-Adad. At Rimah Khabur ware of this time is easily recognised from the occurrence of very thick, underfired paint (Munsell colours 10R “dusky red”; 5YR 3/2 “dark reddish brown”) and the use of deep grooving within the painted ornament on jar shoulders (pots 558, 559, 875); hatched or cross-hatched triangles in combination with intervening large solid dots (Plate 19) would also seem to be an early feature.

An early study by Hrouda (1957) identified an “older” and a “younger” Khabur ware, the latter contemporary with the use of Nuzi ware but retaining many of the decorative principles of the Old Babylonian form. Indeed at Brak even the paint splash, often considered exclusively an Old Babylonian trait, is found on a number of specifically Mitanni vessel types (*inter alia*, Brak I: 455-457; see also the Mitanni banded beakers from Rimah, e.g. 799). This clearly implies a persistence of workshop tradition, presumably reflecting the essential continuity of local populations in the face of dynastic change. More recently, some have viewed these stylistic differences as regional rather than chronological, dating all Khabur ware to the period 1900-1600 BC (*inter alia*, Kramer 1977, 94, but qualified in n. 63). Indeed, despite a number of perceptive studies in which the chronological persistence of Khabur ware has been noted, it remains in the view of many archaeologists a type fossil specifically of Old Babylonian (Middle Bronze) date. The evidence published in this volume and, perhaps even more convincingly, that published in *Brak I* illustrates clearly the degree to which the use of red-striped decoration is characteristic of Mitanni as well as Old Babylonian tradition, and the fact that in early Mitanni levels this type of decoration is not confined simply to beakers or goblets.

Another persistent view has been that animal or bird decoration was rare or non-existent in the Old Babylonian period, and that the use of bird ornament in particular was characteristic of the “younger” Khabur ware and its contemporary Nuzi ware. The Rimah evidence proves beyond any reasonable doubt that bird ornament is a feature, if an uncommon one, of Late Old Babylonian pottery. Indeed the beaker sherd from batch C78, illustrated on Plate 19e, upper right, was found with the tablets of the Iltani archive in the Site C Level 6 Palace. One might suspect its intrusion in one of the many pits dug into the Palace in the Late Old Babylonian period, but beaker 1059 is of similar date, from the contemporary Temple Level 3 destruction floor. No complete bird-ornamented vessels of early Old Babylonian date have as yet been found, but further sherds from beakers decorated with rows of running birds are attested from the overlying Late Old Babylonian strata (818, 826 – also illustrated on Plate 19e, 827, 828, 878 and an unpublished example from Site C batch 85). The surviving examples perhaps suggest a stylistic difference between the low running crouch of Late Old Babylonian and early Mitanni birds (1057, 1058, 1059) and the more upright, and more common, later Mitanni variety (863, 1055). The large chaff-tempered sherd illustrated on Plate 19e, upper left, is not securely stratified, but is likely also to be of Late Old Babylonian date; it is from a large open bowl or basin to judge from the paint dribbles on the interior. The pattern of leonine animal and checkerboard, Plate 19a, a sherd which comes from outside the south gate of the Temple and is therefore not securely stratified, provides the sole possible Late Old Babylonian example from Tell al Rimah of the use of animal ornament on Khabur ware.

Perhaps more important is the distinction between chaff- and mineral-tempered fabrics, often assumed to differentiate the “older” and “younger” varieties of Khabur ware (see extensive discussion in Pfälzner 1995). The evidence from Rimah suggests, however, that such differences in fabric are as much a variable of vessel size and function as of chronology (cf wares illustrated on Plates 73-76, 78, 79). For example, the majority of the “wine jars” of Plate 90 do not show the use of chaff; these date from the time of Zimri-Lim and provide an interesting contrast in style with the single example from the time of Shamshi-Adad (1052, mineral temper) and in both style and fabric with the earliest large Khabur ware jar recovered at Rimah (1064, mineral and chaff). Such observations of course reflect very minimal evidence, and it would be reasonable to argue that the differences not only of ware but also of style are functional as well as chronological. But in general chaff temper is uncommon in the Site C Palace Level 6 Khabur ware, i.e. that of the time of Hammurapi, whereas that from the earlier contexts C7 and A4 shows its greater but certainly not exclusive use.

Most archaeological chronologies depend on the fact that style changes over time and certainly, as Hrouda suggested long ago, there are very recognisable early and late Khabur types, but the Rimah pottery demonstrates clearly that coarse buff chaff fabrics ornamented with simple monochrome bands of paint are to be found in both Old Babylonian and Mitanni, and even Middle and Late Assyrian (pot 505), contexts. Indeed the assumption that such coarse sherds are of necessity Old Babylonian has

almost certainly led to over-identification of Middle Bronze/Old Babylonian sites and under-representation of Late Bronze/Mitanni on site surveys in Northern Mesopotamia (*inter alia* Ball *et al.* 1989, 18, 34; Meijer 1986, Fig. 10). The evidence from Brak not only supports this view but also tells us that by the end of the Mitanni domination there (late 14th century) the “younger” Khabur ware was no longer being made.

In this volume we have deliberately chosen to avoid at least some of the problems of stylistic chronology by using “historical” terminology, a solution well-justified by the number and historical content of cuneiform texts found at the site. However, the evidence from both Rimah and Brak shows that, although there are some specific Mitanni types, such as Nuzi ware and red-edged bowls, in general the “interface” between Old Babylonian and Mitanni cannot be clearly distinguished on the basis of pottery alone, that is, there is no clear typological break between the two. At Rimah this is strikingly illustrated by the pottery from the so-called kitchen on Site C where there occur a variety of types that bracket the Late Old Babylonian and early Mitanni periods: banded beakers, shallow rough-based bowls, grey burnished wares, etc. As for Khabur ware itself, there are many views (most recently summarised in Pfälzner 1995). For reasons outlined above, we take an essentially pragmatic approach: “Khabur ware” describes no more than a style of monochrome painted pottery, the use of which does not coincide with any single political entity. The fabric itself varies as much according to vessel type as to date. Thus, in our view, there is no justification for limiting the use of the term to the Old Babylonian period, a practice which can prove seriously misleading. It is also our view that the compelling evidence for the internal development and coherence of Khabur ware has been obscured in a search for “origins”, in particular of the striking range of drinking vessels that characterise all second millennium pottery. Despite his more recent revisions (1975, 1989), Hrouda’s “older” and “younger” Khabur ware groups remain in a general sense viable and useful concepts.

b) Nuzi ware (Plates 21-23; Figure 35)

“Nuzi ware” presents similar though far less complex problems. Again a term introduced by Mallowan (1946), in this case to avoid the ethno-linguistic and geographical implications of the labels then in use (“Hurrian” and “Subartu”), “Nuzi ware” describes very specifically a type of monochrome decorated pottery (in this sense comparable with Khabur ware with which it shares many vessel forms), but on which patterns are drawn, unusually, in white paint. Such pottery occurs throughout the period of Mitanni control, from the Amuq plain in the west to northeastern Iraq. Like Khabur ware it is not a southern Babylonian type, although sherds have been found there, for example at Aqar Quf (Baqir 1945, Fig. 26). As in the case of Khabur ware, temper is largely a factor of vessel size and function. The most distinctive Nuzi ware type is the footed beaker, which first appears in early Mitanni levels at both Brak and Rimah. It has been suggested that this is a form derived from glass prototypes, but existing evidence does not sustain such a view (the earliest footed glass beaker from Rimah, one of the few well-dated examples, was found in a context clearly attributed to the end of the Mitanni period there (*Iraq* 30, 1968, 134), though this of course does not provide a date for its manufacture.

In her very useful study of Khabur and Nuzi ware Stein (1984, 23) extends the term to encompass Nuzi ware vessel shapes whether the white overpaint is present or not, a view now apparently endorsed by Hrouda (1989). In our opinion this compounds confusion, especially since Old Babylonian vessel shapes, for example the shoulder beaker, are manufactured in Nuzi ware. We strongly recommend that the term be retained in its conventional usage, exclusively for the white-painted examples. These do not occur in large quantity on any site and have been considered vessels signifying the status of the owner, a luxury commodity possibly even contingent upon court patronage. A range of new evidence, in particular from “rescue” excavations in the Khabur region, suggests the distribution of this “elite” product within private dwellings as well as the residences of more affluent members of society. Nonetheless, it is true to say that Nuzi ware remains uncommon in household contexts. The intensive French survey in the region of Qamishli recovered only three Nuzi ware sherds in over a tonne of surface pottery (Lyonnet 1992, 107), on the Hawa survey not a single sherd was recovered except at the urban site of Hawa itself (Ball *et al.* 1989, 18), while only ten sherds are published from the excavation of the large village site of Tell Bderi (Pfälzner 1995, Pl. 66). The evidence from Brak demonstrates, moreover, that the earliest Nuzi ware includes a variety of jars, “grain measures” (cf Rimah 699), ring-based bowls, shoulder beakers, tripod vessels, etc. That is, early Nuzi ware is not specifically characterised by the so-called standard range of drinking vessels which become predominant in later Mitanni usage. The

chronology and distribution of Nuzi ware suggest a significant correlation with the zenith of Mitanni control, and in this case there would have been equal justification in a term such as “Mitanni ware”; but “Nuzi ware” is well-established and easily recognised, and we believe, despite the fact that Nuzi itself lies close to the eastern limit of its distribution, that the term should continue in its conventional, and convenient, use.

Accident of archaeological discovery has led to the view that western Nuzi ware (Alalakh) is characterised by an emphasis on floral motifs, attributed to Aegean influence, by contrast with an emphasis on geometric patterns at Brak and further east. Although it remains true to say that geometric patterns predominate, evidence particularly from Brak but also from Rimah reveals an extensive repertoire of floral patterns (*inter alia* bowl 680, Plates 23, 71), including some closely paralleling Alalakh examples (e.g. beaker 718 and Woolley 1955, Pl. CIIa). Moreover, Hrouda’s assertion, though justified at the time, that there are no two sites where Nuzi ware is conceived in exactly the same way (1957, 13-16) is now contradicted by the evidence from Brak and Rimah, some 140 km apart, from which this pottery is in large part indistinguishable. Nuzi ware is found as late as the 13th century at Rimah (bowl 680), Kar-Tukulti-Ninurta (Andrae 1925, Pl. 5) and Emar (Margueron 1975, Fig. 6). Its earliest occurrence at both Brak and Rimah would seem to coincide with the beginnings of Mitanni suzerainty. At Rimah two sherds appear to come from slightly earlier contexts, but neither is securely stratified: sherd 695 from a pit dug into Level 6 and an unpublished example from outside the east gate (A398).

c) Old Babylonian pottery

Despite the difficulties we have outlined with the use of the term, the most easily recognised component of the Old Babylonian repertoire is of course Khabur ware. As noted above, however, much “conventional” Khabur ware is of Late Old Babylonian or early Mitanni date. Early Khabur ware is often decorated with combinations of both painted and combed ornament, and certain other specific pottery types can be dated to the late 19th and early 18th centuries. These include very distinctive vessels with a single band of fine ribbing (879-81, Plate 19d). Similar ribbing occurs on larger Khabur ware bowls and basins. Other Old Babylonian Khabur ware types are discussed on pp. 52-54. Another easily recognised type, of southern origin and rare at Rimah, is the grey ware with white inlay of Isin-Larsa date, which must be distinguished from the Mitanni variety of inlaid impressed ware discussed below. Grey wares in general occur widely in Old Babylonian and Mitanni contexts (Plates 41, 44-46, Figure 45). Coarse shallow bowls with a rough exterior surface constitute a very distinctive and very common Old Babylonian type, found to a lesser degree in early Mitanni levels (Plates 47-50); surprisingly, up to now only one example of this type has been recovered at Brak, though this may possibly be a matter of function and reflect no more than the very limited area of excavation in Old Babylonian levels at the latter site.

Extremely fine, undecorated, elongated beakers are characteristic of early Old Babylonian levels and occur together with shoulder beakers, also undecorated (Plate 73); in Late Old Babylonian and Mitanni levels the latter are usually ornamented with horizontal bands of red paint. The Late Old Babylonian “kitchen”, Site C, provides the largest contemporary collection of these red-striped beakers (Plates 74, 75). Interestingly, the large jars from the kitchen remain unpainted (1011, 1021, 1022, 1025, 1028-31) though a number of large urns bear wavy incised decoration (624, 630-32), a style also characteristic of early Mitanni contexts (623). The percentage of decorated as opposed to plain beakers recovered from the kitchen (Plate 75 etc) far exceeds that of the time of Hammurapi and Zimri-Lim when most beakers remained undecorated. A similar shift is visible at Chagar Bazar and in the Site A Late Level 3 beakers from Rimah. Figure 36 illustrates the overall distribution of shoulder beakers decorated with other types of pattern (as on Plate 76); indeed there would seem to have been greater variation in the ornament of bowls and beakers in the Old Babylonian period than in later times (*inter alia* 512, 823, 824, 832, 837, 840). A striking example of the stylistic overlap between “Old Babylonian” and “Mitanni” is the very distinctive beaker with wide rib (797-801, 840) found exclusively in Late Old Babylonian and early Mitanni contexts. Such “overlaps”, of course, reflect the fact that local people retain their tastes and potters their habits despite changes in political suzerainty.

Certain contexts have provided large collections of pottery in association with well-dated Old Babylonian tablets. These include various rooms in the Site C Palace, the lady Iltani’s bathroom (room VI, batch C78); room II in which the letters of Hatnu-rapi were found (batches C42, 46, 442) and the

pottery associated with the so-called wine and beer tablets (C395, 440, 444), all of the time of Hammurapi. A small collection of pottery from below the Level 6 Palace clearly dates from the time of Shamshi-Adad (batches C459, 476, 561, 813). One of the largest pottery deposits came from the destruction level in Room II of the Old Babylonian Temple (A565, Plate 3a), also associated with cuneiform tablets and probably contemporary with the destruction of the Site C Level 6 Palace, but less precisely dated. We believe the overlying, later Level 3 floors, noted as “late 3” in the batch lists (see *inter alia* batch A463 and Plate 2c), to be approximately contemporary with the Site C Level 6a Late Old Babylonian kitchen. Both are followed by the major rebuilding which we associate with the beginning of Mitanni influence at the site.

d) Mitanni pottery

The term Mitanni is used on the historically reasonable assumption that the destruction and rebuilding of the Great Temple at the end of the Old Babylonian period signals the presence of Mitanni power at Rimah; unfortunately this assumption cannot be corroborated by epigraphic evidence beyond the presence of Hurrian names, found also on the Old Babylonian tablets (15% of Iltani’s archive, 42% of the Temple tablet names, S. Dalley, pers. comm.). This “Mitanni” domination of the site is represented in Level 2 in the Great Temple and Level 5 on Site C and is certainly contemporary with the period during which Mitanni power extended over most of northern Mesopotamia, at least as far as Nuzi and the Rania plain. We have already noted that the material from the Late Old Babylonian kitchen (level 6a, Site C, batch C686 and related numbers), especially the variety of beakers decorated with horizontal painted stripes and the use of running bird ornament, in many ways anticipates the stylistic developments seen elsewhere in Mitanni contexts and well-represented at Rimah in Site C Level 5. Exclusively Mitanni types do exist, however, of which the most distinctive is of course Nuzi ware, not found at Rimah in secure contexts before Site A Level 2c and Site C Level 5b. Piecrust potstands (Plate 93) and red-rimmed bowls (Plate 34) are among the most characteristic and recognisable Mitanni types. Among the more amusing are the “pig pots” (Plates 20d, 99). Also signifying Mitanni influence are the straight-sided beakers (Plate 67); footed examples are essentially Mitanni in date, whereas nipple-based beakers are characteristically Middle Assyrian (one of several exceptions is Plate 20a). At Rimah both the red-edged bowls and, to a lesser extent, the very distinctive pie-crust potstands persist into Middle Assyrian levels. In making comparisons with other sites, however, it must be remembered that the designation “Middle Assyrian” reflects political control and therefore varies in date according to the political history of the site. Thus 14th century material is correctly classified as Mitanni at Brak and Middle Assyrian at Rimah.

The occasional use of animal and bird motifs is often claimed to be characteristic of the “younger”, i.e. Mitanni, Khabur ware. Certainly the bird vessels of Rimah, and even more commonly at Brak, provide an easily recognisable type fossil for the Mitanni period. Particularly characteristic at Brak are very large, urn-like vessels with geometric ornament on the upper rim surface (as on Rimah pot 1056) and “grain measures” like 863. At Brak such grain measures with bird ornament are manufactured in both Nuzi and Khabur wares, as is vessel type 1055 at Rimah. The evidence for the use of bird ornament is discussed above (p. 53). In general, animal representation is rare, but includes the Nuzi ware horned ?bovine animal of Plate 23b, and the remarkable maned creature depicted on 1055; see also the pattern of leonine animal and checkerboard, Plate 19a, which is possibly Late Old Babylonian in date.

Both glazed pottery and glass vessels appear for the first time in Mitanni levels. Although the use of glass for beads and moulded objects is known before this time, the manufacture of core-moulded vessels is first attested in Mitanni levels. At Rimah a single glass bottle was found in Site A Level 2c (early Mitanni, TR 2619, locus A343), while most examples came from the later Mitanni and early Middle Assyrian periods. The largest single collection of glass bottles came from the construction fill for Level C4 (Middle Assyrian). Here enormous numbers of glass, frit and faience beads and other objects were recovered, presumably deriving from the destruction debris marking the end of Mitanni control. A large number of similar objects were also found in the Mitanni shrine. At Rimah glazed vessels do not appear before the later Mitanni levels and are rare at all times. In the Mitanni period they are more common in the Great Temple than on Site C (Figure 46), perhaps a reflection of their “value”. Mitanni examples include bowl 151 and jars 920 and 921.

Among the most easily recognised Mitanni pottery are examples of impressed grey ware with white inlay (Plate 23c-e; pots 1202, 1205, 1209-11). Plate 19e illustrates a rare red-slipped example. The

fabric is buff and the surface red-slipped and burnished; red paint has been rubbed into the incised pattern, over which part of the design has been inlaid in white. The underlying red pigment has diffused into the white inlay creating a pink effect. Plate 23e (TR 3325) superficially resembles a handle, but the inlay occurs on the top and sides only; both fragments e and f would appear to come from similarly shaped objects. Plate 23f is unusual in that the decoration is reminiscent of contemporary granulated ornament on gold and glass (*Iraq* 49, 1987, Pl. 39a,c). At both Rimah and Brak the Mitanni impressed ware with white inlay is uncommon, in apparent contrast with its occurrence at the more eastern site of Nuzi.

e) Middle and Late Assyrian Pottery

As for the Middle Assyrian pottery there is little to add to the extensive information contained in the plates, column graphs and accompanying notes. Such pottery, moreover, is now well known from contemporary sites such as Shaikh Hamad and Tell Bderi (see the very comprehensive detail of Pfälzner 1995). Especially diagnostic of this period is the very distinctive carinated bowl type illustrated on Plates 28-30 and the nipple-based beaker. As noted above, the readily identified red-edged bowls characterise both Mitanni and Middle Assyrian levels while, at least at Rimah, piecrust potstands continue throughout the 14th century. The glazed sherd illustrated on Plate 19e (yellow and blue petals with white outline), probably a jar shoulder but conceivably a fragment of a polychrome glazed wall cone, is recorded as deriving from a secure Middle Assyrian context (C300, in a deposit of glass and beads from beneath an Area C Phase 3 wall); the only other similarly patterned glazed vessel is TR 2607 which was found in upper fill on Site C during the excavations in 1965 and is probably Late Assyrian in date but may be earlier (Carter 1967, Pl 9). In shape similar to jar 948, it is decorated with a patterned glaze consisting of two bands of yellow triangles on the shoulder of the vase, the rest of the vessel being dipped in green glaze. Such patterned vessels are otherwise unknown before the Late Assyrian period. Among the Middle Assyrian glazed pottery from Rimah are bowls 1221 and Plate 25a. We have found no dimpled beakers comparable with those published from Nuzi (Starr 1939, Pls 77-78) at either Brak or Rimah. At Rimah the Middle Assyrian occupation of the Great Temple is well-documented, the pottery from batches A20 and A228, for example, being directly associated with Middle Assyrian tablets of the time of Shalmaneser I and Tukulti-Ninurta I, which mark the end of Level 1b.

The Late Assyrian pottery presents more problems. We know that Rimah had been resettled at least as early as 800 BC but, as noted above, we have evidence for only two levels of apparently continuous Late Assyrian occupation in Area C (Level 1) and a single level (2) in Area D; these cannot have spanned a long period of time and strongly suggest a date no later than the 8th century for Late Assyrian Rimah. Judging by the valuable objects that remained in the destroyed Late Assyrian temple, the site suffered a violent end, but we have no direct evidence for the date of this destruction. The differences between the Late Assyrian pottery from Rimah and that from Fort Shalmaneser at Nimrud, the latter unequivocally dated to the destruction in 612 BC, also support the abandonment of Rimah at some earlier time. In particular, at Nimrud, the red-burnished tripod vessels (Rimah bowl 496) are more common in the late 8th century town wall houses than in Fort Shalmaneser (*Iraq* 21, 1959, Pl. 35:15,16) and we found, *inter alia*, no deep bowls comparable with Rimah 504-505. One would not necessarily expect to find Late Assyrian palace ware at a provincial site such as Rimah, but a comparison of the Plate 50 small cups (*istikanat*) or the bowls illustrated on Plate 55 with those published from Fort Shalmaneser highlights the differences in the pottery from the two sites. At Rimah some of the Late Assyrian graves were dug from beneath the earliest level of house foundations, allowing us to date the associated pottery (*inter alia* bowl 88, jar 951, beaker 670) to c. 800 BC, or slightly earlier. Late Assyrian glazed vessels include jar 925 and those illustrated on Plates 25 and 26. A few examples of Late Assyrian impressed ware were also recovered (e.g. Plate 19e). A considerable number of Late Assyrian burials were contained in large jars (p. 45, above).

f) Post-Assyrian Pottery

We owe to Dr St John Simpson the identification of the small quantity of Parthian and Islamic pottery found at Rimah. Both surface pits on Site A and the Site D farmhouse produced medieval Islamic jars decorated with combed patterns (969-72, 975). The glazed lamp 1227 from the surface of Site C and cooking pot 973 are of similar date. Glazed jar 974, from another surface pit on Site A, provides the only clear evidence of Parthian occupation at Rimah.

Abbreviations

AEM *Archives Épistolaires de Mari*

ARM *Archives Royales de Mari*

Brak I Oates, D., J. Oates and H. McDonald, in press.

LA Late Assyrian

MA Middle Assyrian

MARI *Mari Annales de Recherches Interdisciplinaires*

OB Old Babylonian

OBTR Dalley, S., C.B.F. Walker and J.D. Hawkins 1976.

TR Tell al Rimah Catalogue number

UVB *vorläufer Bericht über die von dem Deutschen Orient-Gesellschaft Ausgrabungen in Uruk-Warka*

ZL Zimri-Lim

~ same or similar

Bibliography

Andrae, W. 1925. *Coloured Ceramics from Ashur*. London: Kegan Paul.

Ball, W., Tucker, D. and Wilkinson, T.J. 1989. "The Tell al-Hawa Project: archaeological investigations in the North Jazira", *Iraq* 51, 1-66.

Baqir, T. 1945. "Iraq Government Excavations at Aqar Quf, second interim report 1943-44", *Iraq* supplement.

Carter, T.H. 1967. "Tell al-Rimah. The Campaigns of 1965 and 1966", *Archaeology* 17/4 282-89.

Charpin, D. 1985. "Les archives du devin Asqudum dans la Résidence du Chantier A", *MARI* 4, 453-62.

Charpin, D. and Durand, J-M. 1985. "La prise du pouvoir par Zimri-Lim", *MARI* 4, 293-343.

Charpin, D. and Durand, J-M. 1987. "Le nom antique de Tell Rimah", *Revue d'Assyriologie* 81, 125-46.

Charpin, D., Joannès, F., Lackenbacher, S. and Lafont, B. 1988. *AEM* I/2.

Curtis, J. 1982. *Fifty Years of Mesopotamian Discovery*. British School of Archaeology in Iraq (London).

Dalley, S., Walker, C.B.F. and Hawkins, J.D. 1976. *The Old Babylonian Tablets from Tell al Rimah*. British School of Archaeology in Iraq.

Eidem, J. 1989. "Some Remarks on the Iltani Archive from Tell al Rimah", *Iraq* 51, 67-78.

Hamlin, C. 1974. "The early second millennium ceramic assemblage of Dinkha Tepe", *Iran* 12, 125-53.

Hrouda, B. 1957 "Die bemalte Keramik des zweiten Jahrtausends in Nordmesopotamien und Nordsyrien", *Istanbuler Forschungen* 19.

Hrouda, B. 1975. "Habur-Ware", *Reallexikon der Assyriologie* 4, 29-31.

Hrouda, B. 1989. "Die Habur-Ware in neuerer Sicht", in *Anatolia and the Ancient Near East*, eds. Emre, K., Mellink, M., Hrouda, B., Özgüç, N. 205-14.

Jean, C.F. 1939. "Lettres de Mari", *Revue Études Sémitiques*.

Kramer, C. 1977. "Pots and Peoples", in *Mountains and Lowlands*, eds. Levine, L.D. and Young, T.C. Jr., *Bibliotheca Mesopotamica* 7.

Lloyd, S. 1938. "Some Ancient Sites in the Sinjar District", *Iraq* 5, 123-42.

- Mallowan, M.E.L.M. 1937. "Excavations at Tall Chagar Bazar and an Archaeological Survey of the Habur Region", *Iraq* 4, 91-177.
- Mallowan, M.E.L.M. 1949. "Excavations at Brak and Chagar Bazar", *Iraq* 9, 1-259.
- Margueron, J-C. 1975. "Quatre campagnes de fouilles à Emar (1972-74)", *Syria* 52, 53-85.
- Meijer, D. 1986. *A Survey of Northeastern Syria*, Nederlands Hist.-Arch. Inst., Istanbul
- Munn-Rankin, J.M. 1956. "Diplomacy in Western Asia in the Early Second Millennium BC", *Iraq* 18, 68-110.
- Oates, D. 1965. "The Excavations at Tell al Rimah 1964", *Iraq* 27, 62-80.
- Oates, D. 1966. "The Excavations at Tell al Rimah 1965", *Iraq* 28, 122-39.
- Oates, D. 1967. "The Excavations at Tell al Rimah 1966", *Iraq* 29, 70-96.
- Oates, D. 1968. *Studies in the Ancient History of Northern Iraq*, Oxford.
- Oates, D. 1968. "The Excavations at Tell al Rimah 1967", *Iraq* 30, 115-38.
- Oates, D. 1970. "The Excavations at Tell al Rimah 1968", *Iraq* 32, 1-26.
- Oates, D. 1972. "The Excavations at Tell al Rimah 1971", *Iraq* 34, 77-86.
- Oates, D. 1973. "Early Vaulting in Mesopotamia", in *Archaeological Theory and Practice*, ed. Strong, D. London, Seminar Press.
- Oates, D. 1990. "Innovations in mud-brick: decorative and structural techniques in ancient Mesopotamia", *World Archaeology* 21, 388-406.
- Oates, D., Oates, J. and McDonald, H., in press. *Excavations at Tell Brak I, The Mitanni and Old Babylonian Periods*.
- Oates, J. 1959. "Late Assyrian Pottery from Fort Shalmaneser (Nimrud)", *Iraq* 21, 130-46.
- Oates, J. 1974. "Late Assyrian Temple furniture from Tell al Rimah", *Iraq* 36, 179-84.
- Page, S. 1968. "The Tablets from Tell al-Rimah 1967: a preliminary report", *Iraq* 30, 87-97.
- Page, S. 1968. "A Stela of Adad-Nirari III and Nergal-Ereš from Tell al Rimah", *Iraq* 30, 139-153.
- Parker, Barbara 1975. "Cylinder Seals from Tell al Rimah", *Iraq* 37, 21-38.
- Parker, Barbara 1977. "Middle Assyrian Seal Impressions", *Iraq* 39, 257-68.
- Pfälzner, P. 1995. *Mittanische und Mittelassyrische Keramik*. Ausgrabungen Tall Šeh Hamad 3. Berlin, Dietrich Reimer Verlag.
- Postgate, J.N. 1970. "A Neo-Assyrian Tablet from Tell al Rimah", *Iraq* 32, 31-5.
- Postgate, J.N. 1978. "An inscribed jar from Tell al Rimah", *Iraq* 40, 71-5.
- Reade, J.E. 1968. "Tell Taya (1967): summary report", *Iraq* 30, 234-64.
- Reade, J.E. 1982. "Tell Taya", in Curtis 1982, 72-8.
- Saggs, H.W.F. 1968. "The Tell al Rimah Tablets", 1965, *Iraq* 30, 154-74.
- Starr, R.F.S. 1937, 1939. *Nuzi*. Harvard.
- Stein, D.L. 1984. "Khabur Ware and Nuzi Ware: their origin, relationship and significance", *Assur* 4, 1.
- Veenhof, K-R. 1985. "Limu of the Later Old Assyrian Period and Mari Chronology", *MARI* 4, 191-218.
- Walker, C.B.F. 1970. "A Foundation-Inscription from Tell al Rimah", *Iraq* 32, 27-30.
- Whiting, R.M. 1990. "Tell Leilan/Šubat-Enlil: chronological problems and perspectives", in *Tall al-Hamidiya* 2, Eichler, S., Wäfler, M. and Warburton, D. Universitätsverlag Freiburg Schweiz.
- Wiseman, D.J. 1968. "The Tell al Rimah Tablets, 1966", *Iraq* 30 175-205.
- Woolley, C.L. 1955. *Alalakh, an Account of the Excavations at Tell Atchana*. Oxford.

CHAPTER 3

Notes to the Plates

The following notes contain column graphs illustrating the distribution through the various level at Tell al Rimah of profiles, rims and sherds of certain key types of pottery. The vertical axis of each graph indicates the number of examples found (of rims, profiles, sherds, batches, bases as specified) including those illustrated on the relevant plates. The horizontal axis shows the levels in which the pots were discovered. The darker columns on the left represent Site A and the lighter on the right, Site C. For a stratigraphic summary and correlation of the corresponding levels see p. 44.

Abbreviations used: Tops = Topsoil LA = Late Assyrian MA = Middle Assyrian

Graphs have not been included for those types of pottery found exclusively in single levels, for instance Plate 56 Late Assyrian, nor for those plates where very few examples other than those illustrated have been found, for instance Plate 80 Miniature vessels. The data on which the graphs have been based were obtained from notes made on the pottery during each season of excavation, with most of the material coming from the last two seasons, when work was largely concentrated on Site C. This may account to some extent for the discrepancies apparent between the numbers of examples found on Site A and those on Site C, although these may also reflect the difference in the occupation patterns between the Temple of Site A and the domestic buildings and Palace of Site C. The information available is by no means definitive and the graphs must be used only as a rough guide to the quantitative distribution of individual types. In particular, small numbers of sherds in the upper levels where the principal distribution lies in the lower levels are unlikely to represent original contexts but most probably derive from earlier levels. Similarly, small quantities of sherds in earlier levels may have been found out of context. Site B, which consisted purely of Late Assyrian occupation levels, and Site D, which produced little pottery, have both been excluded from the graph data. Roman room numbers in plate references refer to the Old Babylonian levels only (Site A Level 3; Site C Levels 6 and 7); Arabic numerals are used elsewhere.

Plates 28 – 30 Carinated bowls – Middle Assyrian

Plates 28, 29 and 30 illustrate the open bowl most typical of Level 1 on Site A and of Levels 2-4 on Site C. There are a number of carinated bowl types which occur also in the Mitanni levels (Pots 15-21). As a general rule, the bowls with larger rim diameters have ring bases, while smaller bowls have flat bases. The quality of manufacture is not particularly good and ranges widely from coarse, badly-finished ware to finer, well smoothed examples. There are a few examples of bowls with traces of burning on the rim – Pot 41 and two similar to Pots 28 and 41 – see notes to Plates 52, 53 and 54. Cf. *Figures 16 and 17*.

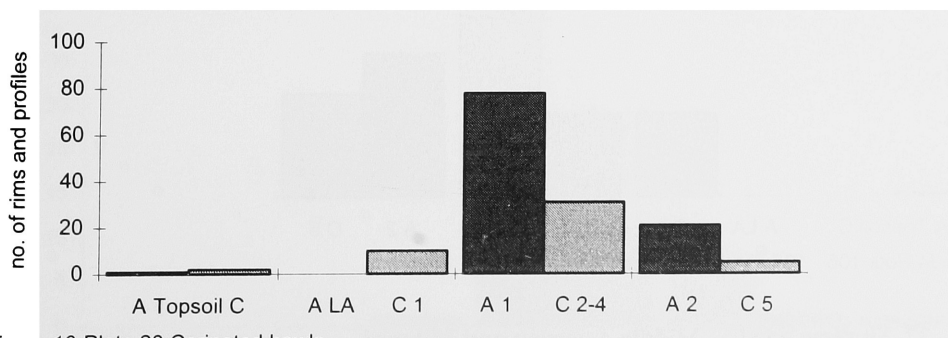

Figure 16 Plate 28 Carinated bowls

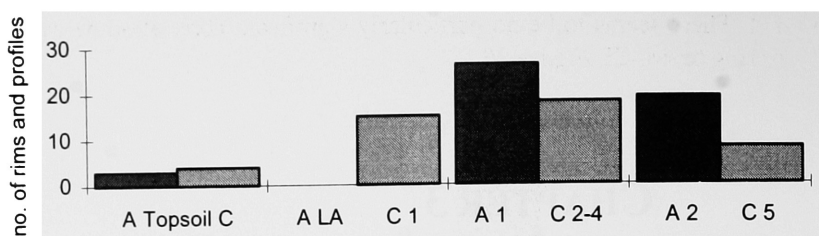

Figure 17 Plate 29-30 Carinated bowls

Plate 31 Carinated bowls – Middle Assyrian and Mitanni

Smaller bowls have simple rims, almost vertical above the carination and the bases are invariably flat. There appear to be two distinct types of small carinated bowl – one is deeper, more upright above the carination (Pots 51-57), while the other is shallower, with the carination much nearer to the rim (Pots 58-73). Both these types seem to be more or less evenly distributed through the Middle Assyrian and Mitanni levels, especially on Site A. Cf. *Figure 18*.

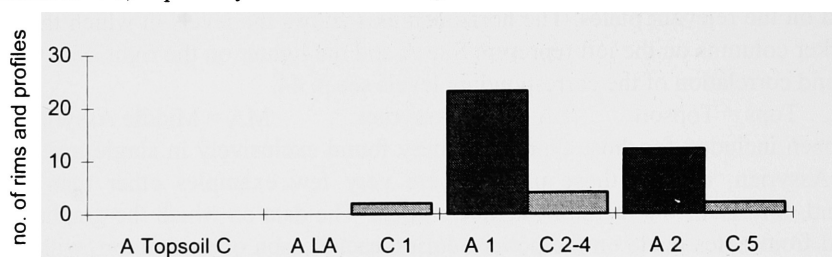

Figure 18 Plate 31 Carinated bowls

Plates 32 – 33 Carinated bowls – Mitanni

These plates include a miscellaneous collection of small carinated bowls, flat bases on Plate 32 and ring bases on Plate 33. They are generally well finished and sometimes have a burnished surface. Two bowls, Pots 84 and 87, show traces of burning on the rim – see notes to Plates 52, 53 and 54.

Plate 34 Red-rimmed bowls – Middle Assyrian and Mitanni

Red-rimmed shallow bowls overlap in time with Middle Assyrian carinated bowls and occur with much greater frequency on Site C than Site A. Pots 105-109 are the most common types, while Pots 119-121 are examples of bowls of a different type usually found in later levels. The red-slipped rim and plain interior of the bowls was almost always originally burnished, although the burnish is very often worn away from usage on the interior surface. Bowls with larger rim diameters generally have ring bases. Cf. *Fig. 19*.

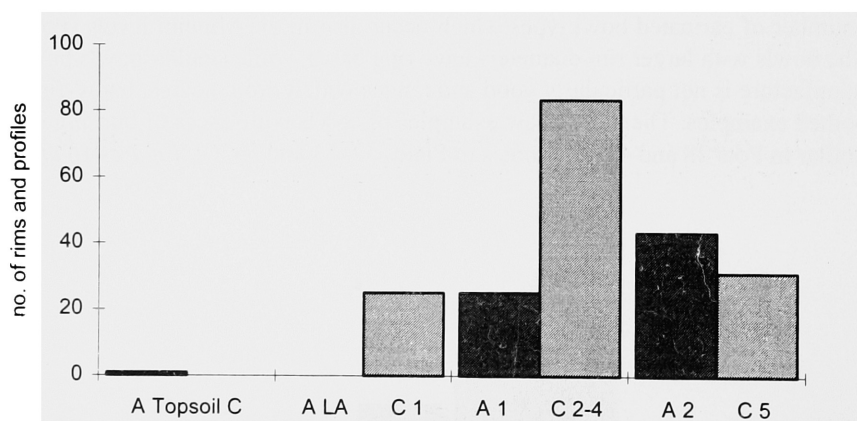

Figure 19 Plate 34 Pots 105 - 108 Red-rimmed shallow bowls

Plates 35 – 36 - 37 Shallow bowls – Middle Assyrian and Mitanni

This is the unpainted version of the red-rimmed variety, again occurring in larger numbers on Site C than on Site A. Although this type is found in both earlier and later levels, the optimum period of use is in the Middle Assyrian levels, in which context it rivals the carinated bowls of Plates 28 and 29 as the

most popular type of open bowl. There seems to be no particularly significant correlation between the size of rim diameters and floor or ring bases. Cf. *Figure 20*.

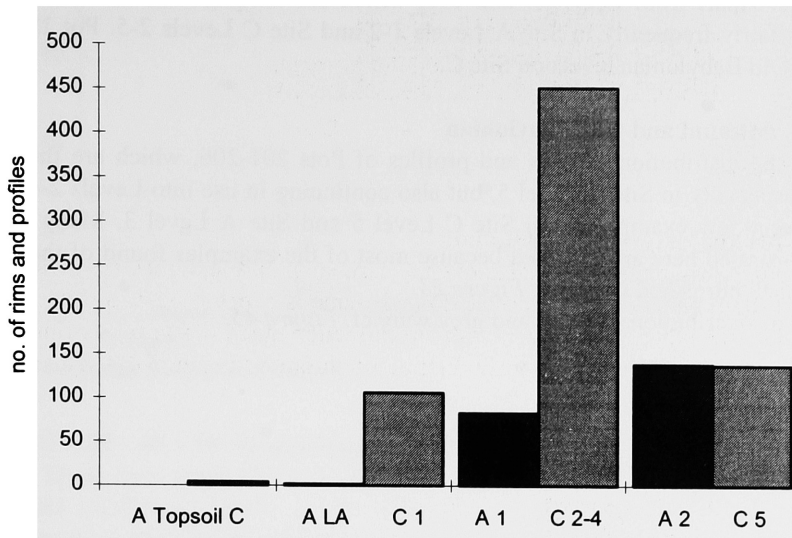

Figure 20 Plates 35-37 Shallow bowls

Plate 38 Pots 176 – 182 Bowls – Middle Assyrian and Mitanni

This is a type of bowl that seems fairly equally distributed through Site C Levels 2-5, but is quite rare on Site A, where bowls of this general type are found in very small numbers in almost all levels. Pot 179 is the most frequently occurring bowl, is very often made of a light buff or cream ware, sometimes with a cream or white burnished slip, is well finished and is particularly diagnostic of Site C Mitanni Level 5. Cf. *Figure 21*.

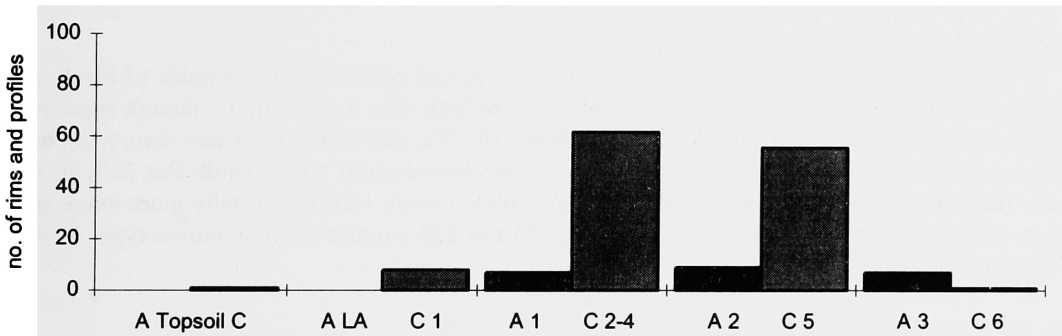

Figure 21 Plate 38 Pots 176 - 182 Bowls

Plate 38 Pots 183 – 189 Bowls – Middle Assyrian

These are good examples of a type which is largely exclusive to Site A Level 1 and Site C Levels 2-4, and is found in similar, though small, numbers on both sites. Cf. *Figure 22*.

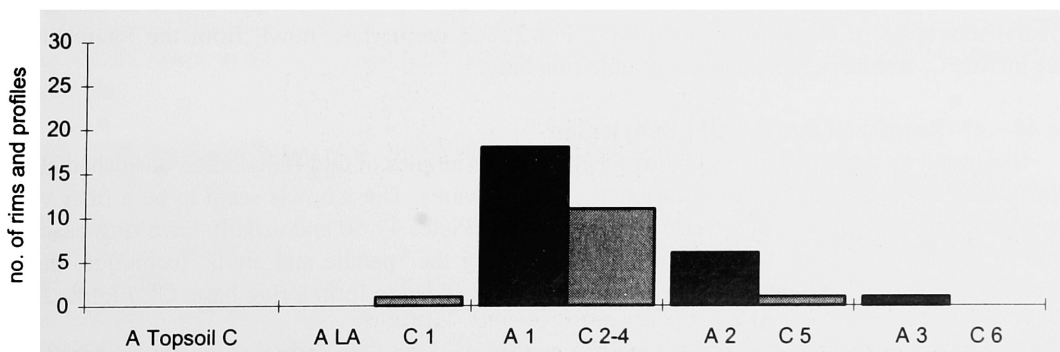

Figure 22 Plate 38 Pots 183 - 189 Bowls

Plate 39 Bowls – Middle Assyrian and Mitanni

A mixed collection of bowls, mostly Middle Assyrian and Mitanni, but with two possibly earlier examples, Pots 195 and 196. Apart from Pots 196 and 198, which are unique, each of these bowls illustrates a type that occurs fairly frequently in Site A Levels 1-2 and Site C Levels 2-5. Pot 192 is a type that appears as early as Old Babylonian levels on Site C.

Plate 40 Burnished bowls – Mitanni and Old Babylonian

The graph illustrates the distribution of rims and profiles of Pots 201-206, which are the most frequently occurring types, especially in Site C Level 5, but also continuing in use into Levels 2-4. Pots 207-212 are confined to a very few examples from Site C Level 5 and Site A Level 3. Many of the unburnished pots that are illustrated here are included because most of the examples found of the same types are in fact of grey or black burnished ware. Cf. *Figure 23*.

For a graph showing the distribution of black and grey ware cf. *Figure 45*.

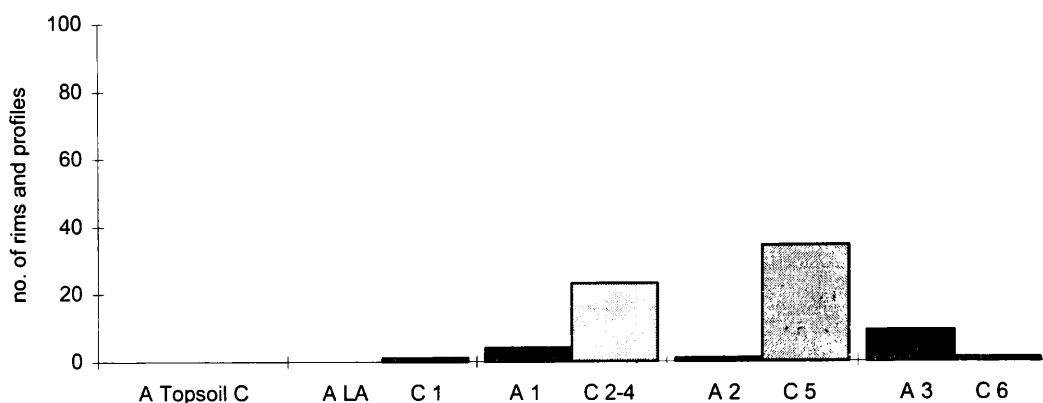

Figure 23 Plate 40 Pots 201 - 206 Burnished bowls

Plate 41 Burnished bowls – Old Babylonian

The types of bowl illustrated on this plate are a mixed collection of examples of black or grey burnished wares typical of the Old Babylonian levels at both Site A and Site C, though these profiles sometimes occur in red or buff burnished ware (Pots 219, 222, 224 and 226). There were many smaller examples found of Pots 213 and 215, which are both characteristic types, while Pot 217, in itself a unique find, is illustrative of a fairly common type of ribbed bowl, with ribs usually more numerous and less prominent than this example. Pots 221, 226, 227 and 228 are also fairly common types in the Old Babylonian levels on both sites.

Plate 42 Bowls – Old Babylonian

A mixed collection of deep bowls typical of Old Babylonian levels at Site C and Site A, generally made of medium coarse ware which in some cases was fairly well smoothed.

Plate 43 Bowls – Mitanni and Old Babylonian

Included on this plate are a series of cream-to-pink ware bowls, usually highly burnished. Pot 243 is particularly diagnostic for Site C Level 5 and occurs most frequently, while Pots 242 and 244 are alternative examples of the same general type. Pot 252 is the earliest bowl, from the Shamshi-Adad Palace on Site C, and has a most unusual double ring base.

Plate 44 – 45 Burnished bowls – Old Babylonian

Illustrated on these two plates are the most typical examples of Old Babylonian burnished shallow bowls, usually in black or grey, but occasionally in buff, wares. These bowls seem to be a finer version of the coarse and ubiquitous rough-based shallow bowl of Plates 47-50 and usually have ring bases. The method of manufacture is by handbuilding, possibly using the “paddle and anvil” technique, that is a lump of clay beaten over a hump mould, with a coil of clay added to form a ring base. Cf. *Figure 24*.

Plate 46 Burnished bowls – Old Babylonian

A further selection of shallow bowls and platters, all handbuilt, mostly of grey or black burnished ware and all typical of Old Babylonian levels at Site C and Site A.

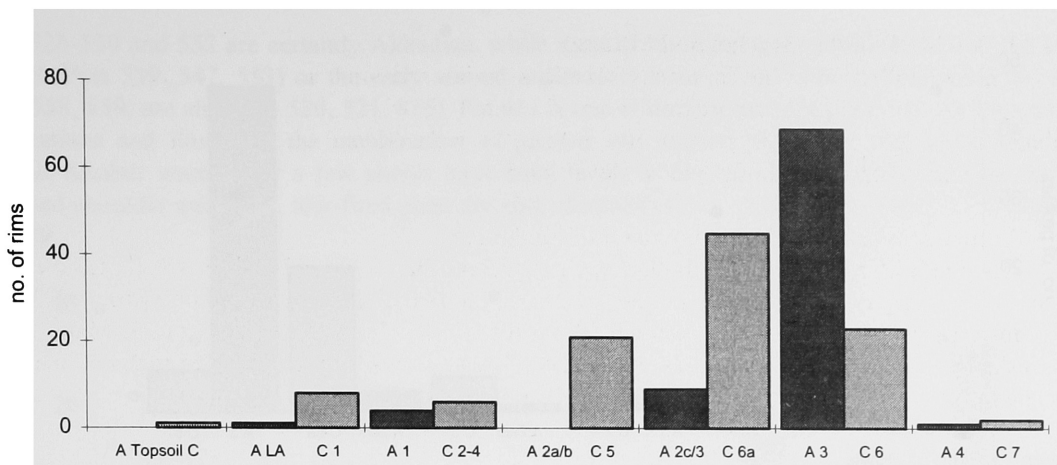

Figure 24 Plates 44-45 Burnished bowls

Plate 47 – 48 – 49 – 50 Rough-based shallow bowls – Old Babylonian and Mitanni

These four plates illustrate the most common type of shallow bowl found in Old Babylonian and Late Old Babylonian levels. It was invariably handmade of coarse ware, often warped in firing and seems to have been made either by pressing a lump of clay into a mould or form composed of rough material such as wood, which leaves an extremely rough exterior surface which the potter has made no attempt to smooth, or by a similar “paddle and anvil” technique as described above, using very rough wooden paddles. The paucity of examples from the Temple on Site A and the fact that it is found much more frequently in the domestic quarters of the Old Babylonian Palace on Site C and the levels immediately above, may indicate that this type of bowl was manufactured exclusively for domestic use. Cf. Figure 25.

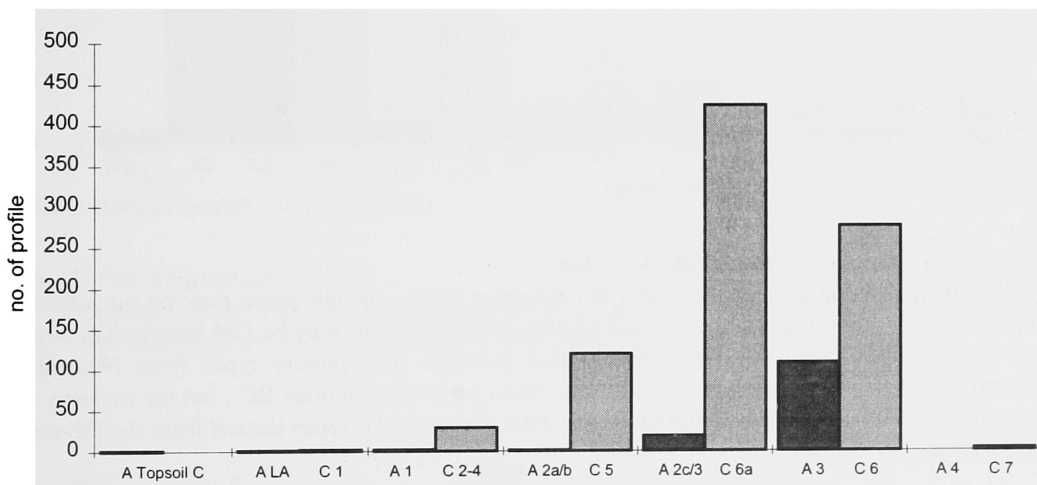

Figure 25 Plates 47-50 Rough-based shallow bowls

Plate 51 Bowls Old Babylonian

These bowl types are examples of a slightly deeper version of the Old Babylonian shallow bowls of Plates 47-50, made in the same way and, unusually, found in greater numbers on site A than Site C. Cf. Figure 26.

Plates 52 – 53 – 54 Small bowls, lids and lamps – Old Babylonian

These three plates illustrate the most common small bowls found in Old Babylonian levels, especially on Site C. Plate 52 includes two unusual groups of bowl types:– 1) Pots 424-427 have rounded, string-cut bases with a single hole in the centre, whose function is unknown. 2) Pots 428-430 have either a hollow or solid knob in the centre and may have been used as lids. Several examples were found in batches C445 and C395 associated with the wine jars illustrated on Plate 90. All these small bowls are thrown on the wheel and are well finished. All three plates provide several examples of bowls with traces of burning at one or more points on the rim, which probably indicate that they were used as small saucer lamps (see also Pots 41, 84, 87 and 519). Cf Figure 27.

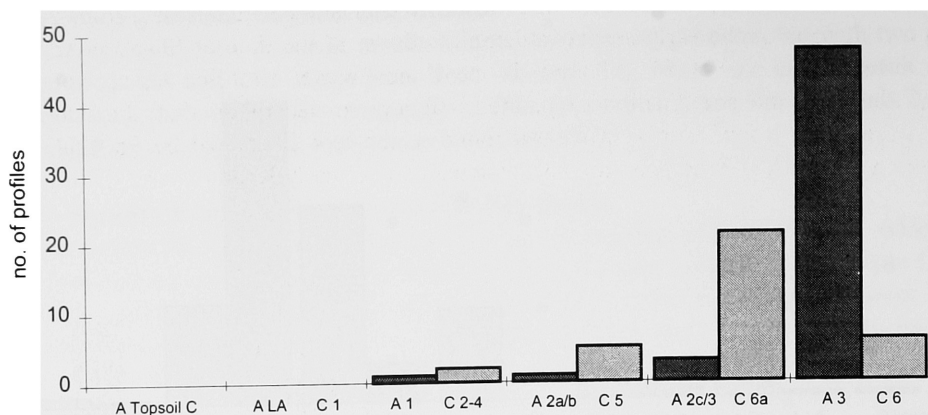

Figure 26 Plate 51 Bowls

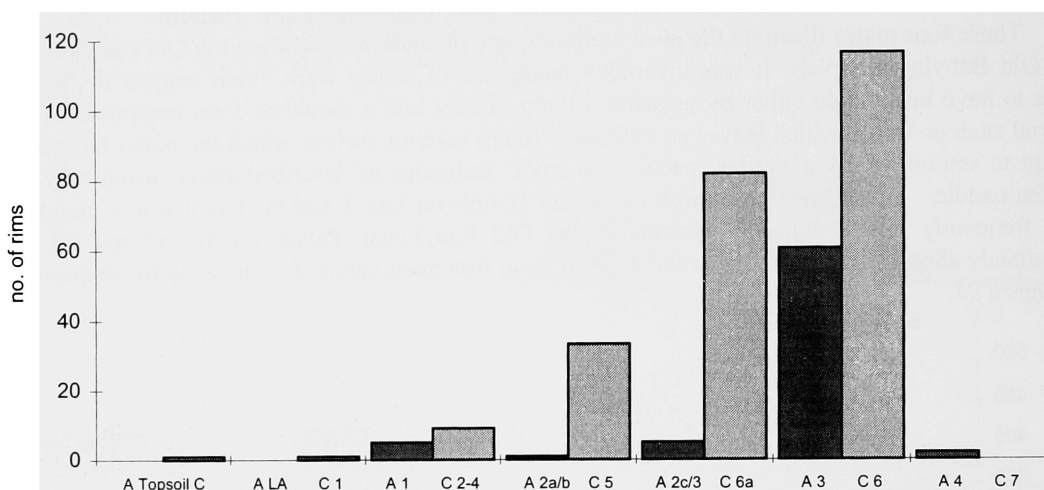

Figure 27 Plates 52-54 Small bowls, lids and lamps

Plate 55 – 56 Bowls – Late and Middle Assyrian

A mixed collection of pottery from Late Assyrian levels, though some may be out of context (Pots 477 and 478, although found in Late and Middle Assyrian levels, may be Old Babylonian bowls of the type illustrated on Plate 53). Some bowls have parallels with pottery types from Nimrud Fort Shalmaneser and therefore may be dated to the late 7th to early 6th centuries BC, but the majority seem to correspond with 8th century types elsewhere, eg. Pots 496 and 497, types known from the 8th century Town Wall houses at Nimrud.

Plate 57 Incised and decorated vessels

This plate shows examples of unusual or unique pottery types from various levels, with very few examples of similar types found.

Plate 58 Red-painted bowls – Old Babylonian

A selection of bowls with red painted decoration, most from secure Old Babylonian contexts. Pots 512 and 513 have parallels in the pattern on Pot 831. Pots 514, 515 and 516 are unique. Pots 517-519 represent a fairly common type with the very distinctive Old Babylonian feature of random paint splashes inside, other examples of which can be seen on Plate 74. Pot 520 dates from the Site C Shamshi-Adad Palace and Pot 521 from a pre-Shamshi-Adad level on Site A. Such painted-and-incised decoration is characteristic of the earliest Khabur ware.

Plate 59 – 60 Late third and early second millennium pottery

Plates 59-60 include material of both early second and late third millennium date, recovered largely from undifferentiated fills in Area AS (pp 20-22). Pot 544 is of very early third millennium date,

Pots 526-530 and 552 are certainly Akkadian, while most of the illustrated vessels date from the Ur III period (Pots 539, 547, 553) or the early second millennium down to the time of Shamshi-Adad (Pots 549, 558, 559; see also Pots 520, 521, 875). Pot 621 is one of the few well-stratified vessels from the AS excavations and illustrates the combination of painted and incised decoration that characterises the earliest Khabur ware. Only a few sherds have been found of the type illustrated by Pot 558, but the grooved shoulder and thick, low-fired paint are also characteristic of early Khabur ware. Cf. *Figures 28 and 29*.

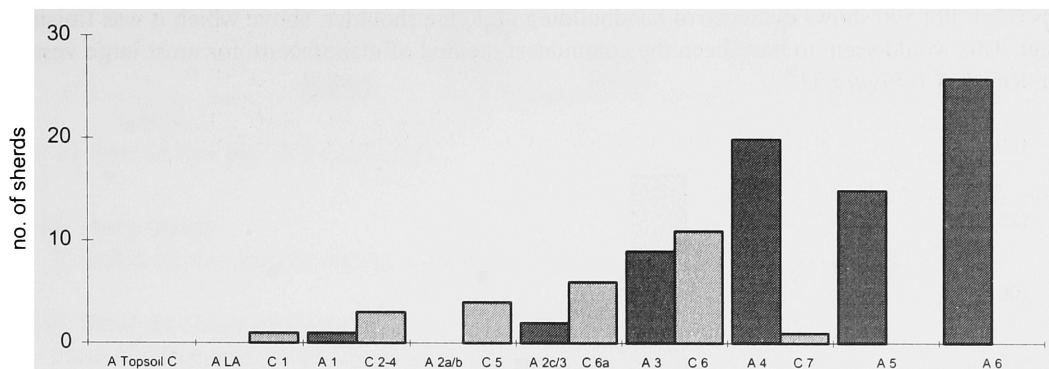

Figure 28 Plate 59 Pots 527 - 530 Fine bowls

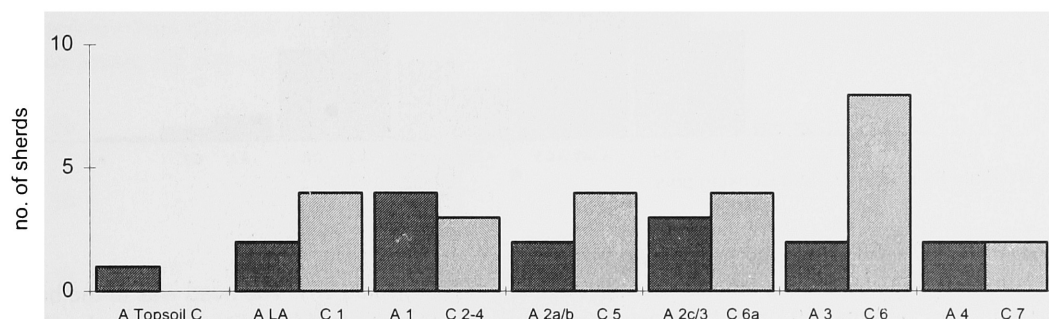

Figure 29 Plate 60 Pot 558 Painted jar sherds

Plates 61 – 62 Hole-mouth bowls

Two plates of the most typical examples of hole-mouth bowls from Middle Assyrian and Mitanni levels; some examples are found in earlier Old Babylonian levels. Cf. *Figure 30*.

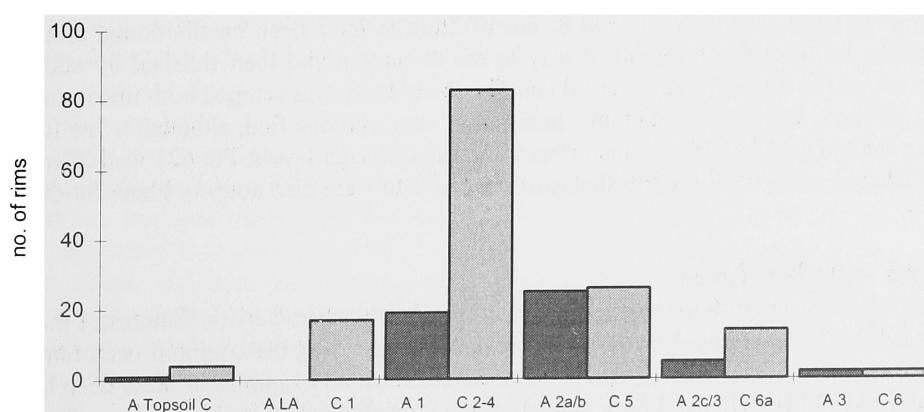

Figure 30 Plate 61-62 Hole-mouth bowls

Plate 63 Cooking pots

The graph illustrates quite clearly the even spread of pottery made of “cooking ware” throughout all levels earlier than Late Assyrian. The term “cooking ware” used in the catalogue describes the largely unchanging type of coarse ware always used for cooking vessels – a ware extremely high in grit or mica

temper with a black core and black, brown or red surface. Cooking pots are almost invariably round-based with the base very often burnt away from overuse and sometimes mended in antiquity with a potsherd and plaster seal. Burnishing of the whole exterior of the pot is a common feature, with many examples existing of an orange or brown burnished slip applied to the rim. There are no published illustrations of Late Assyrian cooking pots in this volume, as no complete profiles were found. However, from the rims and sherds found, it is possible to be sure that the most common rim type was a simple rolled rim on a hole-mouth rounded body, sometimes with small pointed lugs or small handles near the rim. 20 examples of these hole-mouth rims were found, of which 17 are from Level C1 and 3 are from Levels C2-4. Pot 590 shows evidence of handbuilding up to the shoulder, above which it was finished on a wheel. This would seem to have been the commonest method of manufacture for most large vessels at Tell al Rimah. Cf. *Figure 31*.

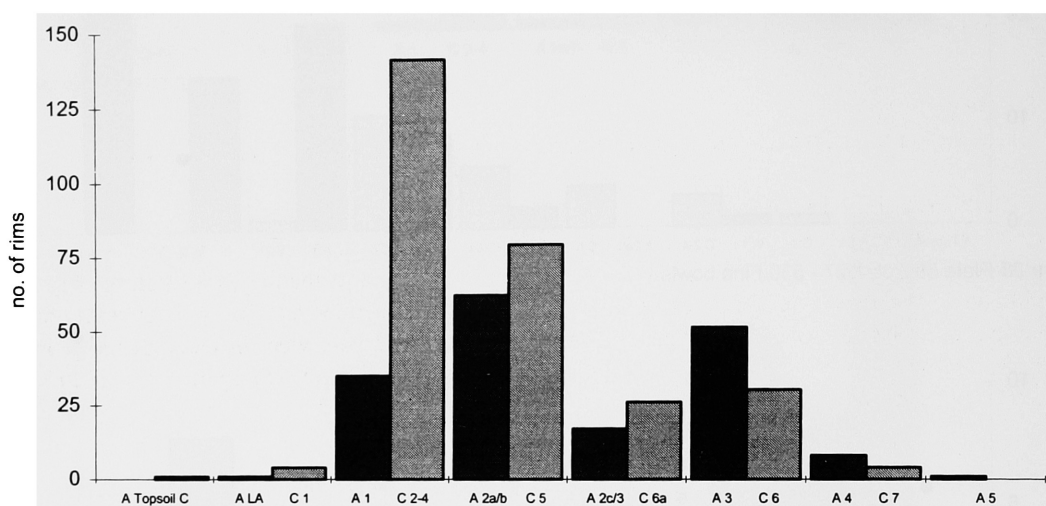

Figure 31 Plate 63 Pots 589 - 596 Cooking pots

Plate 63 Pots 597 – 603 Late Assyrian deep bowls

Pots 601, 602 and 603 together formed pot pot burial CG 5-68 (Plate 18). The head was in the base of Pot 601 and Pots 602 and 603 had their bases removed so that they could be fitted into each other to accommodate the length of the body. A few loose potsherds were placed over the feet, which extended beyond the last pot.

Plate 64 Deep bowls

Pots 604-607 are the most common types of deep bowl occurring in Site C Levels 2-5, almost always with a single horizontal groove below the rim and very often with an incised wavy line above. Close examination of Pot 615 shows the method of manufacture to have been handbuilding, either by coiling or being drawn up from a solid lump of clay to the carination and then finished by adding a further coil of clay in order to throw the rim on a wheel. The lower body was scraped both inside and out and then smoothed. Pot 612, with its internal ram's head spout, was a unique find, although a few further examples of similar, though not identical, channel rims were found in later levels. Pot 621 well illustrates the earliest type of Khabur ware, which is pre-Shamshi-Adad in date – see also notes to Plates 58-60. Cf. *Figure 32*.

Plate 65 Deep bowls – Old Babylonian

A well-stratified collection of large storage vessels illustrates the characteristic features of the Old Babylonian levels: cable ribs and incised wavy lines, broad ledge rims and the common occurrence of drainage holes in the centre of the base. No graph is included as almost all examples of these deep bowls come from well-stratified Old Babylonian levels, several of the illustrated examples having been found *in situ* in the Late Old Babylonian “kitchen” on Site C, as detailed on Table 1. These large vessels were handbuilt to the widest part and thereafter finished on the wheel, as described for Pot 615 above. They also often show faint horizontal rope impressions at intervals on the outside of the lower body, which would seem to indicate that the method of binding string or rope around the vessel to support it during construction was a common practice.

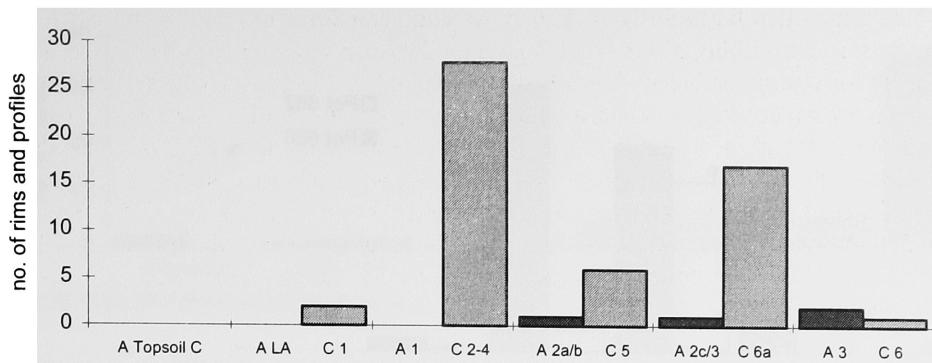

Figure 32 Plate 64 Pots 604 - 608 Deep bowls

Plate 66 Deep bowls

Included on this plate are rare or unique pots of unusual type and from various levels.

Plate 67 Straight-sided beakers

Plate 67 illustrates all the types of straight-sided beakers found in all levels, arranged in vertical columns according to level, with the latest levels on the left of the page and the earliest on the right. Pots 649, 650 and 652 show very faint traces of paint, which on all the painted examples is extremely fugitive and may be an indication that other unpainted examples illustrated here were in fact originally painted. The graph for Pots 648-654 shows quite clearly that the nipple-based cup was largely confined to Middle Assyrian levels. Cf. Figure 33.

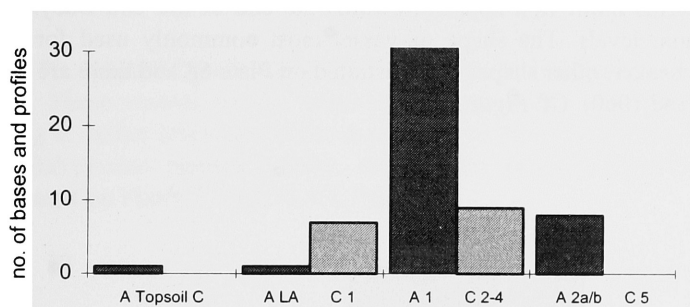

Figure 33 Plate 67 Pots 648 - 654 Nipple-based beakers

Pots 655-669 are examples of the footed beakers which are found in the same levels as the nipple-based beakers but which also occur in earlier Mitanni levels. The graph is compiled from data obtained from only two seasons of excavation on Site C only and was drawn in an attempt to ascertain whether there was in fact any difference in date between the beaker typified by Pot 662, whose base has a distinct external groove at the point where it joins the cup, and Pot 666, which has no groove. The result is somewhat inconclusive and all that can be said with any certainty is that grooved pedestals (Pot 662) are almost exclusively Middle Assyrian, while plain (Pot 666) are slightly more numerous in Mitanni levels.

All these beakers were thrown on the wheel. Close examination of the footed beaker bases has revealed two possible methods of manufacture, both used contemporaneously. Beakers with interior profiles that taper to a point (Pots 656, 661) were probable thrown upside-down, the pedestal bases pinched closed, and then turned when leather-hard to reach the finished shape. The beakers whose interior profiles flatten out above the solid pedestal base (Pots 655, 658) were probable thrown upright, with bases thrown separately and added at a later stage. Although both methods are found in both Middle Assyrian and Mitanni levels, throwing upside-down seems to have been the less common practice. Cf. Figure 34.

Pots 671, 673 and 674 are cups typical of the Old Babylonian Palace level on Site C. Beakers of the type of Pot 671 often have a single or double horizontal incised line on the outside just below the rim.

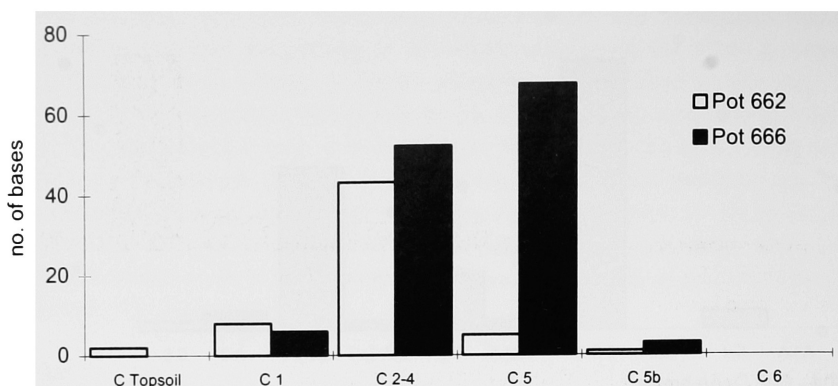

Figure 34 Plate 67 Pots 662 - 666 Bases from Site C 1968 and 1971 seasons

Plates 68 – 71 Nuzi ware

These plates include most of the painted sherds or profiles found in the later seasons of excavations at Tell al Rimah, all of which are rare or unique examples, especially the extremely fine ware on Plate 71. Sherds from early seasons are illustrated on Plates 21 and 22. The painted decoration known as “Nuzi ware” consists of horizontal bands of black, red or brown paint applied to the unslipped surface of the pot and then overpainted with patterns in white paint. The underlying dark paint often adheres very badly to the surface of the pot and is therefore sometimes poorly preserved. The earliest examples of Nuzi ware at Tell al Rimah coincide with the red-patterned ware of Plates 76 and 78 and certain motifs are common to both types. It is interesting to compare the bird designs of Pots 675 and 676 with those on Plates 76 and 78. This motif first appears towards the end of the Old Babylonian period and is most common in Mitanni levels. The shape of vessel most commonly used for Nuzi overpainted decoration was the footed beaker; other shapes are illustrated on Plate 68 and there are a few examples of larger vessels (Pots 1055 and 1060). Cf. *Figure 35*.

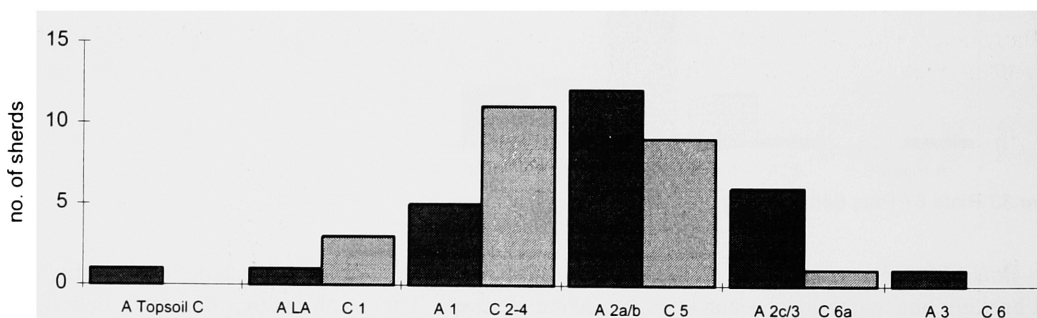

Figure 35 Plates 68 - 71 Nuzi ware

Plates 72 – 73 Undecorated shouldered beakers

These two plates illustrate the complete range of undecorated shouldered beakers with the latest examples on the left of Plate 72 and the earliest on Plate 73. Pots 760-772 are the most common small beakers found on the floor of the Old Babylonian Palace, Site C Level 6 and the Temple, Site A Level 3.

Plates 74 – 75 Painted shouldered beakers

A collection of beakers painted with plain horizontal stripes, mostly Late Old Babylonian, with a few later examples (Pots 778, 780 and 781). Pots 808-817 are examples of the most common type of small beaker from the very end of the Old Babylonian period, many of the illustrated examples having been found in the Site C “kitchen” of Level 6a.

Plates 76 Painted shouldered beakers – Mitanni and Old Babylonian

This plate shows a representative selection of red painted designs typical of Old Babylonian and Mitanni levels. Especially characteristic are the birds which are also found on larger vessels – cf. Plates 78 and 91. Cf. *Figure 36*.

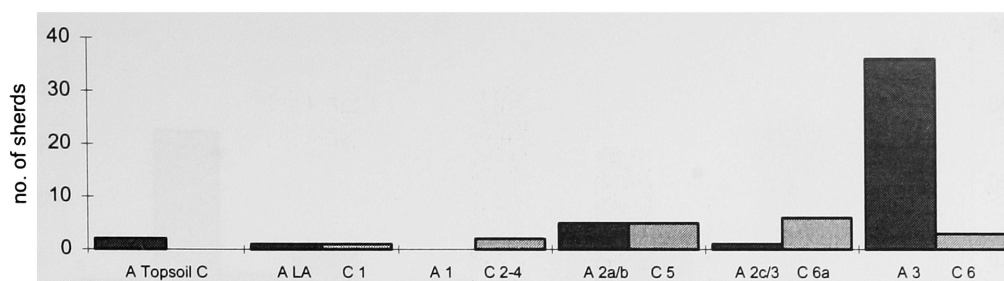

Figure 36 Plate 76 Painted shouldered beakers

Plate 77 Late and Middle Assyrian cups and Mitanni “grain measures”

Parallels can be found for the Middle Assyrian beakers at Nuzi and for the Late Assyrian “istikanat” at Nimrud Fort Shalmaneser (Pots 843-851). The small sample of “grain measures” is confined to Site A Levels 1-2 and Site C Levels 2-5. Pot 856 is an unusual example but conforms to the general type. Cf. *Figure 37*.

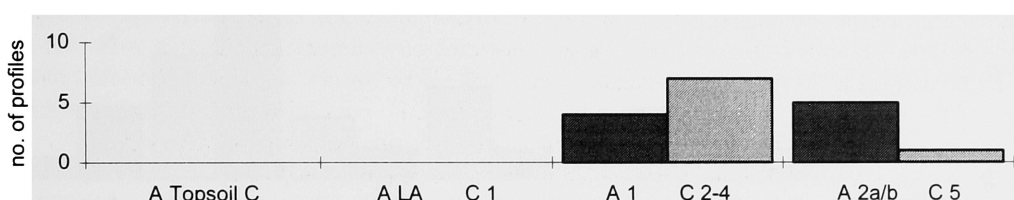

Figure 37 Plate 77 Pots 852 - 862 'Grain measures'

Plate 78 Painted “grain measures” – Mitanni to Old Babylonian

These vessels are the same basic shape as the unpainted examples of Plate 77, but generally belong to earlier levels and occur in greater numbers. They display some of the characteristic features of Old Babylonian painted pottery, such as the random splashes of paint internally which are well illustrated on Plates 74 and 76. Cf. *Figure 38*.

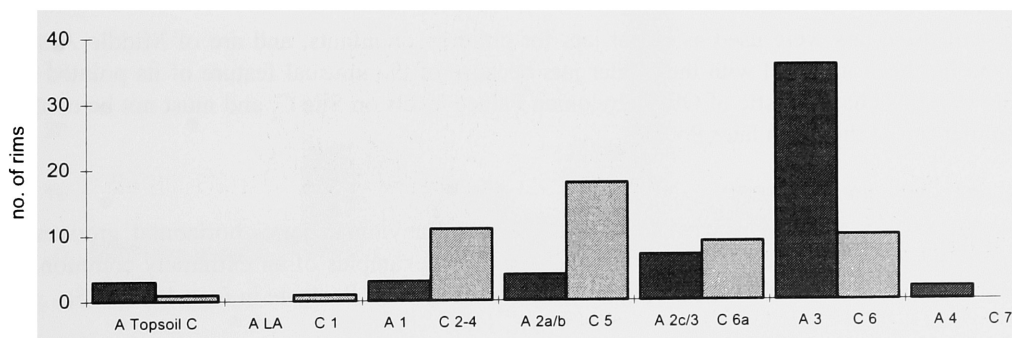

Figure 38 Plate 51 Painted 'Grain measures'

Plate 79 Small shouldered beakers – Old Babylonian

Pots 879-881 are examples of a distinctive type of fine ware cup, sherds of which are found in all levels, but which clearly belongs in early Old Babylonian levels and which shows close similarities with Pots 542 and 543 in ware and general shape, although the latter lack ribbing at the carination. Pots 886-889 are miniature versions of Pots 890-898, again a characteristic type of Old Babylonian levels. Cf. *Figures 39 and 40*.

Plate 80 Miniature vessels

Miniature pots are rare, invariably handmade and almost all unique.

Plates 81 – 82 – 83 Small jars, bottles and jugs

Pots 924-928 are paralleled by examples from Nimrud Fort Shalmaneser. TR 2607, a jar of the same shape as Pot 948 and also decorated in blue-green glaze, displays a pattern on the shoulder of yellow glaze triangles with white lines. Pot 964 is probably a wall cone.

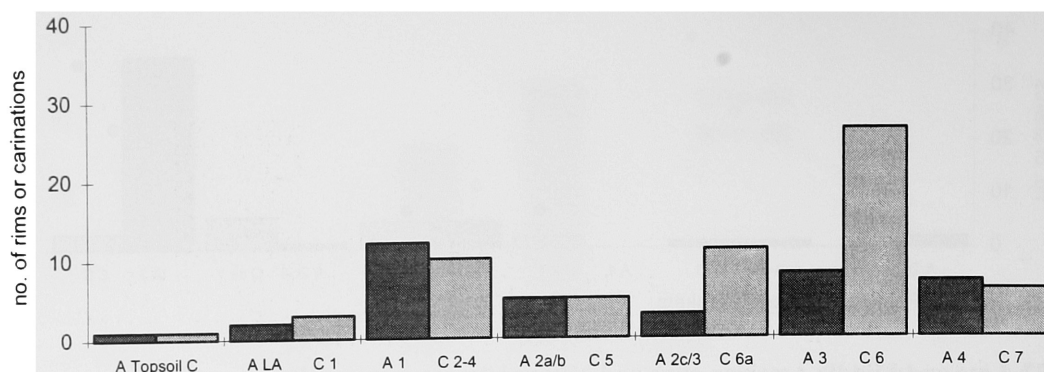

Figure 39 Plate 78 Pots 879 - 881 Plain fine ware beakers

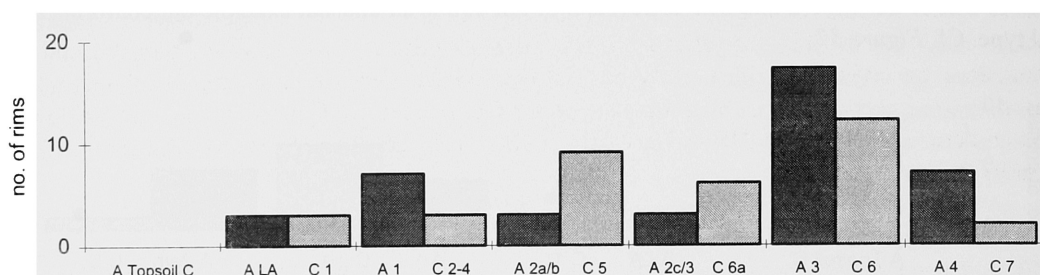

Figure 40 Plate 79 Pots 890 - 898 Painted fine ware beakers

Plate 84 Jars – Islamic, Parthian and Sassanian

All the jars illustrated here, except Pots 972-974 which were found on Site D and may be 12th-13th century AD, are from a single pit on Site A, tentatively ascribed to Parthian or Sassanian levels which are not represented elsewhere at Tell al Rimah.

Plate 85 Jars

Most of these jars were used as burial jars for children or infants, and are of Middle Assyrian date. Pot 985 has been included with these later jars because of the unusual feature of its pointed base. The rim, however, is characteristic of Old Babylonian Palace levels on Site C, and must not be confused with the similar rim of the much later Pot 969.

Plates 86 – 87 – 88 – 89 Jars

Pots 1018-1025 show many typical features of Old Babylonian jars:- horizontal grooves and combing and ineffectual ring bases, while Pots 1028-1032 are examples of an extremely common Late Old Babylonian small jar. Pot 1036 is the subject of an article by J. N. Postgate in *Iraq* 40, 71-75.

Plate 90 Jars – Khabur ware

Although many of the complete vessels or profiles illustrated here come from one location, adjacent to the walls of the Old Babylonian Palace Site C Level 6, and are associated with the “wine tablets”, these jars are extremely common and are largely confined to Old Babylonian levels. The graph illustrates the number of batches in which one or more sherds were found. The painted patterns are usually plain horizontal bands, the ware usually sandy in texture with little or no chaff temper. The method of manufacture seems to have been a combination of handbuilding and wheel-throwing. The lower part of the jar was drawn up from a large lump of clay resting on a rounded form, possibly a potsherd, which supported the base and enabled the pot to be turned slowly during manufacture. The interior surface of the jar was smoothed and thinned by scraping in a criss-cross pattern, a feature exclusive to these painted jars (and Pot 1064), thus making identification of unpainted bodysherds possible. There are traces of fine string impressions at intervals on the outside surface of the jars which would seem to indicate that string was used to bind the pot during construction. Above the carination, the shoulder and rim were finished on the wheel. Pot 1052 is the earliest example of a jar of this type, with incised patterns anticipating the painted versions. Cf. *Figure 41*.

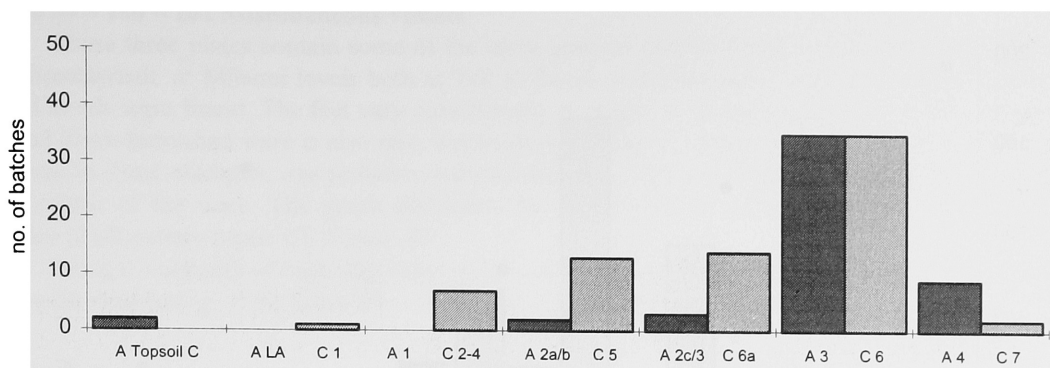

Figure 41 Plate 90 Khabur ware jars

Plate 91 Nuzi and Khabur ware jars and bowls

This plate consists of a selection of rimsherds and profiles of painted jars and bowls from different levels. Pots 1053-1054 are unusual handled jars from Site A Level 1, while Pots 1055 and 1060 are decorated in the style of Nuzi ware; the birds of Pot 1055 are very similar to those of Pot 675. Sherd 1059 is one of a very small number of examples of examples of bird decoration dated to the end of the Old Babylonian period (see also Pot 818 and 828). Such bird motifs are characteristic of Mitanni levels both at Tell al Rimah and Tell Brak.

Plate 92 Strainers

All the complete strainers and profiles found are illustrated here, with the latest examples on the top left of the page and the earliest on the bottom right. Strainers are found in all levels and except for Pots 1074 and 1092 are all small. The strainers from earlier levels are generally better finished than the later examples and their shapes closely echo those of similar-sized ordinary bowls of the same date. Cf. Figure 42.

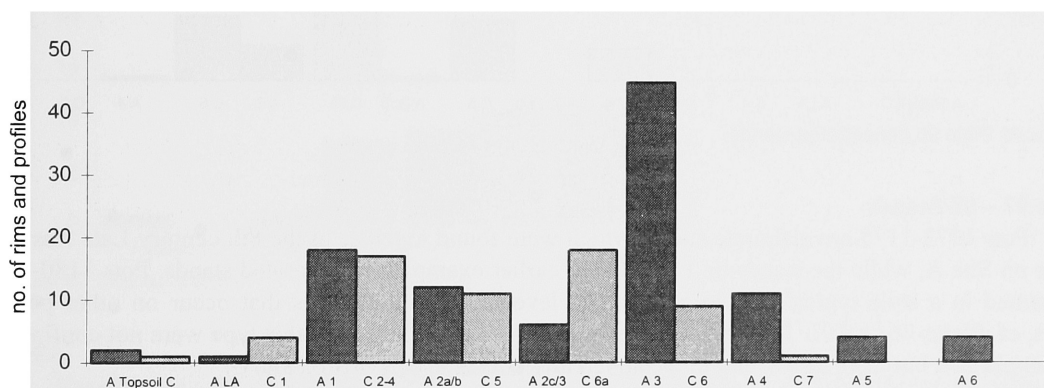

Figure 42 Plate 92 Strainers

Plates 93 – 94 Potstands

The “pie-crust” potstand is the most common type of Mitanni potstand. Most of the examples found come from Site C Levels 4 and 5 and Site D Level 4, but there are some examples from earlier levels (Pots 1119, 1129, 1134). A few have been found *in situ*, showing that they were used with “pie-crust” rim down. The upper rims are often coated with a bitumen wash. Cf. Figure 43.

Plate 95 Potstands

The Late Assyrian potstands, Pots 1135-1139, have some parallels at Nimrud Fort Shalmaneser. Pots 1149 and 1150 are unusual examples of elaborate stands of a type characteristic of the Mitanni Palace at Brak – most stands found at Tell al Rimah are plain with very little decoration. Pot 1156, from the Late Old Babylonian “kitchen”, is a slightly more elegant example of the type illustrated on Plate 96. Pots 1160-1164 are small or miniature potstands from various levels.

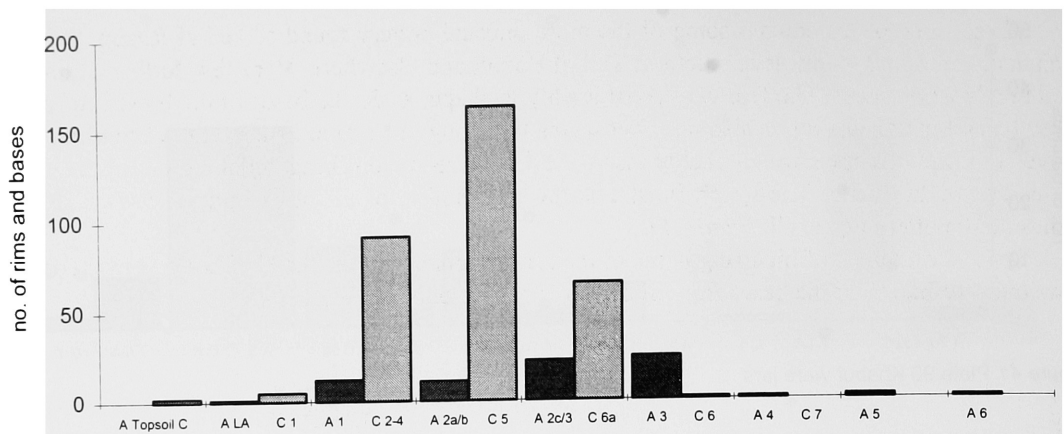

Figure 43 Plate 93 - 94 'Pie-crust' potstands

Plate 96 Fenestrated stands – Old Babylonian

Stands with three triangular or oblong holes in the sides and sometimes a round hole in the centre of the base are commonly found in Old Babylonian and Late Old Babylonian levels, more frequently on Site C. Cf. Figure 44.

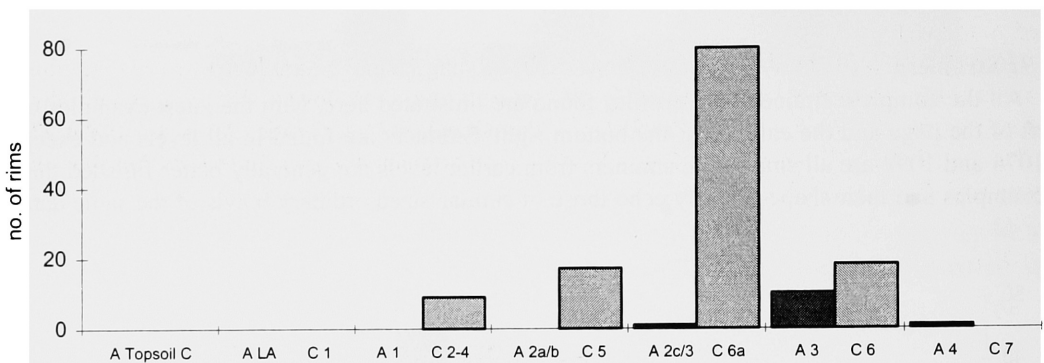

Figure 44 Plate 96 Fenestrated stands

Plates 97 – 98 Stands

Pots 1173-1175 are elaborate stands which were found together in the 8th century Late Assyrian Shrine on Site A, while the stands on Plate 98 are earlier examples of decorated stands. Pots 1180-1182 are painted in a style typical of Old Babylonian levels and with patterns that occur on other pottery shapes, cf. Plates 76 and 91. It is perhaps interesting to note that stands of this type were not confined to the Temple site, but were also found in the apparently domestic contexts of Site C.

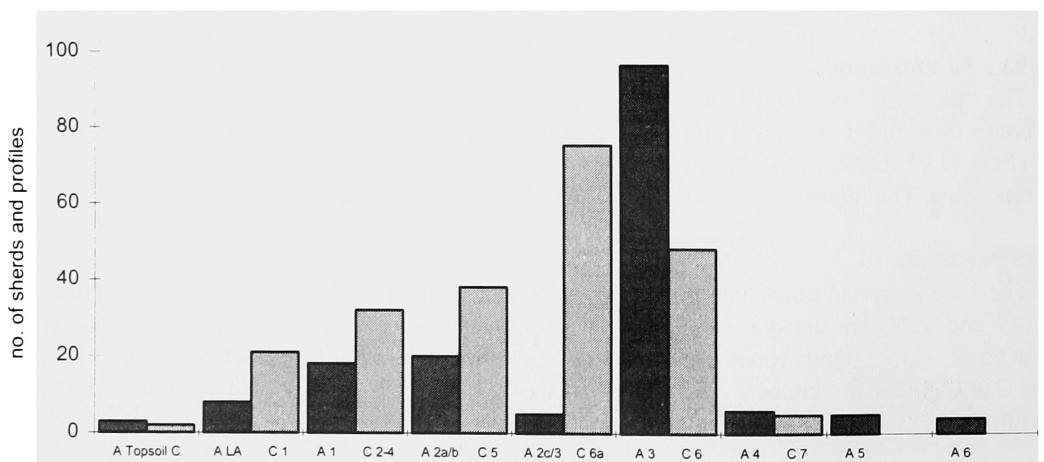

Figure 45 Black and grey ware sherds

Plates 99 – 100 – 101 Miscellaneous vessels

These three plates contain some of the more unusual pottery found at Tell al Rimah. “Pig pots” are characteristic of Mitanni levels both at Tell al Rimah and elsewhere. Very few further examples of tripod bowls were found. The feet vary considerably in shape, as do the bases of the bowls. Stamped or incised black burnished ware is also rare, but seems to belong in Mitanni levels. The white filling which survives in some examples was probably inserted after the reduction firing which produced the black or grey colour of the ware. The graph illustrates the distribution of all black and grey ware sherds or profiles of all pottery types. Cf. *Figure 45*.

Several examples of high ring bases of the same general type as Pot 1218 were found. The graph shows the distribution of the bases from Site C 1971 season only. Cf. *Figure 46*.

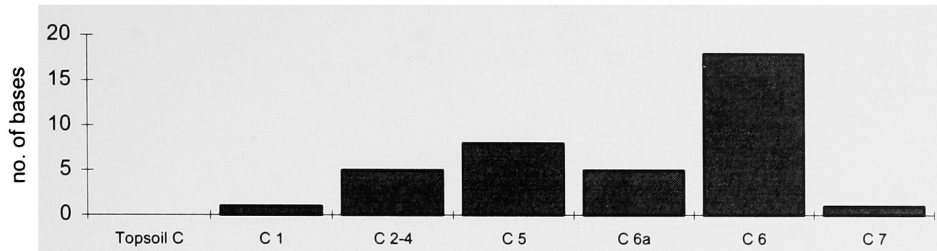

Figure 46 Plate 100 Pot 1218 Fine ware high ring bases

Glazed pottery

Very few glazed sherds were found, the earliest being from Mitanni levels associated with finds of glass vessels. Illustrated examples of glazed vessels are as follows:– Pot 151: bowl; Pot 920: miniature jar; Pot 921: miniature jar; Pot 922: miniature bowl; Pot 925: bottle; Pot 948: jar; Pot 974: jar; Pot 1221: jug; Pot 1227: lamp; Plate 25f: TR 4313 compartmented vessel, Late Assyrian Shrine; Plate 19e: jar sherd. Cf. *Figure 47*.

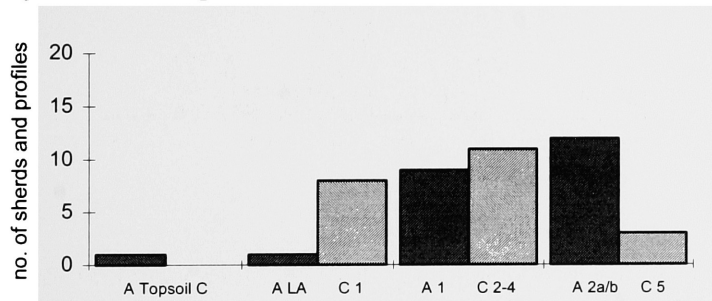

Figure 47 Glazed sherds

Handles

Handles were not commonly found at Tell al Rimah, but it may be of some interest to include this graph of examples of strap handles. Lug handles also occur, either on Late Assyrian cooking vessels or on Old Babylonian or earlier cooking vessels and bowls, but were not found at all in Middle Assyrian and Mitanni levels. Cf. *Figure 48*.

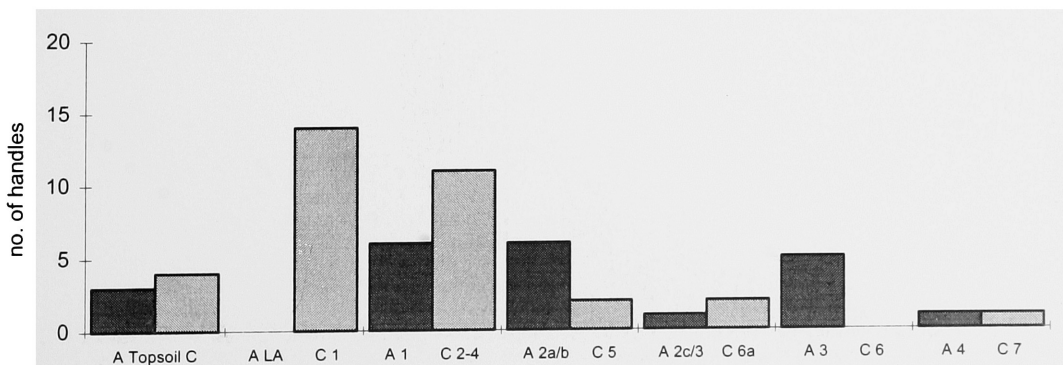

Figure 48 Strap handles

THE PLATES

PLATE 1



a) Tell al Rimah from the south

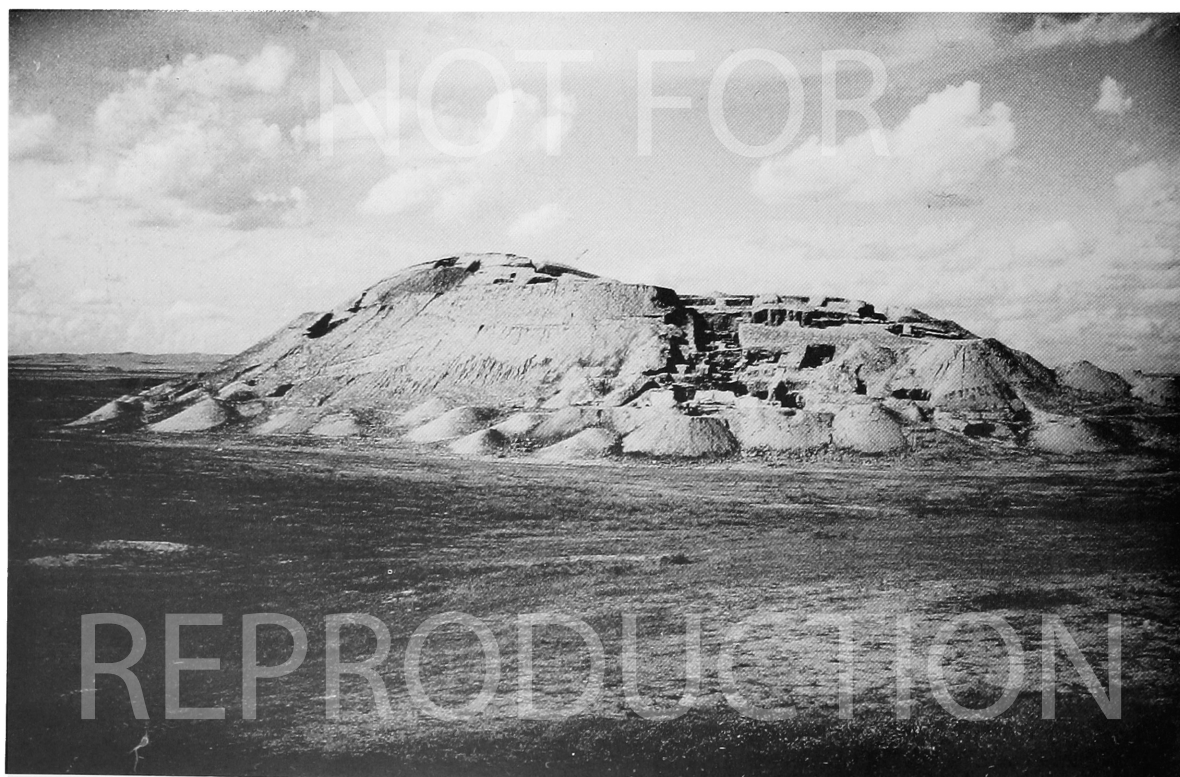

b) Central tell: Site A and Area AS (1968)

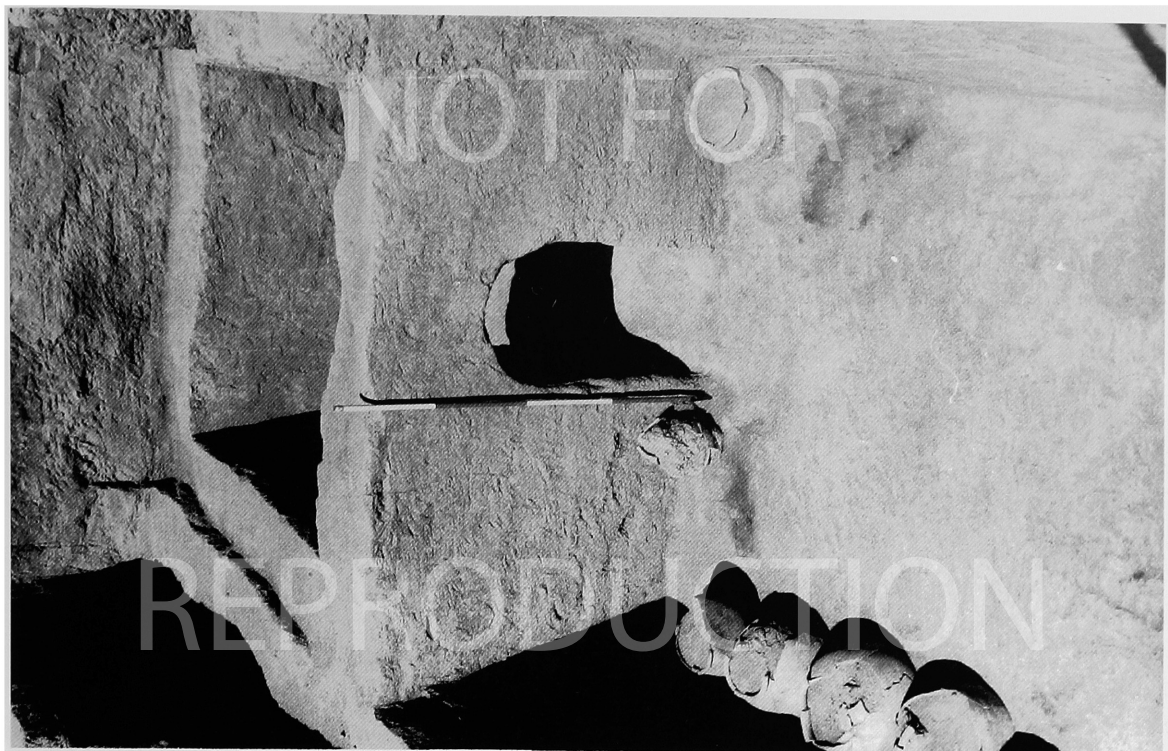

c) Storage magazine: Temple Room 47, a Late Level 3 subdivision of Room XVII (A463)

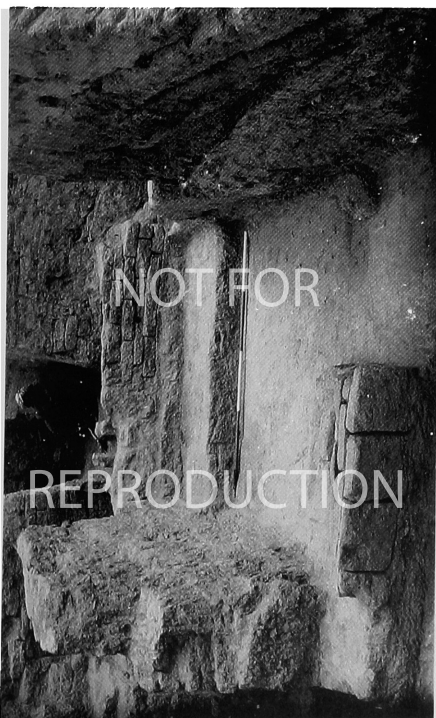

a) Great Temple: Level 2 Room 5 in which large quantities of frit and glass were found

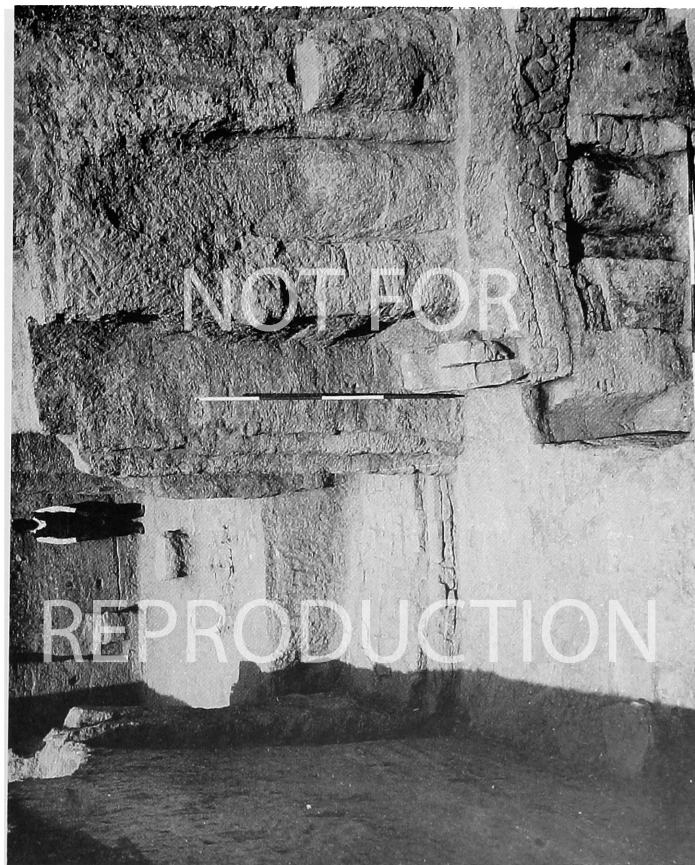

b) Entrance to the Temple antechamber. The figure stands on the floor of Level 1, the vertical staff on the courtyard surface of Level 2 and the horizontal staff on the uppermost floor of Level 3

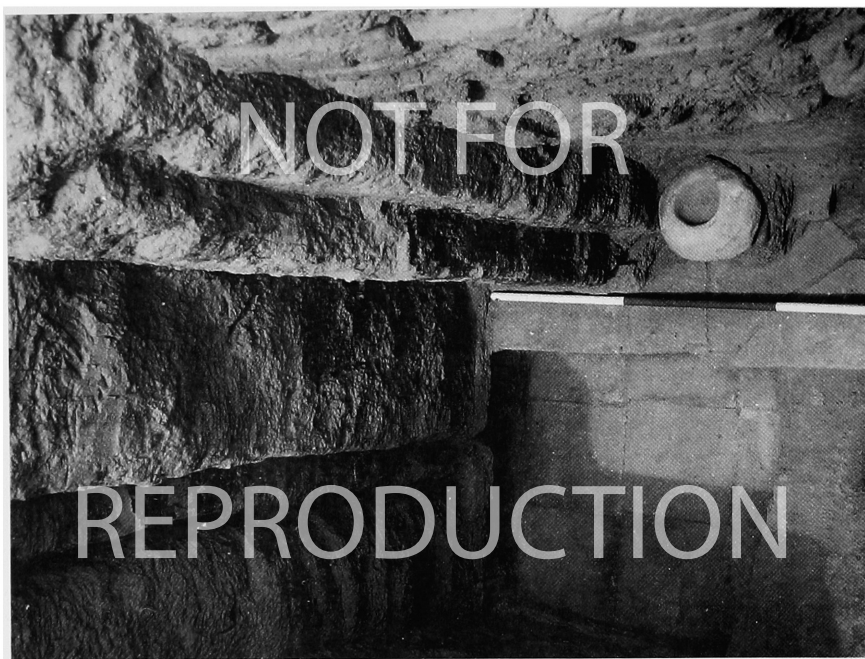

b) Great Temple: succession of Level 3 pavements, the latest represented by the door socket

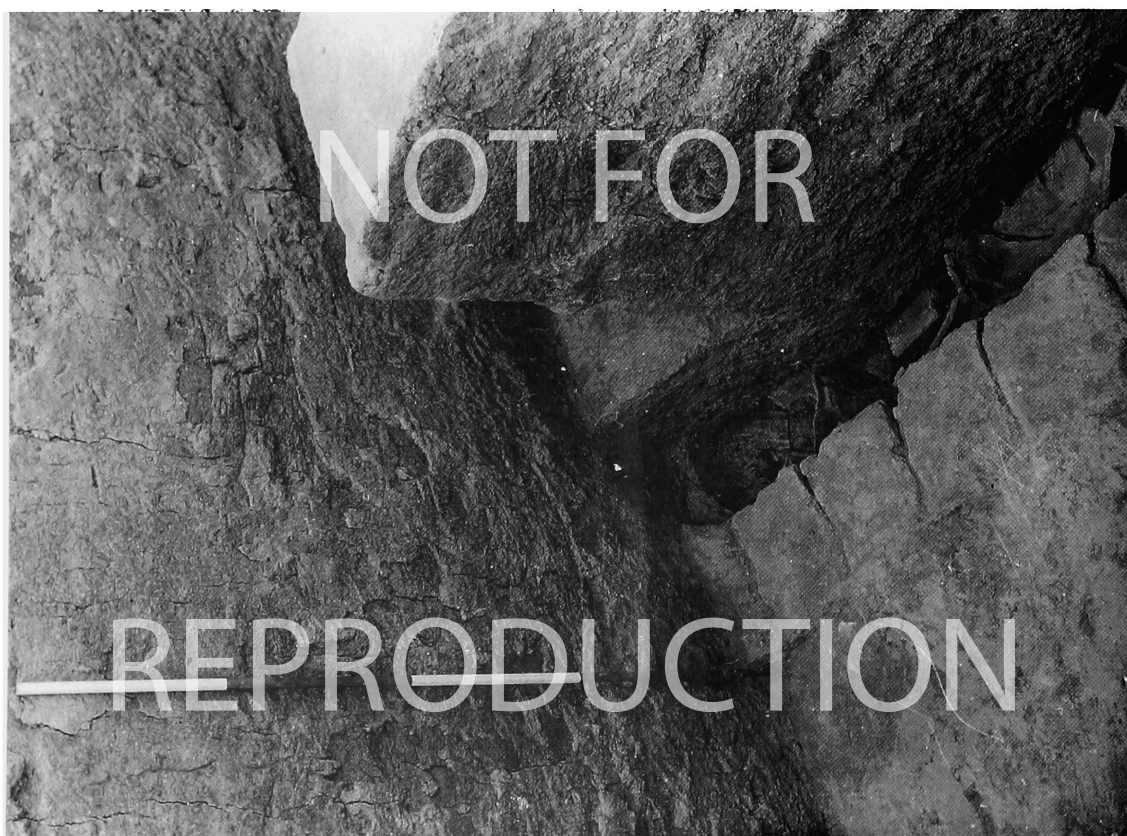

a) Great Temple: Room II showing destruction level pottery (A.565) overlaid by a Late Level 3 wall

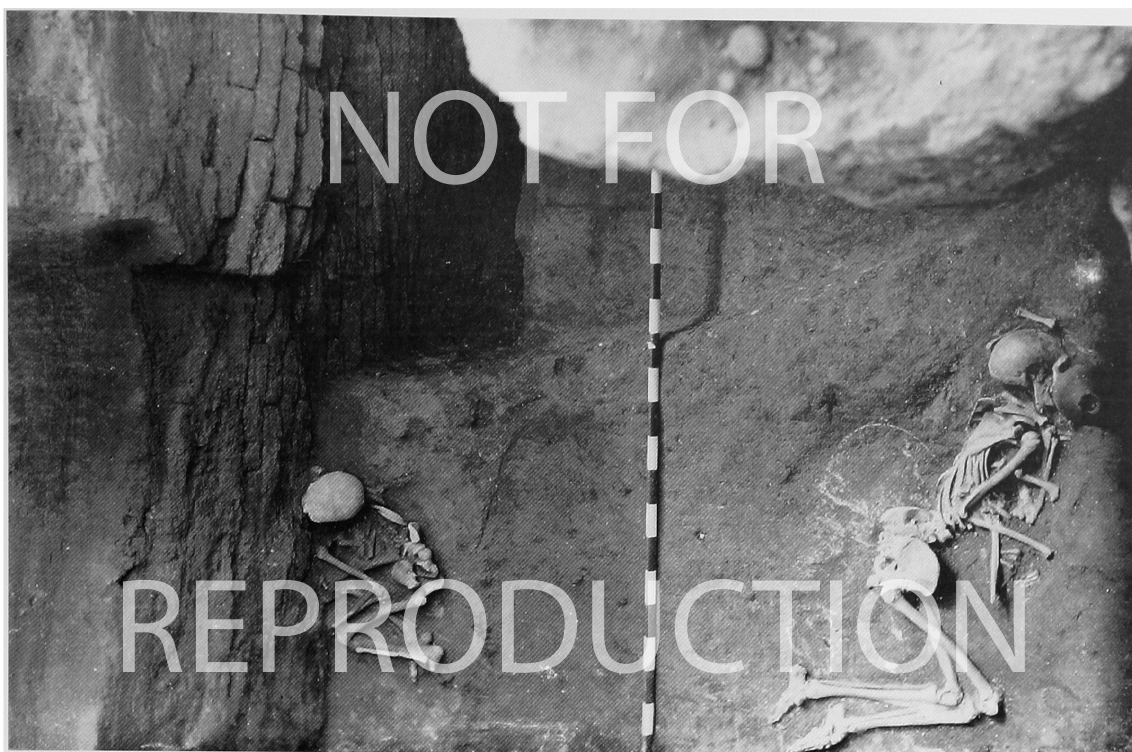

b) Area AS showing third millennium graves AG 2-68 and AG 3-68 with jar 547 in situ (p. 27)

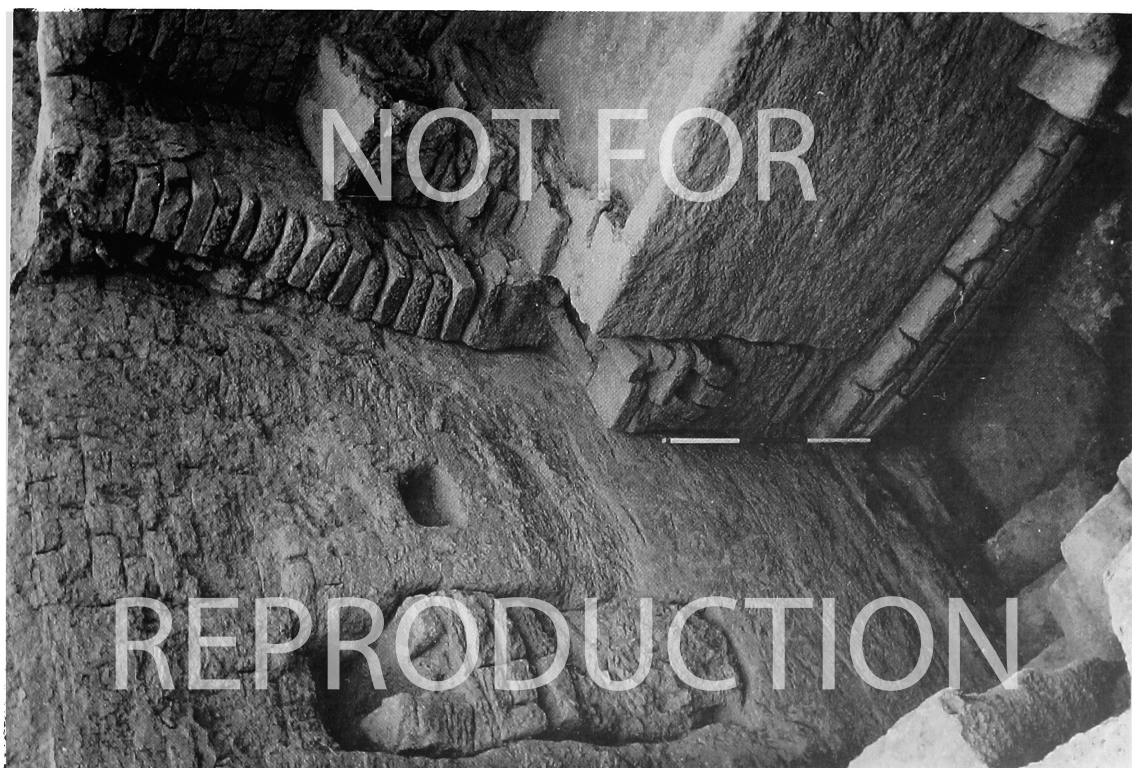

a) Great Temple: Room III from the southwest, showing successive mud-brick pavements overlaid by a Level 3 reinforcing wall, with Level 2b brickwork above

PLATE 5

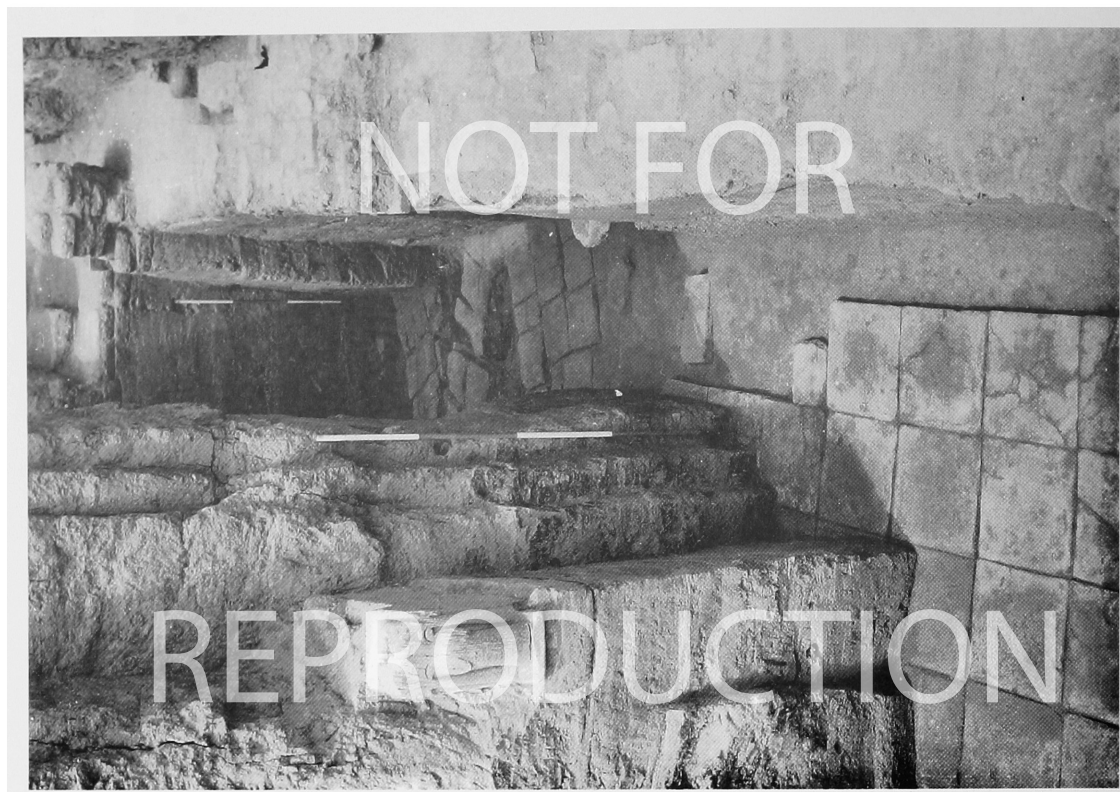

b) Detail of the antecella doorway showing the second Level 3 courtyard pavement in the foreground and, within the antecella, earlier walls below the earliest Temple floor. The Lama impost block rests in a secondary position just above the Level 2c floor

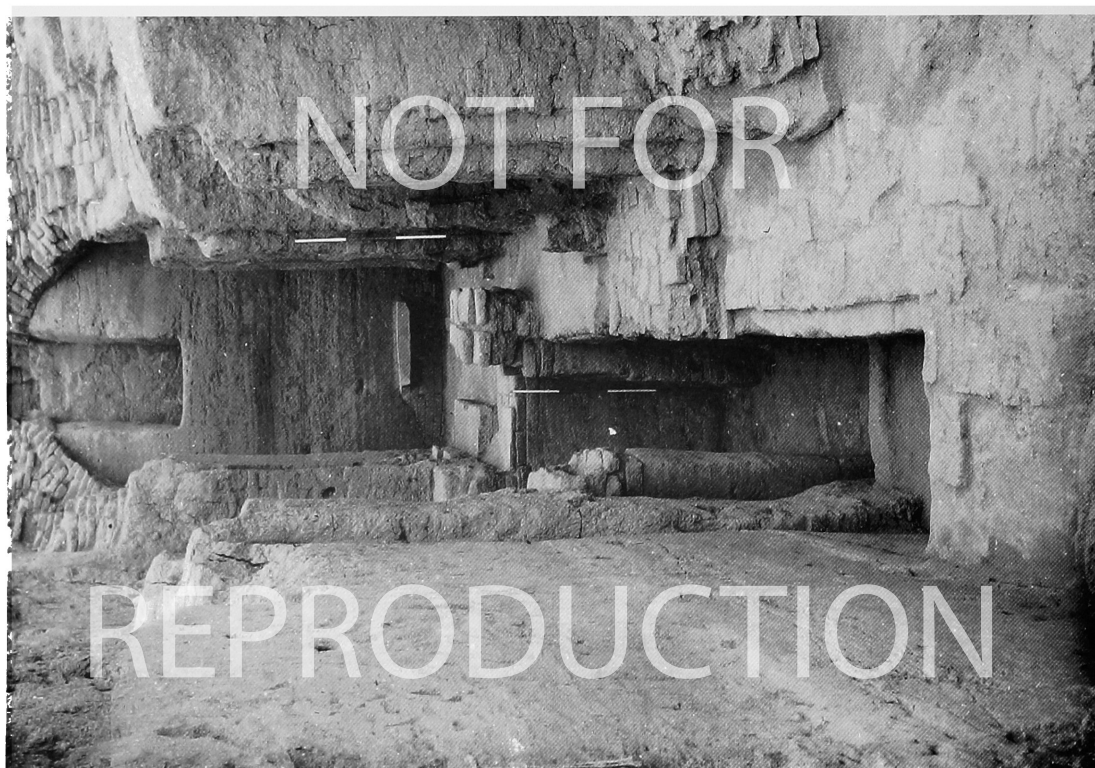

a) Great Temple: view from the east through the antecella and the cella doorways. The upper pole rests on the Level 2b floor, the lower on an early Level 3 floor



b) Impost block, found in a secondary position at the left of the entrance to the Great Temple antechamber. It bears an Old Babylonian dedicatory inscription (cf Iraq 1967, 74-6). Height of block 58cm

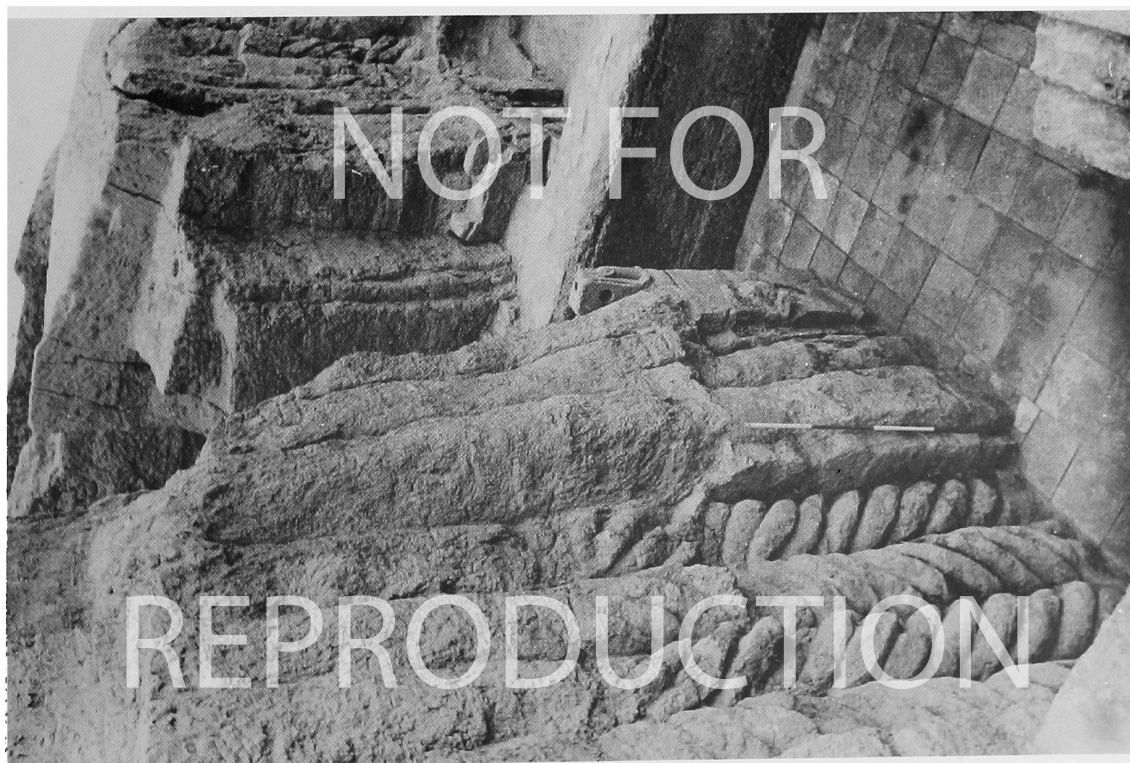

a) The east façade of the Great Temple courtyard, showing Level 3 spiral columns and the Lama and Humbaba impost blocks resting just above the Level 2c floor



b) The second Humbaba impost block, which washed out of the east gate chamber during the winter storms of 1970-71; possibly of Mitanni date (Mosul Museum)

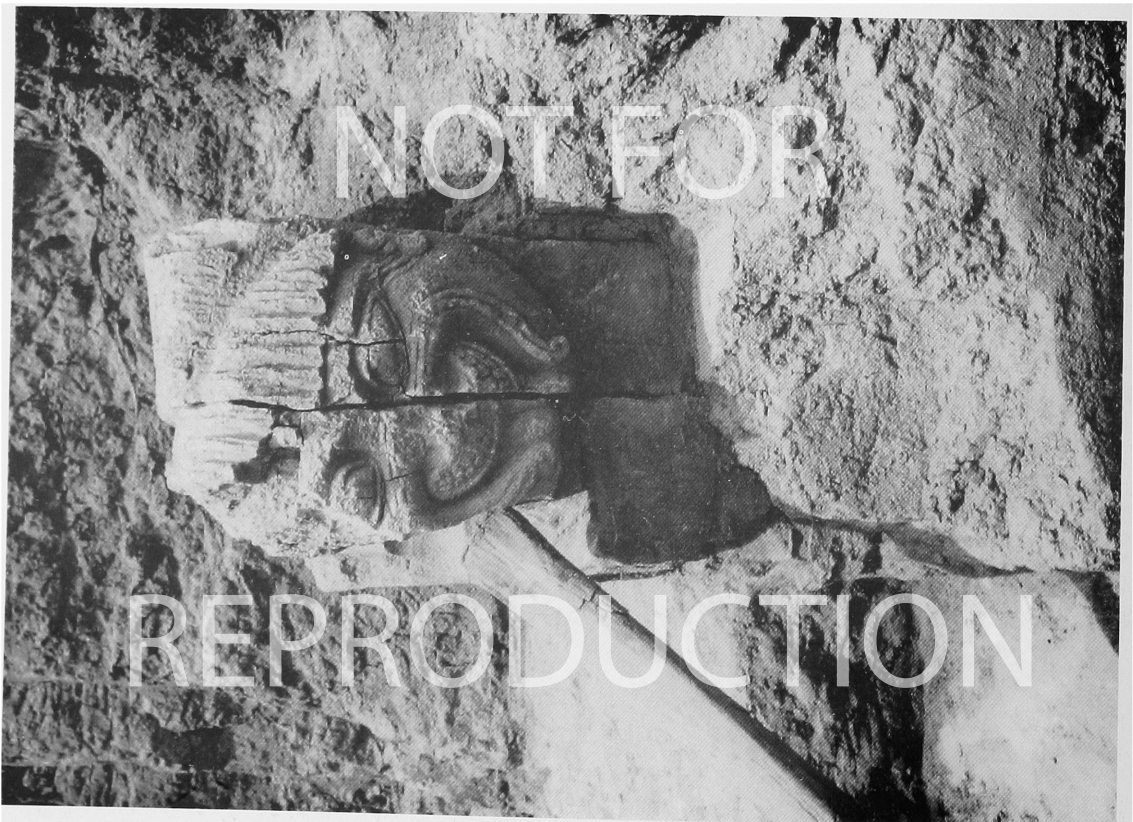

a) The Humbaba impost block, presumably of Old Babylonian date, found on the right of the entrance to the Great Temple antechamber, resting on the Level 2c floor

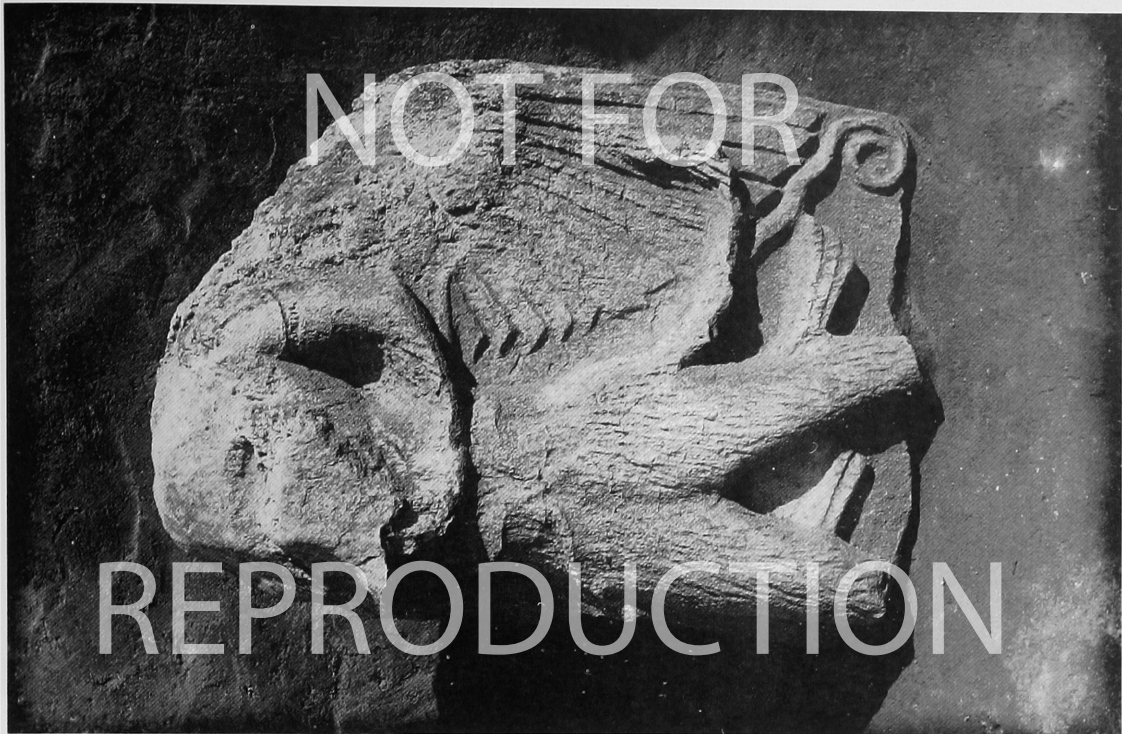

b) Scorpion-man orthostat from the Great Temple, Mosul marble.
Height 80 cm (p.26)

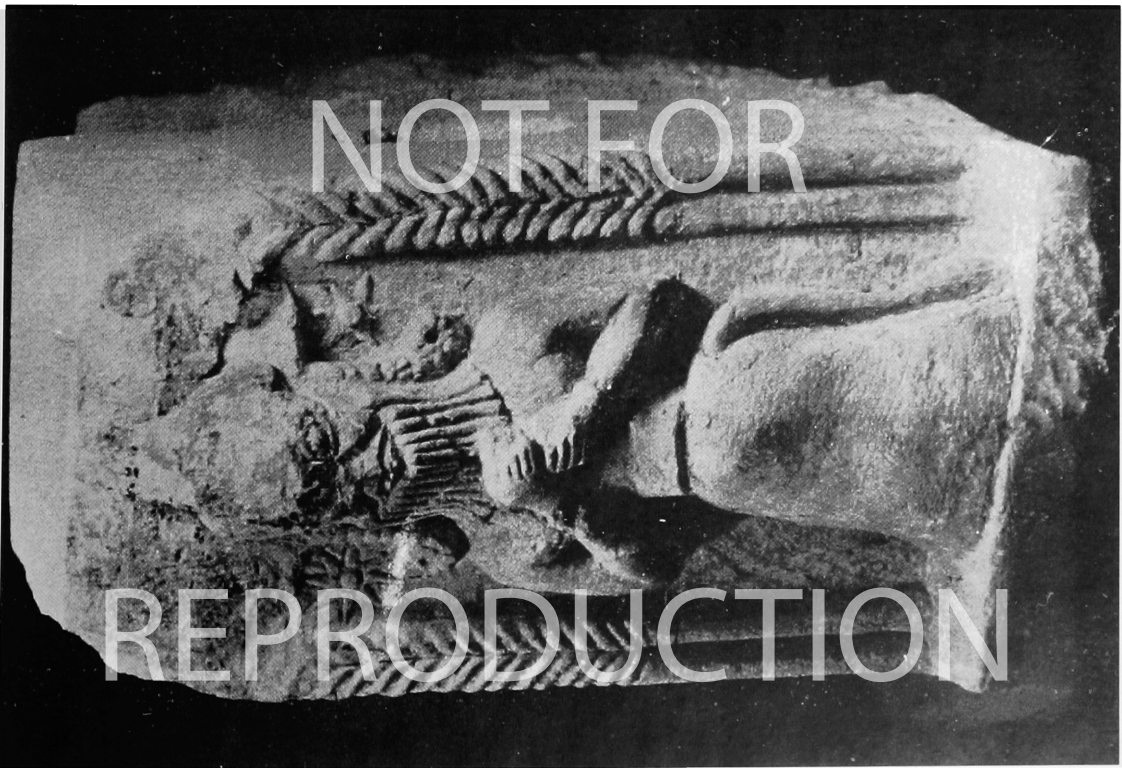

a) Bull-man impost block, the companion piece to Humbaba 2, Plate 7b,
also from the east gate chamber (Mosul Museum)

PLATE 9



a) Side view of Humbaba 2 impost block (Plate 7b)

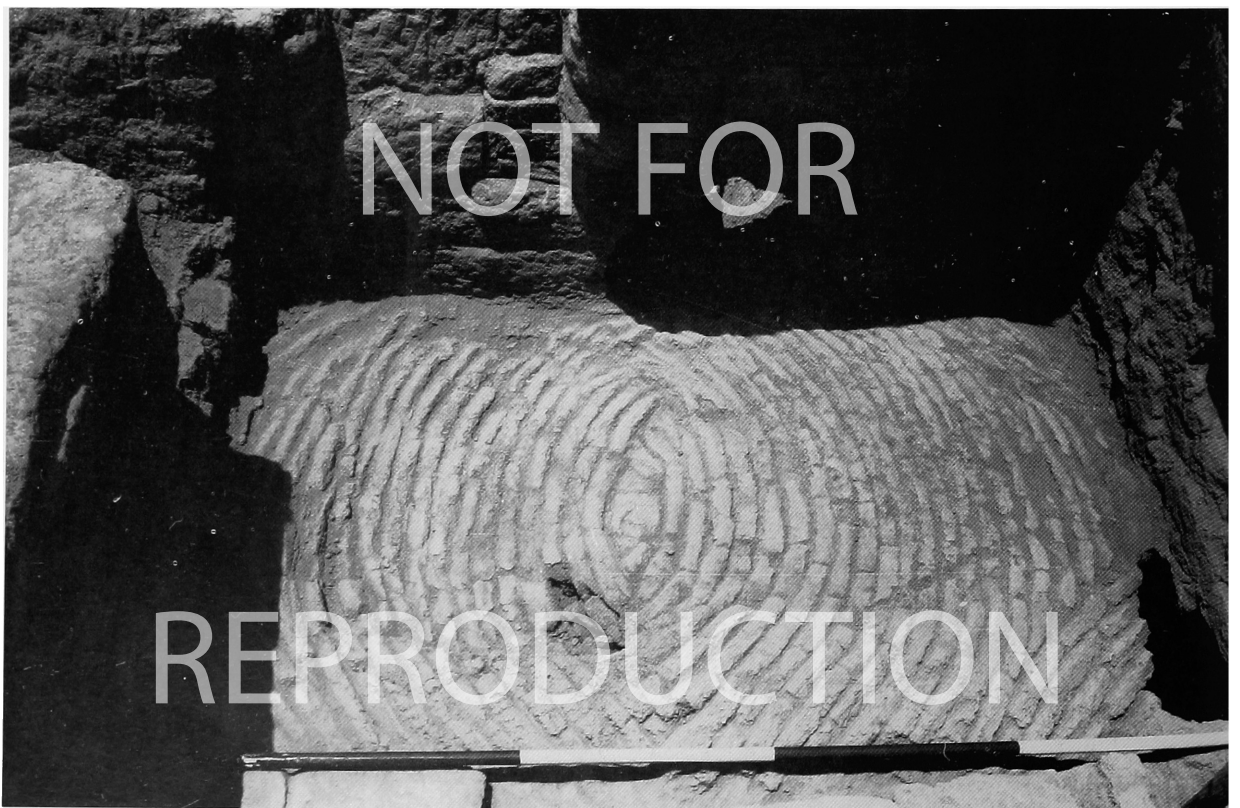

b) Area AS, detail of third millennium BC domical vault

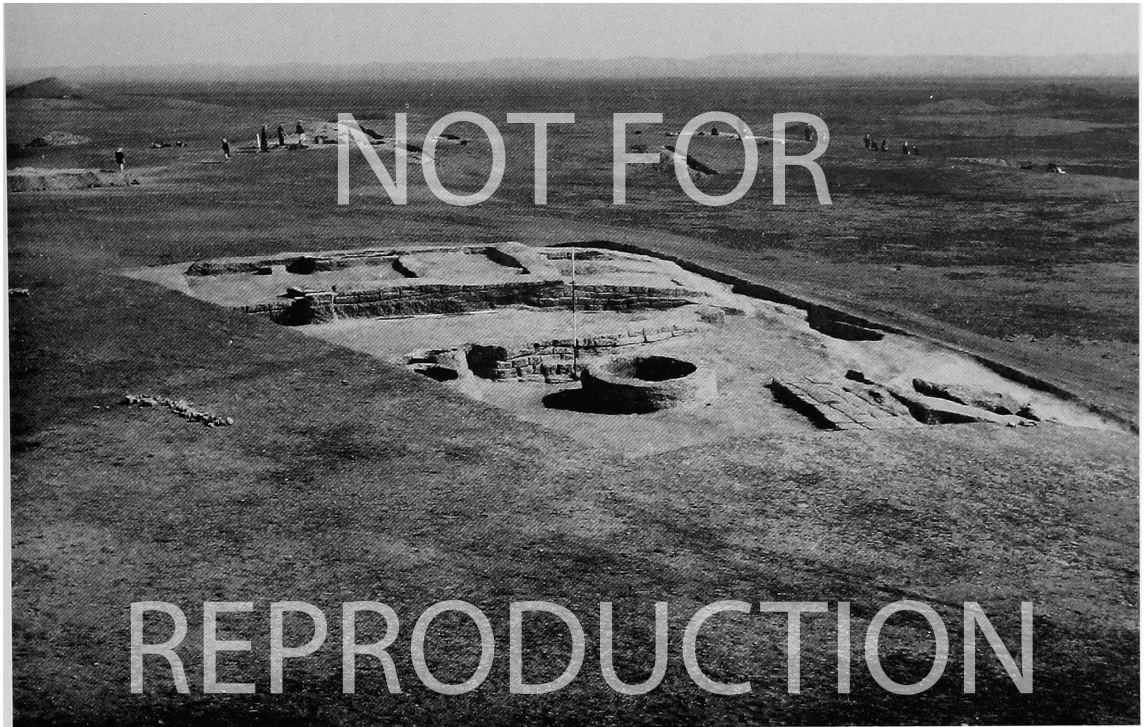

a) View of Site B with Site C in the background, 1964

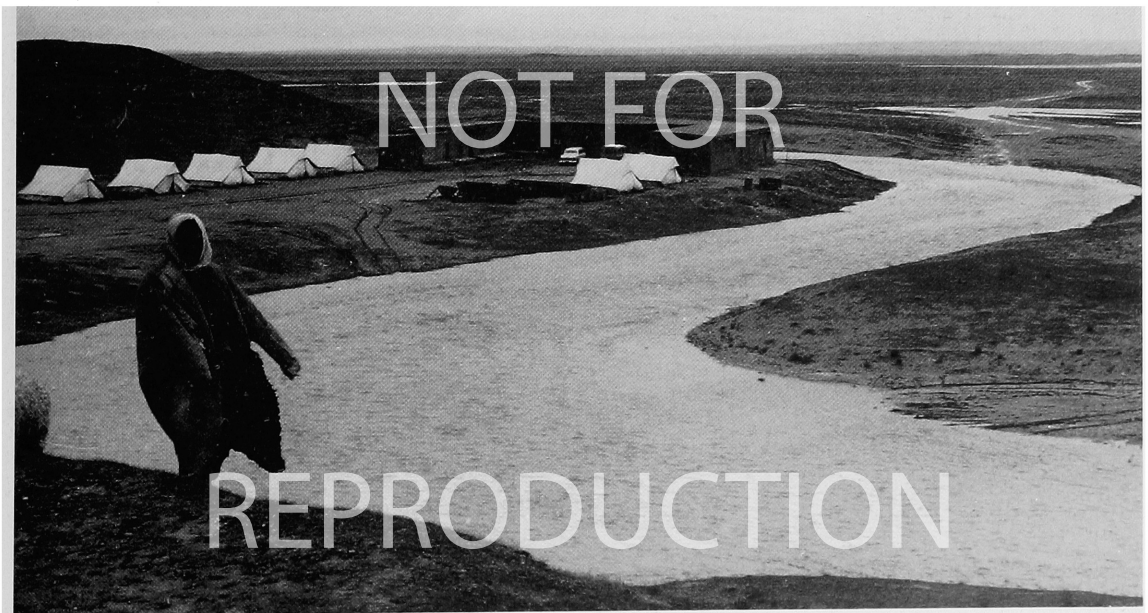

b) The Rimah wadi in spate, outside the northeast town wall, April 1971

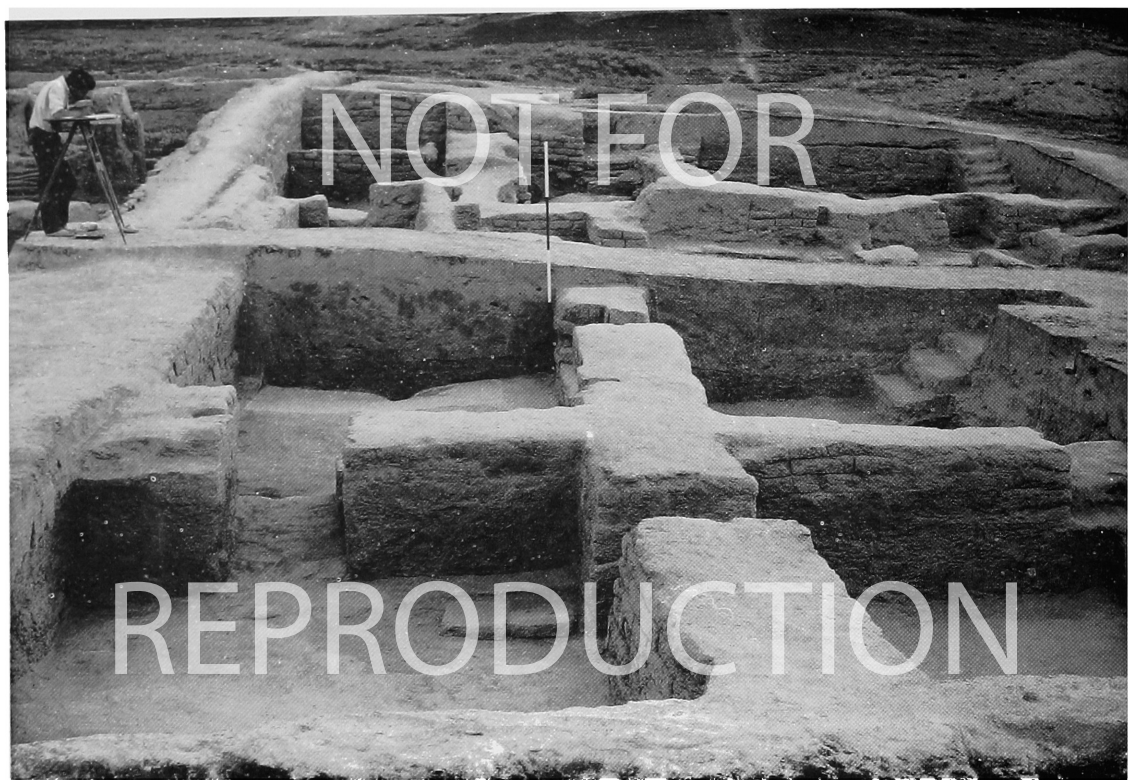

a) Site C Late Assyrian houses, 1968



b) Site C Small Middle Assyrian shrine, 1968

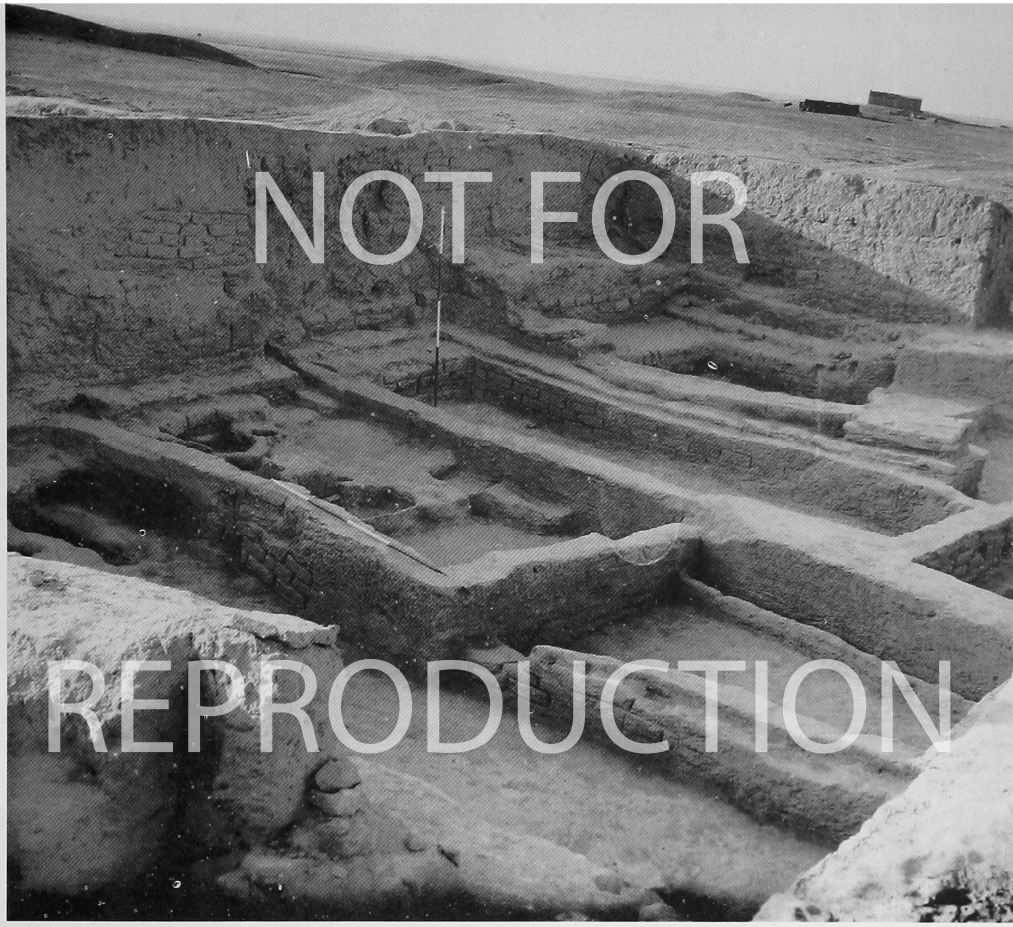

a) Site C Mitanni Rooms 55-59 from the southeast, 1967

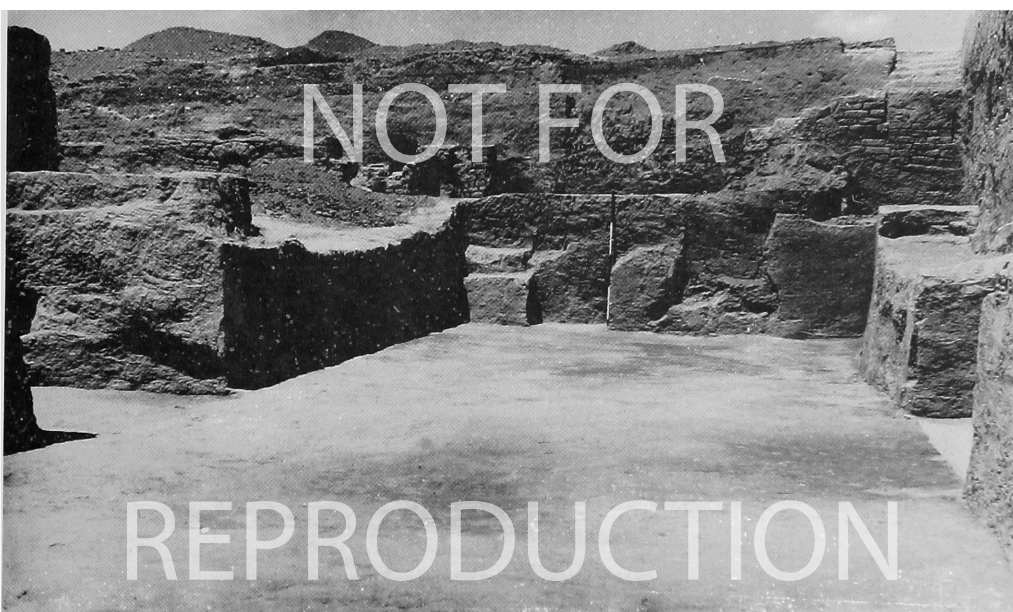

b) Site C Level 6 Palace antechamber (Room XIV) from the west

PLATE 13

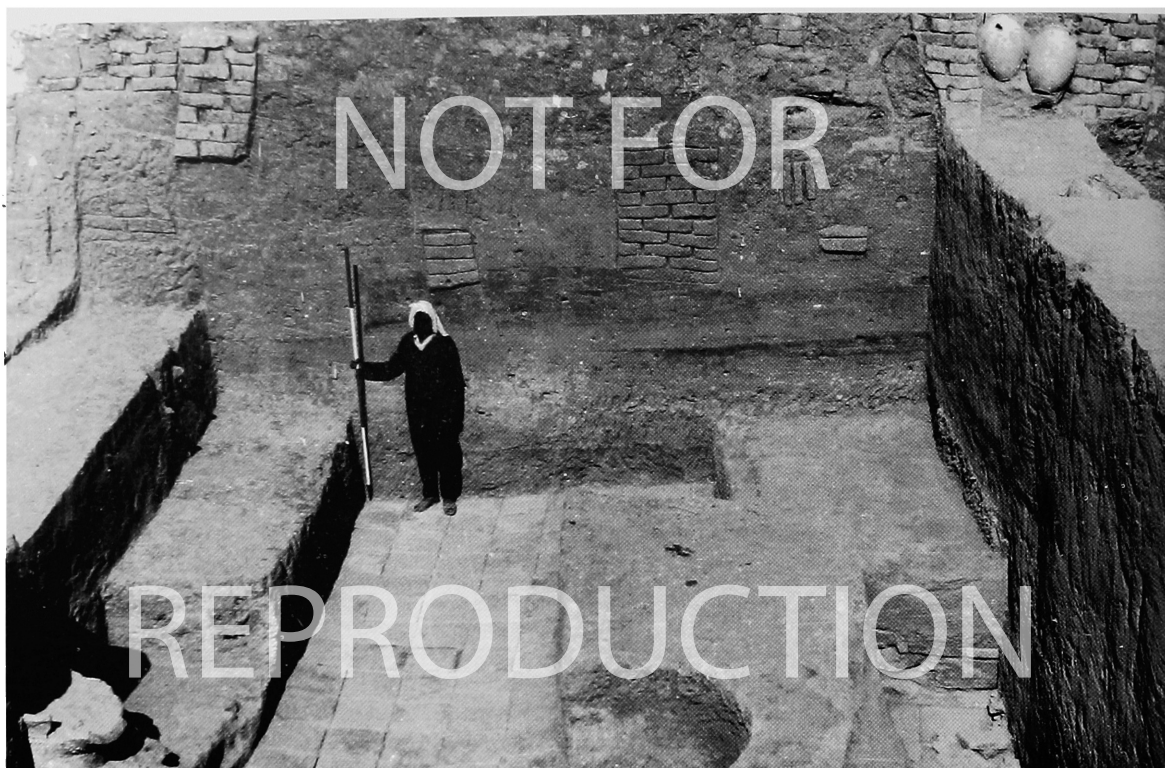

a) Site C west section, 1971. The figure stands on the Old Babylonian pavement of Passage XXI. The two jars are Middle Assyrian (991 and 997)

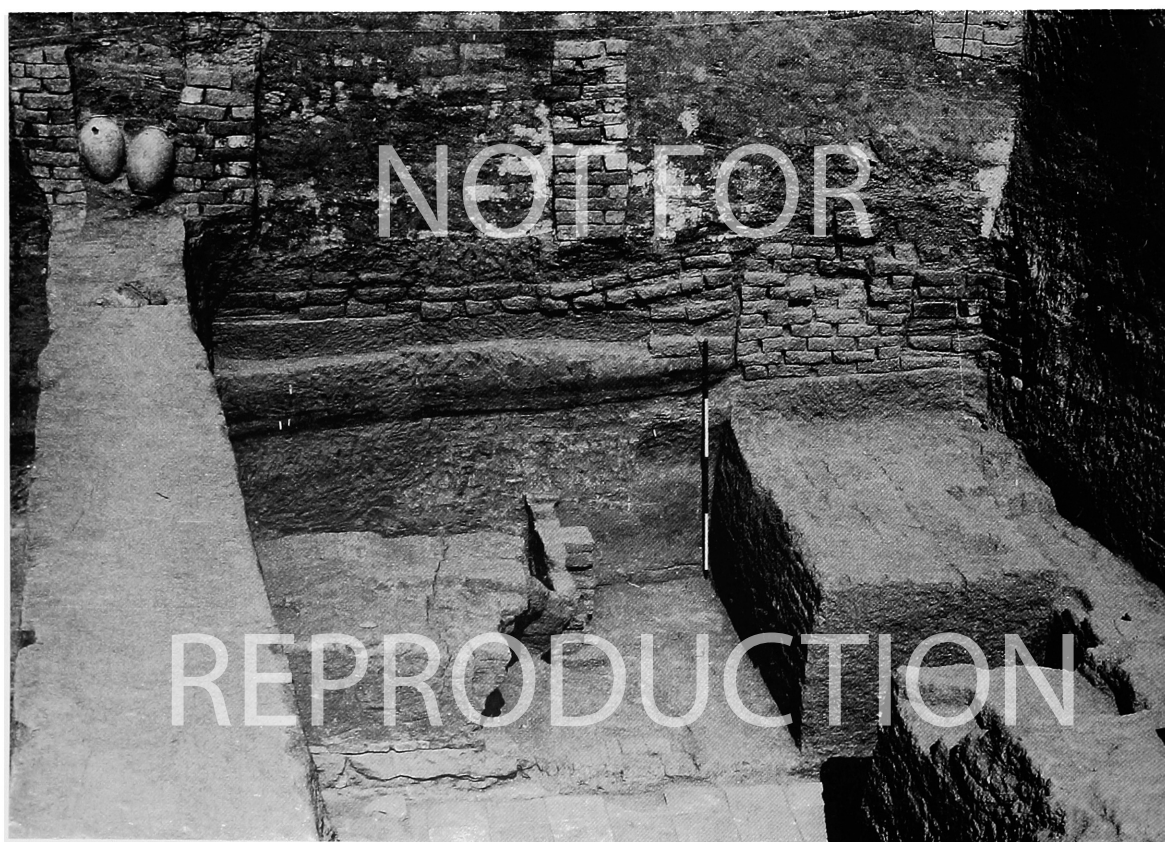

b) Site C west section, 1971. The pavement of Room XXIII can be seen in the foreground



b) View of the Late Assyrian shrine, showing how it was cut into the brickwork of the Old Babylonian ziggurat

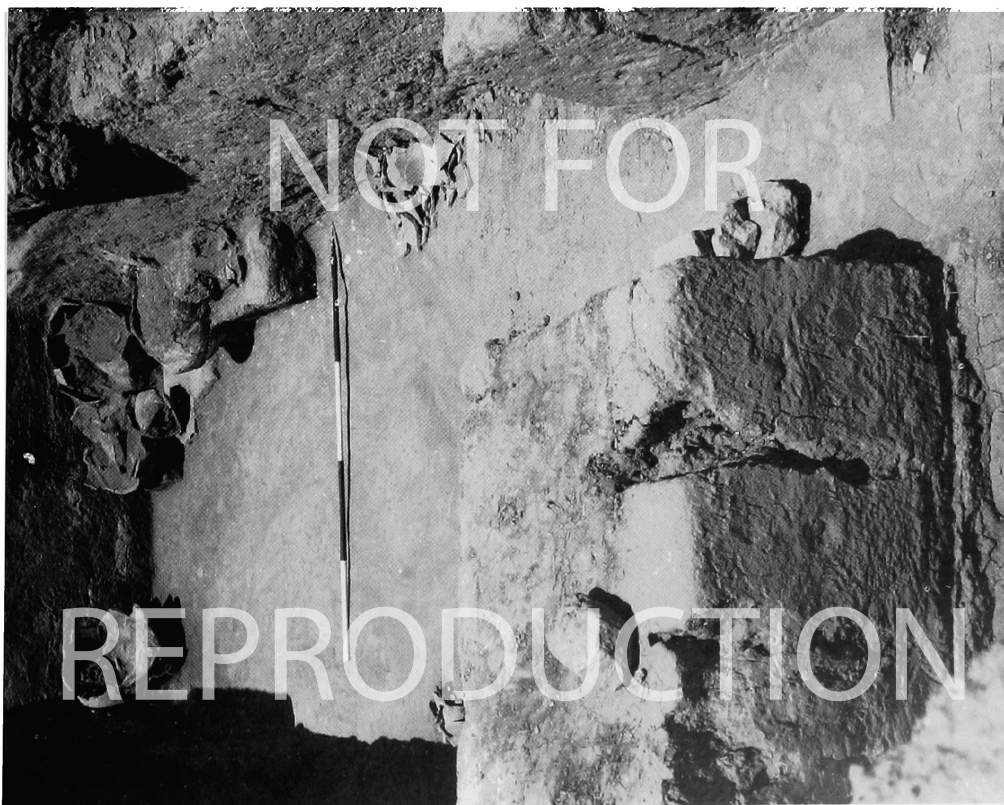

a) West end of Palace Room II in which tablets of Hatmu-rapi, contemporary with the reign of Zimri-Lim, were recovered (p. 30)

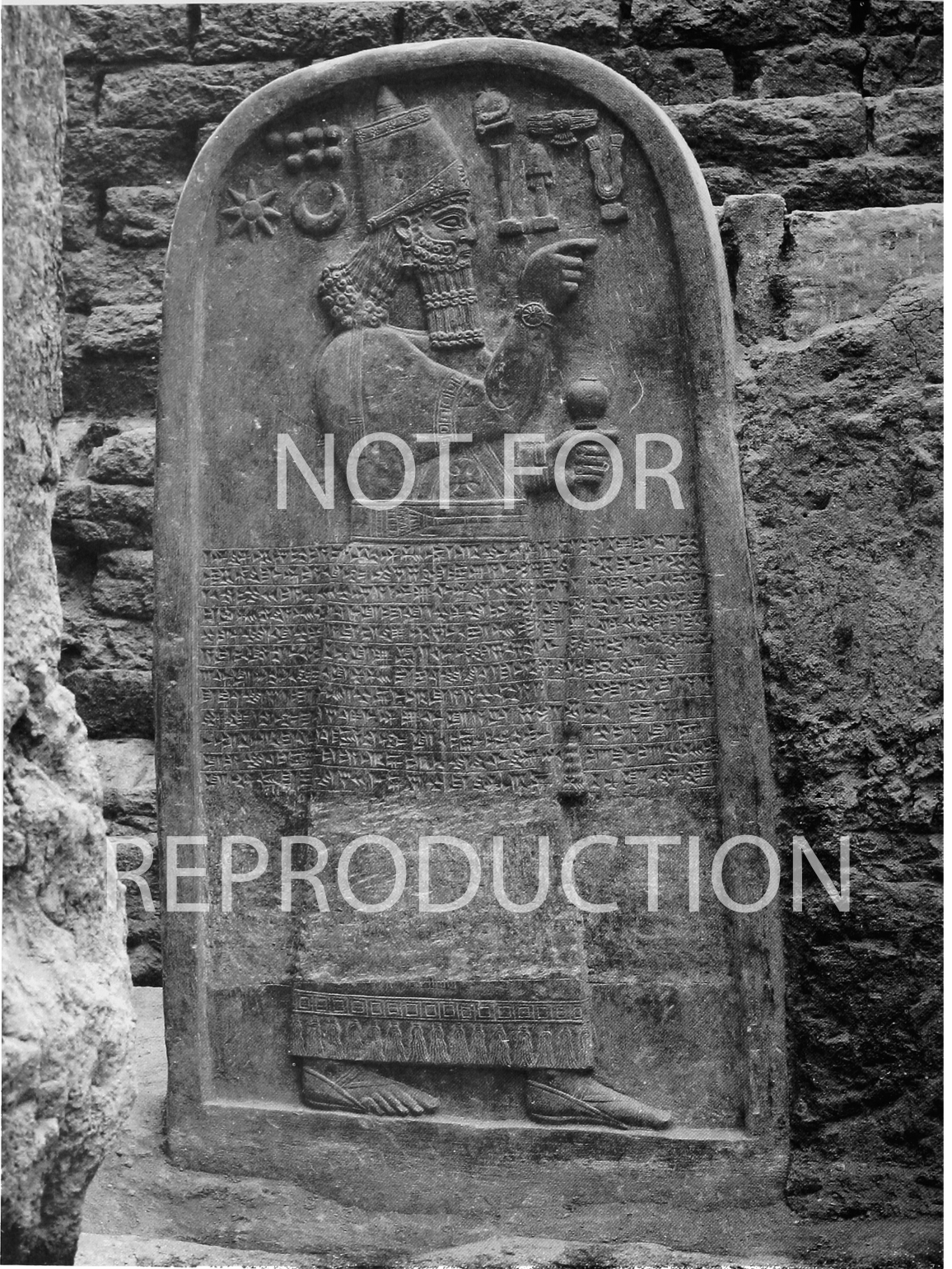

Stele dedicated to Adad-Nerari III by Nergal-Eresh, found in the cella of the Late Assyrian shrine

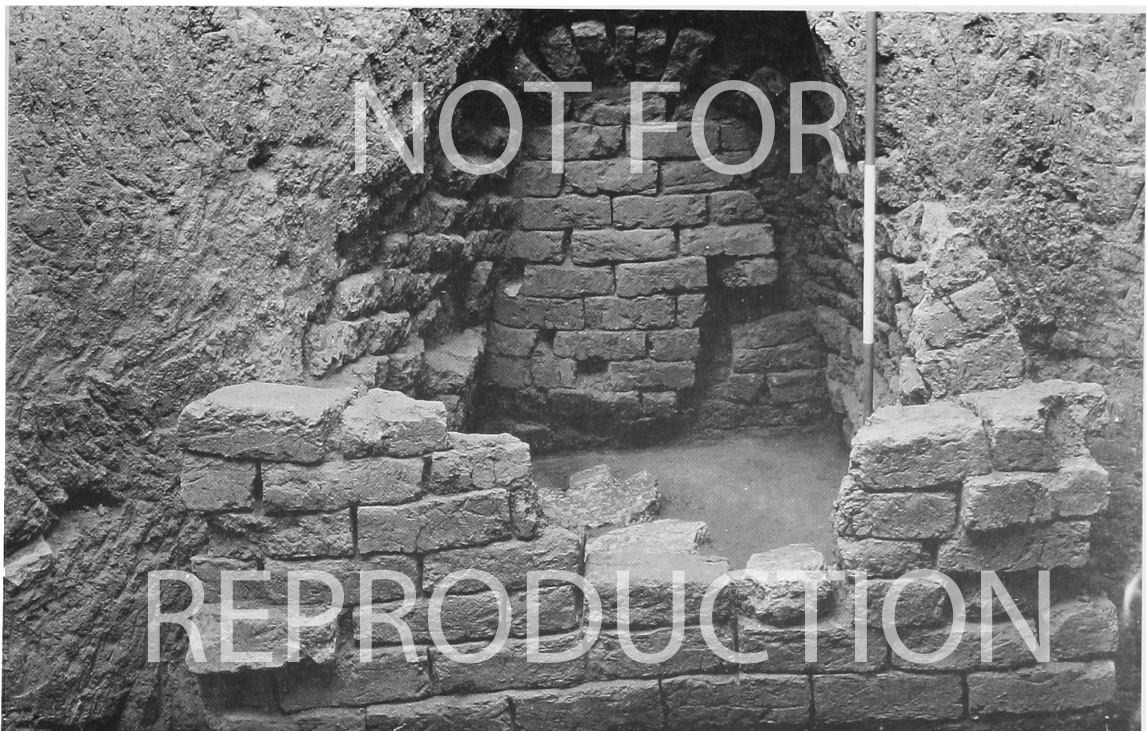
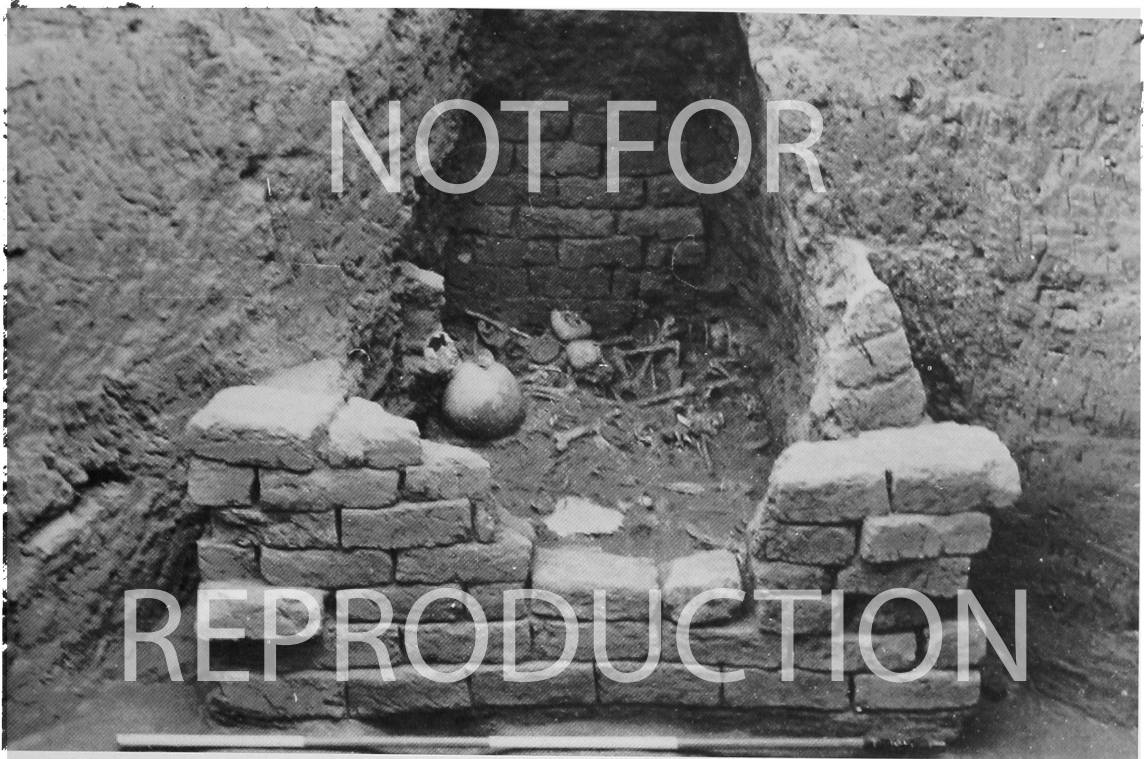

Site D Mitanni burial vault (DG 22-66), in which several bodies and many valuable objects were found

PLATE 17

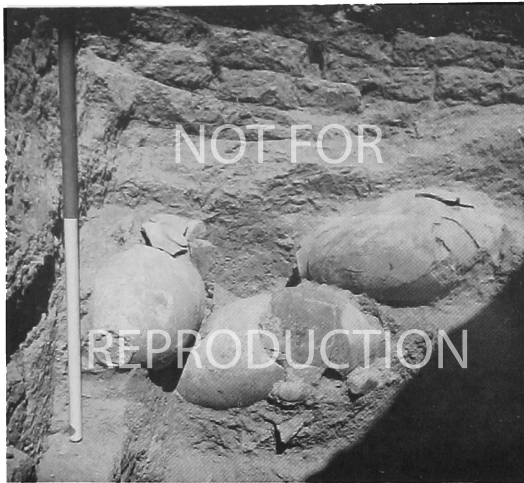

a) Graves DG 8a-66, 8b-66, 8c-66



b) Grave DG 8a-66, jar 979

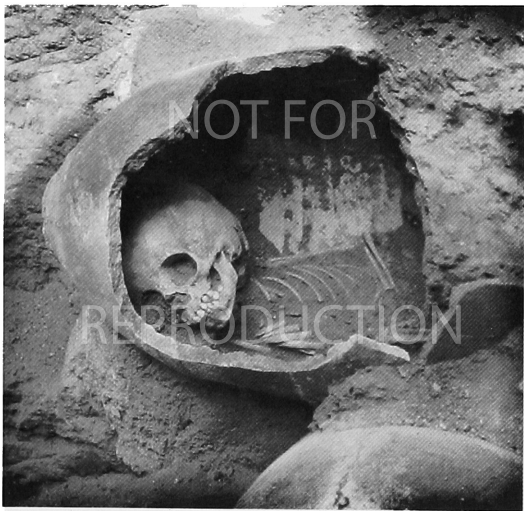

c) Grave DG 8b-66, jar 977

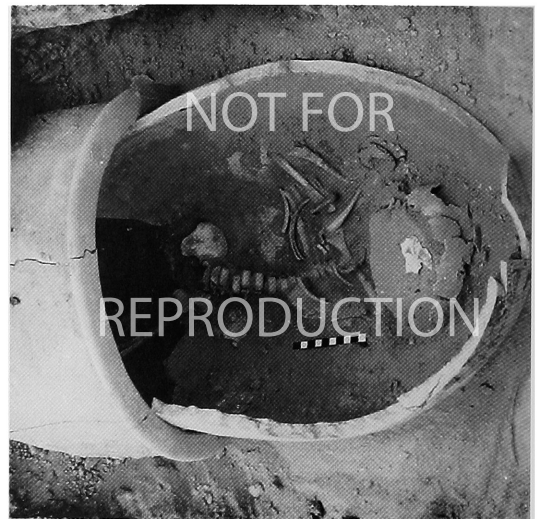

d) Grave DG 13-66, bowl 598



e) Grave DG 7-66, jar 945

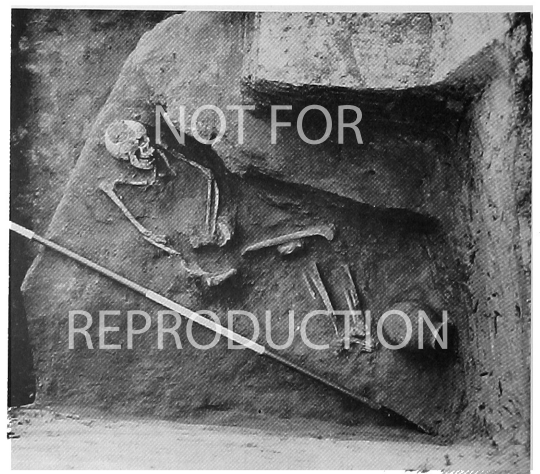

f) Grave DG 3-66, jar 949

Site D Late Assyrian graves



Late Assyrian grave CG 5-68, deep bowls 601-603

PLATE 19

KHABUR WARE, NUZI WARE AND LATE ASSYRIAN SHERDS

Photo	Batch No	Pot No	Level	Ware
19a	A 410	563	A 4	Ware: medium coarse buff. Temper: chaff. Paint: black to red bands and hatched triangles. Rim sherd.
	A 585 A 586	872	A 3 late	Ware: medium coarse buff. Temper: grit and chaff. Paint: red with widely-spaced strokes on rim. Rim sherd.
	A 402	559	A 3-4	Ware: medium coarse buff. Temper: white grit and chaff. Paint: brown. Horizontal grooves under painted pattern. Rim sherd.
	A 565	560	A 3	Ware: coarse buff. Temper: grit and chaff. Paint: dark red strokes on rim and splashes inside. Rim sherd.
	A 403		A 3-4	Temper: grit and chaff.
	A 439		A 3 late	Temper: grit and chaff.
	A 403	~875	A 3-4	Temper: grit and very little chaff.
	Unstratified			Temper: grit. Paint: underfired dark red. Deliberately cut disc.
19b	A 406, A 408, A 411	1062	A 2c-3	Ware: medium coarse buff. Temper: grit and chaff. Paint: red. Rim sherd.
	A 460	~890-892	A 4	Temper: fine grit.
	A 565		A 3	Temper: grit.
	A 408	~Plate 75	A 3 late	Temper: grit.
	A 559	~801	A 3 late	Temper: grit.
	A 408	~804	A 3 late	Temper: grit.
	A 465		A 3	Ware: fine cream. Temper: grit.
	A 447		A 3	Temper: grit and very little chaff.
	A 462		A 3	Temper: grit and some chaff.
A 409		A 3 late	Temper: grit.	
19c	A 584	876	A 3	Ware: medium fine green-buff, overfired. Temper: grit and chaff. Paint: dark brown, very faded. Rim sherd.
	Unstratified			Temper: grit.
	A 462, A 498	512	A 3	Ware: fine buff. Temper: grit. Paint: red horizontal bands and vertical stripes outside, concentric circles inside on base.
	A 470		A 4	Temper: grit and chaff.
	A 482		A 3 late	Temper: grit and chaff.
	Unstratified			Temper: grit.
	A 572		A 3 late	Temper: grit and chaff.
	Unstratified			Temper: grit and very little chaff.
19d	A 453	564	A 3	Ware: fine grey-buff. Temper: grit and chaff. Paint: red. Decoration: raised bands with incised slashes. Rim sherd.
	A 635		A 4	Temper: grit and very little fine chaff. Paint: very thick, low-fired bright red, Munsell colour 7.5R 4/8 "red"
	C 810		C 7	Temper: grit and some fine chaff.
	C 751	~879-881	C 7	Temper: very fine grit.
	C 1010		C 7	Temper: fine white grit. Paint: thick dark red, Munsell 10R 3/4 "dusky red". Deliberately cut disc.
19e	C 1014	~875	C 7	Temper: grit and chaff. Paint: Munsell 5YR 3/2 "dark reddish brown". Surface: Munsell 2.5Y 8/2 "white".
	A 633		A 3 late	Temper: grit and chaff. Paint: orange red. Sherd thickness 1 cm.
	C 78	~829	C 6	Temper: very fine grit.
	C 674	826	C 6a	Ware: fine salmon-pink. Temper: grit. Paint: red with splashes inside. Rim sherd.
	Unstratified			Ware: red. Inlay: white. Described on p. 56.
	C 225	1210	C 3 (Mitanni)	Ware: medium fine grey. Temper: grit. Surface: lightly burnished inside and out. Decoration: incised circles and impressed triangles, all white infilled. Rim sherd.
	C 224		C 1	Ware: grey-buff. Temper: grit.
19f	C 300		C 4	Ware: medium coarse yellow. Temper: grit. Decoration: polychrome glaze pattern. Discussed on p. 57.
	A 72, A 90	718, 719, 720	A 2	Ware: extremely fine buff. Temper: none. Paint: red to black bands with design overpainted in white.



a) Site A Khabur ware sherds



d) Khabur ware sherds

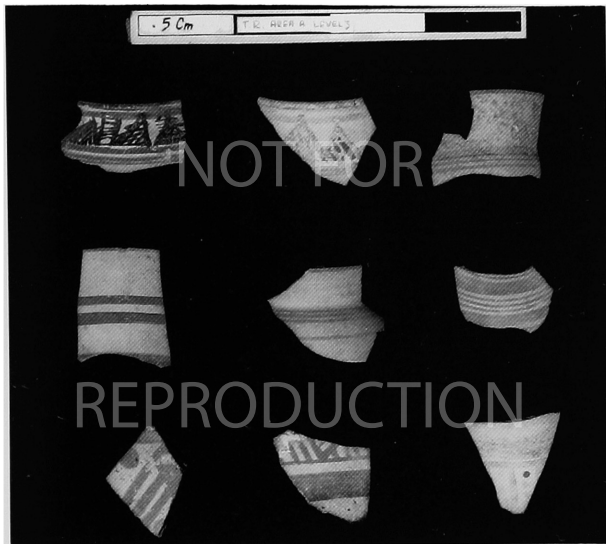

b) Site A Khabur ware sherds



e) Khabur ware, Old Babylonian and Late Assyrian sherds



c) Site A Khabur ware sherds

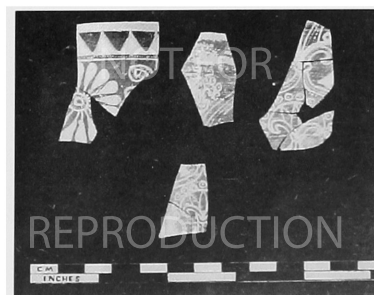

f) Site A Fine Nuzi ware sherds

PLATE 20

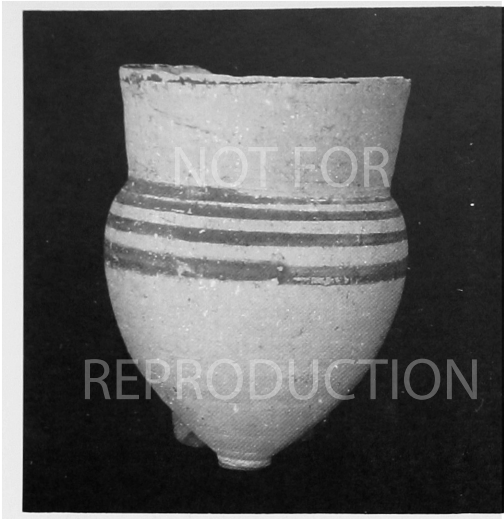

a) Late Old Babylonian beaker 804

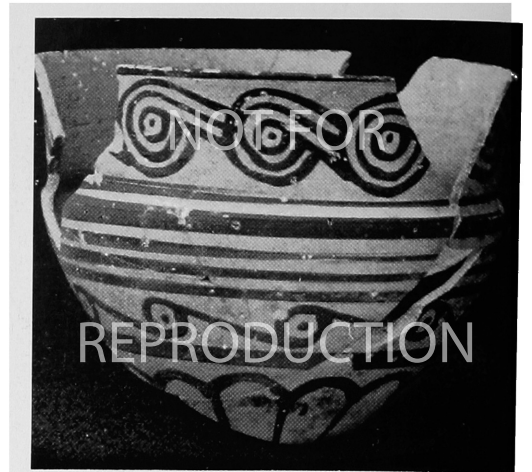

b) Late Old Babylonian beaker 824

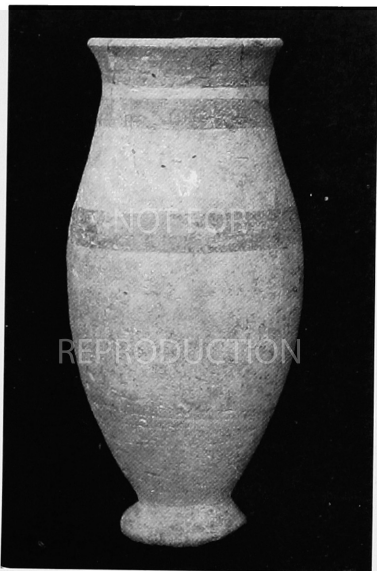

c) Middle Assyrian tall beaker 781

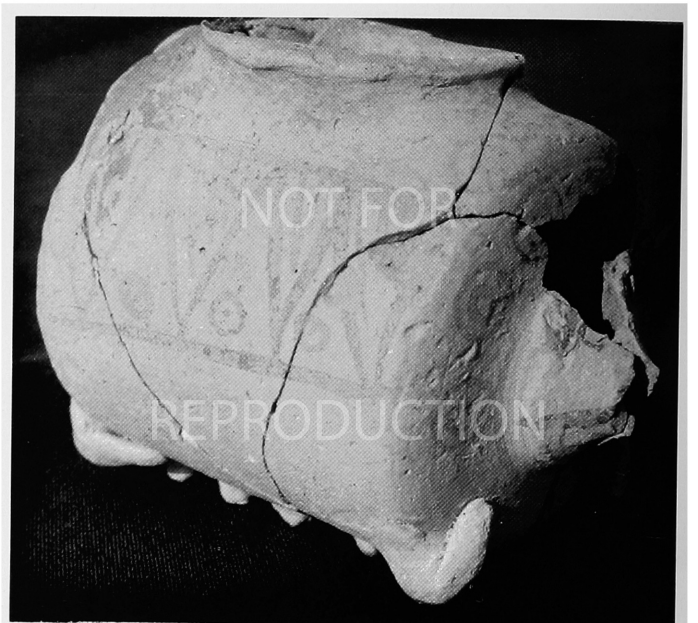

d) Mitanni pig pot 1186

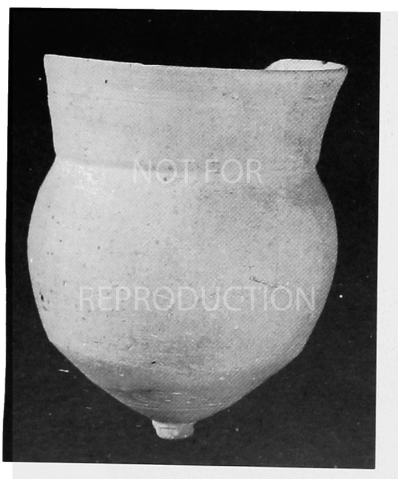

e) Mitanni nipple based beaker 729

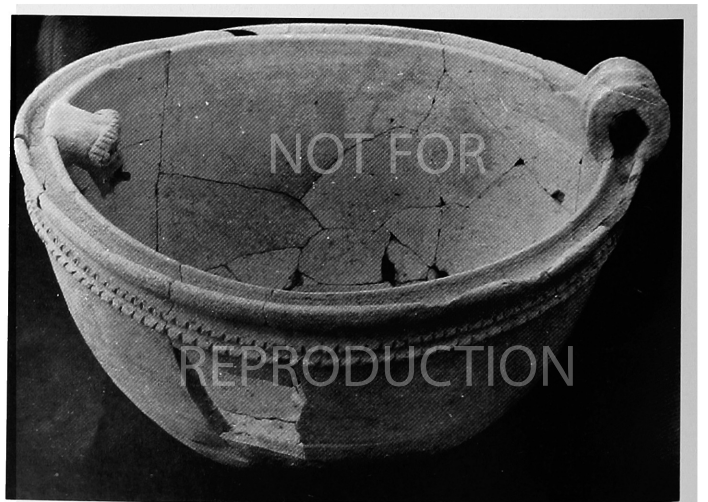

f) Mitanni spouted bowl 612



Site C Nuzi ware, courtesy of University Museum, Philadelphia

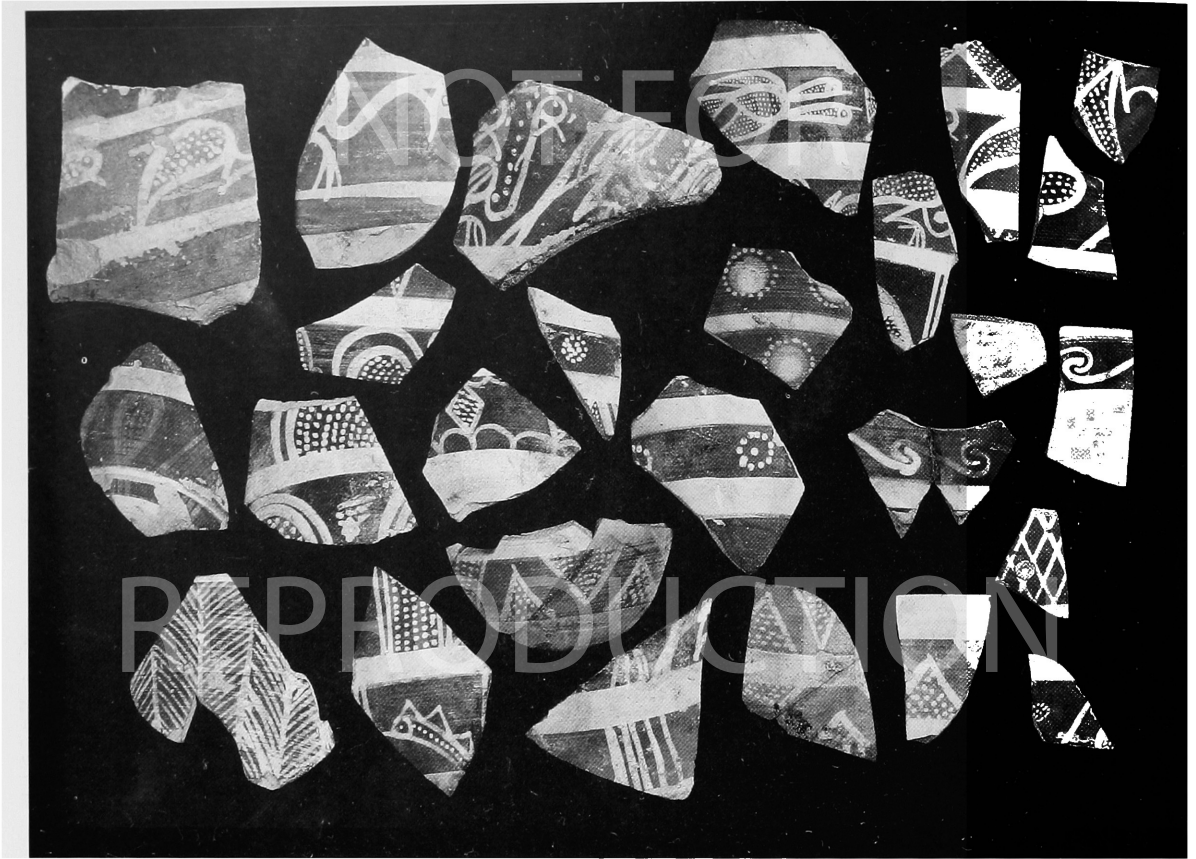

Site C Nuzi ware, courtesy of University Museum, Philadelphia

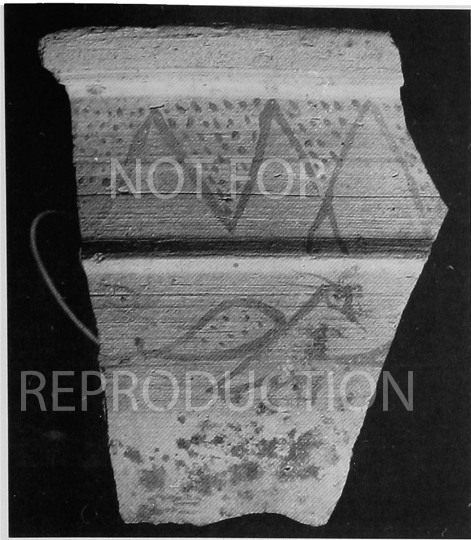

a) Early Mitanni sherd with bird ornament 1056



b) Nuzi ware, horned animal (C5b)

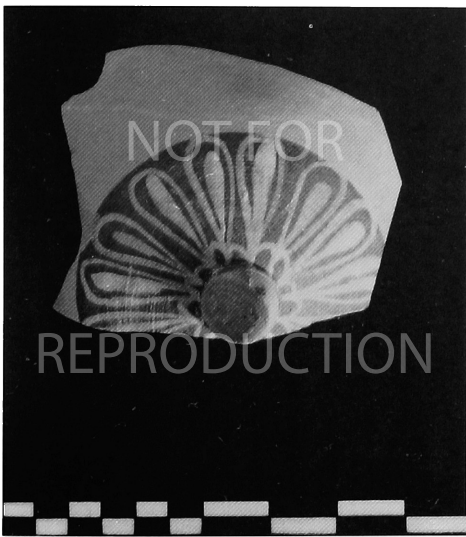

c) Nuzi ware beaker base 724

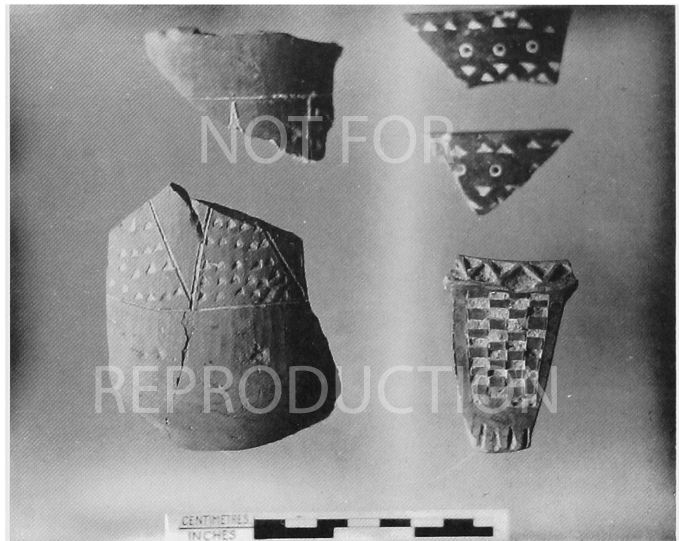

d) Mitanni grey ware, impressed ornament with white inlay (sherds 1205, 1209, 1202)



e) Fragment of Mitanni straight-sided, burnished, dark grey-brown vessel, inlaid on top and sides (TR 3325)

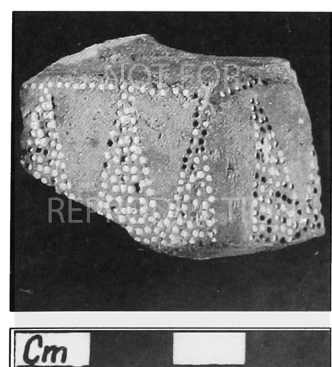

f) grey Mitanni vessel with white inlay; shape similar to (e)

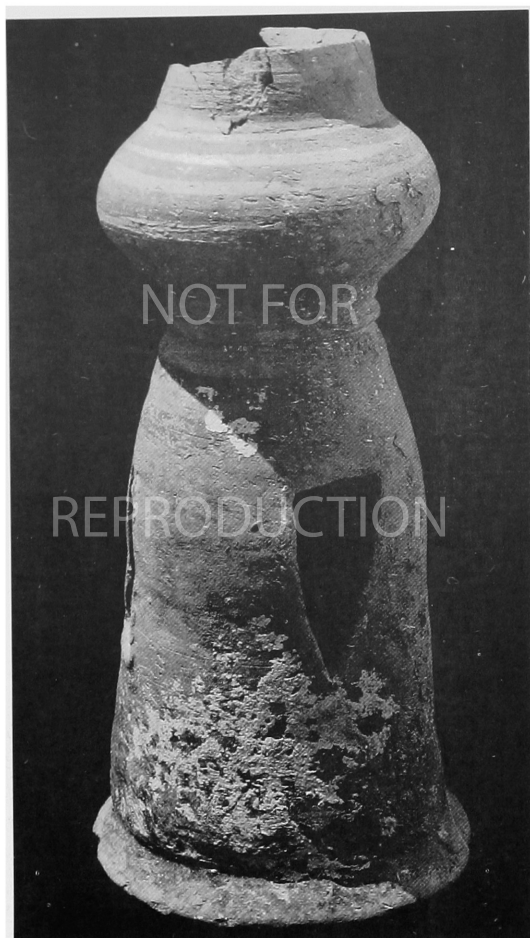

a) Tall stand 1180 from Room V in the Great Temple

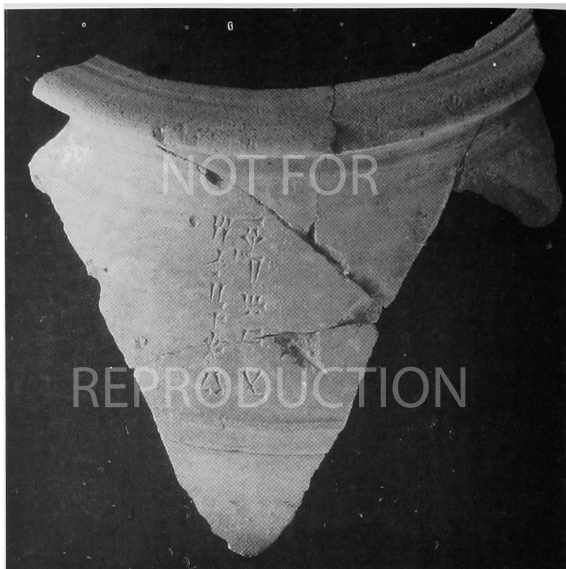

b) Inscription on storage jar 1036

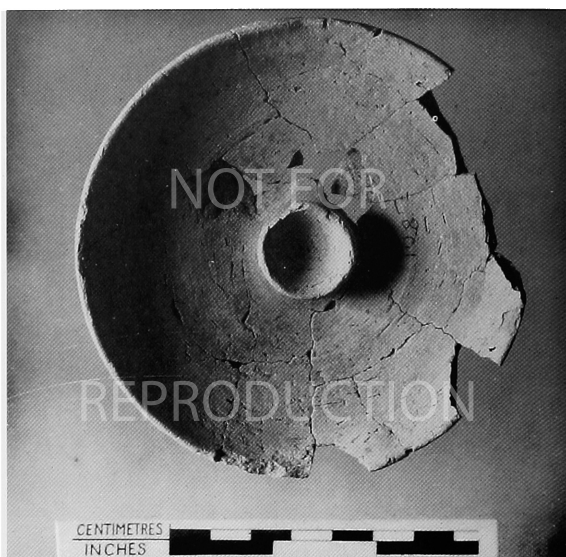

d) Old Babylonian lid 429



c) Fragment of Old Babylonian bread mould 1194



e) Mitanni architectural model 1192

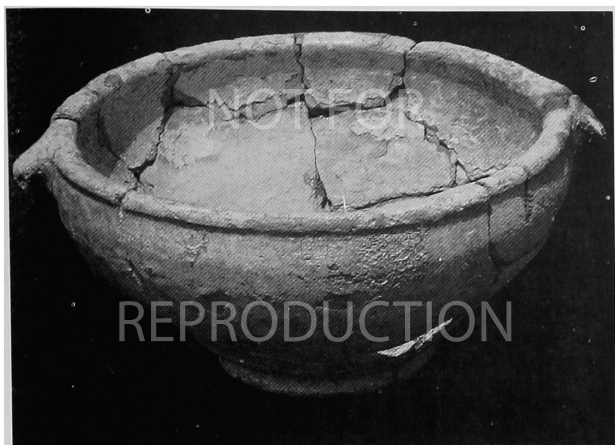

a) Middle Assyrian pale green glazed spouted bowl 1221, Site A Room 15 (TR 2608)



d) Wall cone from Site C Level 4 (TR5112)

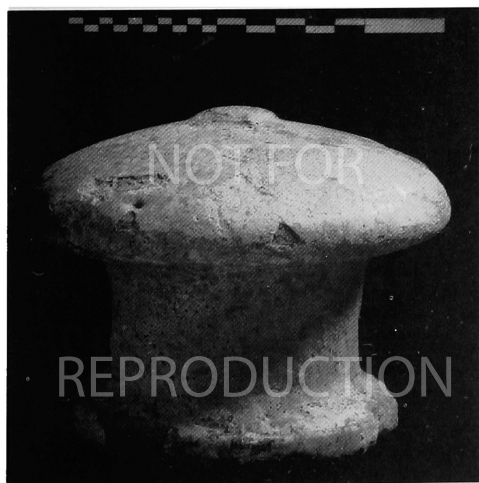
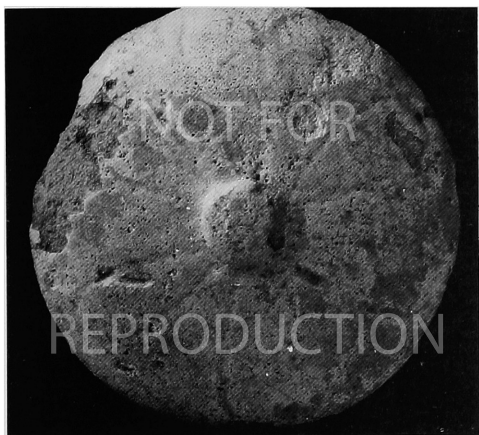

b, c) Mitanni green glazed wall cone from outside the east gate of the Great Temple (TR 2602)

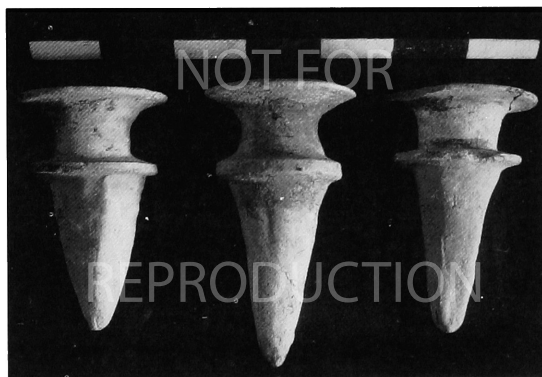

e) Wall cones, Site C Palace (TR 5126, 5130, 5135)

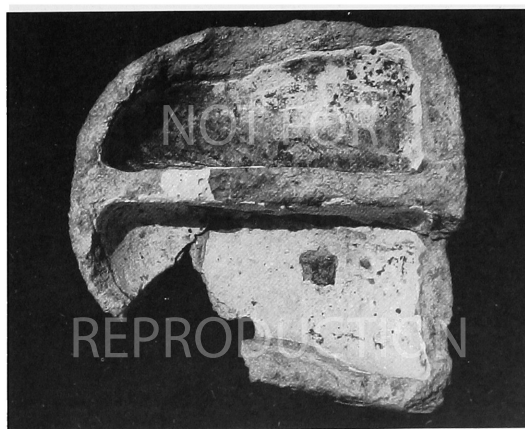

f) Pale green glazed compartmented dish (TR 4313), from the Late Assyrian shrine

Glazed pottery and wall cones

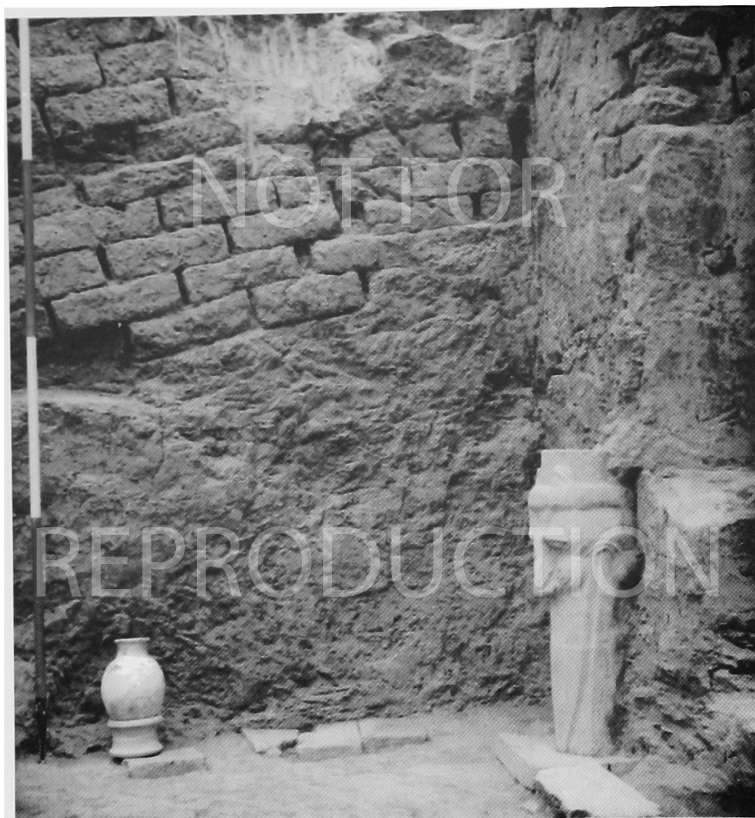

a) Late Assyrian shrine, jar 948 on potstand 1137 *in situ*

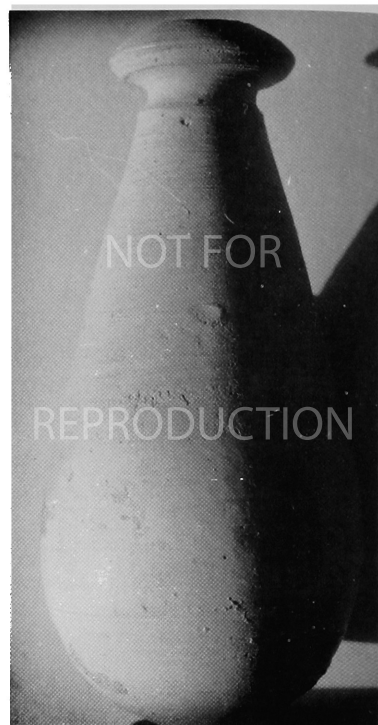

c) Late Assyrian bottle 928

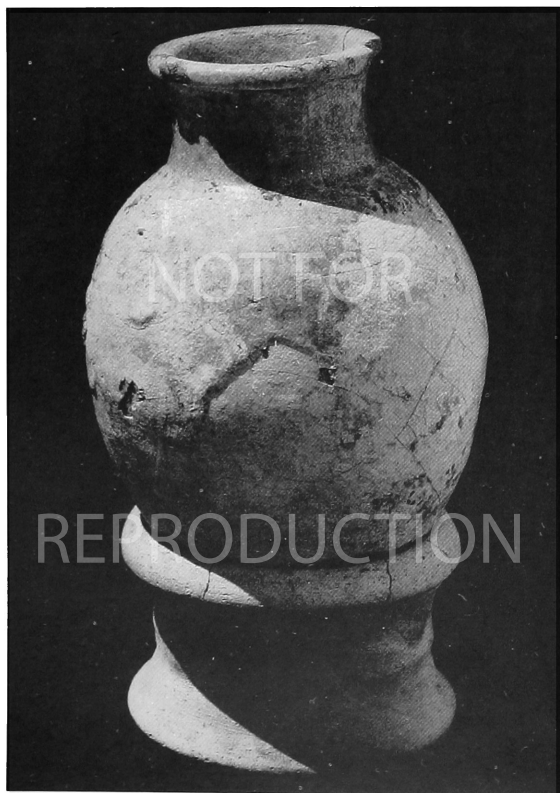

b) Jar 948 on potstand 1137

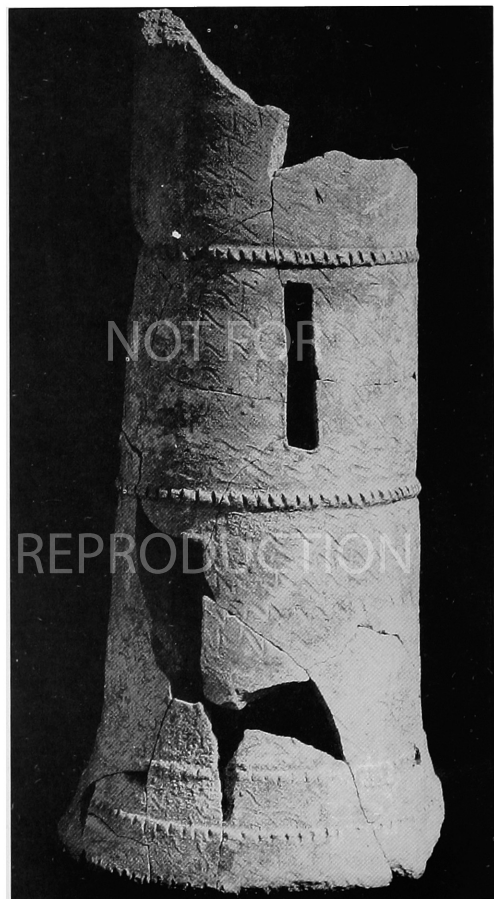

d) Tall stand 1175, Late Assyrian shrine



a) Post-Akkadian sherds (cf *Iraq* 32, 25ff.)

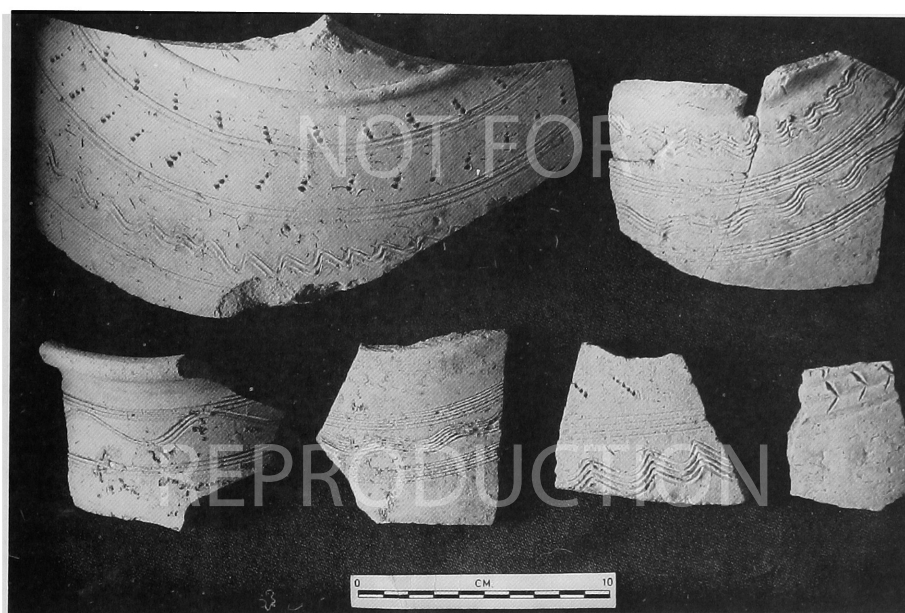

b) Post-Akkadian sherds (cf *Iraq* 32, 25ff.)

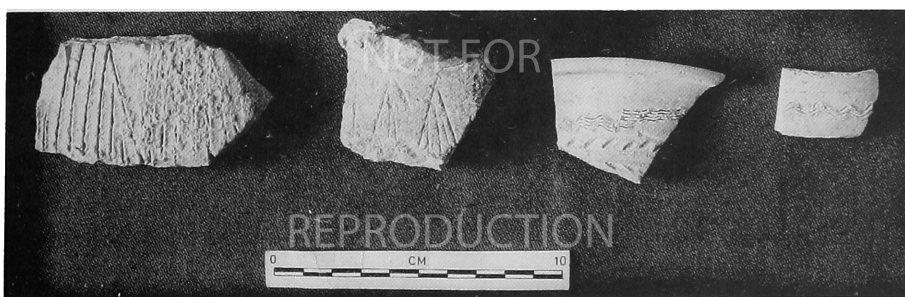

c) Akkadian sherds

Area AS, late third millennium BC sherds

PLATE 28

CARINATED BOWLS – MIDDLE ASSYRIAN

Pot No	TR No	Batch	Level	Dimensions	Range	Ware and Remarks
1		A 93	A 1	R: 30.6 cm H: 12.5 cm B: 14.0 cm	A 1-2 C 3-4	Ware: fine red with black core in parts. Temper: grit and a little chaff. Very well made. Profile.
2		C 66	C 1	R: 26.0 cm H: 8.2 cm B: 11.0 cm	A 1-2 C 2-4	Ware: medium coarse buff. Temper: grit and chaff. Surface: traces of plaster coating inside. Profile.
3		C	C 2	R: 24.2 cm H: 6.9 cm B: 11.4 cm	A 1-2 C 4-5	Ware: coarse green. Temper: grit and chaff. Very warped. Profile.
4		A 93 A 94	A 1	R: 24.0 cm H: 8.0 cm B: 8.0 cm	A 1 C 2	Ware: medium coarse pink-buff. Temper: grit and chaff. Surface: well smoothed inside and out. Profile.
5		A 93	A 1	R: 24.4 cm H: 8.0 cm B: 10.4 cm	A 1-2 C 3-4	Ware: medium coarse pink-buff. Temper: grit and chaff. Profile.
6		A 232	A 1	R: 23.6 cm H: 7.3 cm B: 10.0 cm	A 1-2 C 2-4	Ware: coarse light buff. Temper: chaff. Profile.
7		A 38	A 1c	R: 24.0 cm H: 8.2 cm B: 10.6 cm	A 1-2 C 1	Ware: medium coarse green. Temper: little fine chaff. Profile.
8		D 59	D 3	R: 22.6 cm H: 6.2 cm B: 8.6 cm	A 1 C 1-2	Ware: medium coarse pink-buff. Temper: grit and chaff. Profile.
9		A 257	Topsoil	R: 23.0 cm H: 7.9 cm B: 8.6 cm	A 1-2a C 1	Ware: coarse yellow-green. Temper: chaff. Profile.
10		A 401	A 1	R: 22.6 cm H: 6.8 cm B: 9.0 cm	A 1 C 3	Ware: coarse yellow. Temper: grit and chaff. Base: cracked in firing. Rim: warped. Profile.
11		A 401	A 1	R: 23.0 cm H: 7.3 cm B: 8.4 cm	C 4	Ware: coarse buff. Temper: chaff and large white grit. Profile.
12		A 401	A 1	R: 18.4 cm H: 7.5 cm B: 7.2 cm	A 1-2 C 1-5	Ware: medium coarse green. Temper: grit and much chaff. Surface: smoothed. Profile.
13		A 271	A 1	R: 18.4 cm H: 6.2 cm B: 8.6 cm	A 1-2 C 1-4	Ware: coarse green. Temper: chaff. Profile.
14		A 271	A 1	R: 17.2 cm H: 6.2 cm B: 9.4 cm	A 1	Ware: coarse buff. Temper: grit and chaff. Profile.
15		C 512	C 1-2	R: 17.0 cm H: 6.5 cm B: 8.0 cm	A 1-2 C 1-5	Ware: medium fine buff. Temper: grit and chaff. Surface: well smoothed. Profile.
16	4107	A	A 2a	R: 19.0 cm H: 5.7 cm B: 7.2 cm	C 2-3	Ware: medium coarse light buff. Temper: grit and chaff. Complete.
17		A 352	A 2a-b	R: 25.2 cm H: 6.8 cm B: 11.4 cm	A 1	Ware: coarse light buff. Temper: chaff. Profile.
18		A 310	A 2	R: 26.0 cm H: 7.4 cm B: 11.0 cm	A 1-2 C 1-2	Ware: coarse buff. Temper: grit and chaff. Profile.
19		A 481	A 2a	R: 24.6 cm H: 8.6 cm B: 11.0 cm	A 2a C 2-4	Ware: coarse buff. Temper: grit and chaff. Base: uneven. Profile.
20		A 310	A 2	R: 28.0 cm H: 8.2 cm B: 13.6 cm	A 1-2a C 1-4	Ware: coarse pale buff. Temper: grit and chaff. Surface: smoothed. Warped. Base: hole in centre D: 4.8 cm with bitumen around hole. Profile.
21		A 243	A 1	R: 27.4 cm H: 10.1 cm B: 13.4 cm	A 2a C 1-5	Ware: coarse buff. Temper: grit and chaff. Profile.

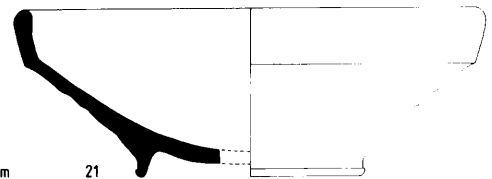
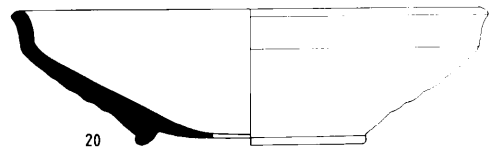
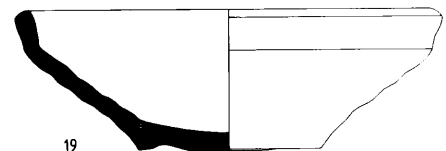
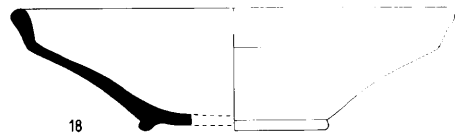
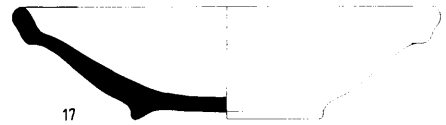
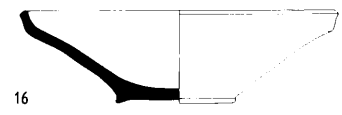
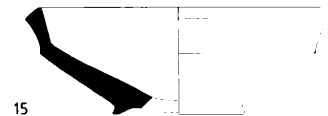
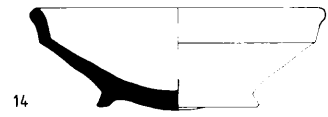
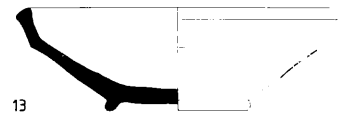
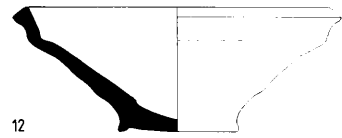
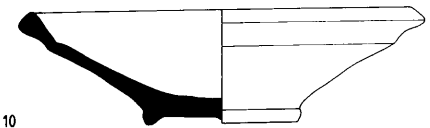
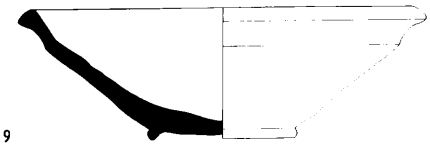
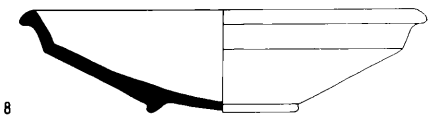
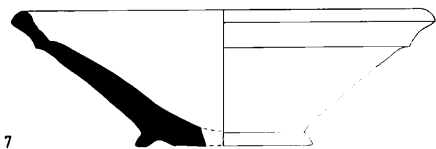
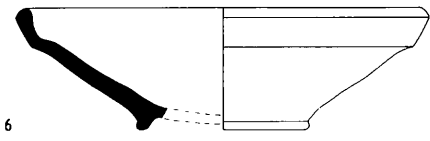
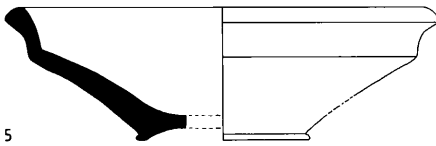
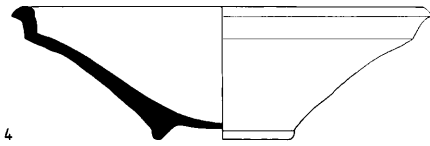
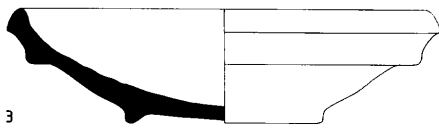
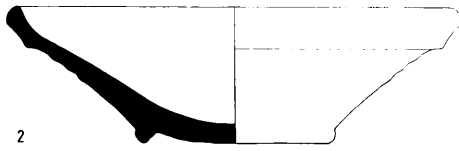
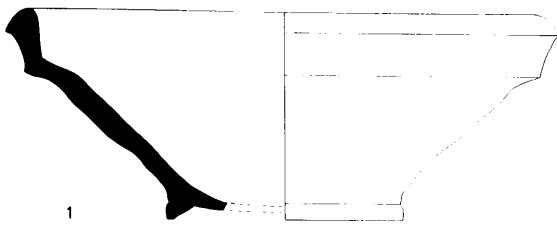

PLATE 29

CARINATED BOWLS – MIDDLE ASSYRIAN

Pot No	TR No	Batch	Level	Dimensions	Range	Ware and Remarks
22		A 271		R: 21.6 cm H: 7.5 cm B: 10.0 cm	A 1 C 1-5	Ware: coarse green. Temper: grit and chaff. Profile.
23		A 93 A 94	A 1	R: 21.0 cm H: 6.4 cm B: 9.0 cm	A 1	Ware: medium coarse green-buff. Temper: grit and little chaff. Surface: smoothed. Base: string-cut. Profile.
24		A 93	A 1	R: 15.6 cm H: 5.0 cm B: 6.0 cm		Ware: medium fine green. Temper: grit and fine chaff. Surface: well smoothed inside. Profile.
25		D 57	D 3	R: 17.0 cm H: 5.0 cm B: 7.6 cm	A 1 C 4	Ware: medium coarse pink-buff. Temper: grit and chaff. Profile.
26		A 229	A 1	R: 18.6 cm H: 5.4 cm B: 7.5 cm		Ware: coarse light buff. Temper: grit and chaff. Profile.
27		C 717 C 718	C 1-2	R: 15.6 cm H: 4.8 cm B: 7.0 cm	C 4	Ware: medium coarse green. Temper: grit and chaff. Base: string-cut. Profile.
28		A 236	A 1	R: 16.4 cm H: 5.3 cm B: 7.0 cm	A 1 C 1-3	Ware: medium coarse buff. Temper: grit and chaff. Profile.
29		A 17	A 1	R: 16.0 cm H: 4.4 cm B: 6.0 cm	A 1	Ware: medium coarse buff. Temper: grit and chaff. Profile.

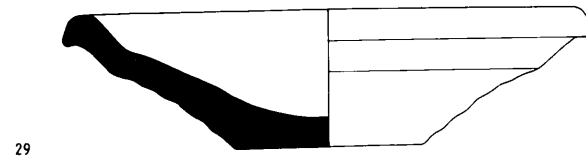
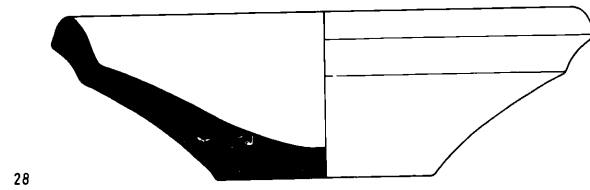
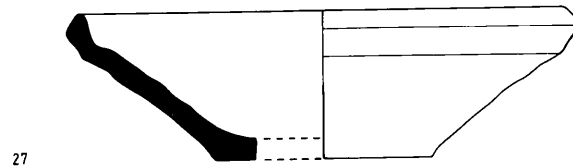
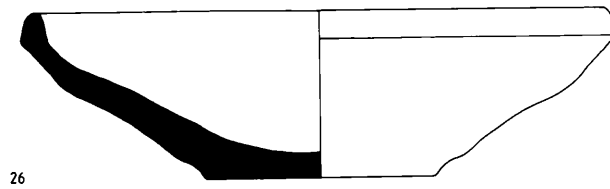
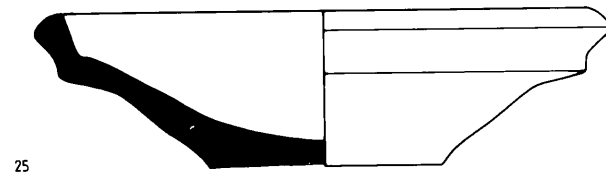
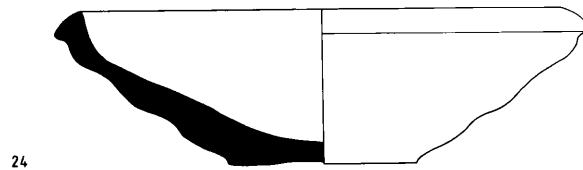
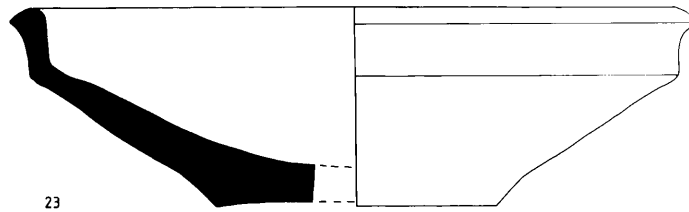
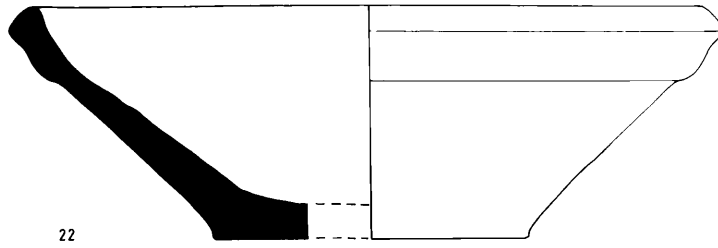

PLATE 30

CARINATED BOWLS – MIDDLE ASSYRIAN

Pot No	TR No	Batch	Level	Dimensions	Range	Ware and Remarks
30		A 328	A 1	R: 15.0 cm H: 4.2 cm B: 6.6 cm	A 2a C 1-4	Ware: coarse light buff. Temper: chaff. Profile.
31		C	C 2-3	R: 16.2 cm H: 3.9 cm B: 6.4 cm	A 2a	Ware: medium fine pale green. Temper: grit and chaff. Surface: traces of bitumen on base. Profile.
32	2138	A 228	A 1b	R: 16.4 cm H: 4.8 cm B: 5.6 cm	C 4	Ware: coarse buff. Temper: chaff. Complete.
33		A 228	A 1b	R: 15.4 cm H: 4.0 cm B: 5.4 cm	A 2c	Ware: coarse yellow. Temper: chaff. Profile.
34		A 301	A 1	R: 5.5 cm H: 3.8 cm B: 6.4 cm		Ware: medium fine buff. Temper: grit and chaff. Profile.
35		A 96	A 1	R: 13.8 cm H: 4.2 cm B: 5.5 cm		Ware: fine pale green. Temper: grit and much fine chaff. Base: string-cut. Surface: burnished. Profile.
36		D 53 DG 2-66	D 3	R: 14.0 cm H: 4.2 cm B: 5.0 cm		Ware: medium coarse green. Temper: grit and chaff. Profile.
37		A 259	A 1	R: 14.8 cm H: 4.6 cm B: 5.2 cm	A 1 C 2	Ware: medium coarse buff. Temper: grit and chaff. Profile.
38		A 293	A 2 Mixed	R: 14.2 cm H: 4.5 cm B: 5.0 cm	A 1-2a C Tops	Ware: coarse green. Temper: chaff. Profile.
39		A 257	Topsoil	R: 14.0 cm H: 4.0 cm B: 4.0 cm	A 1	Ware: medium coarse green-buff. Temper: chaff. Base: string-cut. Profile.
40		A 231	Topsoil	R: 12.6 cm H: 3.8 cm B: 5.6 cm	C Tops	Ware: medium coarse red-buff. Temper: white grit and chaff. Surface: interior coated with plaster. Profile.
41		D 154	D 3	R: 11.0 cm H: 3.5 cm B: 4.5 cm	C 1-2	Ware: medium fine green-buff. Temper: grit. Burning on rim along one side. Profile.
42		C 726	C 4	R: 10.0 cm H: 3.4 cm B: 4.4 cm	A 2 C 4	Ware: fine buff. Temper: grit. Base: cracked in firing. Profile.
43		A 254	Topsoil	R: 11.8 cm H: 3.3 cm B: 4.4 cm	C 4	Ware: fine buff. Temper: grit and chaff. Profile.
44		A 461	A 1	R: 12.0 cm H: 3.6 cm B: 4.7 cm	A 1-2c C 1	Ware: medium fine pink-buff. Temper: grit and chaff. Base: warped oval. Profile.
45		C	C 2	R: 11.4 cm H: 3.6 cm B: 5.0 cm	A 1-2a C 4-5	Ware: fine red-brown. Temper: small white grit. Profile.
46		A 17	A 1	R: 12.0 cm H: 4.0 cm B: 5.0 cm	C 2	Ware: medium coarse buff. Temper: grit and chaff. Profile.
47		C 529	C 3	R: 11.8 cm H: 4.6 cm B: 5.0 cm	A 2c C 1-5	Ware: medium fine green. Temper: grit and little chaff. Profile.
48		D 33	D 3	R: 16.2 cm H: 5.7 cm B: 7.0 cm	C 1-4	Ware: medium coarse green. Temper: grit and chaff. Profile.

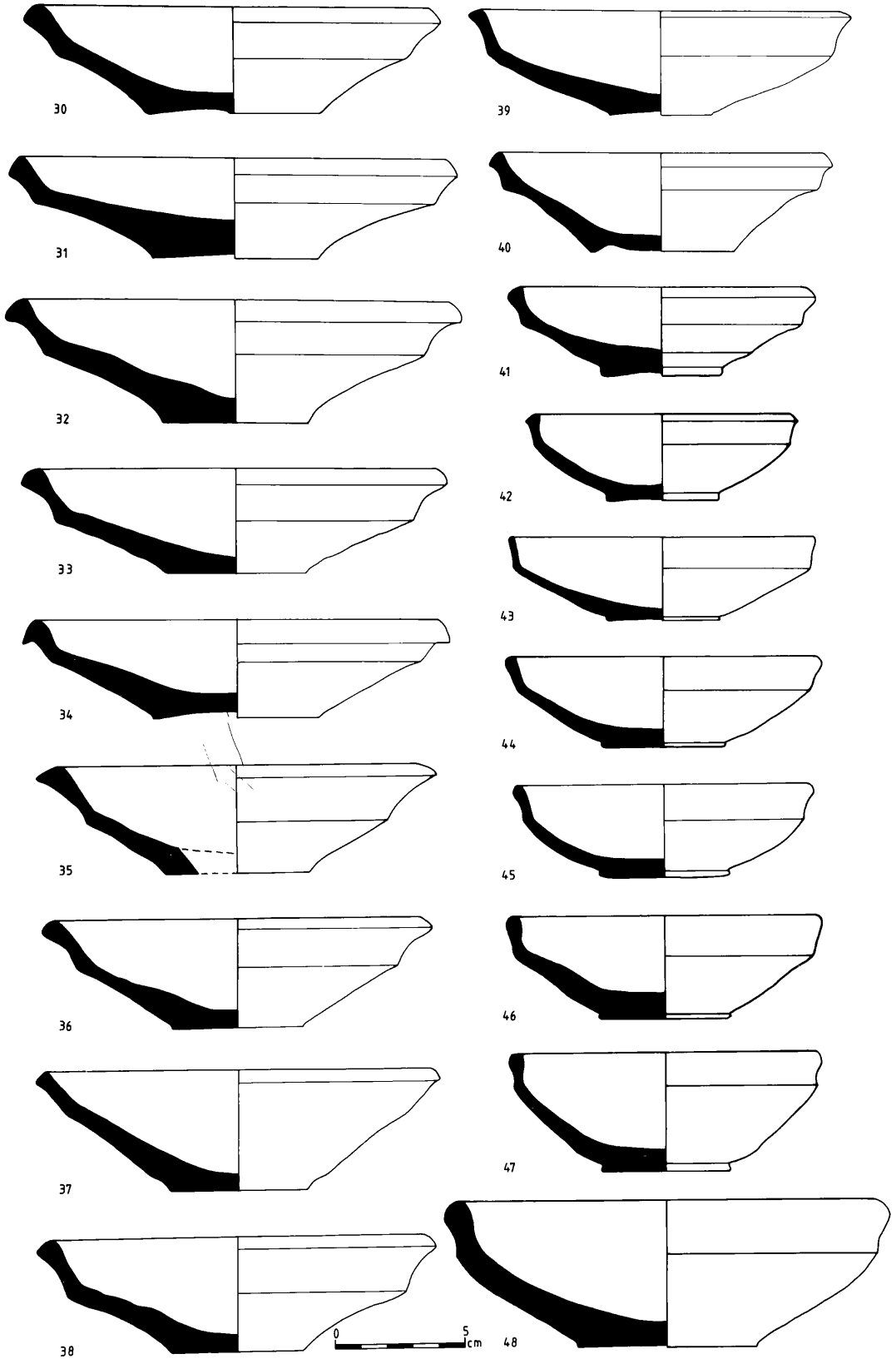

PLATE 31

CARINATED BOWLS – MIDDLE ASSYRIAN AND MITANNI

Pot No	TR No	Batch	Level	Dimensions	Range	Ware and Remarks
49		A 258	A 1	R: 11.0 cm H: 4.0 cm	A 2	Ware: fine pale buff. Temper: grit and chaff. Base: string-cut, then smoothed.
50		A 301	A 1	R: 9.8 cm H: 3.5 cm	A 1-2c	Ware: medium fine buff. Temper: chaff. Base: string-cut, then smoothed. Profile.
51		A 98	A 2a	R: 9.0 cm H: 3.7 cm	A 2	Ware: medium fine buff. Temper: grit and chaff. Complete.
52		A 259	A 1	R: 9.0 cm H: 3.5 cm		Ware: coarse buff. Temper: chaff. Profile.
53		D 49	D 3	R: 9.4 cm H: 3.6 cm	A 2	Ware: medium fine buff. Temper: chaff. Profile.
54		A 289	A 1	R: 9.0 cm H: 3.2 cm	A 1	Ware: medium fine buff. Temper: white grit and chaff. Profile.
55		A 33	A 1	R: 9.0 cm H: 4.2 cm	A 2a	Ware: medium fine buff. Temper: large grit and chaff. Well finished. Profile.
56		A 228	A 1c	R: 8.8 cm H: 3.5 cm	A 1 C 3-4	Ware: medium fine light red-buff. Temper: grit and chaff. Profile.
57		A 94	A 1b	R: 8.8 cm H: 3.5 cm	A 2	Ware: fine buff. Temper: fine grit and chaff. Base: string-cut. Very well made. Profile.
58		A 287	A 1	R: 9.1 cm H: 3.3 cm		Ware: medium fine buff. Temper: grit and chaff. Base: string-cut, rough. Profile.
59		A 468	A 1	R: 9.5 cm H: 3.9 cm		Ware: medium coarse green. Temper: grit and chaff. Base: warped oval. Profile.
60		A 92	A 2	R: 9.0 cm H: 3.0 cm		Ware: medium fine buff. Temper: grit and chaff. Base: string-cut. Well made. Profile.
61		A 259	A 1	R: 7.7 cm H: 3.0 cm		Ware: medium coarse green-buff. Temper: chaff. Surface: stained with bitumen on rim and inside. Profile.
62		C 718	C 1, 2	R: 8.5 cm H: 3.0 cm		Ware: medium coarse yellow. Temper: grit and chaff. Profile.
63		A 328	A 1	R: 8.8 cm H: 2.8 cm		Ware: coarse green. Temper: chaff. Profile.
64		C 223	C 2	R: 9.8 cm H: 3.0 cm		Ware: medium fine buff. Temper: grit. Profile.
65		A 250	A 1	R: 11.2 cm H: 4.6 cm	C 1-2	Ware: medium coarse brick-red. Temper: grit and chaff. Profile.
66		A 328	A 1	R: 9.8 cm H: 3.5 cm	A 1	Ware: coarse green. Temper: chaff. Profile.
67		A 228	A 1b	R: 10.0 cm H: 3.5 cm		Ware: medium fine buff. Temper: grit and chaff. Base: string-cut, then smoothed. Profile.
68		A 259	A 1	R: 9.3 cm H: 3.2 cm		Ware: medium coarse buff. Temper: grit and chaff. Profile.
69		D	D 3	R: 9.3 cm H: 3.0 cm	A 2a-2c	Ware: medium fine pink-buff. Temper: grit and chaff. Profile.
70		B	B LA	R: 9.4 cm H: 3.1 cm		Ware: medium fine buff. Temper: grit and chaff. Profile.
71		A 259	A 1	R: 10.3 cm H: 3.0 cm		Ware: coarse buff. Temper: chaff. Profile.
72		A 44	A 1	R: 11.0 cm H: 3.5 cm	A 2a C 4-6a	Ware: fine buff. Temper: large white grit. Profile.
73		A 96	A 1	R: 13.2 cm H: 3.8 cm		Ware: fine green. Temper: grit and chaff. Base: string-cut. Surface: very smooth. Profile.

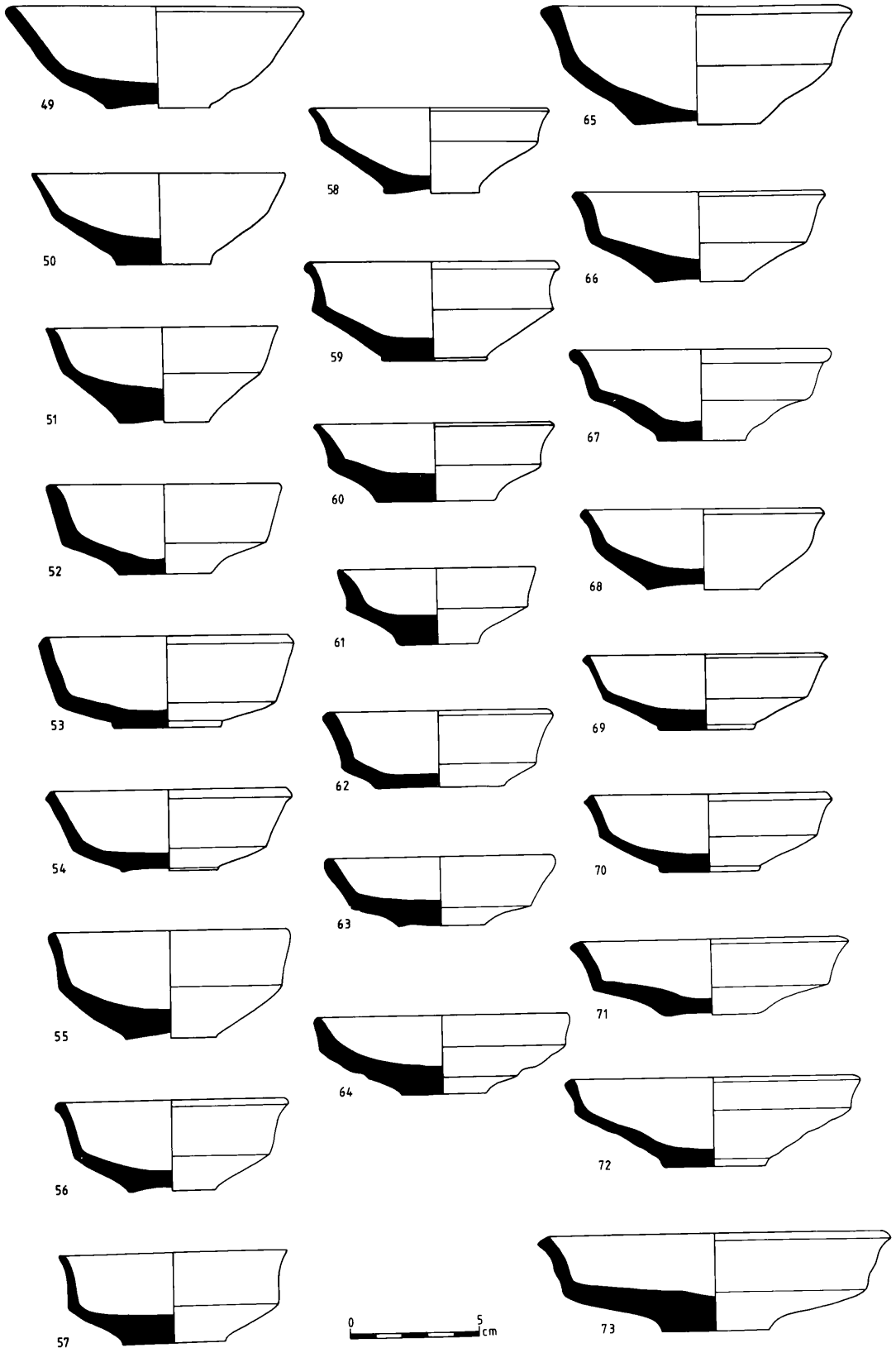
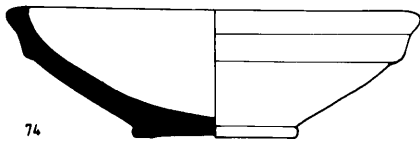

PLATE 32

CARINATED BOWLS – MITANNI

Pot No	TR No	Batch	Level	Dimensions	Range	Ware and Remarks
74	5053	CG 17-68	C 5b	R: 12.5 cm H: 4.1 cm B: 5.2 cm	C 4	Ware: medium fine orange-buff. Temper: white grit and chaff. Surface: burnished on rim. Contained some finger-bones. Found with Pot 751. Complete.
75		A 40	A 2b	R: 11.0 cm H: 3.5 cm B: 4.6 cm	C 4-6a	Ware: medium fine buff. Temper: grit. Almost complete.
76		A 20	A 2a-b	R: 11.2 cm H: 4.0 cm B: 4.4 cm	A 1-2a C 5	Ware: fine buff. Temper: grit. Surface: smoothed. Profile.
77		A 72 A 74 A 88 A 90	A 2a	R: 10.2 cm H: 3.5 cm B: 3.7 cm		Ware: fine buff to green. Temper: large white grit. Profile.
78		A 72 A 74 A 88 A 90	A 2a	R: 11.6 cm H: 3.7 cm B: 4.0 cm	A 2a C 5	Ware: fine buff to green. Temper: large white grit. Almost complete.
79		A 57	A 2a-b	R: 12.0 cm H: 4.0 cm B: 4.6 cm		Ware: fine red. Temper: fine grit and chaff. Profile.
80		A 336	A 2a-b	R: 10.2 cm H: 3.2 cm B: 4.0 cm	A 1-2	Ware: fine orange with dark core. Temper: fine grit. Surface: burnished inside and out. Profile.
81		A 352	A 2a-b	R: 12.6 cm H: 3.8 cm B: 5.7 cm	C 4-5	Ware: medium coarse buff. Temper: chaff. Profile.
82		A 20	A 2a-b	R: 11.2 cm H: 2.7 cm B: 3.7 cm		Ware: medium fine buff. Temper: white grit. Profile.
83	6006	C 677	C 5	R: 14.2 cm H: 4.5 cm B: 5.4 cm	C 2-3	Ware: medium coarse yellow. Temper: grit and chaff. Base: cracked in firing. Complete.
84		C 688	C 5	R: 10.6 cm H: 3.2 cm B: 4.0 cm	C 4	Ware: fine hard green. Temper: grit. Trace of burning at one point on rim. Profile.
85		C 903	Mixed	R: 12.0 cm H: 3.3 cm B: 4.5 cm	C 1-5	Ware: fine green. Temper: some large white grit. Profile.
86	3101	DG 22-66	D 4	R: 11.8 cm H: 4.0 cm B: 5.2 cm	C 6a	Ware: medium fine green. Temper: grit and chaff. Warped. Complete.
87		C 578	C 5	R: 8.0 cm H: 2.4 cm B: 4.0 cm		Ware: fine red. Temper: grit and chaff. Base: turned when leather-hard. Trace of burning at one point on rim. Profile.
88	6005	C 631 CG 4-71	C 1	R: 12.5 cm H: 3.7 cm B: 7.0 cm	C 6a	Ware: medium coarse buff to cream. Temper: grit and chaff. Found near head of adult burial. Complete.
89	3100	DG 22-66	D 4	R: 11.4 cm H: 3.5 cm B: 5.0 cm	C 4	Ware: medium fine buff. Temper: grit and chaff. Complete.
90	3102	DG 22-66	D 4	R: 13.5 cm H: 3.0 cm B: 5.0 cm		Ware: medium fine light buff. Temper: grit and chaff. Complete.
91		C 903	Mixed	R: 12.3 cm H: 3.2 cm B: 4.5 cm		Ware: very fine green. Temper: fine grit. Surface: well smoothed. Base: string-cut. Profile.



74

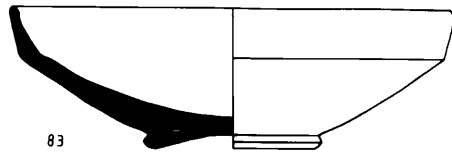

83

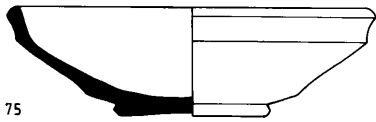

75

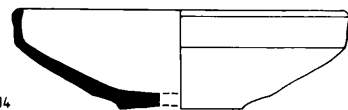

84

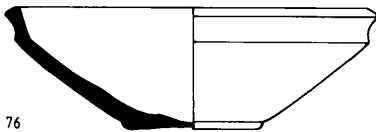

76

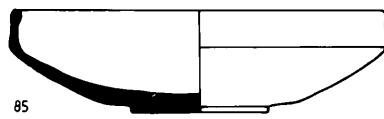

85

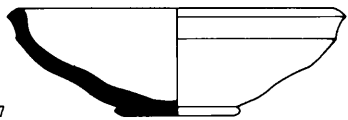

77

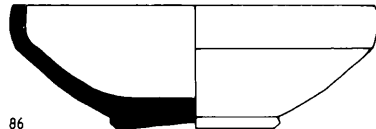

86

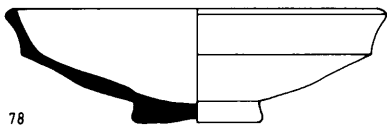

78

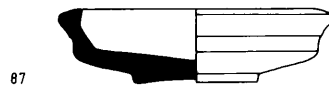

87

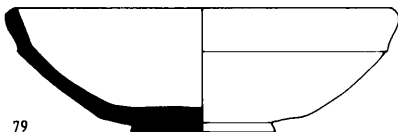

79

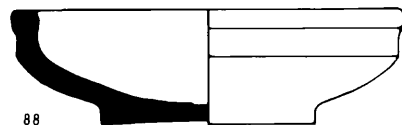

88

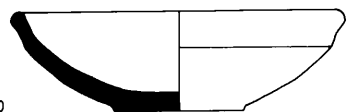

80

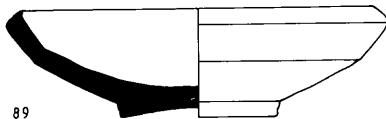

89

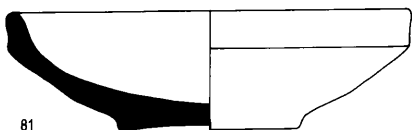

81



90

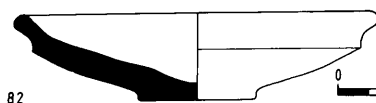

82

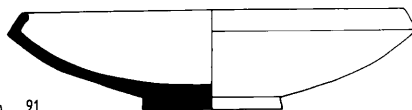

91

PLATE 33

CARINATED BOWLS – MITANNI

Pot No	TR No	Batch	Level	Dimensions	Range	Ware and Remarks
92		A 41	A 2a-b	R: 24.0 cm H: 6.9 cm B: 11.0 cm	A 2 C 4	Ware: medium fine red. Temper: grit and chaff. Profile.
93		A 72 A 74 A 88 A 90	A 2a	R: 17.2 cm H: 5.3 cm B: 9.0 cm	A 2	Ware: medium fine buff. Temper: fine grit and chaff. Profile.
94		A 42	A 1	R: 15.4 cm H: 6.9 cm B: 6.2 cm	C 6a	Ware: fine red to orange. Temper: grit and fine chaff. Well-made. Surface: lightly burnished. Almost complete.
95		A 473	A 1	R: 10.6 cm H: 3.5 cm B: 5.2 cm		Ware: medium fine buff. Temper: grit and chaff. Profile.
96		A 473 A 489	A 1-2a	R: 11.2 cm H: 4.4 cm B: 6.2 cm	A 2a-b C 4	Ware: medium coarse grey. Temper: grit and chaff. Profile.
97	2100	A 62	A 2a-b	R: 9.8 cm H: 3.6 cm B: 5.0 cm	A 1	Ware: medium coarse light green. Temper: small buff grit. Complete.
98		A 23	A 2	R: 11.6 cm H: 3.9 cm B: 4.6 cm	C 2-5	Ware: medium coarse buff. Temper: grit and chaff. Profile.
99		A 308	A 2a	R: 9.8 cm H: 3.7 cm B: 6.0 cm	A 2a C 6a	Ware: medium fine buff. Temper: grit and chaff. Profile.
100		C 17	C 4	R: 8.7 cm H: 3.3 cm B: 4.3 cm		Ware: medium fine pink to white. Temper: grit and chaff. Surface: burnished inside and out. Profile.
101		A 352	A 2a-b	R: 11.0 cm H: 3.1 cm B: 4.0 cm	A 2	Ware: medium fine buff. Temper: grit and chaff. Profile.
102		A 95	A 2	R: 14.0 cm H: 4.0 cm B: 7.0 cm	A 1-2a	Ware: coarse buff. Temper: grit and chaff. Surface: smoothed inside. Profile.
103		A 95	A 2	R: 10.2 cm H: 3.8 cm B: 5.0 cm		Ware: medium fine buff. Temper: grit and chaff. Profile.
104		A 25	A 2c	R: 11.2 cm H: 4.0 cm B: 6.0 cm	C 1-2	Ware: fine buff. Temper: grit and chaff. Profile.

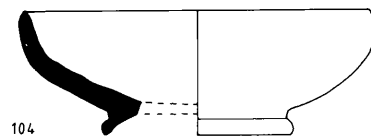
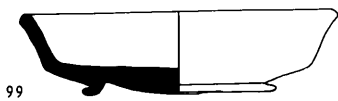
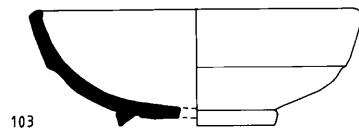
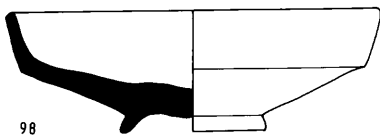
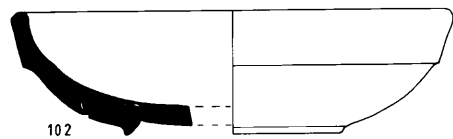
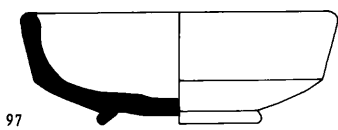
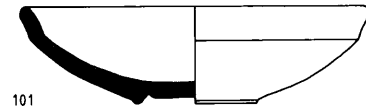
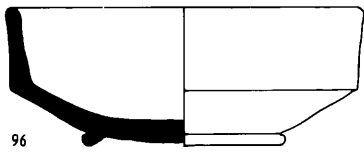
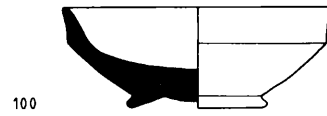
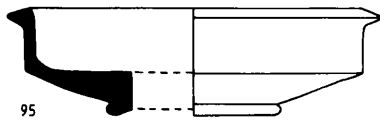
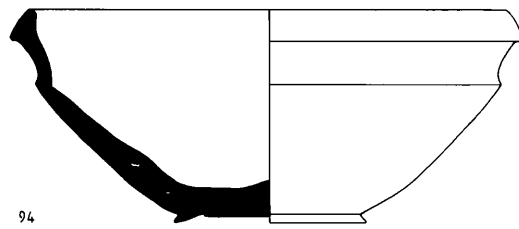
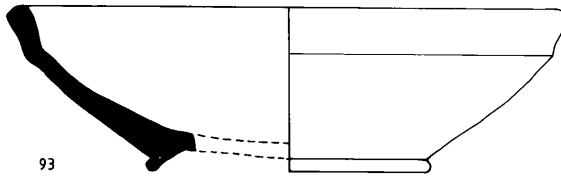
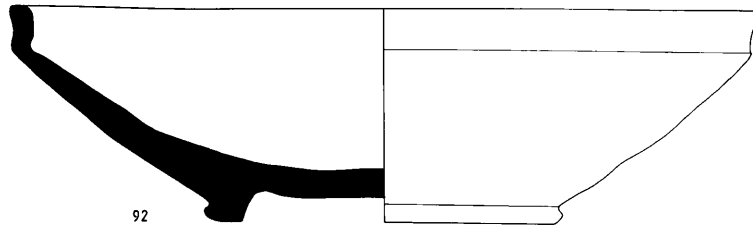

PLATE 34

RED-RIMMED BOWLS – MIDDLE ASSYRIAN AND MITANNI

Pot No	TR No	Batch	Level	Dimensions	Range	Ware and Remarks
105		C 649	C 4	R: 45.0 cm H: 10.6 cm B: 20.5 cm	A 1-2c C 1-5	Ware: medium coarse pink. Temper: grit and chaff. Slip: light cream inside, red on rim. Surface: burnished on rim and inside. Profile.
106	5024	C 248 C 270	C 3	R: 33.0 cm H: 8.3 cm B: 12.6 cm	A 1-2c C 1-5	Ware: medium coarse red. Temper: grit and chaff. Slip: dark red on rim. Surface: smoothed. Almost complete.
107		C 25 C 55	C 4	R: 28.0 cm H: 5.8 cm B: 12.8 cm	A 1-2a C 1-4	Ware: medium coarse orange. Temper: grit and chaff. Slip: white inside, red on rim. Surface: burnished inside. Profile.
108		A 58	A 2-3	R: 29.0 cm H: 8.1 cm B: 9.5 cm	A 1-2c C 1-5	Ware: medium coarse buff. Temper: grit and chaff. Slip: orange inside, red on rim. Surface: burnished on red slip. Profile.
109		D 162	D 4	R: 33.0 cm H: 10.2 cm B: 8.0 cm	A 1-2c C 1-5	Ware: medium coarse buff. Temper: grit and chaff. Slip: white inside, red on rim. Surface: burnished on red slip. Profile.
110		A 551	A 3 late	R: 30.0 cm H: 7.4 cm B: 9.4 cm	A 2	Ware: medium coarse buff. Temper: grit and chaff. Slip: red on rim. Surface: burnished on rim and inside. Profile.
111		A 15	A 1-2	R: 27.0 cm H: 8.0 cm B: 9.0 cm	C 1-5	Ware: medium coarse buff. Temper: grit and chaff. Slip: red on rim. Surface: burnished on rim. Profile.
112		A 551	A 3 late	R: 30.4 cm H: 5.0 cm	A 1-2c C 1-5	Ware: medium coarse buff. Temper: grit and chaff. Slip: red on rim. Surface: burnished on rim and outside. Base: missing. Rim sherd.
113		C 525	C 4	R: 22.0 cm H: 5.5 cm B: 7.6 cm	C 2-4	Ware: medium coarse red. Temper: white grit and chaff. Slip: red on rim. Surface: burnished on rim and inside. Profile.
114		C	C 1-2	R: 19.0 cm H: 6.4 cm B: 9.2 cm	A 2b C 4	Ware: medium coarse buff. Temper: grit and chaff. Slip: red on rim. Surface: burnished on rim and inside. Profile.
115		A 619	A 2	R: 20.0 cm H: 4.0 cm B: 8.3 cm	A 2c C 1	Ware: medium coarse pink. Temper: grit and chaff. Slip: white inside and out, red near rim and inside. Surface: burnished on red slip. Profile.
116		A 36 A 49	Mixed	R: 17.0 cm H: 4.0 cm B: 10.5 cm		Ware: medium coarse buff. Temper: grit and chaff. Slip: dark red on rim. Surface: burnished on rim. Profile.
117		A 36 A 49	Mixed	R: 19.0 cm H: 5.3 cm B: 10.0 cm	A 2a	Ware: medium coarse buff. Temper: grit and chaff. Slip: orange inside and out, dark red on rim. Surface: burnished on red slip. Profile.
118		A 89 A 98	A 2a-c	R: 21.0 cm H: 5.2 cm B: 8.4 cm		Ware: medium coarse buff. Temper: grit and chaff. Slip: orange-red over rim. Surface: burnished on red slip. Profile.
119		A 401	A 1	R: 20.4 cm H: 3.8 cm	A 2c C 1-4	Ware: medium coarse buff. Temper: chaff. Slip: orange-red over rim. Base: missing. Rim sherd.
120		A 19	Topsoil	R: 10.5 cm H: 3.9 cm B: 5.0 cm		Ware: medium coarse buff. Temper: grit and chaff. Slip: orange inside and out, dark red out above carination. Surface: burnished on red slip. Profile.
121		A 58	A 2c-3	R: 10.6 cm H: 3.0 cm	A 2b C 5	Ware: medium coarse orange-buff. Temper: grit and chaff. Slip: bright red over rim. Surface: burnished on red slip and outside. Base: missing. Rim sherd.

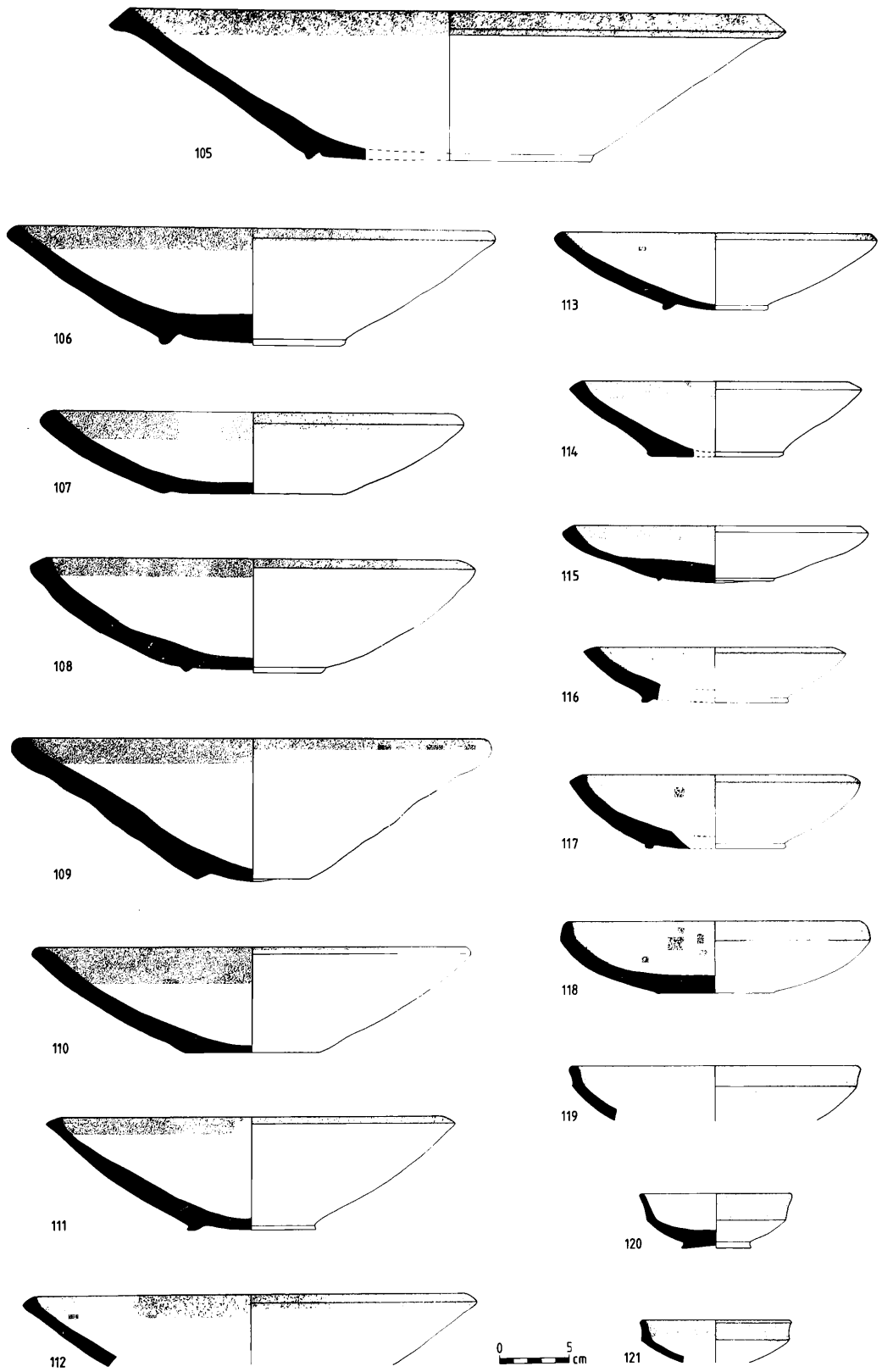

PLATE 35

SHALLOW BOWLS – MIDDLE ASSYRIAN AND MITANNI

Pot No	TR No	Batch	Level	Dimensions	Range	Ware and Remarks
122		A 473	A 1	R: 36.2 cm H: 8.3 cm B: 12.2 cm	A 1-2b C 1-4	Ware: medium coarse red. Temper: grit and chaff. Profile.
123		A 487	A 1	R: 35.8 cm H: 9.0 cm B: 12.0 cm	A 1-2c C 1-5	Ware: medium coarse buff. Temper: grit and chaff. Profile.
124		C 58	C 3	R: 31.5 cm H: 8.4 cm B: 11.7 cm	A 2 C 1-5	Ware: medium coarse orange-buff. Temper: grit and chaff. Profile.
125		A 473	A 1	R: 27.4 cm H: 7.3 cm B: 10.8 cm	A 1 C 2-5	Ware: medium coarse buff to red. Temper: white grit and much chaff. Profile.
126		C 326	C 5	R: 28.5 cm H: 7.7 cm B: 12.4 cm	A 2 C 2-5	Ware: medium coarse pink-buff. Temper: white grit and chaff. Profile.
127		A 471	A 2	R: 25.6 cm H: 5.7 cm B: 11.0 cm	A 1-2c C 2-5	Ware: medium coarse buff with black core in places. Temper: white grit and chaff. Profile.
128		C 531	C 3	R: 26.6 cm H: 6.5 cm B: 11.4 cm	C 5	Ware: medium coarse red with black core in places. Temper: grit and chaff. Slightly warped. Profile.
129		C 532	C 4	R: 32.6 cm H: 8.5 cm B: 12.0 cm	A 1 C 1-4	Ware: medium coarse buff. Temper: grit and chaff. Surface: well smoothed. Profile.
130		C	C 4	R: 36.0 cm H: 9.4 cm B: 11.3 cm	A 1-2a C 1-4	Ware: medium coarse red-buff. Temper: grit and chaff. Profile.
131		A 352	A 2a-b	R: 33.0 cm H: 8.8 cm B: 12.4 cm	A 1-2a C 1-5	Ware: medium coarse buff. Temper: chaff. Profile.
132		C	C 5	R: 28.0 cm H: 5.9 cm B: 13.2 cm	A 2a C 1-6a	Ware: medium coarse buff. Temper: grit and chaff. Profile.
133		C 532	C 4	R: 28.2 cm H: 5.6 cm B: 13.6 cm	A 2 C 1-5	Ware: medium coarse buff with black core in places. Temper: grit and chaff. Profile.
134		A 619	A 2	R: 27.0 cm H: 5.2 cm B: 12.3 cm	A 2 C 1-6a	Ware: medium coarse buff. Temper: grit and chaff. Surface: smoothed inside. Profile.
135		A 263	A 2c-3	R: 28.4 cm H: 6.3 cm B: 12.2 cm	A 2 C 1-5	Ware: medium coarse green. Temper: chaff. Profile.
136		A 457	A 2c	R: 26.4 cm H: 6.0 cm B: 11.5 cm	A 2a C 1-6a	Ware: medium coarse buff. Temper: chaff. Profile.
137	3103	DG 22-66	D 4	R: 26.5 cm H: 5.9 cm B: 13.6 cm	A 1-2b C 2-5	Ware: medium coarse light buff. Temper: grit and chaff. Very warped. Complete.

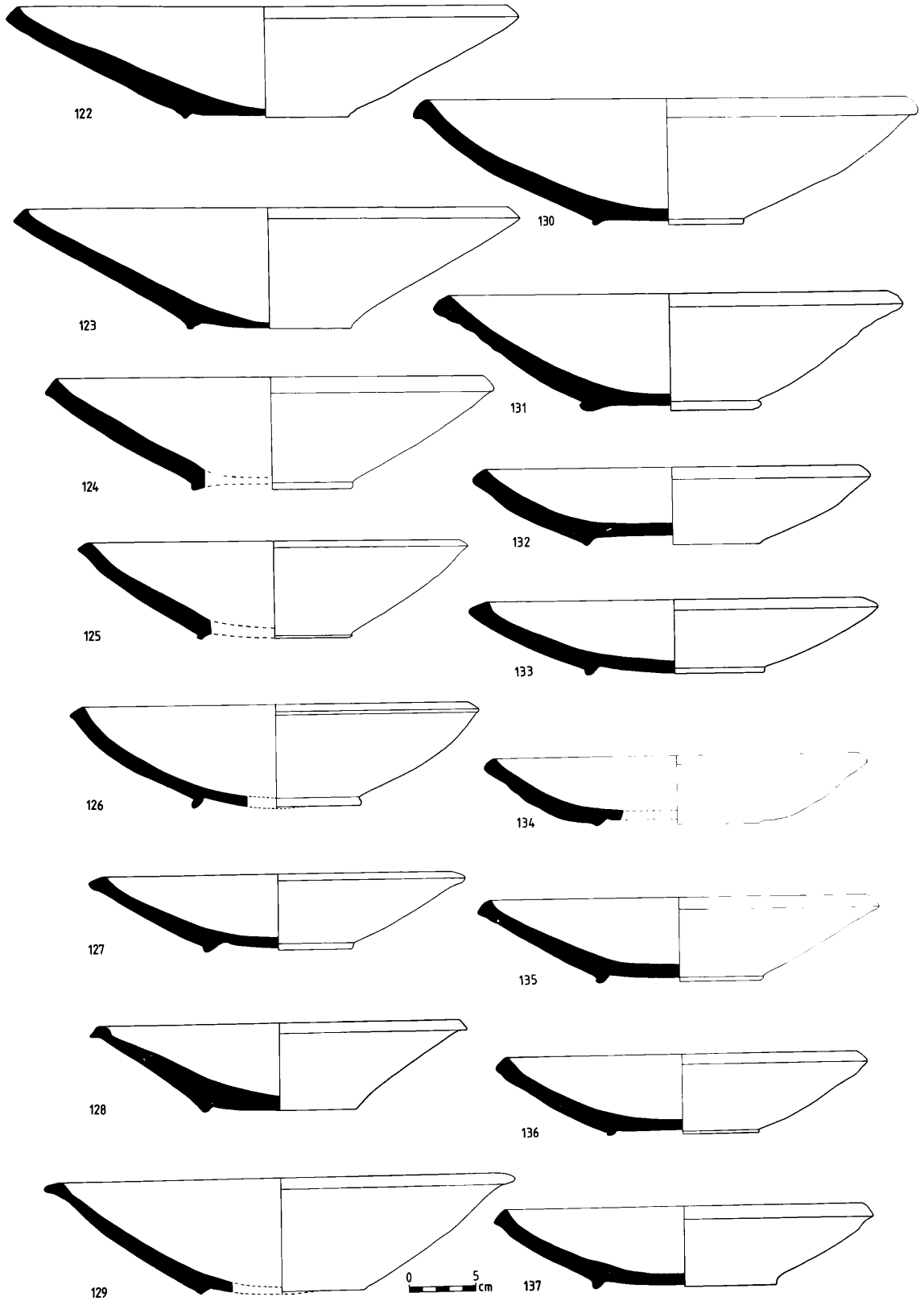
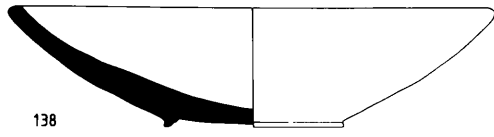

PLATE 36

SHALLOW BOWLS – MIDDLE ASSYRIAN AND MITANNI

Pot No	TR No	Batch	Level	Dimensions	Range	Ware and Remarks
138		D 106	D 4	R: 27.6 cm H: 7.2 cm B: 10.7 cm	A 1-2c C 1-5	Ware: medium coarse red. Temper: grit and chaff. Profile.
139		C 531	C 3	R: 24.4 cm H: 6.7 cm B: 9.6 cm	A 1-2a C 1-4	Ware: medium coarse green. Temper: some large white grit and chaff. Surface: well smoothed inside. Profile.
140		C 81	C 3	R: 23.6 cm H: 7.0 cm B: 10.0 cm	A 2 C 1-5	Ware: medium coarse brown-buff. Temper: large grit and much chaff. Surface: smoothed inside. Profile.
141		C 949	C 1-4	R: 29.4 cm H: 7.8 cm B: 13.4 cm	A 1-2c C 1-5	Ware: medium coarse buff. Temper: some large white grit and chaff. Profile.
142		C 266	C 2	R: 27.0 cm H: 7.2 cm B: 10.5 cm	A 2 C 1-6a	Ware: medium coarse salmon-pink. Temper: grit and chaff. Surface: smoothed inside. Almost complete.
143		A 426	A 2c	R: 28.8 cm H: 7.6 cm B: 11.4 cm		Ware: medium coarse red. Temper: grit and chaff. Profile.
144		A 292	A 2a-b	R: 28.0 cm H: 5.5 cm B: 13.0 cm	A 1 C 1-4	Ware: coarse buff. Temper: chaff. Profile.
145		C 574	C 5	R: 30.0 cm H: 5.8 cm B: 11.0 cm	A 1 C 4-5	Ware: coarse buff to red. Temper: grit and chaff. Surface: well smoothed. Warped. Profile.
146		C	C 4	R: 28.0 cm H: 5.6 cm B: 13.2 cm	C 1-5	Ware: medium coarse buff. Temper: grit and chaff. Profile.
147		C 244	C 5a	R: 23.5 cm H: 5.4 cm B: 9.8 cm	C 1-5	Ware: medium coarse yellow-buff. Temper: chaff. Profile.
148		C 624	C 4-5	R: 24.4 cm H: 7.5 cm B: 9.5 cm	A 1-2c C 1-4	Ware: medium coarse buff. Temper: some large white grit and chaff. Profile.
149		C 302	C 4	R: 18.2 cm H: 4.8 cm B: 7.4 cm	C 1-5	Ware: medium fine buff. Temper: fine grit and chaff. Profile.
150		C 335	C 5b	R: 16.6 cm H: 4.2 cm B: 7.0 cm	C 4-5	Ware: medium coarse buff. Temper: large white grit and chaff. Profile.
151		A 80	A 1-2	R: 20.0 cm H: 4.1 cm B: 8.5 cm	C 3	Ware: medium fine buff. Surface: glaze inside and out, upper part pale blue to white, lower part green to yellow. Profile.
152		C 1	C 4	R: 19.5 cm H: 3.1 cm B: 12.2 cm	C 1-5	Ware: coarse green-buff. Temper: grit and chaff. Very irregular shape. Profile.



138

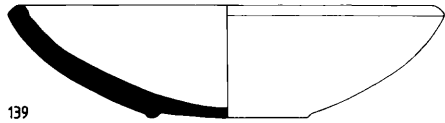

139

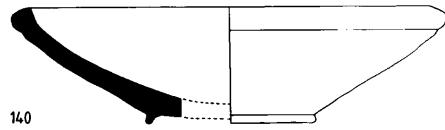

140

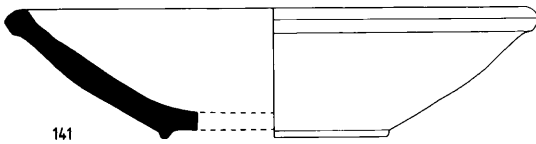

141

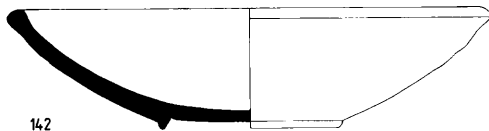

142

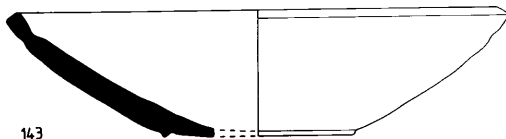

143



144



145



146

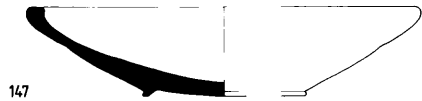

147

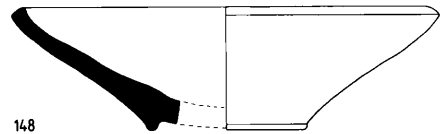

148

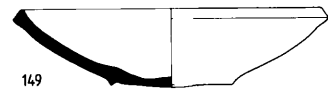

149



150



151



152



PLATE 37

SHALLOW BOWLS – MIDDLE ASSYRIAN AND MITANNI

Pot No	TR No	Batch	Level	Dimensions	Range	Ware and Remarks
153		A 33	A 1	R: 35.0 cm H: 11.0 cm B: 12.0 cm	A 1-2a C 1-6a	Ware: medium coarse pink-buff. Temper: much fine grit and chaff. Base: string-cut. Profile.
154		A 473	A 1	R: 33.6 cm H: 8.3 cm B: 11.6 cm	A 1-2c C 1-5	Ware: medium coarse red. Temper: grit and chaff. Profile.
155		A 473	A 1	R: 34.0 cm H: 7.6 cm B: 15.0 cm	A 1-2a C 1-4	Ware: medium coarse buff. Temper: some large white grit and chaff. Profile.
156	5023	C 209	C 2	R: 30.0 cm H: 7.2 cm B: 11.8 cm	A 1-2 C 1-6a	Ware: medium coarse buff. Temper: grit and chaff. Complete.
157		A 473	A 1	R: 31.0 cm H: 6.8 cm B: 10.6 cm	A 2 C 1-5	Ware: medium coarse red. Temper: some large white grit and chaff. Surface: well smoothed. Profile.
158		A 42	A 1	R: 28.0 cm H: 5.4 cm B: 9.5 cm	A 1-2a C 3-5	Ware: medium coarse buff. Temper: grit and chaff. Profile.
159		A 473	A 1	R: 24.2 cm H: 5.7 cm B: 8.8 cm	C 1-5	Ware: medium coarse buff to cream. Temper: large red grit and chaff. Base: string-cut then smoothed. Profile.
160		C 900	C 5b	R: 23.0 cm H: 5.8 cm B: 10.0 cm	C 2-6a	Ware: coarse buff to red. Temper: grit and chaff. Profile.
161		C	C 3	R: 21.8 cm H: 5.3 cm B: 8.5 cm	C 3-4	Ware: medium coarse buff to pink. Temper: chaff. Profile.
162		C	C 2	R: 21.0 cm H: 5.2 cm B: 9.0 cm	A 2 C 1-4	Ware: medium coarse buff. Temper: chaff. Profile.
163		A 314	A 2	R: 17.0 cm H: 4.4 cm B: 6.7 cm	A 2a C 1-6a	Ware: medium coarse buff. Temper: grit and chaff. Profile.
164		C 905	C 5	R: 19.0 cm H: 5.6 cm B: 9.4 cm	A 2 C 1-4	Ware: medium coarse red. Temper: grit and chaff. Profile.
165	5022	C 226	C 2	R: 18.3 cm H: 4.8 cm B: 8.6 cm		Ware: medium coarse buff. Temper: chaff and some grit. Complete.
166		A 72 A 74 A 88 A 90	A 2a	R: 18.6 cm H: 4.0 cm	C 1-4	Ware: medium coarse buff. Temper: grit and chaff. Very irregular. Base: rounded. Profile.
167	3140	A	A 2	R: 20.6 cm H: 6.0 cm B: 8.6 cm	A 1-2 C 1-5	Ware: medium coarse buff. Temper: grit and chaff. Complete.
168		C 934	C 4-5	R: 19.2 cm H: 5.1 cm	A 1 C 1-4	Ware: medium coarse brown. Temper: grit, chaff. Coating of plaster inside on rounded base. Profile.
169		C	C 3	R: 18.5 cm H: 5.7 cm B: 6.5 cm	A 1-2 C 1-5	Ware: medium coarse buff. Temper: grit and chaff. Profile.
170		A 42	A 1	R: 19.4 cm H: 4.7 cm		Ware: medium fine green. Temper: grit and chaff. Warped. Base: rounded. Almost complete.
171	166	A 72 A 74 A 88 A 90	A 2a	R: 18.5 cm H: 5.6 cm B: 8.2 cm	A 2 C 1-5	Ware: medium coarse buff to orange. Temper: grit and chaff. Complete.
172		A 96	A 1	R: 22.8 cm H: 5.3 cm B: 9.2 cm	C 1-5	Ware: medium coarse buff. Temper: chaff and fine grit. Base: string-cut. Profile.
173		A 332	A 1	R: 19.5 cm H: 4.0 cm B: 7.6 cm	A 2 C 1-5	Ware: coarse buff. Temper: chaff. Profile.
174		C 516	C 2	R: 19.8 cm H: 3.8 cm B: 8.6 cm	A 2 C 1-4	Ware: medium coarse buff. Temper: grit and chaff. Profile.
175		A 490	A 2a	R: 19.0 cm H: 2.3 cm	C 5	Ware: medium fine buff. Temper: grit and chaff. Warped. Base: rounded. Profile.

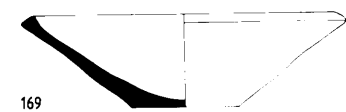
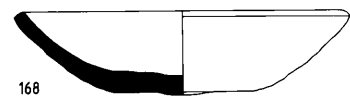
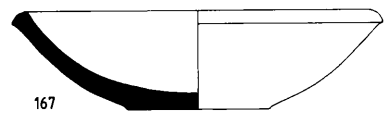
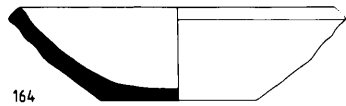
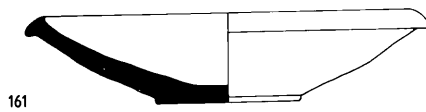
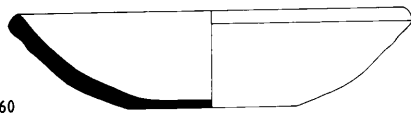
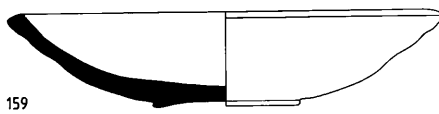
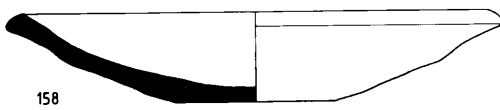
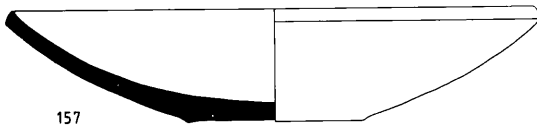
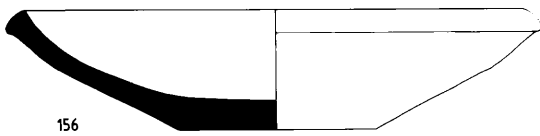
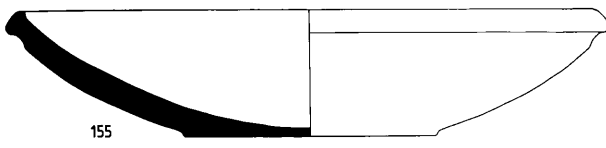
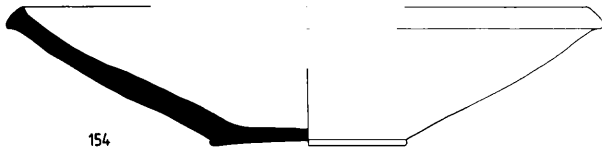
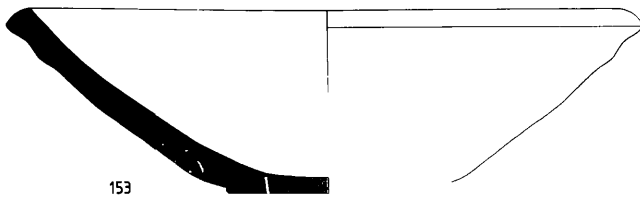

PLATE 38

BOWLS – MIDDLE ASSYRIAN AND MITANNI

Pot No	TR No	Batch	Level	Dimensions	Range	Ware and Remarks
176		A 42	A 1	R: 33.4 cm H: 9.9 cm B: 11.4 cm	A 2-3 C 3-5b	Ware: medium coarse buff. Temper: grit and chaff. Profile.
177		A 42	A 1	R: 32.8 cm H: 10.7 cm B: 10.0 cm	A 3 C 1-5b	Ware: medium coarse buff. Temper: white grit and chaff. Profile.
178		A 473	A 1	R: 31.0 cm H: 9.5 cm B: 12.0 cm	C 1-5	Ware: coarse red. Temper: grit and chaff. Surface: well smoothed. Profile.
179		C 692	C 5	R: 30.8 cm H: 8.2 cm B: 13.6 cm	A 1-3 C 3-6	Ware: medium coarse light buff. Temper: grit and chaff. Surface: burnished inside and out. Profile.
180		C 624	C 4-5	R: 29.6 cm H: 11.4 cm B: 10.0 cm	A 3 C 1-6	Ware: coarse red with black core. Temper: grit and much chaff. Warped. Profile.
181		A 474	A 1	R: 31.0 cm H: 8.7 cm B: 11.6 cm	A 1-3 C 3-5	Ware: medium coarse red. Temper: grit and chaff. Profile.
182		D 106	D 4	R: 27.4 cm H: 9.9 cm B: 12.0 cm	A 3 C 1-6	Ware: medium coarse brown-buff. Temper: grit and chaff. Surface: well smoothed. Profile.
183		C	C 4	R: 23.0 cm H: 7.2 cm B: 9.0 cm	A 1-2c C 1-4	Ware: medium coarse green-buff. Temper: grit and chaff. Profile.
184		A 301	A 1	R: 22.0 cm H: 5.5 cm B: 9.3 cm	A 1 C 1	Ware: medium coarse cream. Temper: grit and chaff. Profile.
185		A 241	A 1	R: 25.4 cm H: 7.2 cm B: 10.5 cm	A 2b C 3-4	Ware: medium coarse light buff. Temper: chaff. Profile.
186		A 281	A 1	R: 33.4 cm H: 10.2 cm B: 11.0 cm	A 1-2c C 2-5	Ware: medium coarse buff. Temper: grit and chaff. Profile.
187		A 301	A 1	R: 36.0 cm H: 11.0 cm B: 12.2 cm	A 1 C 4	Ware: medium coarse cream. Temper: grit and chaff. Profile.
188		A 287	A 1	R: 32.0 cm H: 10.1 cm B: 13.2 cm	A 1	Ware: medium coarse green. Temper: grit and chaff. Profile.
189		A 233	A 1	R: 35.0 cm H: 12.7 cm B: 10.5 cm	A 2a-3 C 4	Ware: medium coarse light buff. Temper: grit and chaff. Profile.

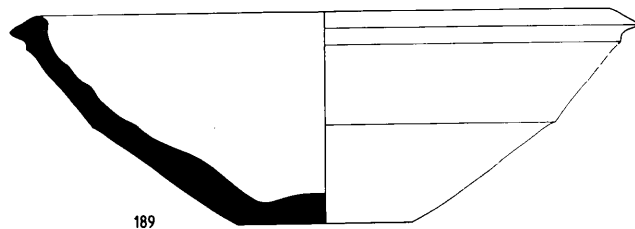
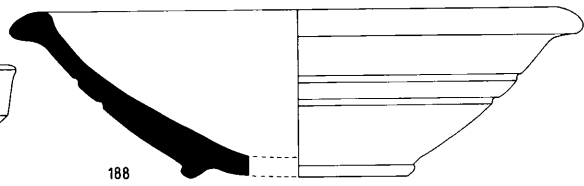
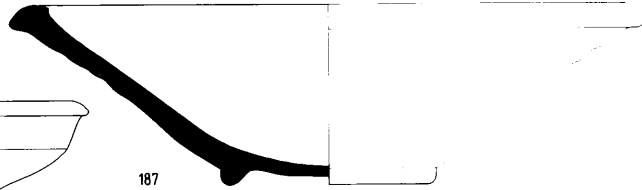
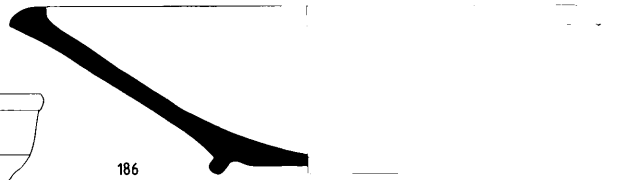
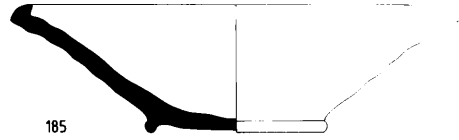
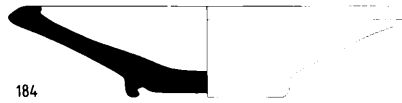
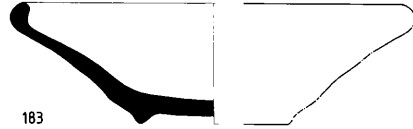
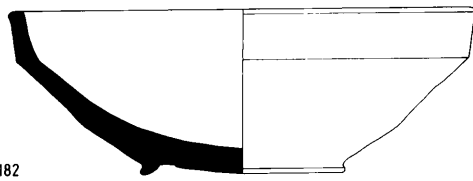
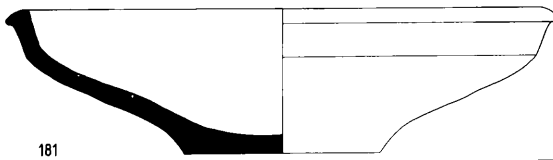
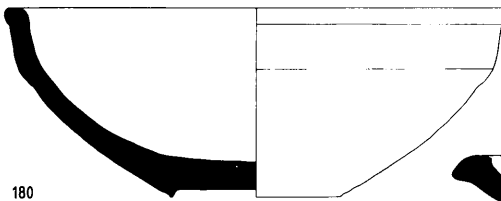
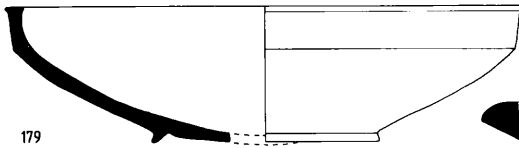
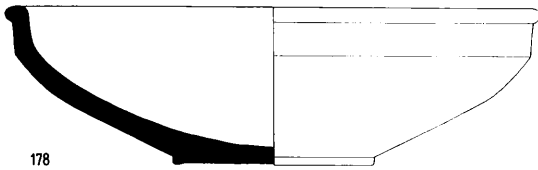
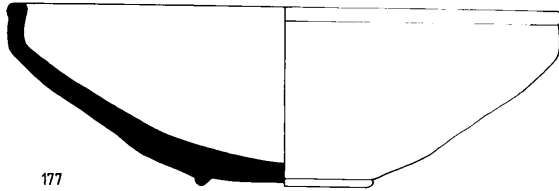
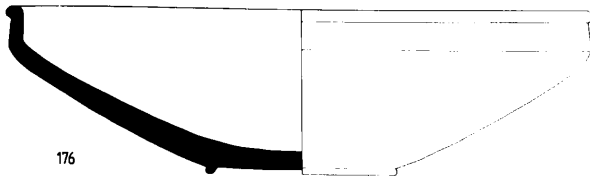

PLATE 39

BOWLS – MIDDLE ASSYRIAN AND MITANNI

Pot No	TR No	Batch	Level	Dimensions	Range	Ware and Remarks
190		C 58	C 3	R: 47.0 cm H: 17.2 cm B: 13.6 cm	A 1-2a C 1-4	Ware: medium coarse orange-buff. Temper: grit and chaff. Surface: originally there was a thick layer of plaster inside and out. Profile.
191	2114	A 352	A 2a-b	R: 41.4 cm H: 18.4 cm B: 11.0 cm	C 1-5	Ware: medium coarse light buff. Temper: grit and chaff. Complete.
192		A 353	A 1	R: 35.0 cm H: 12.8 cm B: 10.8 cm	A 1-2c C 1-6	Ware: medium coarse orange-buff. Temper: grit and chaff. Profile.
193		D 28	D 3	R: 31.8 cm H: 12.6 cm B: 10.6 cm	A 1 C 1-4	Ware: medium coarse buff. Temper: grit and chaff. Profile.
194		A 487	A 1	R: 25.0 cm H: 9.0 cm B: 11.2 cm	A 2c C 2-5	Ware: medium coarse buff. Temper: grit and chaff. Surface: plaster lining inside. Profile.
195		A 477	A 3 late	R: 26.4 cm H: 7.2 cm B: 13.0 cm	C 3-5	Ware: medium coarse buff. Temper: some large white grit and chaff. Profile.
196		A 735	A 3	R: 22.0 cm H: 10.0 cm B: 11.3 cm		Ware: medium coarse yellow-buff. Temper: grit and some chaff. Profile.
197		C 546	C 5b	R: 28.0 cm H: 10.0 cm B: 12.2 cm	C 4	Ware: medium fine pale red. Temper: grit and chaff. Surface: well smoothed. Profile.
198		A 290	A 1	R: 28.0 cm H: 12.0 cm B: 10.0 cm		Ware: coarse buff. Temper: much chaff. Surface: much burning inside. Profile.
199		A 337	A 2	R: 31.0 cm H: 11.2 cm B: 12.8 cm	C 3-6a	Ware: coarse pink-buff. Temper: grit and chaff. Profile.
200		A 357	A 1	R: 32.0 cm H: 13.5 cm B: 15.0 cm	C 5	Ware: medium coarse light buff. Temper: grit and chaff. Profile.

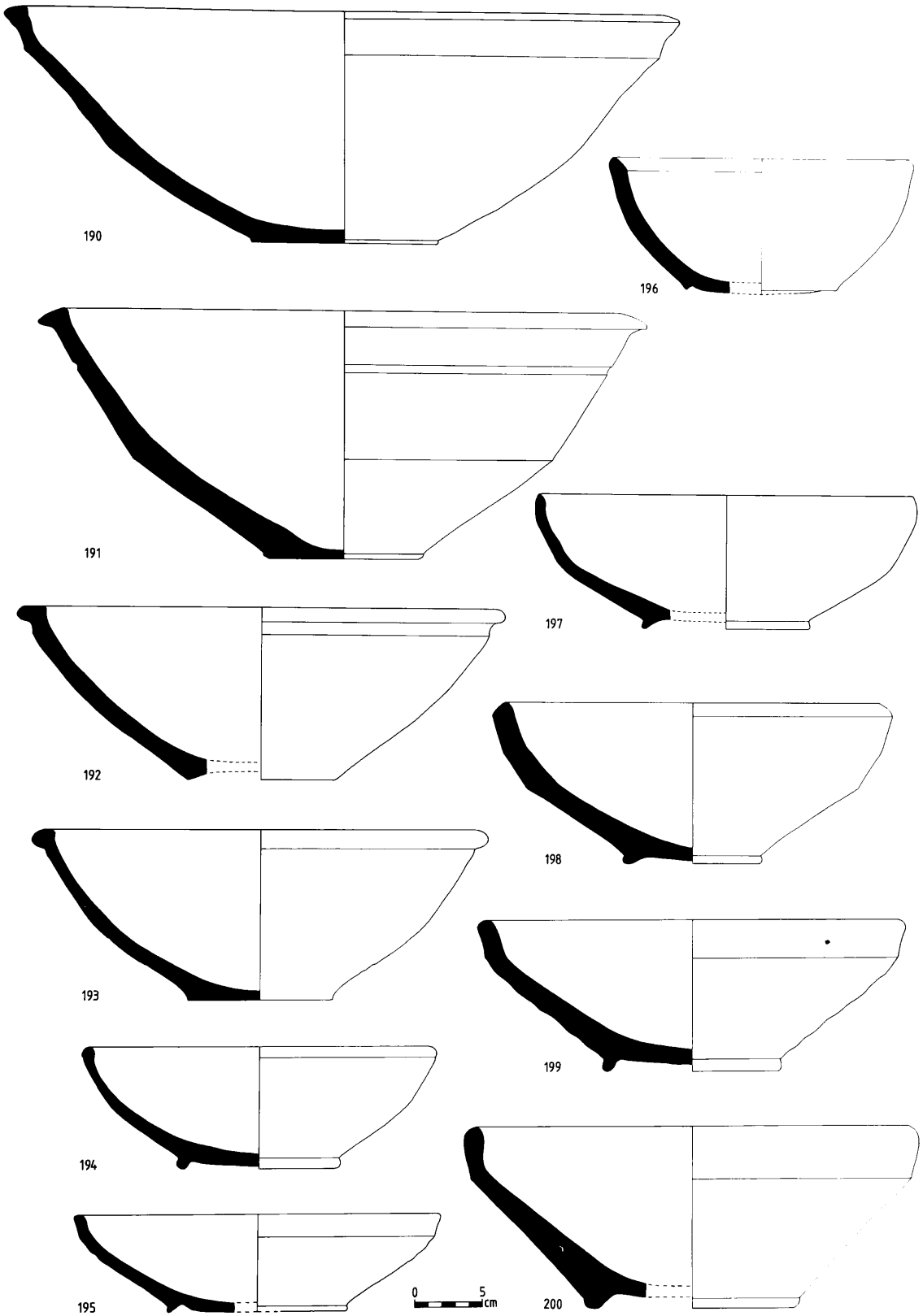

PLATE 40

BURNISHED BOWLS – MITANNI AND OLD BABYLONIAN

Pot No	TR No	Batch	Level	Dimensions	Range	Ware and Remarks
201		A 406	A 2c-3	R: 39.3 cm H: 10.5 cm B: 16.0 cm	A 1-3 C 1-6a	Ware: medium fine grey. Temper: grit and chaff. Surface: burnished inside and out. Profile.
202		A 471	A 2	R: 28.8 cm H: 7.3 cm B: 17.0 cm	A 2c C 1-6a	Ware: medium coarse green. Temper: grit and chaff. Profile.
203		C 81	C 3	R: 25.0 cm H: 7.0 cm B: 12.0 cm	A 3 C 2-6a	Ware: medium fine grey. Temper: small white grit and chaff. Surface: highly burnished inside and out. Profile.
204		C 359	C 4	R: 26.8 cm H: 5.8 cm B: 12.2 cm	C 3-5	Ware: medium coarse buff. Temper: grit and chaff. Surface: smoothed inside and out. Profile.
205		D 91	D 3	R: 23.5 cm H: 7.6 cm B: 8.7 cm	C 3-6	Ware: coarse grey-green. Temper: grit and chaff. Irregular. Profile.
206		C 372	C 5b	R: 23.4 cm H: 7.2 cm B: 13.5 cm	A 2-3 C 3-6a	Ware: medium fine green, overfired. Temper: white grit and chaff. Surface: smoothed. Profile.
207		C 940	C 4-5	R: 21.2 cm H: 5.3 cm B: 10.0 cm	C 5-6a	Ware: medium coarse green. Temper: grit and chaff. Profile.
208		C 698	C 5	R: 24.2 cm H: 5.6 cm B: 13.0 cm		Ware: medium coarse green. Temper: grit and chaff. Profile.
209		C 48	C 5	R: 21.5 cm H: 6.1 cm B: 9.2 cm	A 1 C 5-6a	Ware: medium coarse light green. Temper: grit and chaff. Surface: smoothed. Profile.
210		C 48	C 5	R: 24.0 cm H: 7.5 cm B: 11.8 cm	C 5	Ware: medium coarse grey. Temper: white grit and chaff. Surface: burnished inside and out. Profile.
211		A 614	A 3	R: 21.8 cm H: 5.5 cm B: 15.0 cm		Ware: medium coarse salmon-pink to white. Temper: grit and chaff. Profile.
212		A 484	A 3	R: 30.2 cm H: 6.9 cm B: 16.8 cm	C 5	Ware: medium coarse pink-buff. Temper: chaff. Surface: well smoothed. Profile.

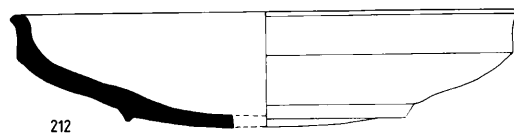
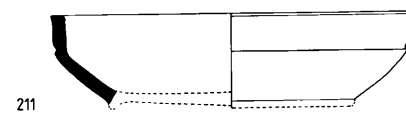
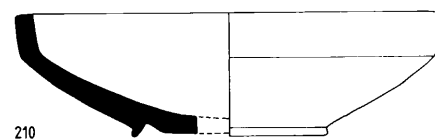
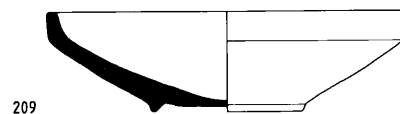
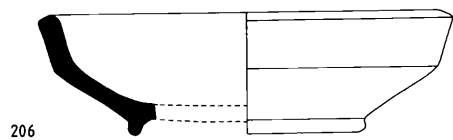
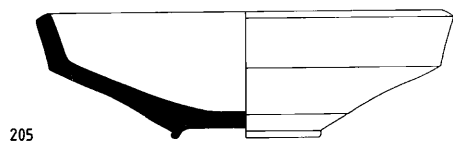
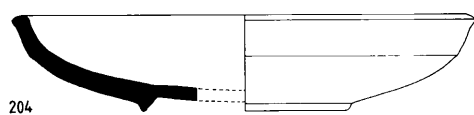
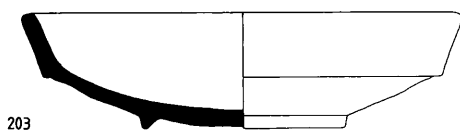
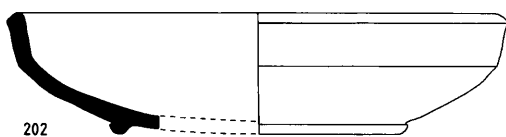
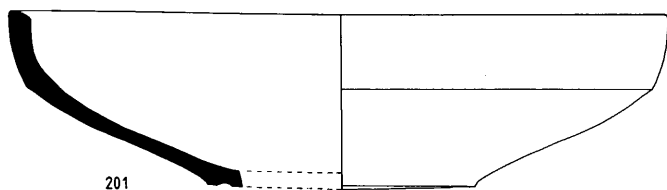

PLATE 41

BURNISHED BOWLS – OLD BABYLONIAN

Pot No	TR No	Batch	Level	Dimensions	Range	Ware and Remarks
213		C 36	C 6a	R: 29.6 cm H: 7.8 cm	A 3 C 6a	Ware: medium fine black with grey core. Temper: grit and chaff. Surface: highly burnished inside and out. Base: missing. Rim sherd.
214		A 565	A 3	R: 21.8 cm H: 8.1 cm B: 9.4 cm	A 3	Ware: medium coarse black with grey core. Temper: grit and chaff. Surface: highly burnished inside and out. Profile.
215		A 611	A 2-3	R: 29.0 cm H: 8.3 cm B: 12.6 cm	A 3 C 5-6	Ware: fine black with grey core. Temper: white grit. Surface: highly burnished inside and out. Profile.
216		C 674 C 679 C 686	C 6a	R: 20.0 cm H: 5.7 cm B: 10.2 cm	A 2-3 C 6a	Ware: medium coarse grey. Temper: some large white grit and chaff. Surface: burnished outside and in to carination. Profile.
217		A 565	A 3	R: 18.0 cm H: 6.2 cm B: 9.0 cm	A 1-3 C 3-6	Ware: fine black with grey core. Temper: grit. Surface: highly burnished inside and out. Profile.
218	3109	A 462	A 3 late	R: 13.2 cm H: 4.1 cm B: 3.6 cm		Ware: fine grey. Temper: grit and chaff. Surface: burnished inside and out. Complete.
219		A 599	A 3	R: 16.2 cm H: 5.0 cm B: 4.8 cm	A 3	Ware: fine pale buff. Temper: white grit and a little chaff. Profile.
220		C 14	C 5	R: 16.6 cm H: 5.1 cm B: 5.8 cm	C 5	Ware: medium fine light grey. Temper: grit and chaff. Surface: smoothed. Profile.
221	2140	C	C 4	R: 14.6 cm H: 5.5 cm B: 7.2 cm	A 2-3 C 4-6	Ware: medium fine brittle black. Temper: grit and chaff. Surface: highly burnished inside and out. Almost complete.
222		A 45	A 3 late	R: 16.0 cm H: 4.8 cm B: 6.0 cm	C 5	Ware: fine red to buff. Temper: grit and chaff. Well finished. Profile.
223		D	D ?	R: 13.0 cm H: 4.4 cm B: 4.0 cm	C 5	Ware: medium fine grey. Temper: grit and chaff. Surface: lightly burnished inside and out. Profile.
224		C 349	C 5	R: 13.8 cm H: 4.5 cm B: 5.8 cm	C 5	Ware: medium fine red. Temper: grit. Surface: burnished inside and out. Profile.
225		C 942	C 6a	R: 17.0 cm H: 6.3 cm B: 7.8 cm	A 3 C 5	Ware: medium fine grey. Temper: grit and chaff. Surface: well burnished inside and out. Profile.
226		A 556	A 3	R: 17.6 cm H: 4.9 cm B: 7.0 cm	A 2-3 C 5-6a	Ware: medium coarse light buff. Temper: grit and chaff. Surface: lightly burnished in and out. Profile.
227		A 735	A 3	R: 13.2 cm H: 4.4 cm B: 5.5 cm	A 2-3 C 6a-6	Ware: fine dark grey. Temper: grit and chaff. Surface: traces of burnishing out. Profile.
228		A	A 4	R: 17.0 cm H: 6.1 cm B: 6.0 cm	A 1-3 C 1-6	Ware: medium fine grey. Temper: grit and chaff. Base: string-cut then turned. Surface: burnished inside and out. Profile.

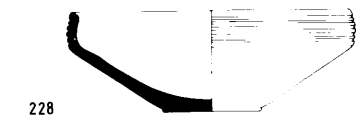
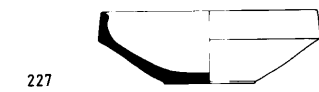
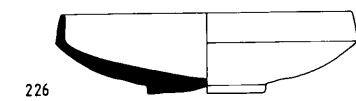
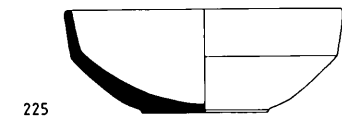
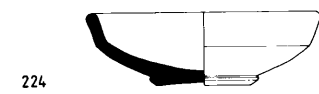
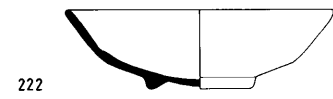
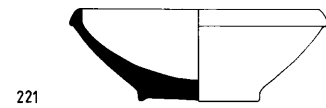
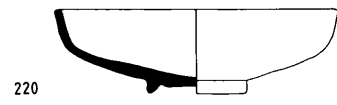
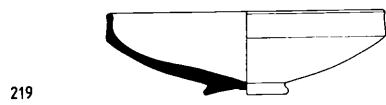
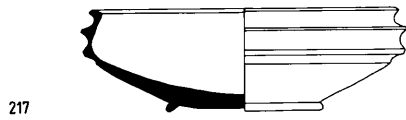
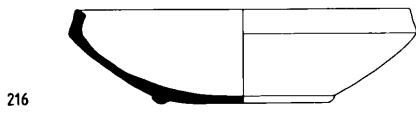
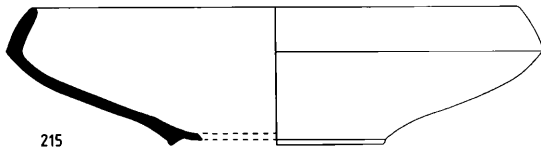
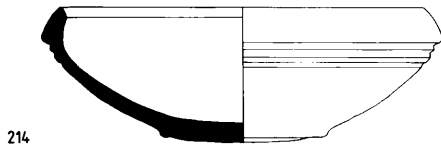
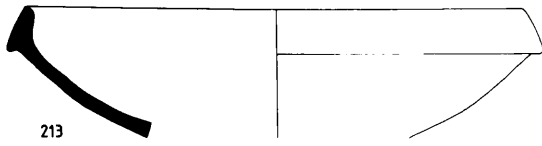

PLATE 42

BOWLS – OLD BABYLONIAN

Pot No	TR No	Batch	Level	Dimensions	Range	Ware and Remarks
229		A 565	A 3	R: 29.4 cm H: 12.0 cm B: 13.0 cm		Ware: very coarse red-buff. Temper: grit and chaff. Base: rough string-cut. Profile.
230		A 452	A 3 late	R: 28.8 cm H: 9.6 cm B: 14.0 cm	C 1-6	Ware: medium coarse buff, fired red and green in places. Temper: grit and chaff. Surface: well smoothed. Profile.
231		A	A 3	R: 28.0 cm H: 11.3 cm B: 11.5 cm		Ware: coarse pink-buff. Temper: grit and chaff. Profile.
232		A 551	A 3 late	R: 25.6 cm H: 8.4 cm B: 12.4 cm		Ware: medium coarse buff. Temper: grit and chaff. Profile.
233		A 568	A 3	R: 27.0 cm H: 8.9 cm B: 11.0 cm		Ware: coarse buff-brown. Temper: grit and chaff. Profile.
234		A 412	A 3 late	R: 28.6 cm H: 11.5 cm B: 10.0 cm	A 2a-3 C 6a	Ware: coarse red. Temper: grit and chaff. Surface: well smoothed. Profile.
235		C 46	C 6	R: 23.8 cm H: 10.4 cm B: 8.8 cm	C 3-6	Ware: medium coarse buff to orange. Temper: grit and chaff. Profile.
236		A 388	A 3	R: 21.2 cm H: 10.0 cm B: 7.6 cm		Ware: medium coarse red. Temper: grit and chaff. Surface: well smoothed. Profile.
237		A 631	A 4	R: 18.8 cm H: 7.3 cm B: 11.2 cm	C 5-6	Ware: medium coarse buff. Temper: some white grit and chaff. Surface: well smoothed. Profile.
238		C 78	C 6	R: 25.4 cm H: 11.2 cm B: 11.0 cm	A 3 C 4-6a	Ware: medium coarse orange-buff. Temper: white grit and chaff. Surface: smoothed. Profile.
239		A 599	A 3	R: 25.0 cm H: 10.1 cm B: 11.0 cm	C 5-6	Ware: medium coarse red-buff. Temper: grit and chaff. Profile.
240		A 599	A 3	R: 23.6 cm H: 8.4 cm B: 10.0 cm	C 4-6a	Ware: medium coarse pink to white. Temper: grit and chaff. Profile.
241		A 498	A 3	R: 24.0 cm H: 9.7 cm B: 12.8 cm	C 5	Ware: medium coarse red. Temper: grit and chaff. Surface: well smoothed. Profile.

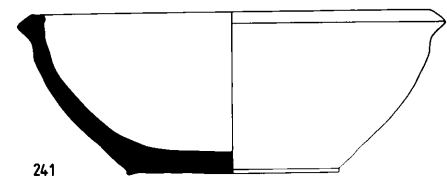
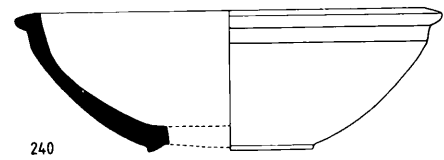
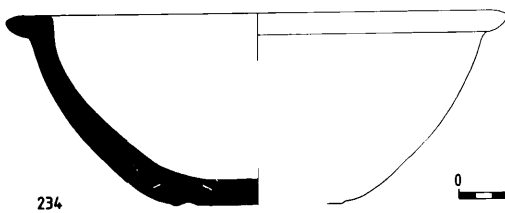
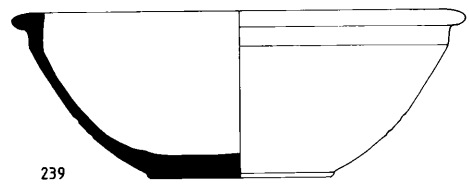
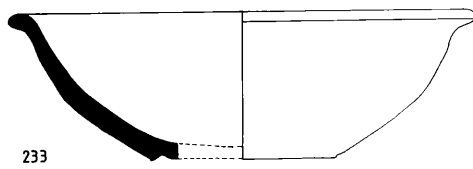
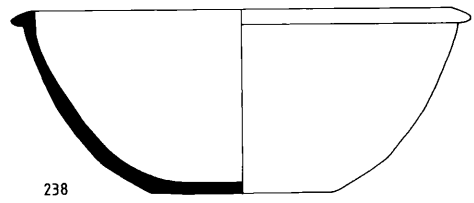
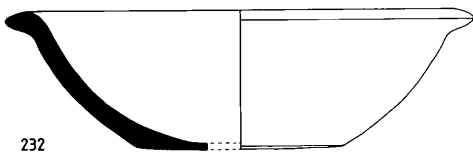
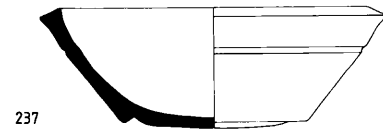
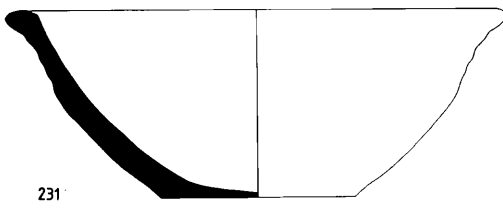
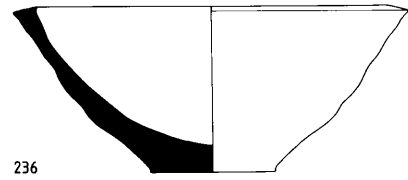
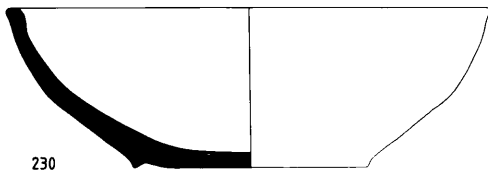
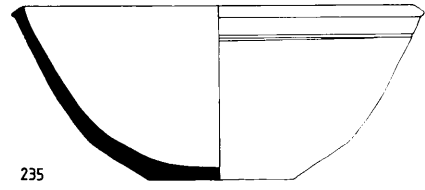
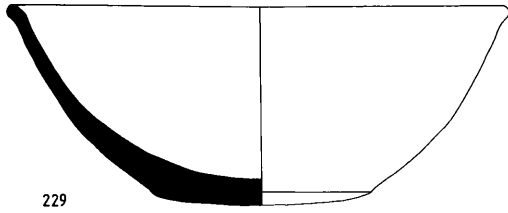

PLATE 43

BOWLS – MITANNI AND OLD BABYLONIAN

Pot No	TR No	Batch	Level	Dimensions	Range	Ware and Remarks
242		C 370	C 5a	R: 37.2 cm H: 8.2 cm B: 16.7 cm	C 5-6	Ware: medium coarse cream to pink with black core. Temper: grit and chaff. Surface: burnished inside and out. Profile.
243		C 349	C 5b	R: 27.6 cm H: 7.7 cm B: 12.6 cm	C 4-6a	Ware: medium coarse white to pink. Temper: fine grit and some chaff. Surface: very smooth inside. Profile.
244		C 369	C 6a	R: 26.4 cm H: 8.1 cm B: 13.0 cm	C 4-5	Ware: medium coarse buff to white. Temper: chaff. Profile.
245		A 477	A 3 late	R: 27.8 cm H: 8.8 cm B: 13.0 cm	C 6a	Ware: medium coarse pink-buff. Temper: grit and chaff. Profile.
246		A 613	A 3	R: 30.0 cm H: 11.0 cm B: 9.6 cm	C 5-6a	Ware: medium coarse salmon-pink. Temper: grit and chaff. Profile.
247		C 676	C 5b	R: 23.0 cm H: 9.1 cm B: 12.0 cm	A 1-3 C 6a-6	Ware: medium coarse buff. Temper: some large white grit and chaff. Surface: well smoothed. Profile.
248		A 337	A 2	R: 24.0 cm H: 8.8 cm B: 9.6 cm	A 3 C 6	Ware: medium coarse buff. Temper: grit and chaff. Profile.
249		A 719	A 3	R: 22.2 cm H: 8.2 cm B: 9.3 cm	A 2c-3 C 6a-6	Ware: coarse green. Temper: grit and chaff. Overfired and warped. Profile.
250		A 735	A 3	R: 24.0 cm H: 8.2 cm B: 11.2 cm	A 2a	Ware: coarse buff. Temper: grit and chaff. Profile.
251		A 646	A 3	R: 22.0 cm H: 5.7 cm B: 11.0 cm		Ware: medium coarse brick-red to white. Temper: grit and chaff. Profile.
252		C 344	C 7	R: 35.6 cm H: 9.5 cm B: 14.8 cm	C 5	Ware: medium fine buff to pink. Temper: grit and chaff. Surface: burnished outside, on rim and inside for 4 cm. Profile.
253		A 599	A 3	R: 41.0 cm H: 13.0 cm B: 19.0 cm	C 5-6	Ware: medium fine pink to white. Temper: white grit and some chaff. Profile.

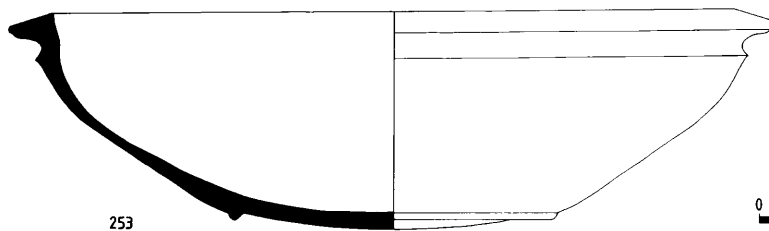
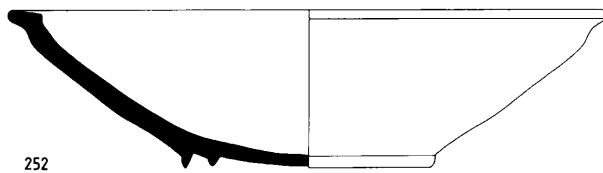
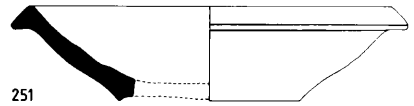
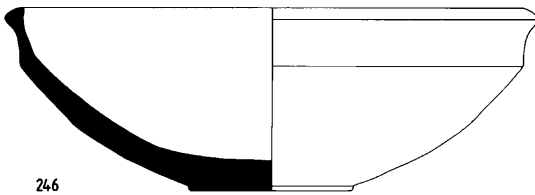
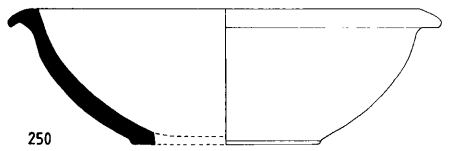
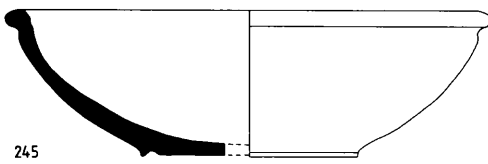
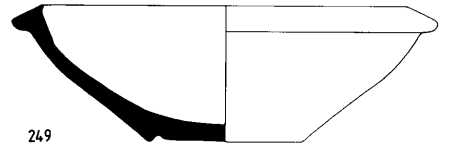
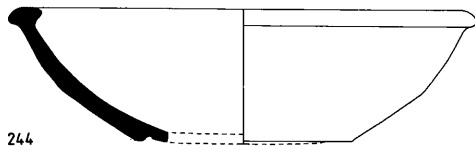
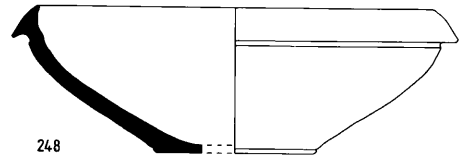
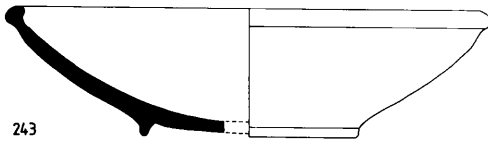
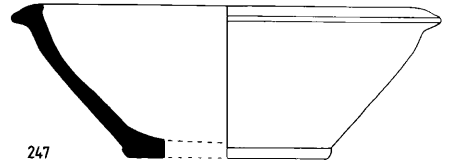
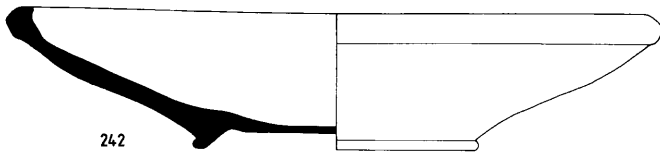

PLATE 44

BURNISHED BOWLS – OLD BABYLONIAN

Pot No	TR No	Batch	Level	Dimensions	Range	Ware and Remarks
254		A 570	A 2c	R: 25.6 cm H: 6.4 cm B: 8.0 cm	A 2c-3 C 6a	Ware: coarse pink-buff. Temper: grit and chaff. Surface: well smoothed. Handmade. Profile.
255		C 679 C 686	C 6a	R: 25.4 cm H: 5.7 cm B: 14.6 cm	A 3 C 5-6	Ware: medium coarse buff to white. Temper: few large white grits and chaff. Surface: burnished outside from base to rim and inside to carination. Handmade. Profile.
256		A 565	A 3	R: 29.6 cm H: 5.8 cm B: 19.5 cm	A 3 C 6a	Ware: medium coarse orange. Temper: grit and chaff. Surface: burnished inside and out. Handmade. Profile.
257		C 435	C 6a	R: 21.5 cm H: 5.0 cm B: 11.4 cm	A 3 C 5-6	Ware: medium coarse cream. Temper: chaff. Handmade. Profile.
258		A 449	A 3 late	R: 25.8 cm H: 7.0 cm B: 10.7 cm	A 2c-3 C 5-7	Ware: medium coarse pink-buff. Temper: chaff. Handmade. Profile.
259		C 369	C 6a	R: 23.5 cm H: 5.4 cm B: 12.4 cm	A 3	Ware: medium fine light cream. Temper: chaff. Surface: burnished inside and out. Handmade. Profile.
260		C 411	C 6	R: 23.5 cm H: 5.9 cm B: 12.6 cm	A 3 C 5b	Ware: medium coarse grey. Temper: chaff. Surface: burnished inside and out. Handmade. Profile.
261		A 584	A 3	R: 23.5 cm H: 5.8 cm B: 11.8 cm	A 3 C 4-5	Ware: medium coarse grey. Temper: chaff. Surface: burnished inside and out. Handmade. Profile.
262		A 565	A 3	R: 24.0 cm H: 5.5 cm B: 17.0 cm	A 3 C 5-6	Ware: medium coarse black to brown. Temper: grit and chaff. Surface: burnished inside and out. Handmade. Profile.
263		C 948	C 6a	R: 26.5 cm H: 5.9 cm B: 18.0 cm	A 1-3 C 6a-6	Ware: medium coarse grey. Temper: grit and chaff. Surface: burnished inside and out. Handmade. Profile.
264	4110	C 28	C 5b-6a	R: 20.0 cm H: 5.2 cm B: 12.3 cm	A 3 C 5-6	Ware: medium coarse pink to white. Temper: grit and chaff. Surface: very well smoothed. Handmade. Base: concave low ring. Complete.
265		A 637	A 3	R: 25.5 cm H: 5.2 cm B: 16.6 cm	A 3 C 6	Ware: medium fine grey. Temper: grit and some chaff. Surface: burnished inside and out. Handmade. Profile.
266		A 637	A 3	R: 28.8 cm H: 5.3 cm B: 17.4 cm	A 3 C 6a-6	Ware: medium fine grey. Temper: grit and chaff. Surface: burnished inside and out. Handmade. Profile.

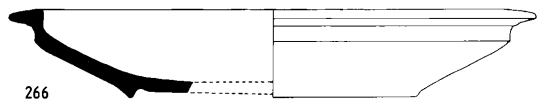
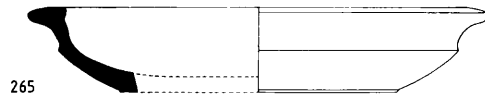
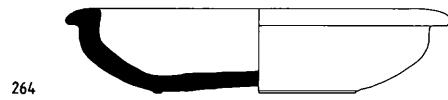
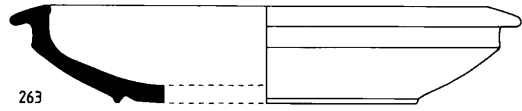
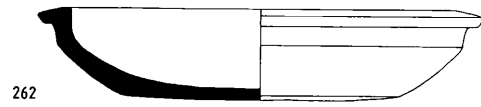
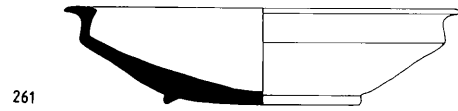
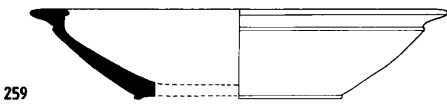
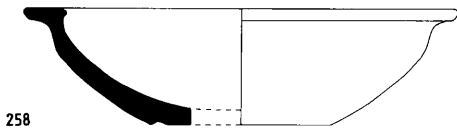
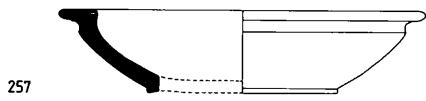
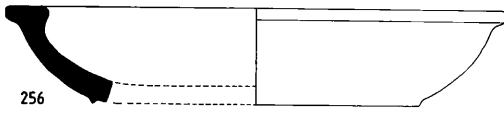
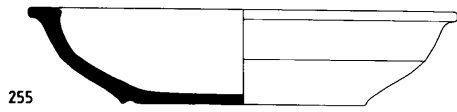
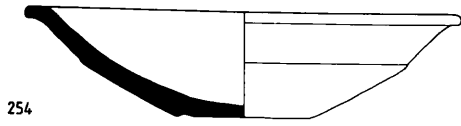

PLATE 45

BURNISHED BOWLS – OLD BABYLONIAN

Pot No	TR No	Batch	Level	Dimensions	Range	Ware and Remarks
267		C 561	C 7	R: 29.0 cm H: 5.7 cm B: 12.6 cm	A 3	Ware: medium coarse yellow. Temper: grit and chaff. Profile.
268		C 82	C 5b	R: 24.5 cm H: 5.2 cm B: 13.5 cm	A 3 C 5	Ware: coarse brown-buff. Temper: grit and chaff. Surface: burnished inside and out. Profile.
269		A 584	A 3	R: 23.8 cm H: 5.2 cm B: 13.5 cm	C 6	Ware: medium coarse buff to white. Temper: grit and chaff. Surface: well smoothed. Profile.
270		A 314	A 2	R: 16.0 cm H: 4.1 cm B: 7.6 cm	A 3	Ware: medium coarse grey. Temper: chaff. Surface: burnished inside and out. Profile.
271		C 674 C 679	C 6a	R: 24.4 cm H: 5.3 cm B: 15.0 cm	A 3 C 6a-6	Ware: medium coarse red to cream. Temper: several large white grits and chaff. Surface: burnished from base to rim outside and inside to carination. Handmade. Profile.
272		C 928	C 6a	R: 23.0 cm H: 5.4 cm B: 15.0 cm	C 6a -6	Ware: medium coarse green. Temper: grit and chaff. Surface: lightly burnished inside and out. Handmade. Profile.
273		C 679 C 686	C 6a	R: 23.6 cm H: 6.0 cm B: 13.0 cm	A 3 C 5-6	Ware: medium coarse red to cream. Temper: some large white grit and chaff. Surface: well smoothed. Handmade. Profile.
274		C 699	C 5b	R: 21.4 cm H: 3.9 cm B: 13.6 cm	A 3	Ware: medium coarse red to white. Temper: grit and chaff. Surface: well burnished inside and out. Handmade. Profile.
275		C 419	C 6a	R: 22.0 cm H: 5.8 cm B: 13.0 cm	C 4-5	Ware: coarse light green. Temper: chaff. Warped. Handmade. Profile.
276	6036	C 686	C 6a	R: 23.5 cm H: 5.2 cm B: 14.0 cm	A 3 C 6a	Ware: medium coarse green. Temper: few large white grits and chaff. Surface: smoothed inside and out. Handmade. Complete.
277		A 599	A 3	R: 24.4 cm H: 6.3 cm B: 12.6 cm	C 5-6	Ware: medium coarse yellow to white. Temper: grit and chaff. Handmade. Profile.
278		C 696	C 6a	R: 31.6 cm H: 5.7 cm B: 18.0 cm	A 3 C 5-6	Ware: medium coarse grey. Temper: grit and chaff. Surface: burnished inside and out. Handmade. Profile.
279		A 406	A 2c-3	R: 27.0 cm H: 6.0 cm B: 11.4 cm	A 1-3 C 4-6	Ware: medium fine grey. Temper: white grit and chaff. Surface: burnished inside and out. Handmade. Profile.
280		A 565	A 3	R: 30.0 cm H: 5.7 cm B: 13.5 cm	A 1-3 C 2-6a	Ware: medium coarse green to white. Temper: grit and chaff. Surface: lightly burnished. Handmade. Profile.
281		C 674 C 679 C 686	C 6a	R: 27.6 cm H: 5.9 cm B: 12.4 cm	A 1-3 C 5-6a	Ware: medium coarse black to brown. Temper: some large white grit and chaff. Surface: highly burnished inside and out. Handmade. Profile.
282		A 715	A 3	R: 29.5 cm H: 6.5 cm B: 14.8 cm	A 2c-3 C 6	Ware: medium fine salmon-pink to white. Temper: grit and chaff. Surface: lightly burnished inside and out. Handmade. Profile.

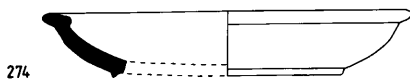
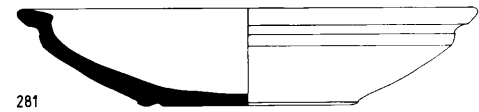
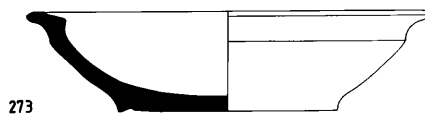
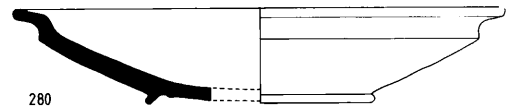
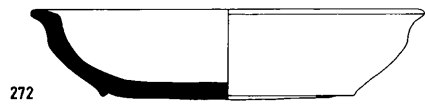
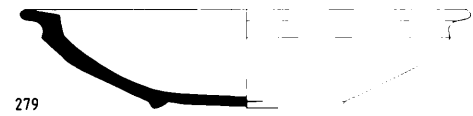
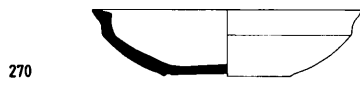
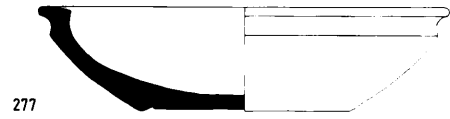
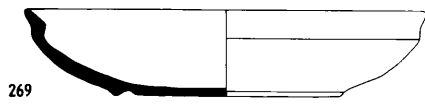
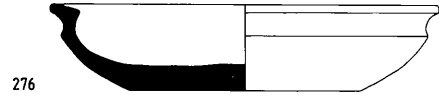
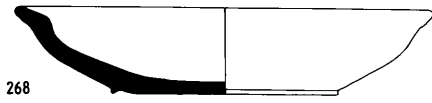
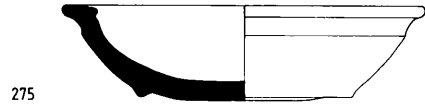
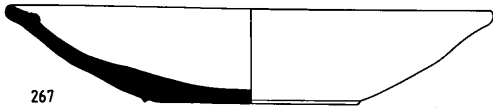

PLATE 46

BURNISHED BOWLS – OLD BABYLONIAN

Pot No	TR No	Batch	Level	Dimensions	Range	Ware and Remarks
283		C 718	C 1-2	R: 33.0 cm H: 3.6 cm B: 35.0 cm	C 6	Ware: medium coarse red. Temper: grit and chaff. Base: rough and uneven. Surface: smoothed inside. One lug extant on part of a round tray. Handmade. Profile.
284		D 144	D 4	R: 29.5 cm H: 1.9 cm B: 27.4 cm		Ware: coarse brown cooking ware with black core. Temper: white grit. Surface: burnished inside and out. Handmade. Profile.
285	5044	C 345 C 347	C 6a	R: 35.0 cm H: 3.4 cm B: 32.3 cm		Ware: coarse brown cooking ware with black core. Temper: white grit. Surface: burnished lightly inside, on rim and outside for 6 cm. Handmade. Half extant.
286		A 565	A 3	R: 35.3 cm H: 6.1 cm B: 28.6 cm		Ware: medium fine black with grey core. Temper: grit and chaff. Surface: burnished inside and out. Handmade. Profile.
287		C 445	C 6	R: 39.6 cm H: 4.0 cm B: 32.0 cm		Ware: medium coarse grey. Temper: grit and chaff. Surface: burnished inside and out. Handmade. Profile.
288		A 565	A 3	R: 43.0 cm H: 6.0 cm B: 36.6 cm		Ware: medium coarse black with grey core. Temper: grit and chaff. Surface: burnished inside and out. Handmade. Profile.
289		A 600	A 3	R: 42.0 cm H: 4.6 cm B: 35.0 cm		Ware: medium coarse orange-brown. Temper: large white grit and chaff. Surface: lightly burnished. Handmade. Profile.
290		A 565	A 3	R: 33.0 cm H: 6.1 cm B: 23.8 cm	A 2-3 C 6a-6	Ware: medium fine black with grey core. Temper: grit and chaff. Surface: burnished inside and out. Handmade. Profile.
291		C 344	C 7	R: 31.0 cm H: 5.0 cm B: 22.5 cm	C 5-6	Ware: medium fine black. Temper: white grit and chaff. Surface: burnished inside and out. Handmade. Profile.
292		A 720	A 3 late	R: 31.4 cm H: 5.6 cm B: 26.6 cm	C 6	Ware: medium coarse orange. Temper: grit and chaff. Handmade. Profile.
293		C 78	C 6	R: 30.0 cm H: 4.8 cm B: 22.0 cm	A 2a C 5-6	Ware: medium coarse grey. Temper: white grit and chaff. Surface: lightly burnished inside and out. Handmade. Profile.
294		A 737	A 3	R: 33.0 cm H: 7.0 cm	A 2c C 6a	Ware: medium coarse black to brown. Temper: grit and chaff. Surface: highly burnished inside and out. Handmade. Profile.

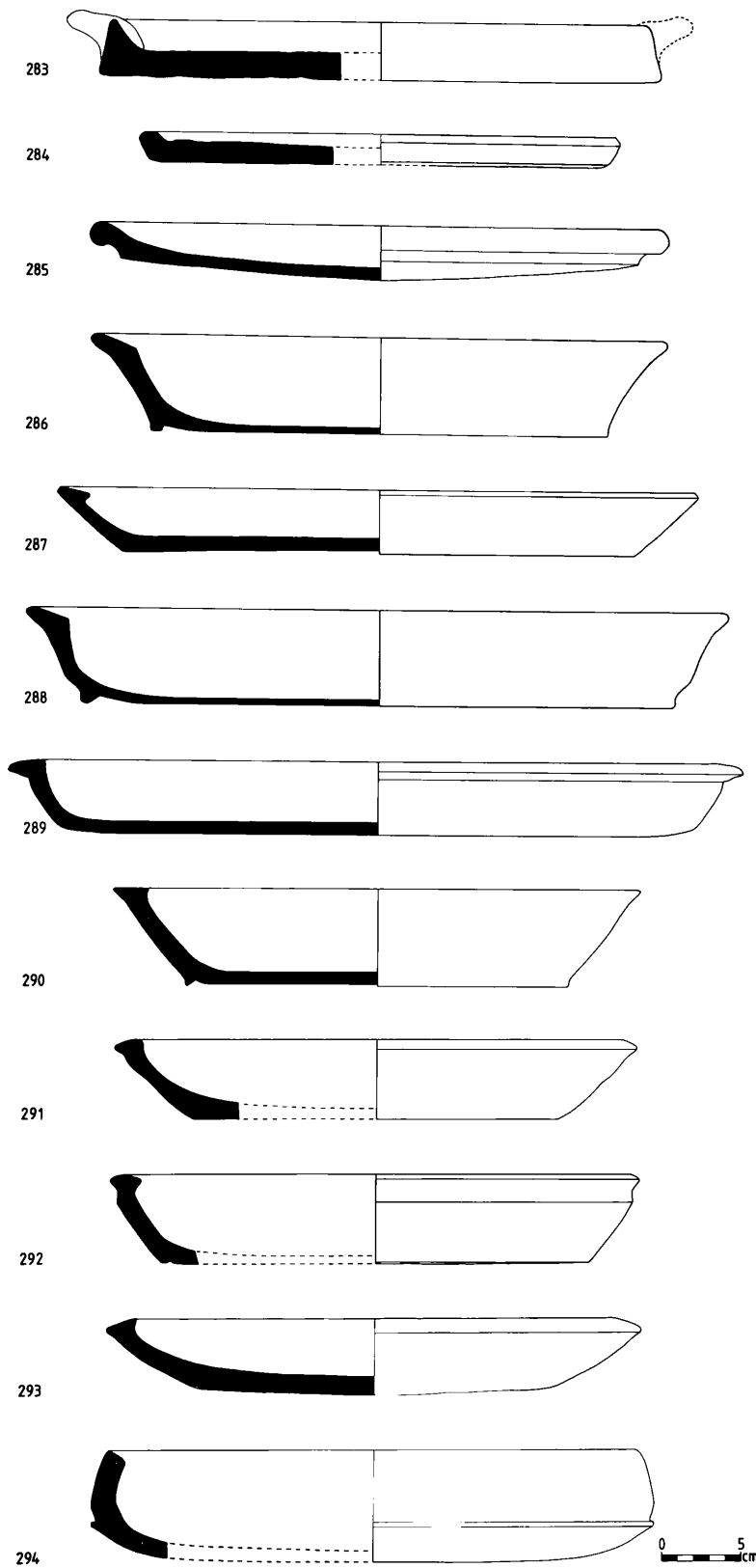

PLATE 47

ROUGH-BASED SHALLOW BOWLS – OLD BABYLONIAN

Pot No	TR No	Batch	Level	Dimensions	Range	Ware and Remarks
295		C 950	C 6a	R: 23.0 cm H: 4.9 cm	C 6a	Ware: coarse yellow. Temper: grit and chaff. Handmade. Base: rough. Profile.
296		C 414	C 6a	R: 27.3 cm H: 3.4 cm	C 3-6	Ware: coarse pink. Temper: grit and chaff. Handmade. Base: rough. Profile.
297		A 593	A 3	R: 27.0 cm H: 5.7 cm	A 3 C 5-7	Ware: coarse orange-buff. Temper: few grits and much chaff. Handmade. Base: rough. Profile.
298		C 78	C 6	R: 26.4 cm H: 4.5 cm	A 3 C 4-6	Ware: coarse orange-buff. Temper: large white grit and chaff. Handmade. Base: rough. Profile.
299		C 78	C 6	R: 27.5 cm H: 4.2 cm	C 1-6	Ware: coarse orange-buff. Temper: large white grit and chaff. Handmade. Base: rough. Profile.
300		C 52	C 6	R: 25.8 cm H: 3.5 cm	C 5-7	Ware: coarse orange-buff. Temper: grit and chaff. Handmade. Base: rough. Profile.
301		A 565	A 3	R: 26.3 cm H: 5.0 cm	C 6a-6	Ware: coarse orange-buff. Temper: grit and chaff. Handmade. Base: rough. Profile.
302		C 77	C 6a	R: 22.4 cm H: 5.0 cm	C 5-6	Ware: coarse orange-buff. Temper: little grit and chaff. Handmade. Base: rough. Profile.
303		C 78	C 6	R: 22.0 cm H: 4.5 cm	C 4-6	Ware: coarse pink-buff. Temper: grit and chaff. Handmade. Base: rough. Profile.
304		C 78	C 6	R: 21.8 cm H: 5.0 cm	C 6	Ware: coarse pink-buff. Temper: grit and chaff. Handmade. Base: rough. Profile.
305		C 52	C 6	R: 22.0 cm H: 4.4 cm		Ware: coarse orange-buff. Temper: grit and chaff. Handmade. Base: rough. Profile.
306		C 46	C 6	R: 20.0 cm H: 4.5 cm	C 6a-6	Ware: coarse orange-buff. Temper: grit and chaff. Handmade. Base: rough. Profile.
307		A 600	A 3	R: 28.0 cm H: 3.9 cm	A 3	Ware: coarse orange-buff. Temper: white grit and chaff. Handmade. Base: rough, then smoothed. Profile.
308		A 280	A 2	R: 20.0 cm H: 4.9 cm	A 3 C 5-6	Ware: very coarse buff. Temper: grit and chaff. Handmade. Base: rough. Profile.
309		C 78	C 6	R: 21.0 cm H: 5.5 cm	A 3 C 6a	Ware: coarse buff. Temper: grit and little chaff. Handmade. Base: rough. Profile.
310		A 726	A 3	R: 23.0 cm H: 5.8 cm	C 6	Ware: coarse light brown. Temper: grit and chaff. Handmade. Base: rough. Profile.
311	4130	C 78	C 6	R: 21.2 cm H: 4.5 cm B: 18.5 cm	A 2c	Ware: coarse cream. Temper: grit and chaff. Handmade. Base: rough. Surface: smoothed. Warped. Found upside-down over tablet TR 4971. Complete.
312		C 334	C 6	R: 23.8 cm H: 5.2 cm	C 6	Ware: coarse red. Temper: grit and chaff. Handmade. Base: rough. Profile.
313		C 86	C 5b	R: 16.0 cm H: 4.2 cm	C 6a-6	Ware: coarse light-brown. Temper: grit and chaff. Handmade. Base: rough. Profile.
314		C 406	C 6a	R: 16.6 cm H: 4.1 cm	A 1 C 6a-6	Ware: coarse pale green. Temper: grit and chaff. Handmade. Base: rough. Profile.
315		C 414	C 6a	R: 18.0 cm H: 3.9 cm	C 4-6	Ware: coarse green. Temper: grit and chaff. Handmade. Base: rough. Profile.
316		C 360	C 5a	R: 19.8 cm H: 3.6 cm	C 5-6	Ware: coarse pale green. Temper: white grit and chaff. Handmade. Base: rough. Overfired, warped and uneven. Profile.
317		A 735	A 3	R: 20.0 cm H: 5.0 cm	C 6	Ware: coarse pink to white. Temper: grit and chaff. Handmade. Base: rough. Profile.
318		C 392	C 6	R: 25.0 cm H: 6.3 cm	C 4-6	Ware: coarse pink to buff. Temper: grit and chaff. Handmade. Base: rough. Profile.

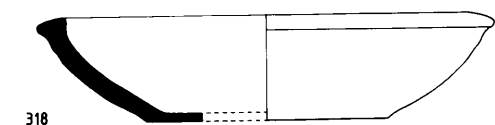
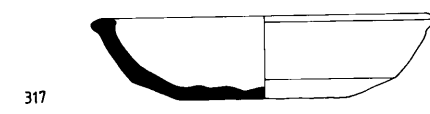
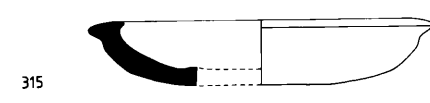
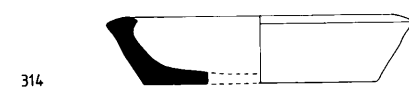
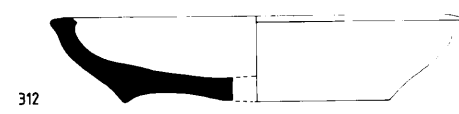
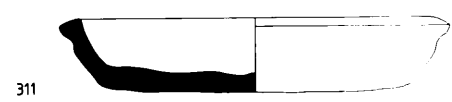
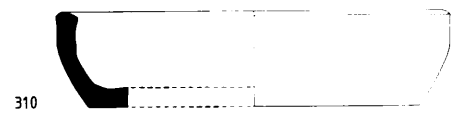
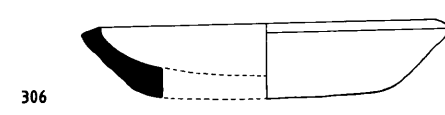
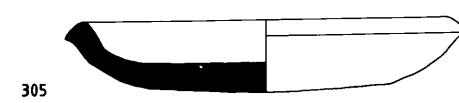
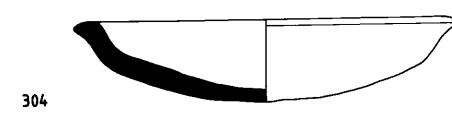
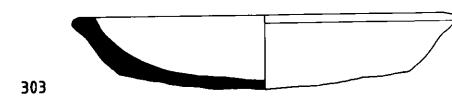
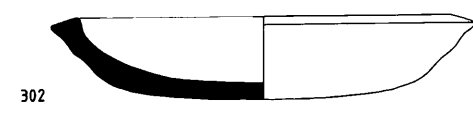
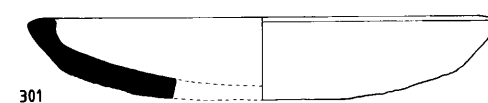
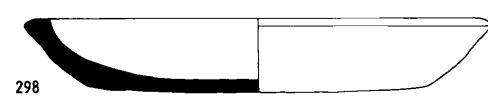
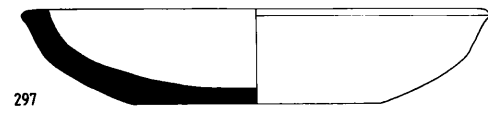
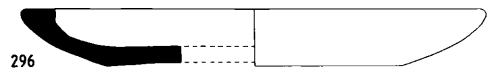
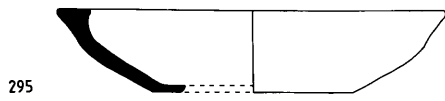

PLATE 48

ROUGH-BASED SHALLOW BOWLS – OLD BABYLONIAN

Pot No	TR No	Batch	Level	Dimensions	Range	Ware and Remarks
319		C 689	C 6a	R: 23.0 cm H: 5.1 cm		Ware: coarse pink-buff. Temper: grit and chaff. Handmade. Base: rough. Profile.
320		A 463	A 3 late	R: 19.5 cm H: 3.8 cm	C 4-5	Ware: coarse pink-buff. Temper: grit and chaff. Handmade. Base: rough. Profile.
321		A 408	A 3 late	R: 17.8 cm H: 3.4 cm	A 3 C 5-6	Ware: coarse buff. Temper: grit and chaff. Handmade. Base: rough. Profile.
322		A 484	A 3	R: 24.5 cm H: 4.8 cm	C 6a-6	Ware: coarse pink-red. Temper: grit and chaff. Handmade. Base: rough. Profile.
323		C 28	C 6a	R: 23.5 cm H: 4.5 cm	A 1-3 C 4-6	Ware: coarse orange-buff. Temper: grit and chaff. Handmade. Base: rough. Profile.
324		A 56	A 3	R: 20.0 cm H: 4.3 cm	A 2c-3 C 5-6	Ware: coarse buff. Temper: grit and chaff. Handmade. Base: rough. Profile.
325		A 329	A 2c	R: 18.0 cm H: 4.4 cm	C 2-5	Ware: coarse green. Temper: chaff. Handmade. Base: rough. Profile.
326		C 29	C 6a	R: 19.8 cm H: 4.5 cm	A 3 C 4-6	Ware: coarse buff. Temper: grit and chaff. Handmade. Base: rough. Profile.
327		C 368	C 6a	R: 25.5 cm H: 5.0 cm	C 56a-6	Ware: coarse buff. Temper: white grit and chaff. Handmade. Base: rough. Profile.
328		C 950	C 6a	R: 24.5 cm H: 4.6 cm	A 3 C 6a	Ware: coarse yellow. Temper: grit and chaff. Handmade. Base: rough. Profile.
329		C 369	C 6a	R: 23.5 cm H: 5.0 cm	A 3 C 5-6	Ware: coarse pink-buff. Temper: grit and chaff. Handmade. Base: rough. Profile.
330		C 372	C 5b	R: 25.5 cm H: 4.0 cm	A 3 C 5-6	Ware: coarse pink to white. Temper: grit and chaff. Handmade. Base: rough. Profile.
331		A 695	A 3	R: 20.0 cm H: 4.0 cm	A 3 C 5-6	Ware: coarse salmon-pink. Temper: grit and some chaff. Handmade. Base: rough. Profile.
332		C 411	C 6	R: 25.5 cm H: 4.6 cm	A 3 C 6a-6	Ware: coarse red-brown. Temper: grit and chaff. Handmade. Base: rough. Profile.
333		C 403	C 6a	R: 26.0 cm H: 5.8 cm	A 3 C 6a-6	Ware: coarse buff to white. Temper: grit and chaff. Handmade. Base: rough. Profile.
334		C 369	C6a	R: 23.0 cm H: 4.4 cm	A 3 C 5-6	Ware: coarse yellow-buff. Temper: grit and chaff. Handmade. Base: rough. Profile.
335		A 588	A 3	R: 22.5 cm H: 3.5 cm	A 3 C 5-6	Ware: coarse light buff. Temper: grit and chaff. Handmade. Base: rough. Profile.
336		A 584	A 3	R: 22.0 cm H: 5.0 cm	A 3 C 5-6	Ware: coarse yellow-buff. Temper: grit and chaff. Handmade. Base: rough. Profile.
337		C 29	C 6a	R: 19.8 cm H: 5.2 cm	C 5-6	Ware: coarse buff. Temper: grit and chaff. Handmade. Base: rough. Profile.
338		C 378	C 5b	R: 21.0 cm H: 5.1 cm	C 5-6	Ware: coarse yellow-buff. Temper: grit and chaff. Handmade. Base: rough. Profile.
339		C 369	C 6a	R: 19.0 cm H: 4.2 cm	C 5-6a	Ware: coarse buff to white. Temper: grit and chaff. Handmade. Base: rough. Profile.
340		A 633	A 3	R: 22.0 cm H: 4.3 cm	C 5	Ware: coarse buff to white. Temper: grit and chaff. Handmade. Base: rough. Profile.
341		C 361	C 5	R: 18.8 cm H: 4.8 cm	C 5-6	Ware: coarse buff. Temper: white grit and chaff. Handmade. Base: rough. Profile.
342		C 34	C 5b	R: 17.4 cm H: 4.4 cm	C 5-6	Ware: coarse orange-grey. Temper: grit and chaff. Handmade. Base: rough. Surface: smoothed. Profile.
343		A 317	A 2	R: 15.0 cm H: 4.5 cm	C 6	Ware: coarse pink-buff. Temper: grit and chaff. Handmade. Base: rough. Profile.
344		C 29	C 6a	R: 18.0 cm H: 5.3 cm	A 3 C 5-6	Ware: coarse orange-buff. Temper: grit and chaff. Handmade. Base: rough. Profile.
345		C 372	C 5b	R: 22.0 cm H: 4.0 cm	C 5-6a	Ware: coarse pink-buff. Temper: grit and chaff. Handmade. Base: rough. Profile.
346		C 383	C 5b	R: 20.0 cm H: 4.0 cm	C 5-6a	Ware: coarse buff. Temper: grit and chaff. Handmade. Base: rough. Profile.
347		C 411	C 6	R: 16.6 cm H: 4.1 cm	C 6a	Ware: coarse yellow. Temper: grit and chaff. Handmade. Base: rough. Profile.
348		C 392	C 6	R: 22.0 cm H: 6.0 cm	C 6a	Ware: coarse buff to white. Temper: grit and chaff. Handmade. Base: rough. Profile.

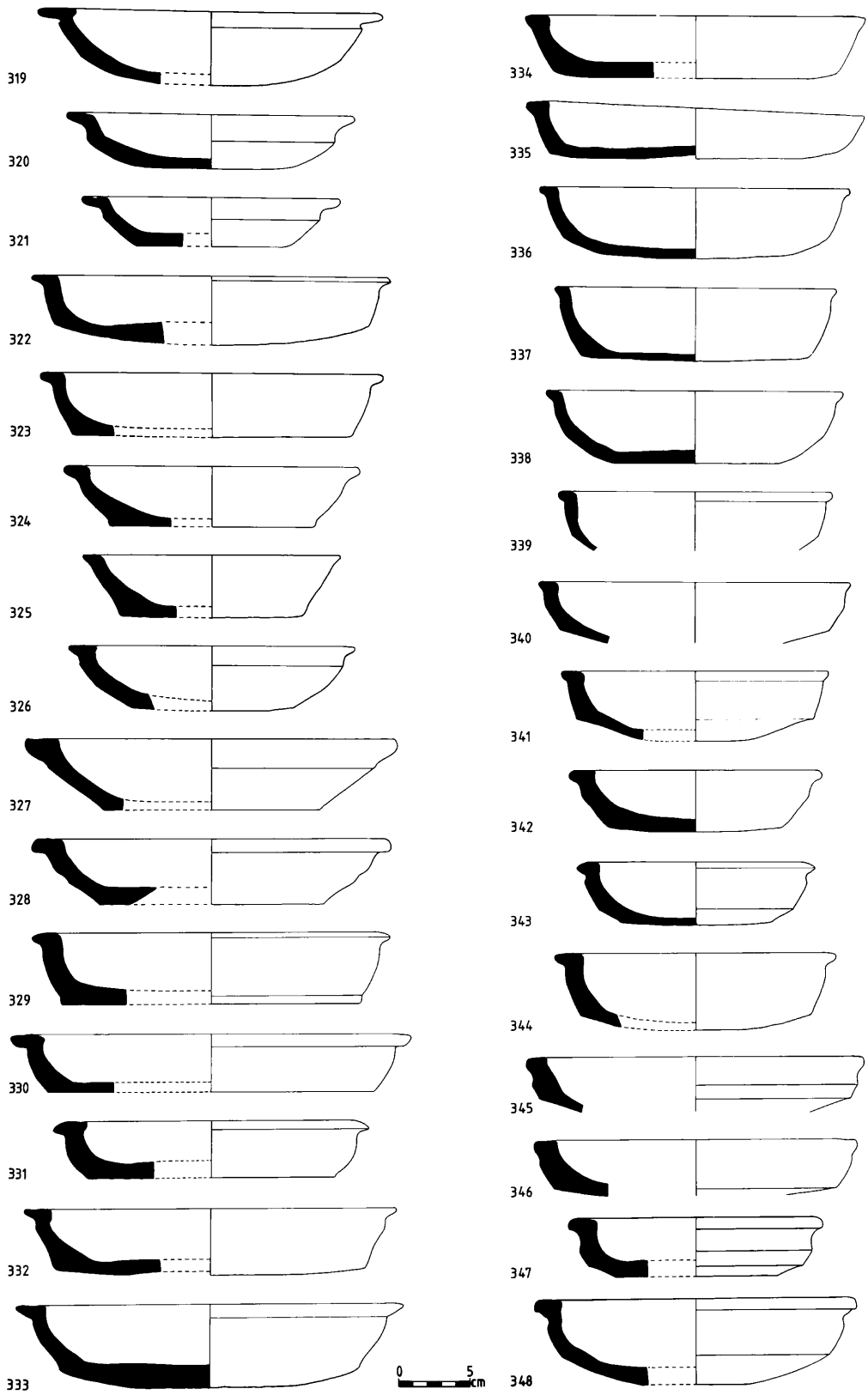

PLATE 49

ROUGH-BASED SHALLOW BOWLS – OLD BABYLONIAN

Pot No	TR No	Batch	Level	Dimensions	Range	Ware and Remarks
349		A 497	A 3	R: 19.8 cm H: 5.2 cm	A 2c-3 C 6a	Ware: coarse green. Temper: grit and chaff. Handmade. Base: rough. Finger-impressed ridges round outside. Profile.
350		A 252	Topsoil	R: 19.0 cm H: 5.2 cm		Ware: coarse green. Temper: chaff. Handmade. Base: rough. Finger-impressed ridges round outside. Profile.
351		A 599	A 3	R: 19.8 cm H: 5.1 cm	A 2c-3	Ware: medium coarse buff. Temper: grit and chaff. Handmade. Base: rough. Finer finish than usual. Profile.
352		C 29	C 6a	R: 19.5 cm H: 5.3 cm	C 5-6	Ware: coarse green. Temper: grit and chaff. Handmade. Base: rough. Profile.
353		C 948	C 6a	R: 21.0 cm H: 6.2 cm	C 5b	Ware: coarse red to green. Temper: grit and chaff. Handmade. Base: rough. Profile.
354		A 426	A 2c	R: 18.0 cm H: 5.1 cm	C 5	Ware: coarse red to white. Temper: grit and chaff. Handmade. Base: rough. Profile.
355		A 358	A 3	R: 21.5 cm H: 5.0 cm	A 3 C 6a	Ware: coarse green to white. Temper: chaff. Handmade. Base: rough. Profile.
356		C 77	C 6a	R: 19.5 cm H: 6.0 cm	C 5-6	Ware: coarse yellow-buff. Temper: chaff. Handmade. Base: rough. Profile.
357		C 378	C 5b	R: 19.0 cm H: 5.7 cm	C 4-6	Ware: coarse red-brown. Temper: grit and chaff. Handmade. Base: rough. Profile.
358		C 29	C 6a	R: 20.0 cm H: 5.0 cm	A 3 C 5-6	Ware: coarse orange to white. Temper: white grit. Handmade. Base: rough. Profile.
359		C 378	C 5b	R: 21.8 cm H: 4.1 cm		Ware: coarse yellow-buff. Temper: grit and chaff. Handmade. Base: rough. Profile.
360		C 947 C 948	C 6a	R: 24.0 cm H: 6.3 cm	A 3	Ware: coarse pink. Temper: grit and chaff. Handmade. Base: rough. Profile.
361		C 920	C 6	R: 31.6 cm H: 4.9 cm	C 6a-6	Ware: coarse buff. Temper: grit and chaff. Handmade. Base: rough. Profile.
362		A 454	A 3 late	R: 23.3 cm H: 4.4 cm		Ware: coarse pink-buff. Temper: grit and chaff. Handmade. Base: rough. Profile.
363		A 599	A 3	R: 25.2 cm H: 4.3 cm	A 2c-3 C 4-6	Ware: coarse brown. Temper: small grit and chaff. Handmade. Base: rough. Profile.
364		A 637	A 3	R: 22.4 cm H: 3.6 cm	A 3 C 5-6	Ware: coarse buff. Temper: grit and chaff. Handmade. Base: rough. Profile.
365		A 593	A 3	R: 29.0 cm H: 5.5 cm	C 6a	Ware: coarse pink with grey-buff core. Temper: grit and chaff. Handmade. Base: rough. Profile.
366		C 411	C 6	R: 26.0 cm H: 5.0 cm	A 3 C 6a-6	Ware: coarse pink to white. Temper: grit and chaff. Handmade. Base: rough. Profile.
367		A 709	A 3	R: 22.6 cm H: 4.2 cm	A 3 C 6	Ware: coarse buff. Temper: grit and chaff. Handmade. Base: rough. Profile.
368		A 723	A 3	R: 22.0 cm H: 4.2 cm	A 3 C 6a	Ware: coarse buff-brown. Temper: grit and chaff. Handmade. Base: rough. Profile.
369		C 414	C 6a	R: 24.0 cm H: 4.3 cm	C 4-6a	Ware: coarse buff. Temper: grit and chaff. Handmade. Base: rough. Profile.
370		A 565	A 3	R: 20.8 cm H: 5.0 cm	A 3 C 6a	Ware: coarse orange-buff. Temper: grit and chaff. Handmade. Base: rough. Profile.
371		A 670	A 3	R: 26.0 cm H: 4.2 cm	A 3 C 5	Ware: coarse green. Temper: grit and chaff. Handmade. Base: rough. Overfired. Profile.
372		A 737	A 3	R: 26.8 cm H: 4.1 cm	C 6a-6	Ware: coarse buff. Temper: grit and chaff. Handmade. Base: rough. Profile.

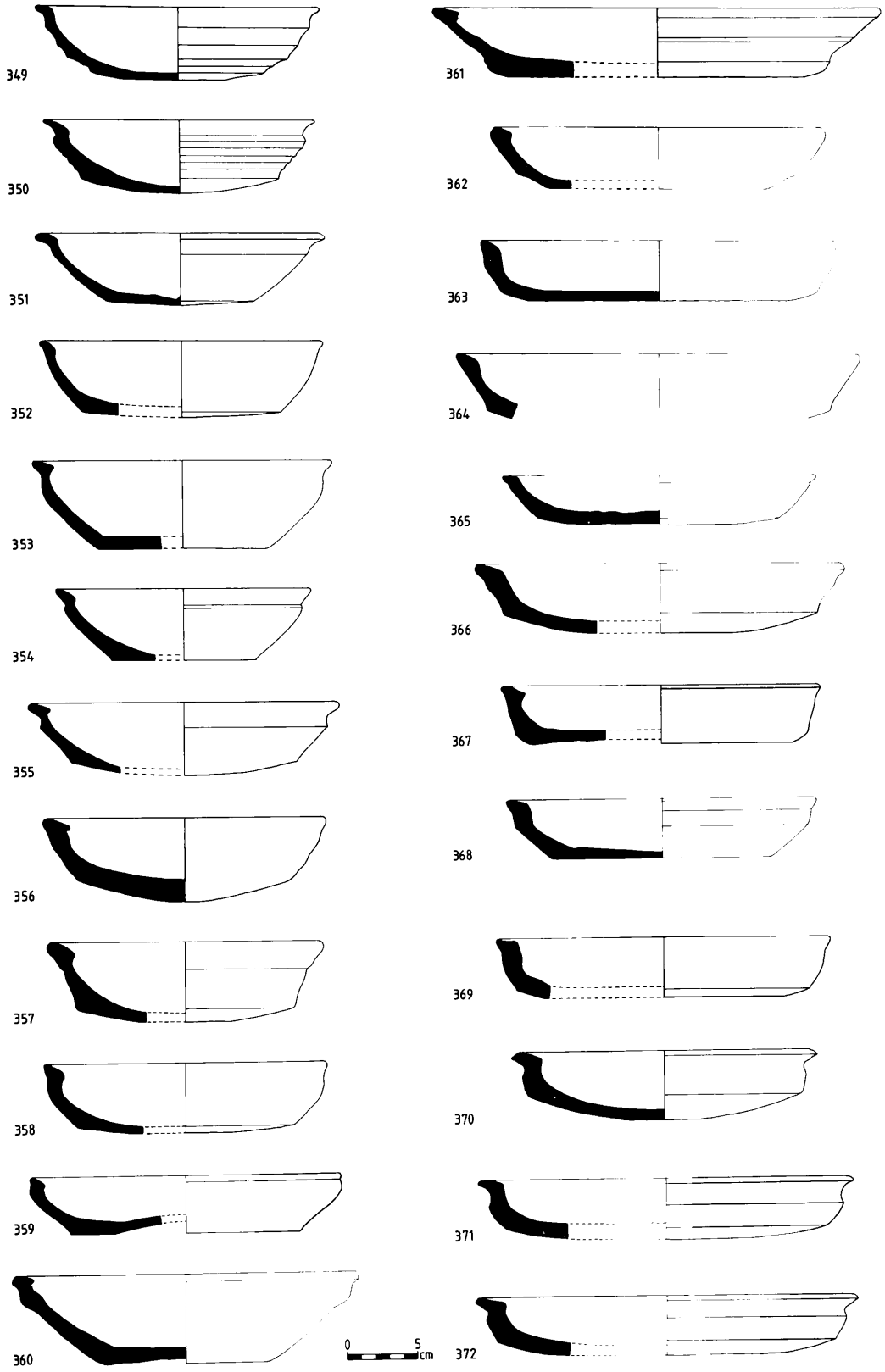

PLATE 50

SHALLOW BOWLS – OLD BABYLONIAN

Pot No	TR No	Batch	Level	Dimensions	Range	Ware and Remarks
373		C 28	C 6a	R: 19.5 cm H: 5.2 cm	A 2c-3 C 4-7	Ware: coarse buff. Temper: grit and chaff. Handmade. Base: rough. Profile.
374		A 571	A 3	R: 21.5 cm H: 5.0 cm	A 2c-3 C 5-6	Ware: coarse pink-buff. Temper: grit and chaff. Handmade. Base: rough. Profile.
375		A 395	A 3 late	R: 18.5 cm H: 4.3 cm	A 3 C 5-6	Ware: coarse buff to red with black core. Temper: grit and chaff. Handmade. Base: rough. Profile.
376		C 676	C 5b	R: 23.5 cm H: 5.3 cm	A 2c-3 C 6	Ware: coarse pink-buff. Temper: some grit and chaff. Handmade. Base: rough. Profile.
377		C 421	C 6	R: 25.2 cm H: 6.3 cm	C 4-6	Ware: coarse buff. Temper: grit and chaff. Handmade. Base: rough. Traces of red ochre inside and on rim. Profile.
378		A 601	A 3	R: 23.0 cm H: 6.0 cm	A 3 C 5-6	Ware: coarse orange-buff. Temper: chaff. Handmade. Base: rough. Profile.
379		A 599	A 3	R: 20.0 cm H: 5.4 cm	A 3	Ware: coarse red. Temper: grit and chaff. Handmade. Base: rough. Profile.
380		C 378	C 6a	R: 22.5 cm H: 4.4 cm	A 2c C 4-6	Ware: coarse grey-brown. Temper: grit and chaff. Handmade. Base: rough. Profile.
381		C 401	C 5	R: 22.0 cm H: 4.5 cm	C 4-6a	Ware: coarse buff. Temper: chaff. Handmade. Surface: smoothed. Base: rough. Profile.
382		C 378	C 5b	R: 23.0 cm H: 3.9 cm	C 6a-6	Ware: coarse orange-red. Temper: grit and chaff. Handmade. Base: rough. Profile.
383		A 252	Topsoil	R: 29.8 cm H: 5.5 cm	C 4-6	Ware: coarse buff to red. Temper: grit and chaff. Handmade. Base: rough. Profile.
384		A 599	A 3	R: 23.0 cm H: 4.0 cm	A 3 C 3-6	Ware: coarse pink-buff. Temper: grit and chaff. Handmade. Base: rough. Profile.
385		A 599	A 3	R: 22.5 cm H: 4.2 cm	A 3 C 5-6	Ware: coarse pink-buff. Temper: grit and chaff. Handmade. Base: rough. Profile.
386		C 382	C 5b	R: 22.6 cm H: 5.3 cm	A 2c-3 C 5-6	Ware: coarse red to white. Temper: grit and chaff. Handmade. Base: rough. Profile.
387		C 379	C 5	R: 25.8 cm H: 4.6 cm	C 5-6	Ware: coarse pink to white. Temper: grit and chaff. Handmade. Base: rough. Profile.
388		A 427	A 2c	R: 23.5 cm H: 3.0 cm	A 2a C 6a	Ware: medium coarse buff. Temper: grit and chaff. Handmade. Base: rough. Profile.
389		A 720	A 3 late	R: 22.5 cm H: 4.4 cm	C 5-6a	Ware: coarse cream. Temper: grit and chaff. Handmade. Base: rough. Profile.
390		A 720	A 3 late	R: 19.8 cm H: 4.1 cm	A 2c C 4-6	Ware: coarse salmon-pink to white. Temper: grit and chaff. Hand-made. Base: rough. Profile.
391		C 382	C 5b	R: 19.0 cm H: 4.9 cm	A 3 C 5-6a	Ware: coarse dark red-brown. Temper: grit and chaff. Handmade. Base: rough. Profile.
392		C 30	C 6a	R: 19.8 cm H: 5.3 cm	A 3 C 5-6a	Ware: coarse buff. Temper: grit and chaff. Handmade. Base: rough. Profile.

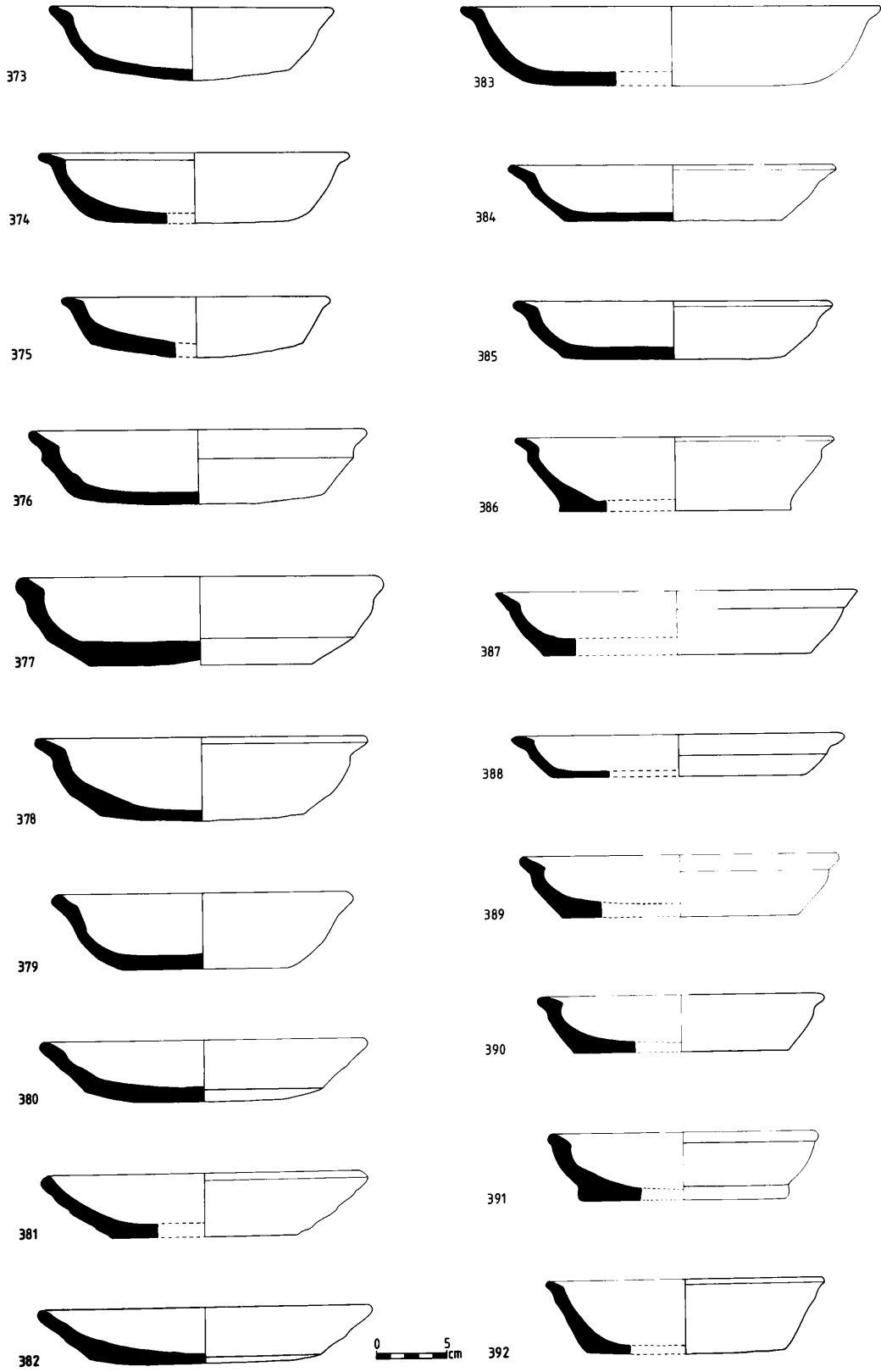

PLATE 51

BOWLS – OLD BABYLONIAN

Pot No	TR No	Batch	Level	Dimensions	Range	Ware and Remarks
393		A 482 A 483	A 3 late	R: 21.4 cm H: 8.4 cm	A 3	Ware: coarse pink-red. Temper: grit and chaff. Handmade. Base: rough. Surface: smoothed. Profile.
394		A 478	A 1	R: 23.2 cm H: 7.2 cm	A 3	Ware: coarse pink. Temper: grit and chaff. Handmade. Base: rough. Profile.
395		A 599	A 3	R: 22.0 cm H: 5.9 cm	C 6a	Ware: coarse orange-buff. Temper: chaff. Handmade. Base: rough. Profile.
396	3136	A 492 A 493	A 3	R: 20.2 cm H: 7.0 cm	A 3	Ware: coarse light buff. Temper: grit. Handmade. Base: rough, with an irregular hole D: 0.4 cm filled with bitumen. Warped. Complete.
397		A 569	A 3	R: 21.4 cm H: 6.1 cm	A 3 C 4-6	Ware: coarse buff. Temper: grit and chaff. Handmade. Base: rough. Profile.
398		A 568	A 3	R: 20.5 cm H: 6.3 cm	A 3	Ware: coarse buff to orange. Temper: grit and chaff. Handmade. Base: rough. Profile.
399	4119	A 590	A 3 late	R: 19.0 cm H: 5.7 cm	C 5	Ware: coarse buff. Temper: grit and chaff. Handmade. Base: rough. Complete.
400		A 585	A 3	R: 17.0 cm H: 5.5 cm		Ware: coarse pink to white. Temper: grit and chaff. Handmade. Base: rough. Profile.
401		A 587	A 3	R: 15.5 cm H: 5.4 cm	A 3 C 4	Ware: coarse orange-buff. Temper: grit and chaff. Handmade. Base: rough. Profile.
402		A 599	A 3	R: 22.0 cm H: 5.7 cm	A 3 C 5-6	Ware: coarse pink-buff. Temper: grit and much chaff. Handmade. Base: rough. Profile.
403		C 46	C 6	R: 23.0 cm H: 6.0 cm		Ware: coarse orange-buff. Temper: grit and chaff. Handmade. Base: rough. Profile.
404		A 584	A 3	R: 21.5 cm H: 6.0 cm	A 3 C 6	Ware: coarse yellow-buff. Temper: grit and chaff. Handmade. Base: rough. Profile.
405		A 570	A 2c	R: 21.6 cm H: 5.8 cm	A 2c-3	Ware: coarse buff. Temper: grit and chaff. Handmade. Base: rough. Profile.
406		A 574	A 3	R: 21.0 cm H: 6.7 cm		Ware: coarse orange-buff. Temper: grit and chaff. Handmade. Base: rough. Profile.
407		A 569	A 3	R: 20.5 cm H: 8.0 cm	A 3 C 6a	Ware: coarse pink-buff. Temper: grit and chaff. Handmade. Base: rough. Profile.
408		A 599	A 3	R: 17.8 cm H: 5.1 cm	A 2-3	Ware: medium coarse brown to orange. Temper: grit and chaff. Handmade. Base: rough. Profile.
409		A 599	A 3	R: 18.5 cm H: 5.8 cm		Ware: coarse red. Temper: grit and chaff. Handmade. Base: rough. Surface: smoothed. Profile.
410		A 599	A 3	R: 14.2 cm H: 8.0 cm		Ware: coarse brown. Temper: large grit and much chaff. Handmade. Base: rough. Surface: smoothed inside. Profile.

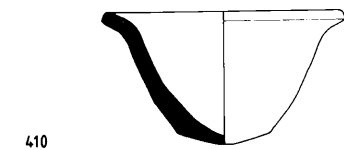
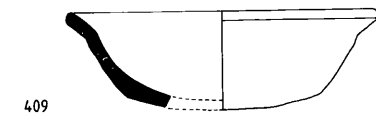
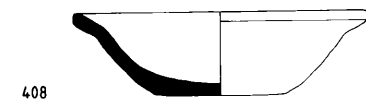
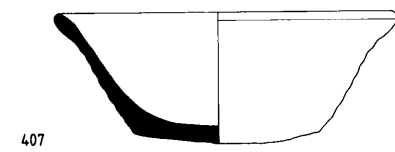
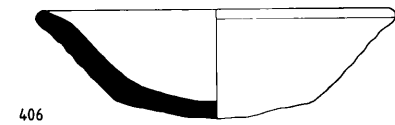
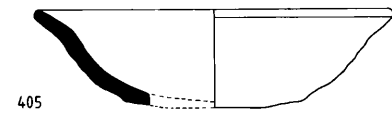
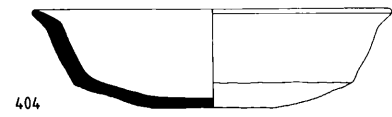
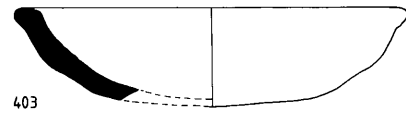
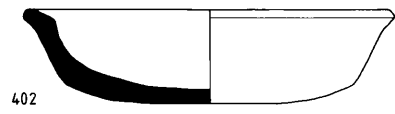
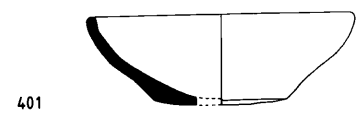
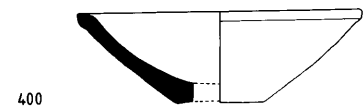
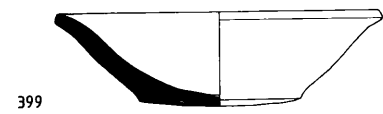
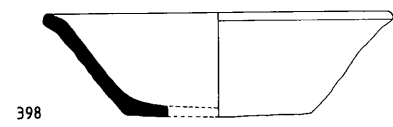
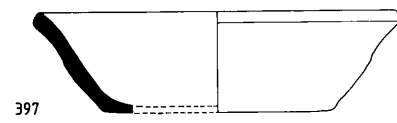
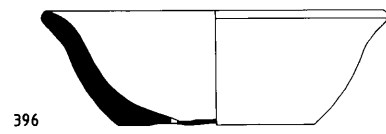
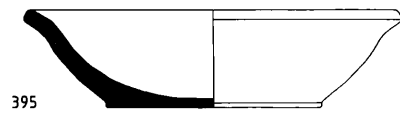
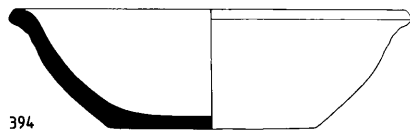
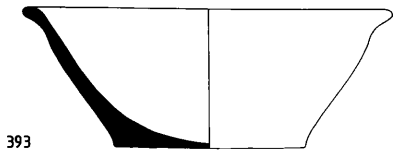

PLATE 52

SMALL BOWLS, LIDS AND LAMPS – OLD BABYLONIAN

Pot No	TR No	Batch	Level	Dimensions	Range	Ware and Remarks
411		C 951	C 6	R: 9.8 cm H: 3.4 cm B: 3.4 cm	C 6a-6	Ware: medium fine green-buff. Temper: grit and chaff. Base: string-cut. Burning on rim. Profile.
412	6018	C 686	C 6a	R: 11.6 cm H: 4.6 cm B: 3.8 cm	A 3 C 5-6	Ware: medium fine red. Temper: large white grit and chaff. Base: string-cut then turned. Burning on rim. Found in Pot 1025. Pot AD <i>Figure 11</i> . Complete.
413		C 586	C 5	R: 14.0 cm H: 6.0 cm B: 5.0 cm	C 5-6	Ware: medium fine dark red. Temper: grit and little chaff. Base: string-cut. Well made. Profile.
414		A 584	A 3	R: 11.0 cm H: 4.6 cm B: 3.8 cm	A 1-3 C 6a-6	Ware: medium fine pink to brown. Temper: grit and chaff. Base: string-cut. Profile.
415		C 385	C 5a	R: 13.0 cm H: 5.4 cm B: 3.6 cm	C 5-6a	Ware: medium fine pink to cream. Temper: grit and chaff. Base: string-cut. Profile.
416		C 42	C 6	R: 14.5 cm H: 5.2 cm B: 5.3 cm	A 1-3	Ware: medium fine yellow-buff. Temper: few grits and chaff. Base: string-cut. Profile.
417		C	C 5	R: 12.8 cm H: 4.6 cm B: 4.2 cm		Ware: fine buff. Temper: grit and chaff. Base: string-cut. Warped, oval shape. Profile.
418	3137	A 492 A 493	A 3	R: 15.2 cm H: 5.0 cm B: 5.8 cm	C 5	Ware: medium fine red-buff. Temper: grit and chaff. Base: string-cut. Surface: burnished inside, smoothed outside. Complete.
419	4118	A 590	A 3 late	R: 13.1 cm H: 5.7 cm B: 6.0 cm	A 3 C 2-6	Ware: medium fine buff. Temper: grit and chaff. Base: string-cut. Complete.
420	5050	C 395	C 6	R: 11.2 cm H: 2.6 cm	C 5	Ware: fine buff. Temper: white grit. Base: string-cut. Well finished. Complete.
421		A 552	A 3	R: 11.2 cm H: 2.5 cm	C 4	Ware: medium fine pink-buff. Temper: grit and chaff. Base: string-cut. Surface: smoothed. Profile.
422		C 553	C 6	R: 11.8 cm H: 3.0 cm	C 6	Ware: medium fine buff. Temper: grit and chaff. Base: string-cut. Very uneven. Profile.
423		A 599	A 3	R: 9.4 cm H: 3.0 cm		Ware: medium fine orange-buff. Temper: grit and chaff. Base: string-cut. Profile.
424		C 968	C 6	R: 11.6 cm H: 4.1 cm	C 6a-6	Ware: medium fine red. Temper: grit and chaff. Base: string-cut then smoothed. Hole in base: D: 0.9 cm. Profile.
425		C 395	C 6	R: 11.6 cm H: 3.4 cm	C 6	Ware: medium fine buff. Temper: grit and chaff. Base: string-cut, rough. Hole in base: D: 0.8 cm. Profile.
426		C 808	C 6	R: 10.0 cm H: 2.5 cm	C 6a-6	Ware: fine buff. Temper: grit and chaff. Base: string-cut. Hole in base: D: 0.6 cm. Profile.
427		C 813	C 7	R: 10.0 cm H: 2.5 cm		Ware: medium fine red. Temper: grit and chaff. Base: string-cut, rough. Hole in base: D: 0.5 cm. Profile.
428	5045	C 395	C 6	R: 11.0 cm H: 2.8 cm	C 6	Ware: medium fine buff. Temper: grit and chaff. Base: string-cut. Knob in centre of base has a spiral groove around it. Possibly a lid. Complete.
429	6046	C 801	C 6	R: 10.5 cm H: 2.5 cm	A 3 C 6a-6	Ware: medium fine green. Temper: grit and chaff. Base: string-cut. Hollow knob in centre of base. Possibly a lid. Almost complete. Plate 24d
430		C 445	C 6	R: 11.5 cm H: 2.1 cm	C 5-6	Ware: medium fine pale green. Temper: fine grit and chaff. Base: string-cut. Hollow knob in centre of base. Possibly a lid. Profile.

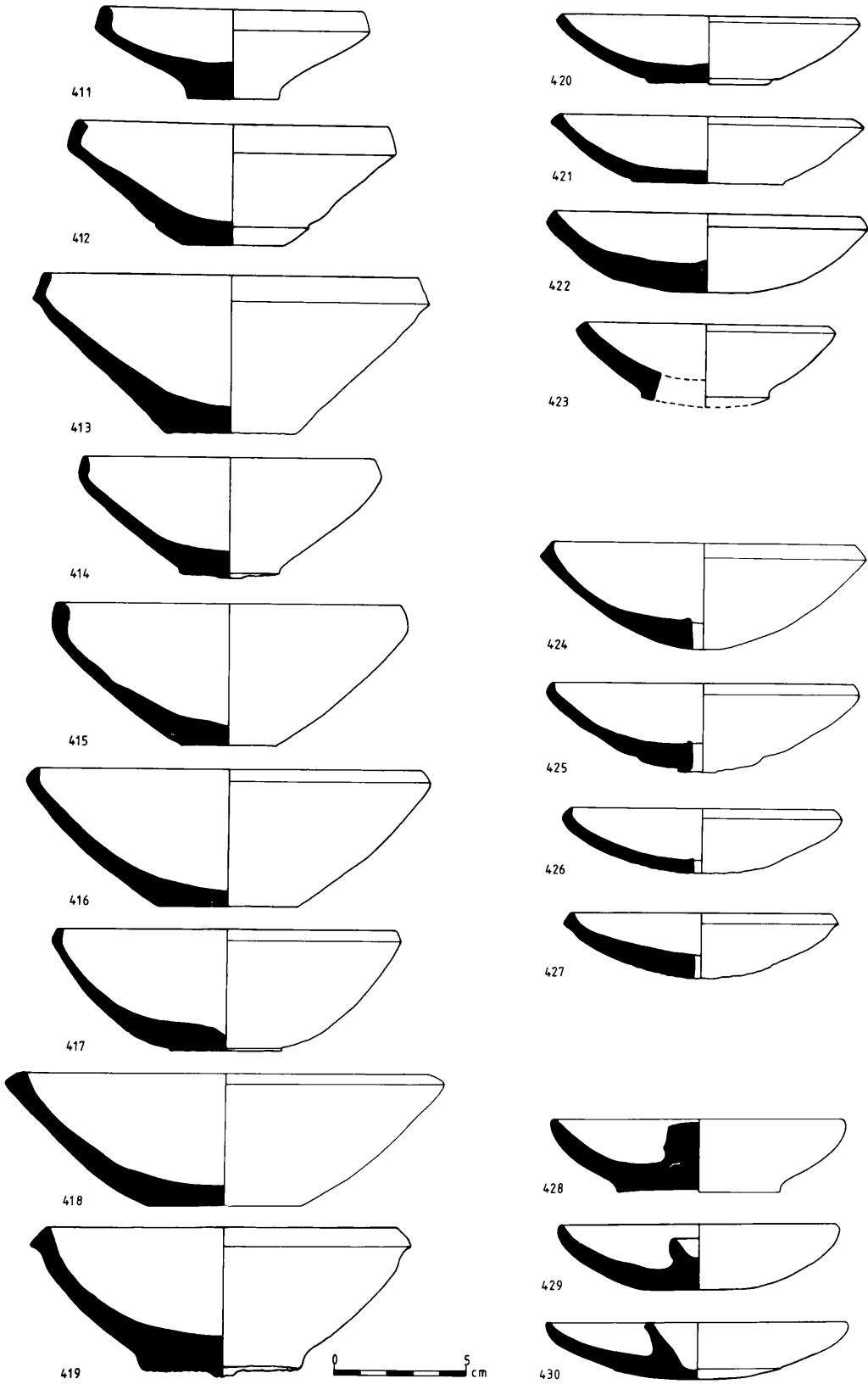

PLATE 53

SMALL BOWLS – OLD BABYLONIAN

Pot No	TR No	Batch	Level	Dimensions	Range	Ware and Remarks
431			Surface	R: 11.5 cm H: 3.8 cm	C 2	Ware: medium fine buff. Temper: grit and chaff. Base: string-cut, rough. Profile.
432		C 685	C 5b	R: 9.0 cm H: 3.4 cm		Ware: medium fine buff. Temper: some large white grit and chaff. Base: string-cut, rough. Profile.
433		C 925	C 6a	R: 8.3 cm H: 4.5 cm	C 6a	Ware: medium coarse red. Temper: grit and much chaff. Base: broken. Profile.
434		C 378	C 5b	R: 12.0 cm H: 5.5 cm	C 6a-6	Ware: medium fine red to cream. Temper: grit and chaff. Base: string-cut. Patches of bitumen on rim. Profile.
435	6021	C 686	C 6a	R: 11.0 cm H: 4.8 cm		Ware: medium fine green. Temper: grit and chaff. Base: string-cut. Burning on rim. Pot O <i>Figure 11</i> . Complete.
436		C 686	C 6a	R: 10.0 cm H: 4.3 cm		Ware: medium fine green. Temper: some large white grit and chaff. Base: string-cut. Profile
437		C 954	C 6a	R: 10.0 cm H: 4.1 cm	A 3 C 6a	Ware: fine buff. Temper: fine grit. Base: string-cut. Profile.
438	6022	C 686	C 6a	R: 9.2 cm H: 4.0 cm	A 2c-3 C 6a-6	Ware: fine buff. Temper: grit. Base: string-cut. Found in Pot 1025. Pot AE <i>Figure 11</i> . Complete.
439		A 265	A 2c-3	R: 9.4 cm H: 3.5 cm	C 6	Ware: fine orange. Temper: grit. Base: string-cut. Surface: smoothed. Profile.
440		C 378	C 5b	R: 10.0 cm H: 3.4 cm	C 5-6a	Ware: fine buff. Temper: grit. Base: string-cut. Profile.
441		C 378	C 5b	R: 8.8 cm H: 3.2 cm	A 3	Ware: fine salmon-pink. Temper: fine grit. Base: string-cut. Profile.
442		C 948	C 6a	R: 10.6 cm H: 3.6 cm	A 3 C 4-6a	Ware: fine buff. Temper: some large white grit and chaff. Base: string-cut. Burning on rim. Profile.
443		A 413	A 3	R: 10.0 cm H: 3.5 cm	A 3 C 6a-6	Ware: fine buff. Temper: grit and chaff. Base: string-cut, then smoothed. Profile.
444		A 324	A 2c-3	R: 9.6 cm H: 3.3 cm	C 6a-6	Ware: medium fine orange. Temper: grit and chaff. Base: string-cut. Profile.
445		A 413	A 3	R: 9.4 cm H: 3.2 cm	A 3 C 6a-6	Ware: fine brick-red. Temper: grit. Base: string-cut. Profile.
446		C 905	C 5	R: 11.2 cm H: 3.7 cm	C 4-6a	Ware: fine red. Temper: grit and some chaff. Base: not string-cut. Profile.
447		A 492	A 3	R: 11.0 cm H: 2.9 cm	C 6	Ware: medium fine buff. Temper: grit and chaff. Base: string-cut. Warped. Profile.
448		A 452	A 3 late	R: 9.5 cm H: 2.8 cm	C 5	Ware: medium fine buff. Temper: much chaff. Base: string-cut. Warped. Profile.
449		A 408	A 3 late	R: 9.0 cm H: 2.3 cm	A 2c	Ware: medium fine buff. Temper: grit. Base: string-cut. Profile.
450		A 705	A 3	R: 9.3 cm H: 2.3 cm	A 1-3 C 6a-6	Ware: medium fine buff. Temper: white grit and chaff. Base: string-cut. Profile.
451		A 705	A 3	R: 9.5 cm H: 2.8 cm	C 5	Ware: medium fine salmon-pink to white. Temper: grit. Base: string-cut. Profile.
452		C 686	C 6a	R: 10.2 cm H: 3.3 cm	A 3	Ware: medium fine brown. Temper: grit and chaff. Base: string-cut. Surface: smoothed. Profile.
453		A 599	A 3	R: 8.1 cm H: 3.5 cm		Ware: medium fine buff to orange. Temper: large white grit. Base: string-cut. Profile.
454		C	C 5	R: 13.0 cm H: 4.5 cm		Ware: fine buff. Temper: grit and chaff. Base: string-cut. Warped. Profile.
455		C 679	C 6a	R: 10.0 cm H: 3.8 cm		Ware: medium coarse yellow-buff. Temper: grit and chaff. Base: string-cut. Burning on rim. Profile.
456		A 498	A 3	R: 9.5 cm H: 3.8 cm	C 6	Ware: fine pink to white. Temper: little chaff. Base: string-cut. Profile.

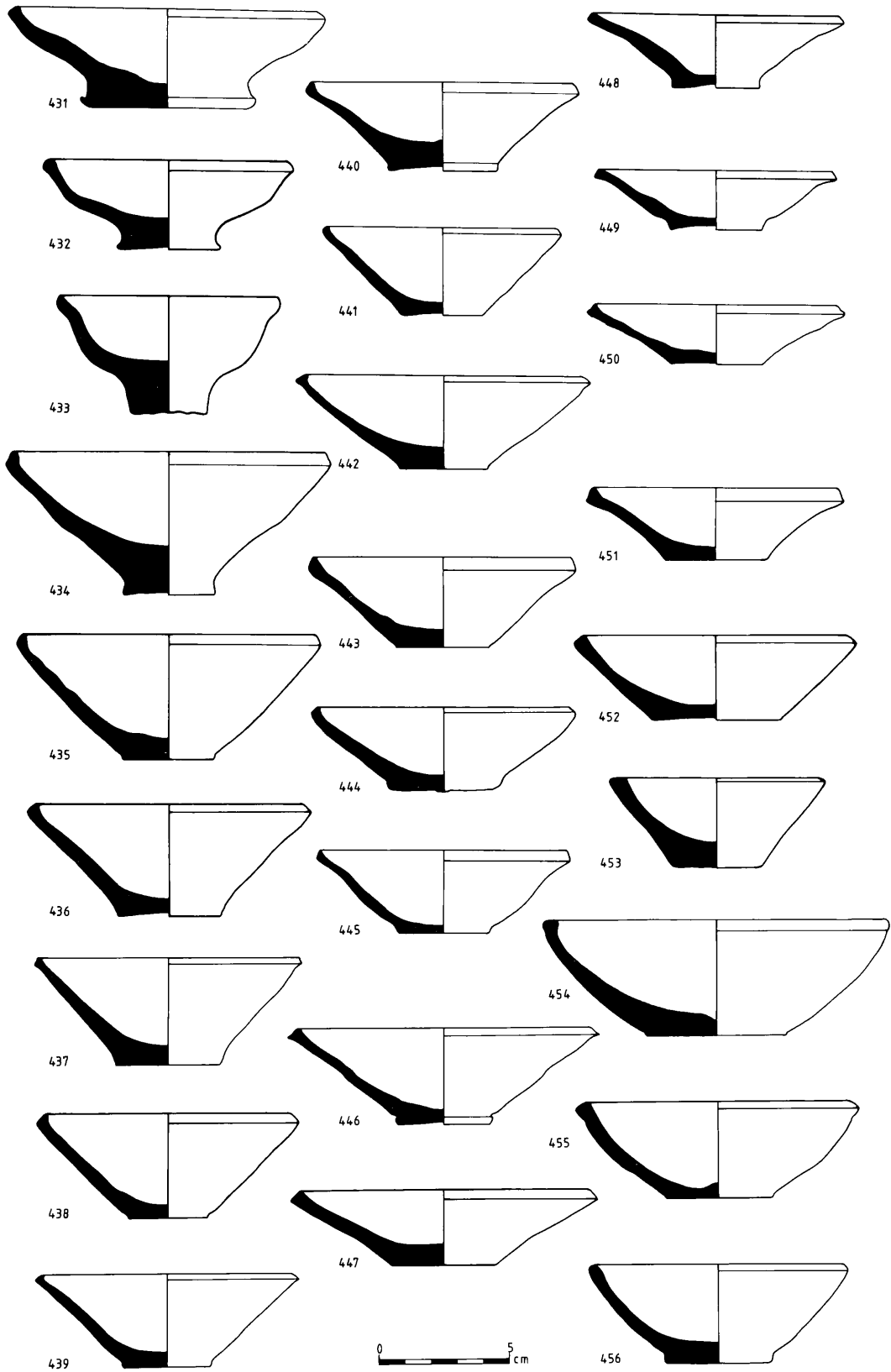

PLATE 54

SMALL BOWLS – OLD BABYLONIAN

Pot No	TR No	Batch	Level	Dimensions	Range	Ware and Remarks
457		C 445	C 6	R: 17.0 cm H: 3.8 cm B: 6.5 cm	C 5-6	Ware: fine buff to cream. Temper: grit. Warped. Profile.
458		C 52	C 6	R: 15.4 cm H: 4.0 cm B: 6.0 cm	C 5b-6	Ware: fine yellow-buff. Temper: few grits. Profile.
459		C 395	C 6	R: 14.5 cm H: 3.8 cm B: 6.4 cm	A 3 C 5b-6	Ware: fine green-buff. Temper: grit. Profile.
460		C 808	C 6	R: 13.8 cm H: 4.4 cm B: 7.0 cm	C 5b-6	Ware: medium fine buff. Temper: some large white grit and chaff. Warped. Burning at one point on rim. Profile.
461		C 445	C 6	R: 13.6 cm H: 4.1 cm B: 6.5 cm	C 5b-6	Ware: fine red-brown. Temper: grit. Surface: smoothed. Reconstructed profile.
462		A 585	A 3	R: 13.8 cm H: 4.1 cm B: 6.8 cm	A 3 C 3-6	Ware: fine pink-buff. Temper: small grit. Profile.
463		C 87	C 6	R: 13.0 cm H: 4.1 cm B: 6.5 cm		Ware: fine brown. Temper: white grit. Profile.
464		A 585	A 3	R: 16.4 cm H: 4.7 cm B: 8.8 cm	C 4-6	Ware: medium fine buff to white. Temper: grit and much chaff. Surface: lightly burnished. Profile.
465		A 480 A 482	A 3 late	R: 13.8 cm H: 4.4 cm B: 6.3 cm	A 3 C 5-6	Ware: medium fine buff. Temper: some white grit and much chaff. Profile.
466		C 78	C 6	R: 10.0 cm H: 3.6 cm	A 3 C 5b	Ware: very fine pink-buff. Temper: grit. Base: missing. Rim sherd.
467		C 696	C 6a	R: 11.6 cm H: 3.6 cm B: 4.4 cm	A 1-3 C 5-6	Ware: medium fine green. Temper: grit and chaff. Base: string-cut. Uneven. Burning at one point on rim. Profile.
468	6019	C 686	C 6a	R: 11.5 cm H: 3.4 cm B: 3.8 cm	C 5-6	Ware: fine buff. Temper: large white grit and some chaff. Surface: lightly burnished inside and out. Burning at one point on rim. Pot S <i>Figure 11</i> . Complete.
469		C 679	C 6a	R: 11.8 cm H: 3.9 cm B: 5.0 cm	C 6a	Ware: medium coarse yellow. Temper: grit and chaff. Burning on rim. Pot C <i>Figure 11</i> . Almost complete.
470		C	C 5	R: 11.5 cm H: 4.1 cm B: 4.4 cm	A 2a-3 C 5-6	Ware: fine buff to orange. Temper: grit. Base: string-cut, then smoothed. Profile.
471		A 565	A 3	R: 13.0 cm H: 4.1 cm B: 5.1 cm	A 3 C 6	Ware: fine buff to white. Temper: grit and chaff. Profile.
472		A 45	A 3 late	R: 14.4 cm H: 5.2 cm B: 5.0 cm	A 3	Ware: fine red. Temper: grit and some chaff. Well made. Profile.
473		A 652	A 3	R: 14.0 cm H: 4.7 cm B: 5.4 cm	C 1-5b	Ware: fine light green. Temper: grit and chaff. Surface: smoothed. Profile.
474		A 565	A 3	R: 13.0 cm H: 5.0 cm B: 7.0 cm	A 3-4 C 5-6	Ware: fine pink to white. Temper: grit and chaff. Profile.
475		A 565	A 3	R: 18.1 cm H: 5.3 cm B: 10.2 cm	A 3	Ware: fine buff to white. Temper: grit. Surface: well smoothed. Profile.

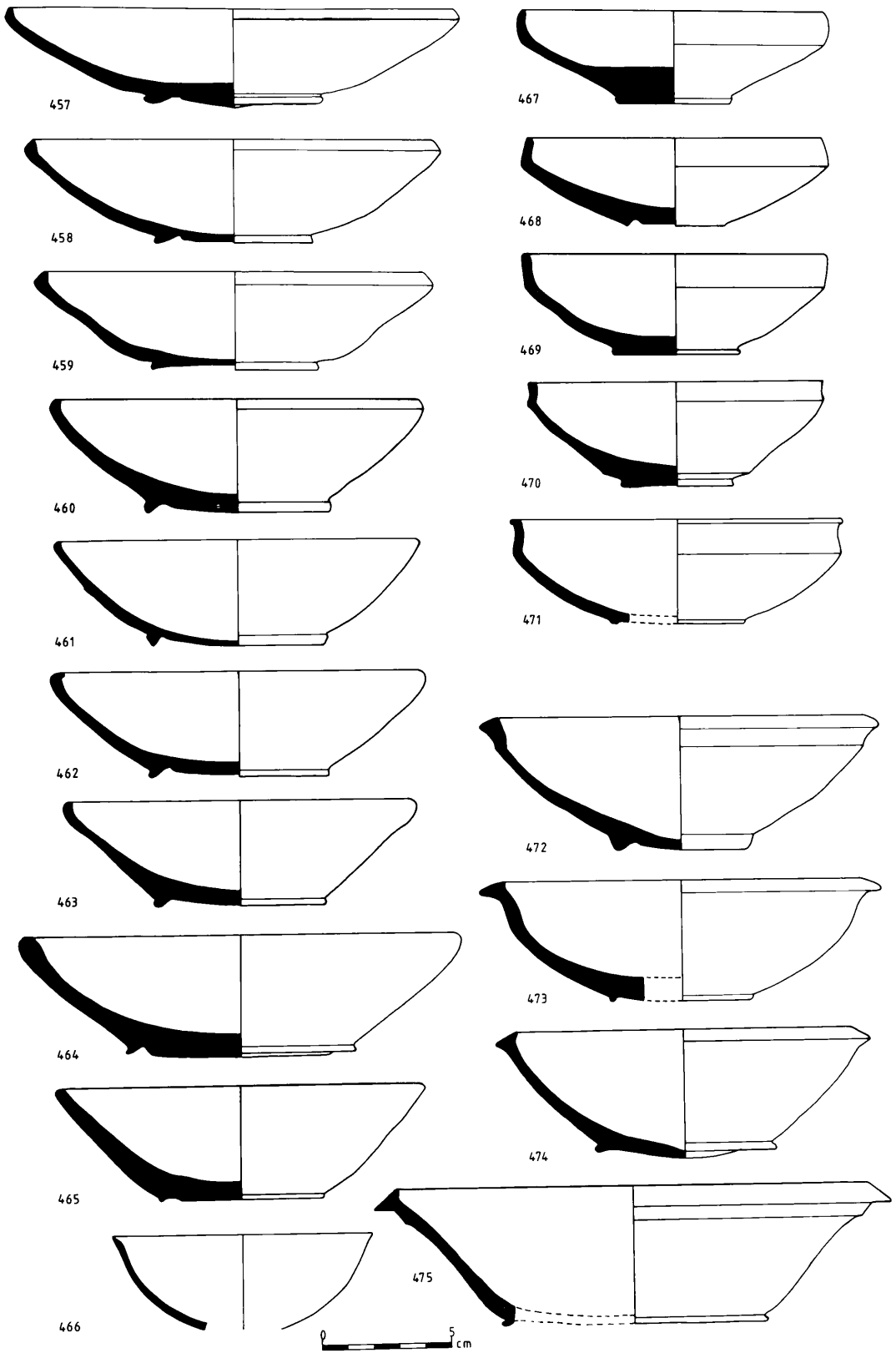

PLATE 55

BOWLS – LATE AND MIDDLE ASSYRIAN

Pot No	TR No	Batch	Level	Dimensions	Range	Ware and Remarks
476		C 156 CG 2-68	C 1	R: 6.4 cm H: 1.9 cm		Ware: fine pink. Temper: grit. Base: rounded. Profile.
477		A 592	A LA	R: 9.2 cm H: 2.0 cm B: 3.5 cm		Ware: fine buff. Temper: grit and chaff. Base: string-cut. Surface: smoothed. Profile.
478		A 401	A 1	R: 9.2 cm H: 2.5 cm B: 3.6 cm		Ware: fine buff. Temper: grit and chaff. Base: string-cut. Profile.
479		C 173	C 1	R: 9.0 cm H: 2.6 cm B: 4.4 cm		Ware: medium fine salmon-pink. Temper: grit and chaff. Surface: bitumen coating inside and out. Profile.
480		C 189	C 1	R: 10.0 cm H: 2.6 cm B: 4.9 cm		Ware: medium fine buff. Temper: grit and chaff. Surface: smoothed. Profile.
481		C 601	C 1-2	R: 9.3 cm H: 3.0 cm		Ware: medium coarse grey. Temper: much fine white grit and chaff. Profile.
482		C 602	Topsoil	R: 9.6 cm H: 2.7 cm B: 6.0 cm		Ware: medium coarse pink to white. Temper: some grit and chaff. Profile.
483		C 504	C 1	R: 11.4 cm H: 4.1 cm B: 5.9 cm	A LA C 1	Ware: medium coarse red. Temper: grit and chaff. Traces of burning at one point on rim. Profile.
484		C 254	C 2-3	R: 12.6 cm H: 4.4 cm B: 4.0 cm	C 1	Ware: medium fine salmon-pink. Temper: grit and chaff. Profile.
485		C 98	C 1	R: 17.2 cm H: 6.8 cm B: 5.7 cm	C 1	Ware: medium pink to white. Temper: grit and chaff. Profile.
486		C 258	C 1	R: 16.4 cm H: 5.0 cm B: 6.8 cm	C 1	Ware: medium fine brown with grey core. Temper: grit and chaff. Surface: bitumen traces inside and out. Profile.
487		C	C 1	R: 15.4 cm H: 4.4 cm B: 5.8 cm	C 1	Ware: fine green with grey core. Temper: grit and chaff. Overfired and warped. Profile.
488		A 303	A 1	R: 15.4 cm H: 4.8 cm B: 6.5 cm	C 1	Ware: fine red. Temper: small white grit and chaff. Surface: highly burnished inside and out. Profile.
489		C 208	C 1	R: 18.4 cm H: 4.3 cm B: 7.7 cm	C 1	Ware: medium fine pink to white. Temper: fine grit. Surface: lightly burnished inside. Profile.
490		B	B LA	R: 18.4 cm H: 4.3 cm B: 9.2 cm	C 1	Ware: medium fine buff to orange. Temper: grit and chaff. Profile.
491		C	C 1	R: 23.6 cm H: 5.5 cm B: 8.0 cm		Ware: fine pink-buff. Temper: fine grit. Surface: lightly burnished inside. Profile.

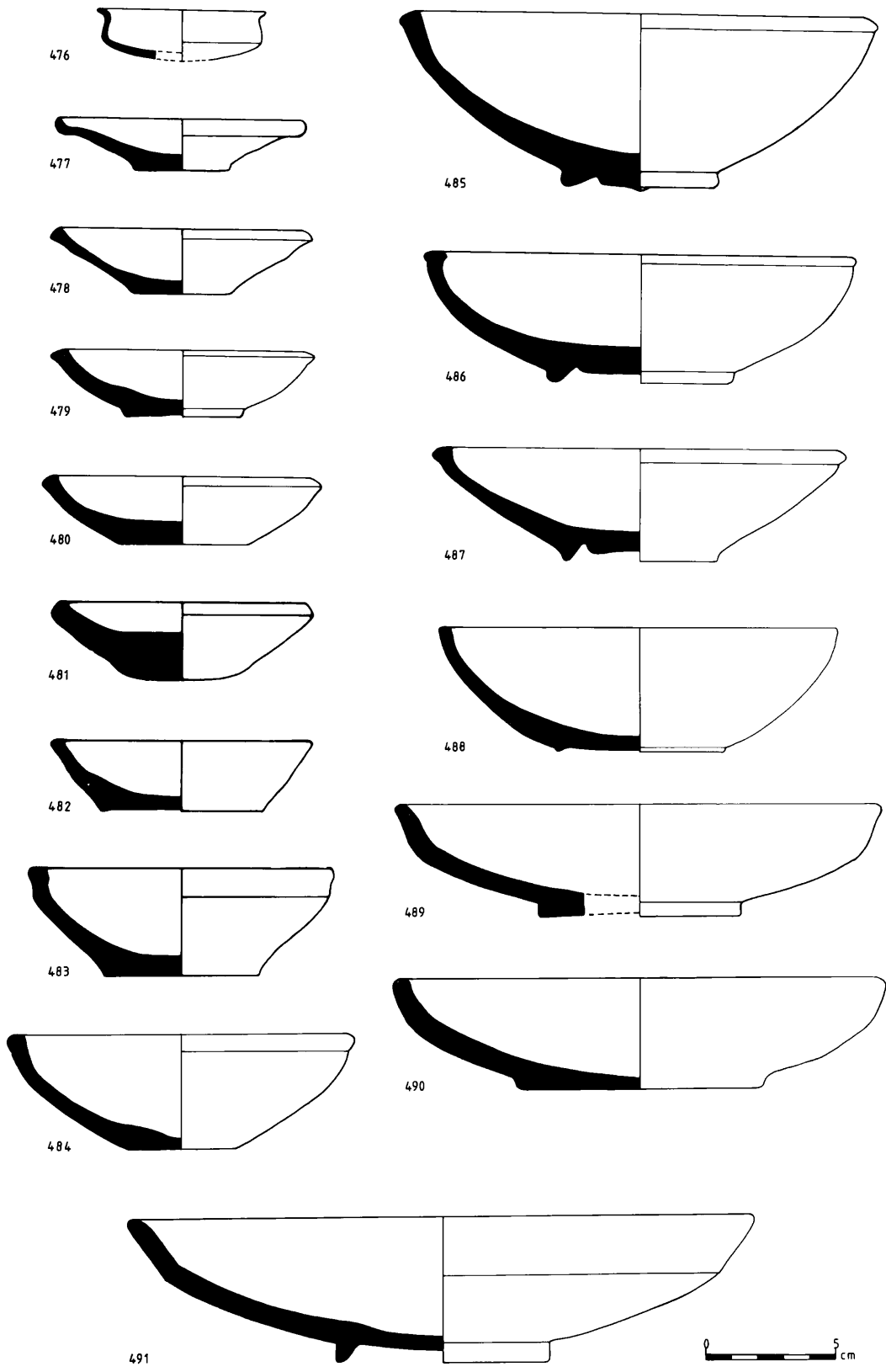

PLATE 56

BOWLS – LATE ASSYRIAN

Pot No	TR No	Batch	Level	Dimensions	Range	Ware and Remarks
492		C 219 CG 8-68	C 1	R: 30.5 cm H: 21.7 cm B: 9.0 cm	C 1-2	Ware: medium coarse salmon-pink. Temper: grit and chaff. Bowl inverted over jar containing body. Almost complete.
493	5014	C 165	C 1	R: 26.5 cm H: 15.1 cm B: 9.0 cm	A LA C 1-3	Ware: medium coarse orange-buff. Temper: white grit and chaff. Base: hole mended in antiquity with small potsherd set in bitumen. Complete.
494		C 615	C 1	R: 22.5 cm H: 10.2 cm B: 7.8 cm	A LA C 1	Ware: coarse yellow. Temper: grit and chaff. Surface: vertical burnishing marks outside below carination, possibly originally also burnished inside. Profile.
495		A 592	A LA	R: 21.0 cm H: 9.3 cm B: 9.0 cm	C 1-2	Ware: medium fine orange-buff. Temper: grit and chaff. Surface: very well smoothed. Bitumen coating inside. Profile.
496		C 504	C 1	R: 14.0 cm H: 5.5 cm B: 7.6 cm	C 1	Ware: fine orange. Temper: grit and some chaff. Slip: red on rim and inside. Surface: highly burnished only on red slip on rim. Base: two of originally three feet extant. Profile.
497		C 184	C 1	R: 22.0 cm H: 7.7 cm B: 8.8 cm	A LA C 1-2	Ware: fine buff. Temper: grit and chaff. Slip: red on rim and splashes inside. Surface: burnished only on red slip on rim. Profile.
498		C	C 1	R: 13.0 cm H: 4.2 cm B: 5.4 cm	C 1-2	Ware: fine red. Temper: grit. Surface: very smooth, almost burnished. Profile.
499		C 614	Topsoil	R: 15.0 cm H: 3.4 cm B: 9.0 cm	C 1	Ware: fine green. Temper: some large white grit and chaff. Surface: burnished on rim and inside, with radiating marks from carination to centre of bowl. Profile.
500		B	B LA	R: 15.0 cm H: 3.5 cm	A LA	Ware: fine yellow-buff. Temper: grit and chaff. Surface: well smoothed. Base: missing. Rim sherd.
501		C	C 1	R: 20.0 cm H: 5.2 cm B: 8.6 cm	C 1	Ware: medium fine salmon-pink. Temper: grit and chaff. Surface: smoothed. Profile.
502		C 509	C 1	R: 14.0 cm H: 3.9 cm		Ware: fine black with grey core. Temper: grit. Surface: highly burnished inside and out. One broad lug on sherd, possibly two originally. Base: missing. Rim sherd.
503		C 926	Topsoil	R: 15.0 cm H: 3.7 cm	C 1	Ware: fine orange. Temper: grit. Slip: red outside and in for 1 cm. Surface: well burnished on red slip. Base: missing. Rim sherd.
504		C 184 C 504	C 1	R: 21.0 cm H: 18.6 cm		Ware: medium coarse red. Temper: grit and chaff. Lugs: four extant, probably originally six. Base: missing. Upper profile.
505	5012	C 198	C 1	R: 24.0 cm H: 21.5 cm B: 10.5 cm	C 1-2	Ware: medium fine pink-buff. Temper: white grit and chaff. Paint: red. Handles: two strap (one extant). Lugs: eight (four extant). Profile.

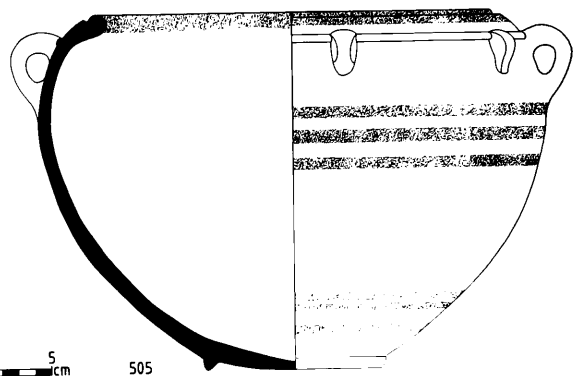
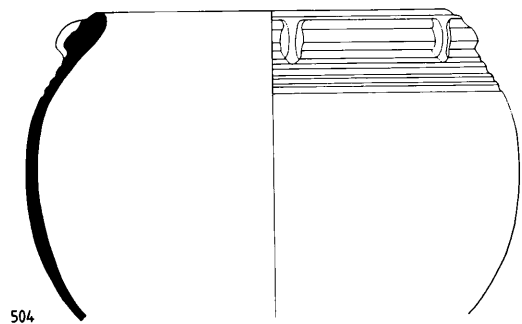
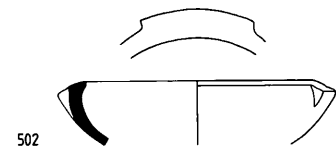
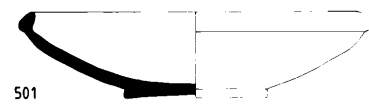
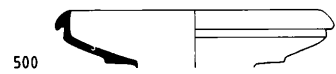
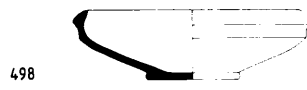
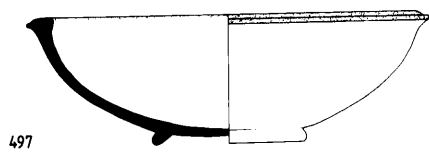
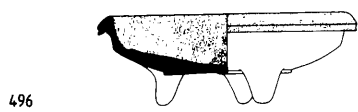
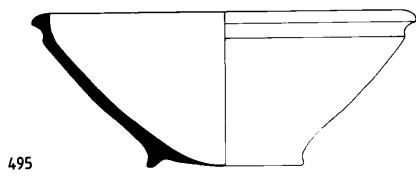
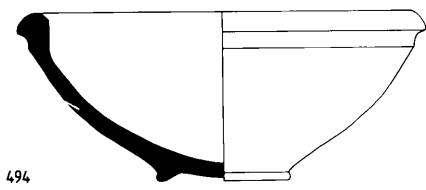
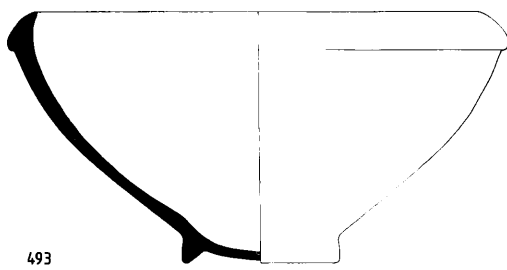
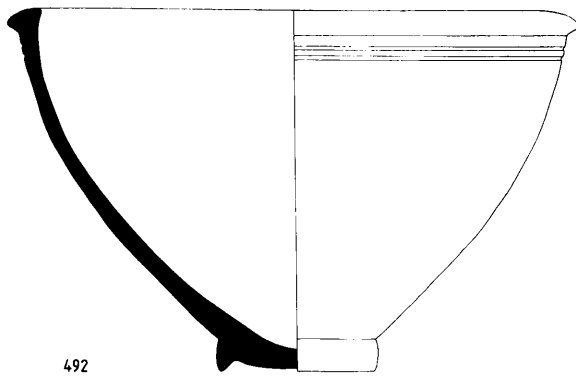
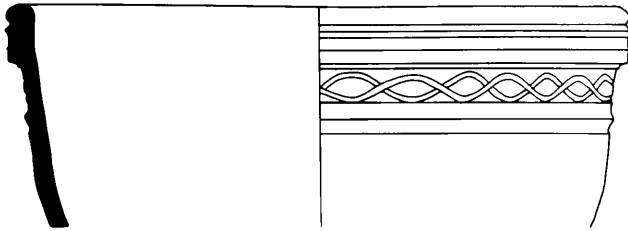

PLATE 57

INCISED AND DECORATED VESSELS

Pot No	TR No	Batch	Level	Dimensions	Range	Ware and Remarks
506		C 732	C 4	R: 48.0 cm H: 17.8 cm	A 1-2a	Ware: medium coarse buff. Temper: grit and chaff. Surface: smoothed outside. Decoration: multiple ribs and incised double wavy lines below rim. Base: missing. Rim sherd.
507		C 702	C 4	R: 63.0 cm H: 20.0 cm	A 1 C 1-4	Ware: medium coarse red to white. Temper: grit and chaff. Decoration: cable patterns on rim and side of rim consist of raised bands with diagonal slashes. Cable pattern on side of bowl is an applied band with finger-impressions. Base: missing. Rim sherd.
508		C 67	C 5	R: 26.0 cm H: 19.0 cm		Ware: medium fine pale brown to cream. Temper: little grit. Surface: burnished outside with vertical strokes on neck and horizontal strokes on body. Base: missing. Rim sherd.
509		A 407	A 2	R: 27.4 cm H: 15.0 cm		Ware: coarse green-buff. Temper: grit and chaff. Decoration: incisions on raised bands. Base: missing. Rim sherd.
510		A 473	A 1	R: 20.0 cm H: 12.5 cm		Ware: coarse grey. Temper: grit and chaff. Decoration: applied cable with incised design below. Base: missing. Rim sherd.
511	2115	A 284 A 285	A 1	R: 32.0 cm H: 43.2 cm B: 19.0 cm	A 1	Ware: medium coarse pink to green. Temper: grit and chaff. Decoration: horizontal ribs, one marked with impressed crescents. Almost complete.



506

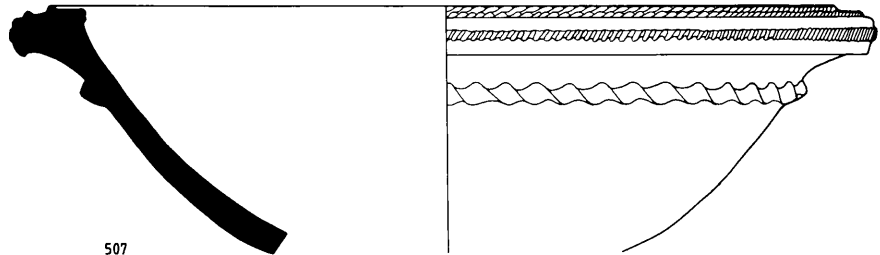
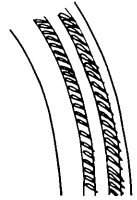

507

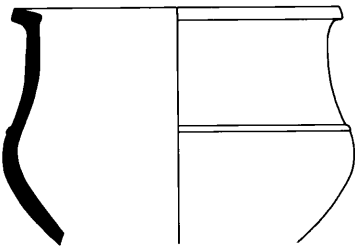

508

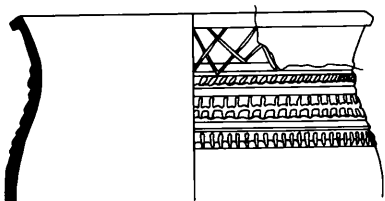

509

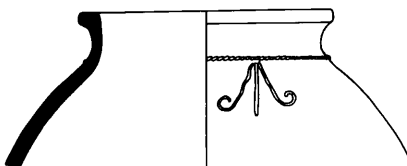

510

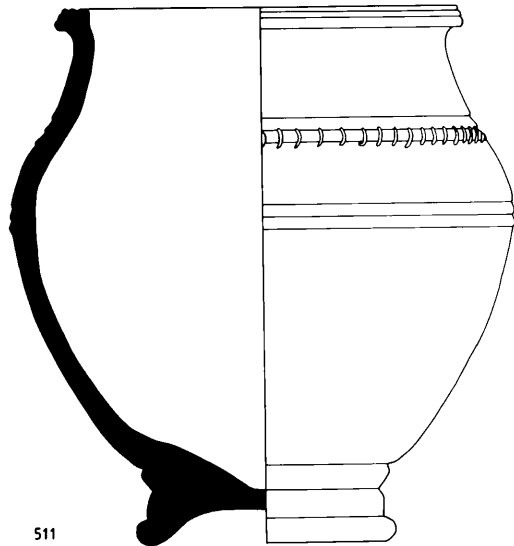

511



PLATE 58

RED-PAINTED BOWLS – OLD BABYLONIAN

Pot No	TR No	Batch	Level	Dimensions	Range	
512		A 462 A 498	A 3 late	R: 16.8 cm H: 6.1 cm	A 2c-3 C 5-6	Ware: fine buff. Temper: grit. Base: rounded. Paint: red horizontal bands and vertical stripes outside, concentric circles inside on base. Profile. Plate 19c
513		A	A 2b	R: 17.5 cm H: 4.3 cm	A 3	Ware: fine pale buff. Temper: grit. Paint: black horizontal bands and cross-hatching, with traces of vertical lines above. Base: broken. Profile.
514		C 20 C 29	C 6a	R: 14.0 cm H: 2.9 cm		Ware: fine buff. Temper: fine grit. Paint: dark brown horizontal band and solid triangles outside, splashes of paint inside. Rim and base missing. Bodysherd.
515		A 739	A 3	R: 14.0 cm H: 4.0 cm		Ware: fine pale grey-buff. Temper: fine grit. Paint: dark red-brown band on outside of rim and band of paint in base cut off by the break. Base: missing. Rim sherd.
516		C 420	C 6	R: 14.4 cm H: 5.9 cm B: 4.5 cm		Ware: fine light brown-buff. Temper: grit and some chaff. Paint: dark brown unevenly applied in rough triangles on outside of rim. Profile.
517		A 565	A 3	R: 14.1 cm H: 5.5 cm B: 4.2 cm	A 3 C 6-7	Ware: fine yellow-buff. Temper: grit and chaff. Paint: faded red in sets of three strokes on rim and splashes of paint inside. Profile.
518	4124	C 83	C 5b	R: 13.0 cm H: 5.2 cm B: 4.1 cm	A 3 C 6	Ware: fine pink-buff. Temper: very large white grit. Paint: red in sets of three strokes on rim and splashes of paint inside. Complete.
519	6023	C 686	C 6a	R: 12.2 cm H: 4.7 cm B: 4.1 cm	C 6a	Ware: fine red to white. Temper: large white grit. Paint: brick-red applied in unevenly-spaced strokes on rim and large splashes inside. Trace of burning at one point on rim. Found in Pot 1025. Pot AF <i>Figure 11</i> . Half extant.
520		C 476	C 7	R: 17.0 cm H: 6.4 cm	A 3-4 C 6a-6	Ware: medium fine green. Temper: grit and chaff. Warped. Paint: red strokes on rim, very worn. Profile.
521		A 608 A 609	A 4	R: 18.0 cm H: 8.8 cm B: 5.8 cm	A 4 C 5-6	Ware: medium fine orange-buff. Temper: white grit and chaff. Paint: brown strokes on rim, irregularly-spaced. Profile.

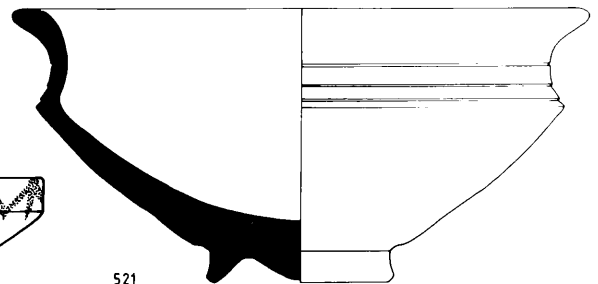
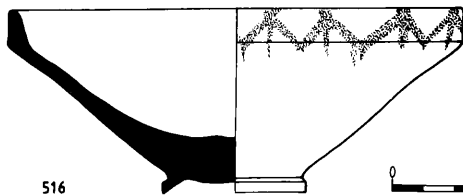
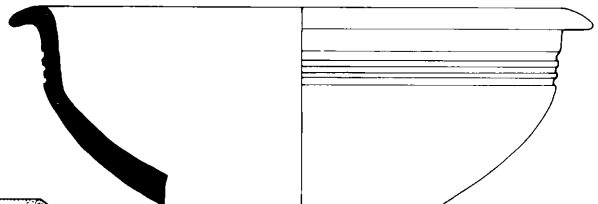
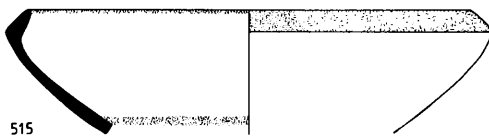
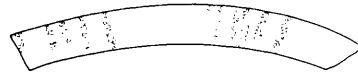
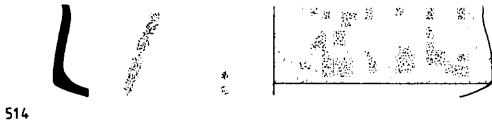
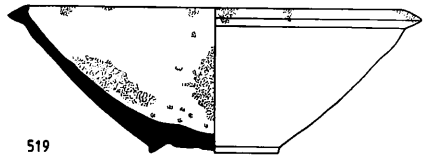
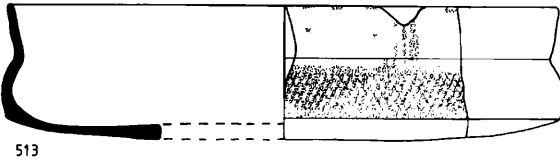
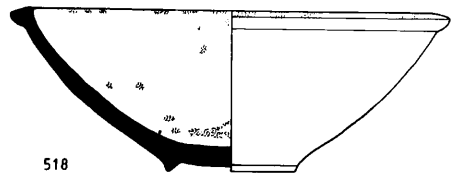
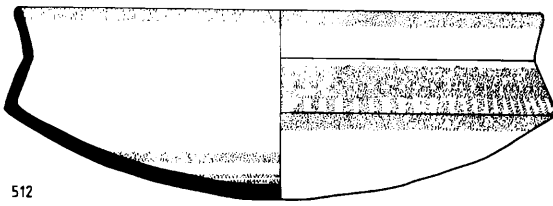
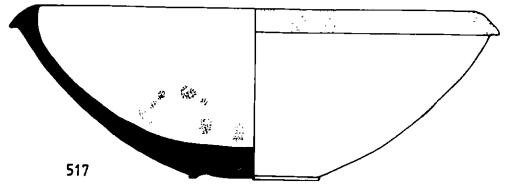
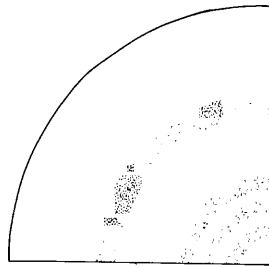
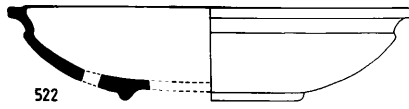

PLATE 59

LATE THIRD AND EARLY SECOND MILLENNIUM POTTERY

Pot No	TR No	Batch	Level	Dimensions	Range	Ware and Remarks
522		A 701	A 4	R: 24.0 cm H: 5.6 cm	A 5 C 6-7	Ware: fine pale grey. Temper: grit and some chaff. Reconstructed profile.
523		A 604	A 4	R: 18.0 cm H: 5.8 cm	A 4 C 5-7	Ware: medium coarse buff to white. Temper: grit and chaff. Base: missing. Rim sherd.
524		A 663	A 6	R: 9.8 cm H: 3.4 cm	A 3-4 C 6-7	Ware: medium fine salmon-pink to white. Temper: grit and some chaff. Base: missing. Rim sherd.
525		A 677	A 4	R: 11.6 cm H: 2.9 cm	A 1-3	Ware: medium fine buff. Temper: white grit and chaff. Base: missing. Rim sherd.
526		A 694	A 4	R: 12.8 cm H: 4.2 cm	A 1-4 C 2	Ware: fine cream. Temper: fine grit. Decoration: incised combed wavy line below rim out. Base: missing. Rim sherd.
527		A 702	A 5	R: 19.0 cm H: 6.3 cm	A 3-6	Ware: very fine white to green, with a definite colour change in the ware about 3.5 cm below rim. Temper: grit. Base: missing. Rim sherd.
528		A 718	A 5	R: 16.5 cm H: 4.6 cm	A 3-6 C 2-4	Ware: very fine hard-fired dark green. Temper: fine grit. Base: missing. Rim sherd.
529		A 702 A 718	A 5	R: 18.2 cm H: 5.5 cm	A 3-6	Ware: very fine cream to buff. Temper: fine grit. Base: missing. Rim sherd.
530		A 692	A 4	D: 13.8 cm H: 7.3 cm		Ware: very fine buff to white. Temper: fine grit. Rim: missing. Base sherd.
531		A 700	A 5	D: 10.0 cm H: 8.5 cm		Ware: medium coarse red. Temper: grit and chaff. Decoration: incised combed lines. Rim: missing. Base sherd.
532		A 727	A 6	R: 8.4 cm H: 7.2 cm	A 5-6	Ware: very fine green. Temper: grit. Base: missing. Rim sherd.
533		A 663	A 6	R: 9.0 cm H: 6.2 cm		Ware: medium coarse pink-buff. Temper: grit and some chaff. Base: string-cut. Profile.
534		A 702	A 5	R: 8.4 cm H: 7.3 cm		Ware: medium fine red. Temper: white grit and chaff. Profile.
535		A 702	A 5	R: 6.7 cm H: 5.0 cm		Ware: medium coarse dark brown. Temper: chaff. Hand-made. Base: missing. Rim sherd.
536		A 685	A 5	R: 5.8 cm H: 4.7 cm		Ware: fine hard-fired pale green. Temper: fine grit. Surface: lightly burnished. Base: missing. Rim sherd.
537		A 670	A 3	R: 7.8 cm H: 8.8 cm	C 6	Ware: fine hard-fired buff. Temper: grit. Profile.
538		A 727	A 6	R: 11.0 cm H: 10.0 cm		Ware: medium fine buff to pale green. Temper: grit and chaff. Decoration: three irregular grooves. Base: missing. Rim sherd.
539		A 702	A 5	R: 12.8 cm H: 14.7 cm		Ware: edium coarse green. Temper: some grit and chaff. Roughly made and overfired. Profile.
540		A 634	A 4	R: 19.0 cm H: 9.6 cm	C 6-7	Ware: medium coarse pink-brown. Temper: some grit and chaff. Decoration: comb-impressed band. Surface: plaster lining inside. Base: missing. Rim sherd.
541		A 634	A 4	R: 18.5 cm H: 6.7 cm	C 6	Ware: medium fine white to salmon-pink. Temper: grit and chaff. Base: missing. Rim sherd.
542		A 634	A 4	R: 8.8 cm H: 6.4 cm	A 1-4 C 1-7	Ware: very fine hard-fired green. Temper: grit. Profile.
543		A 651	A 4	R: 8.3 cm H: 4.6 cm		Ware: fine light brown. Temper: grit. Base: missing. Rim sherd.
544		A 650	A 4	D: 9.7 cm H: 6.4 cm		Ware: fine buff. Temper: white grit. Surface: burnished with vertical marks towards base, horizontal marks above carination. Rim: missing. Base sherd.
545		A 636	A 4	R: 9.0 cm H: 4.8 cm		Ware: fine light cream to green. Temper: grit. Surface: lightly burnished out. Base: missing. Rim sherd.
546		A 702	A 5	R: 10.6 cm H: 6.9 cm	A 5	Ware: fine dark grey. Temper: some grit and chaff. Surface: well smoothed. Base: flat disc base of same pot found with it. Rim sherd.
547	5026	A 722 AG 3-68	A 5	R: 6.3 cm H: 13.4 cm		Ware: medium coarse red. Temper: fine grit. Almost complete.



522

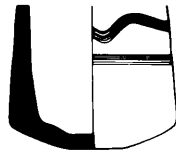

531

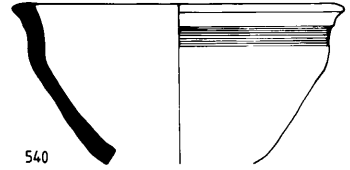

540

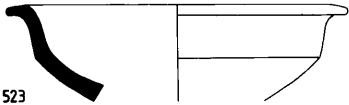

523

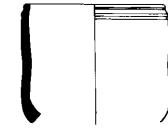

532

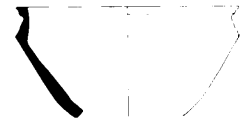

541



524

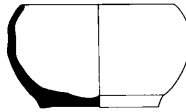

533

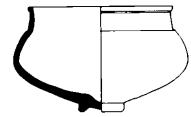

542

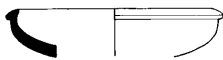

525



534

543

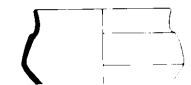

543



526



535

544



544



536

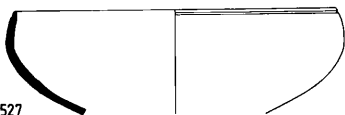

527

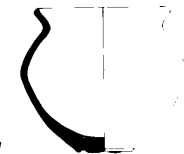

537

545

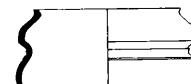

545



528

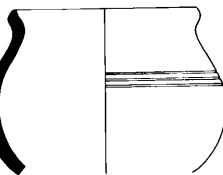

538

546

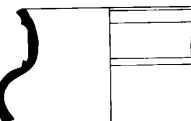

546



529



539

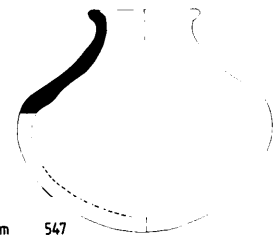

547

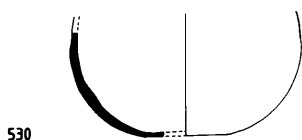

530



PLATE 60

LATE THIRD MILLENNIUM POTTERY

Pot No	TR No	Batch	Level	Dimensions	Range	Ware and Remarks
548		A 702	A 5	R: 54.0 cm H: 17.8 cm	C 7	Ware: coarse buff. Temper: grit and chaff. Decoration: incised triangles, two raised ribs with diagonal slashes and four broad grooves. Base: missing. Rim sherd.
549		C 52	C 6	R: 27.0 cm H: 6.0 cm	C 4-6	Ware: medium coarse yellow to buff. Temper: grit and chaff. Decoration: a row of triple stamped roundels and rib with multiple grooves. Base: missing. Rim sherd.
550		A 671	A 4	R: 20.2 cm H: 13.5 cm	C 4-6a	Ware: medium coarse buff. Temper: grit and chaff. Decoration: four grooves on shoulder. Base: missing. Rim sherd.
551		A 602	A 4	R: 15.6 cm H: 5.9 cm	C 6	Ware: mediumcoarse buff. Temper: fine grit and some chaff. Surface: smoothed. Decoration: deep groove on rim with diagonal slashes. Raised bands with slashes and incised cross-hatching below. Base: missing. Rim sherd.
552		A 732	A 6	R: 15.0 cm H: 5.0 cm		Ware: coarse pale green. Temper: grit and chaff. Decoration: fine incised hatched triangles. Base: missing. Rim sherd.
553		A 702	A 5	R: 16.0 cm H: 8.8 cm		Ware: medium coarse buff. Temper: some large white grit and chaff. Decoration: raised bands with herring-bone slashes. Base: missing. Rim sherd.
554		A 727	A 6	R: 8.4 cm H: 3.9 cm		Ware: fine cream. Temper: fine grit. Decoration: incised combing at base of neck. Bodysherd of possibly the same jar also has rows of comb-impressed dots. Rim and body sherds.
555		A 404	A 3-4	R: 12.0 cm H: 3.0 cm		Ware: fine red-buff. Temper: grit and chaff. Decoration: incised herring-bone slashes. Base: missing. Rim sherd.
556		A 595	A 3	R: 12.6 cm H: 7.5 cm	C 7	Ware: coarse buff. Temper: chaff. Decoration: incised wavy line. Base: missing. Rim sherd.
557		C 408	C 6	D: 25.0 cm H: 6.0 cm	C 7	Ware: medium fine cream. Temper: grit and some chaff. Paint: dark brown, fragmentary, the pattern is therefore partly reconstructed. Bodysherd.
558		C 62	C 6	H: 7.5 cm	A LA-4 C 1-7	Ware: medium coarse buff. Temper: grit and chaff. Paint: thick dull red. The pattern has been expanded in the drawing for clarity. Some of the horizontal lines are painted over ribs or grooves. Bodysherd.
559		A 403	A 3-4	R: 29.0 cm H: 9.5 cm	A 2a-3 C 6a-7	Ware: medium coarse buff. Temper: white grit and chaff. Paint: brown. Horizontal grooves under painted pattern. Base: missing. Rim sherd. Plate 19a
560		A 565	A 3	R: 25.5 cm H: 13.5 cm	C 6a	Ware: coarse buff. Temper: grit and chaff. Paint: dark red strokes on rim and splashes inside. Base: missing. Rim sherd. Plate 19a
561		A 624	A 3	R: 22.5 cm H: 11.2 cm	A 2-3 C 6a-6	Ware: medium fine salmon-pink. Temper: grit and chaff. Paint: dark brown bands and splashes inside. Base: missing. Rim sherd.
562		A 565	A 3	R: 15.8 cm H: 8.0 cm	A 2 C 6	Ware: medium coarse orange-buff. Temper: grit and chaff. Paint: orange-red bands. Base: missing. Rim sherd.
563		A 410	A 4	R: 17.8 cm H: 6.2 cm	A 3 C 6a-6	Ware: medium coarse buff. Temper: chaff. Paint: black to red bands and hatched triangles. Base: missing. Rim sherd. Plate 19a
564		A 453	A 3	R: 13.8 cm H: 7.0 cm		Ware: fine grey-buff. Temper: grit and chaff. Paint: red. Decoration: raised bands with incised slashes. Base: missing. Rim sherd. Plate 19c
565		A 709	A 3	R: 14.0 cm H: 5.5 cm		Ware: fine cream. Temper: grit and some chaff. Paint: dark brown bands and splashes inside. Base: missing. Rim sherd.
566		A 605	A 4	R: 11.8 cm H: 7.5 cm	A 3 C 4-6a	Ware: medium fine buff. Temper: grit and chaff. Paint: black, irregularly applied in bands on shoulder, neck and on rim. Base: missing. Rim sherd.

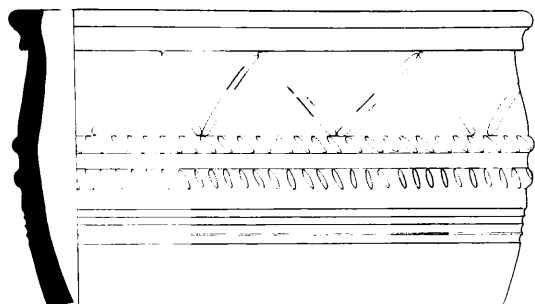

548

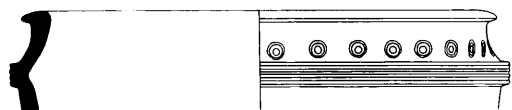

549

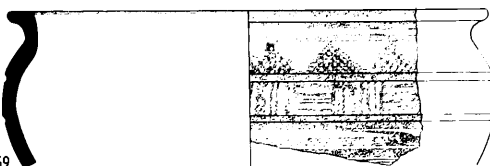

559

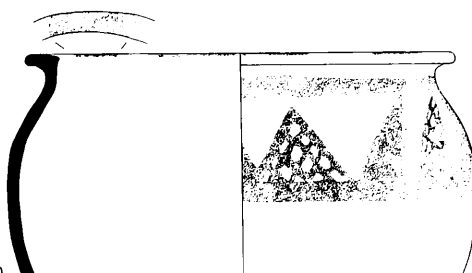

560

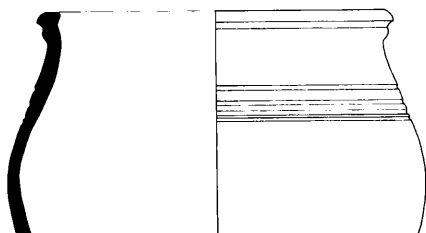

550

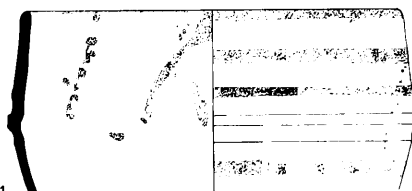

561

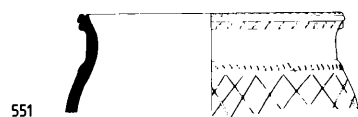

551



555

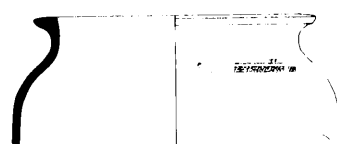

562

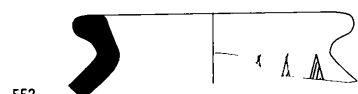

552

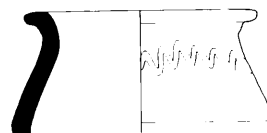

556

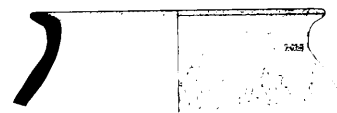

563

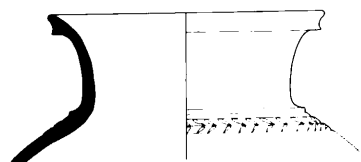

553

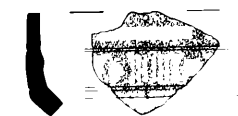

557

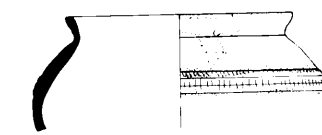

564

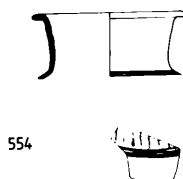

554

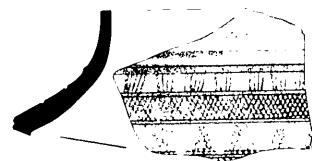

558

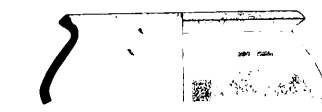

565



566



PLATE 61

HOLE-MOUTH BOWLS

Pot No	TR No	Batch	Level	Dimensions	Range	Ware and Remarks
567		A 242	A 1	R: 40.0 cm H: 17.2 cm B: 14.0 cm	C 1-4	Ware: medium coarse dark buff to cream. Temper: grit and chaff. Profile.
568		A 42	A 1	R: 34.0 cm H: 10.5 cm B: 12.0 cm	A 1-2 C 1-4	Ware: medium coarse red. Temper: grit and a little chaff. Surface: well smoothed. Profile.
569		A 71	A 1	R: 26.0 cm H: 9.7 cm B: 12.3 cm	A Tops C 4	Ware: medium fine red to grey. Temper: grit and a little chaff. Profile.
570		A 233	A 1	R: 22.7 cm H: 10.4 cm B: 9.3 cm	C 1-5	Ware: medium coarse buff. Temper: grit and chaff. Profile.
571		A 473	A 1	R: 19.8 cm H: 10.9 cm B: 7.3 cm	A 1-2 C 1-5	Ware: medium coarse green-buff. Temper: grit and chaff. Profile.
572		A 352	A 2a-b	R: 18.0 cm H: 12.2 cm B: 8.8 cm	A 2-3 C 2-5	Ware: coarse buff. Temper: grit and chaff. Overfired. Profile.
573		A 342	A 2a	R: 22.5 cm H: 9.3 cm B: 8.7 cm	A 2 C 1-5b	Ware: medium coarse buff. Temper: chaff. Surface: well smoothed. Found covering "scaffold-hole" and knuckle-bone deposit in the middle of Room 16. Profile.
574		C 937	C 4	R: 18.7 cm H: 8.4 cm B: 8.8 cm	C 1-5	Ware: medium coarse red. Temper: some large white grit and chaff. Profile.
575		A 272	A 2	R: 23.0 cm H: 10.8 cm	C 2	Ware: medium coarse buff. Temper: grit and chaff. Surface: heavy incrustation of bitumen inside. Decoration: raised bands with diagonal slashes. Base: missing. Rim sherd.
576		A 563	A 2	R: 26.0 cm H: 8.1 cm	A 2b C 1-3	Ware: medium coarse orange to white. Temper: grit and chaff. Decoration: raised band with deep vertical slashes. Base: missing. Rim sherd.
577		A 307	A 2a-b	R: 26.5 cm H: 10.0 cm	A 1-2 C 2-3	Ware: medium coarse buff to orange. Temper: grit and chaff. Surface: well smoothed. Decoration: raised band with diagonal slashes. Base missing. Rim sherd.
578		A 291	A 2a-b	R: 28.2 cm H: 13.4 cm B: 8.7 cm	A 1-2 C 3-4	Ware: coarse buff. Temper: chaff. Decoration: plain applied band. Profile.

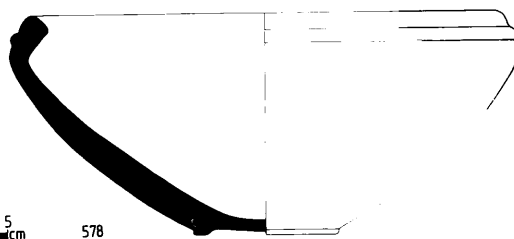
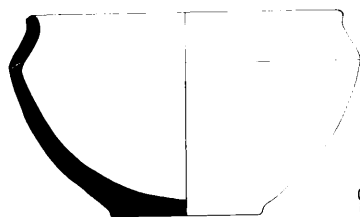
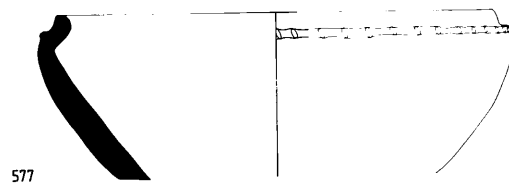
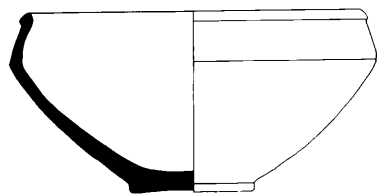
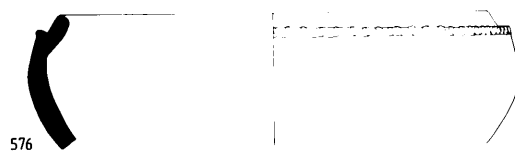
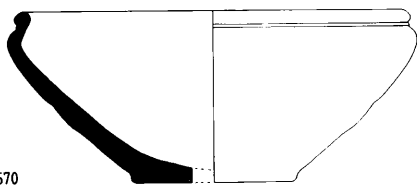
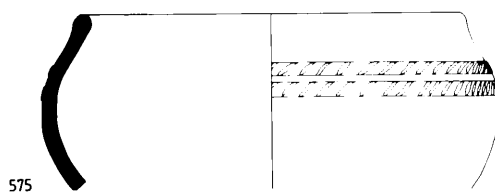
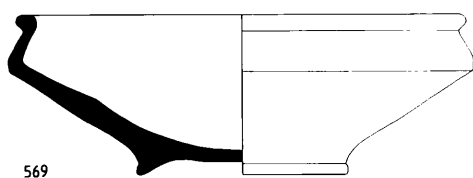
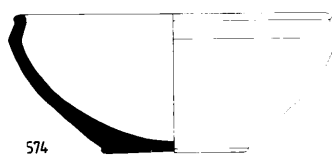
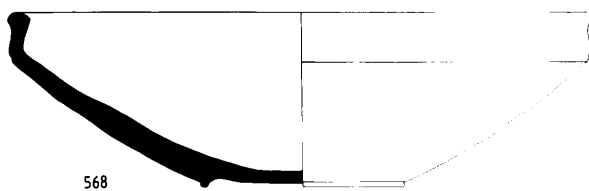
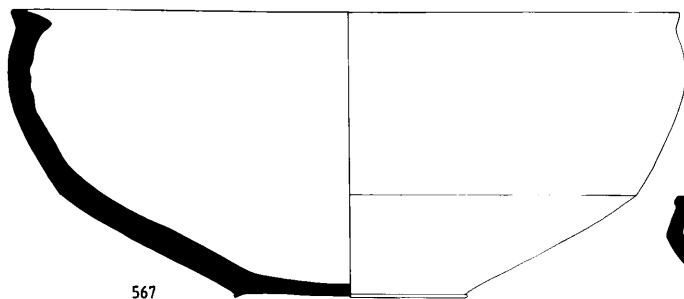

PLATE 62

HOLE-MOUTH BOWLS

Pot No	TR No	Batch	Level	Dimensions	Range	Ware and Remarks
579		C	Topsoil	R: 34.0 cm H: 17.3 cm B: 11.8 cm	A 1-2 C 1-5	Ware: coarse dark buff to red. Temper: chaff. Surface: smoothed. Profile.
580		C 649	C 4	R: 21.3 cm H: 14.1 cm B: 10.4 cm	A 2c C 4-5	Ware: medium coarse buff fired red to white in places. Temper: grit and chaff. Surface: rough inside below higher carination. Profile.
581		C 677	C 5	R: 19.3 cm H: 11.6 cm B: 10.8 cm	C 1-6	Ware: medium coarse buff. Temper: grit and chaff. Base: outer surface covered with a layer of plaster. Profile.
582		C 697	C 6	R: 18.5 cm H: 11.5 cm B: 10.7 cm	C 4-5	Ware: medium coarse pale buff. Temper: grit and chaff. Surface: well smoothed. Profile.
583		A 289	A 1	R: 20.0 cm H: 9.6 cm B: 9.1 cm	A 1-2 C 4-5	Ware: coarse green-buff. Temper: chaff. Profile.
584	6010	C 647	C 5	R: 22.0 cm H: 11.0 cm B: 10.2 cm	A 3 C 1-6a	Ware: medium coarse red-brown. Temper: grit and chaff. Complete.
585		C 223	C 2	R: 22.0 cm H: 9.4 cm B: 12.0 cm	A 2a-b C 1-6a	Ware: medium coarse buff to cream. Temper: grit and chaff. Profile.
586	6009	C 525	C 4	R: 18.8 cm H: 13.1 cm B: 8.8 cm	C 5	Ware: medium coarse green. Temper: grit and chaff. Complete.
587	2134	C	C 1	R: 18.0 cm H: 10.1 cm B: 8.5 cm	A 2c C 1-6	Ware: medium coarse buff. Temper: grit and chaff. Warped. Complete.
588		A 94	A 1	R: 34.4 cm H: 10.8 cm B: 18.8 cm	C 3-6a	Ware: medium fine buff. Temper: grit and chaff. Surface: burnished inside and out. Profile.

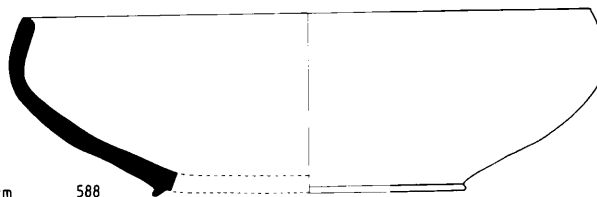
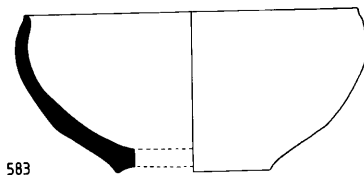
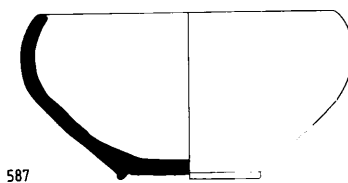
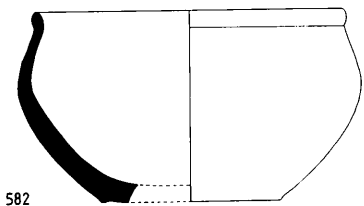
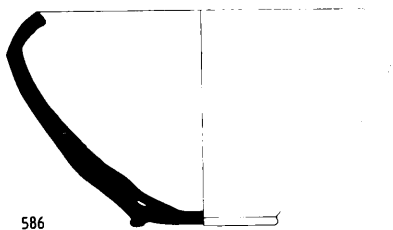
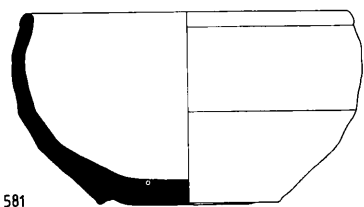
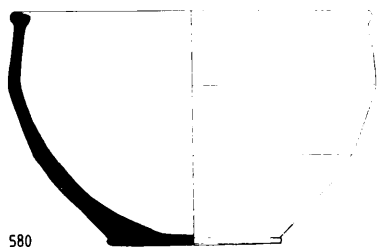
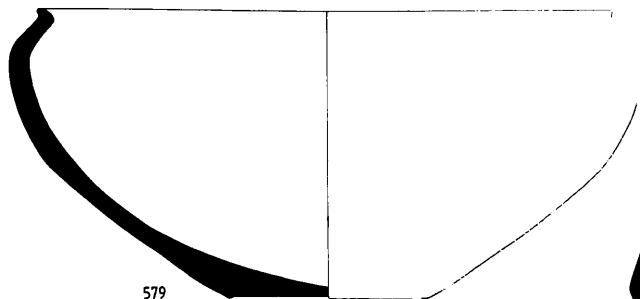

PLATE 63

COOKING POTS AND LATE ASSYRIAN DEEP BOWLS

Pot No	TR No	Batch	Level	Dimensions	Range	Ware and Remarks
589		C 640	C 4	R: 21.5 cm H: 15.8 cm	A 1-3 C 2-5	Ware: red to brown cooking ware with black core. Temper: white grit and mica. Base: missing. Two associated sherds of another cooking-pot may have acted as a base. Pot found upright <i>in situ</i> . Almost complete.
590	5043	C 354	C 4	R: 25.5 cm H: 26.3 cm	A 1-3 C 2-5b	Ware: brown cooking ware, fire-blackened in places. Temper: white grit and mica. Surface: burnished outside with vertical marks from base to shoulder, horizontal from shoulder to rim. Base: broken in antiquity and repaired with a patch made of a sherd from a different pot set with plaster. Almost complete.
591		C 48	C 5	R: 37.2 cm H: 45.0 cm B: 10.6 cm	A 1-3 C 1-6	Ware: black to orange cooking ware. Temper: white grit and mica. Surface: burnished outside. Base: decorated with twenty comma-shaped incisions. Almost complete.
592		C 248 C 270	C 3	R: 43.0 cm H: 40.0 cm	A 1-3 C 3-5	Ware: red-brown cooking ware fire-blackened in places. Temper: white grit and mica. Slip: orange on rim. Surface: lightly burnished outside, highly burnished on rim. Base: missing. Almost complete.
593		C 692	C 5	R: 26.3 cm H: 25.4 cm	A 1-3 C 2-6	Ware: brown cooking ware, fire-blackened in places. Temper: white grit and mica. Surface: burnished on rim and outside down to base. Interior of pot has many iron stains. Profile.
594	6013	C 652	C 5	R: 24.0 cm H: 24.0 cm	A 3 C 4-5	Ware: brown cooking ware. Temper: white grit and mica. Surface: burnished with horizontal marks outside and on rim. Base: broken in antiquity and replaced with the shallow ring-base from another jar, of medium coarse buff ware. Pot found upright <i>in situ</i> . Almost complete.
595		A 484	A 3	R: 25.0 cm H: 25.0 cm	A 3 C 5	Ware: red cooking ware, fire-blackened in places. Temper: white grit and mica. Surface: partly burnished outside. Pots 909 and 911 found inside. Almost complete.
596		A 484	A 3	R: 30.0 cm H: 41.0 cm	A 3-4 C 5-6	Ware: red cooking ware, overfired. Temper: large white grit and mica. Surface: burnished outside. Some plaster coating inside. Almost complete.

597		A 473	A 1	R: 59.0 cm H: 31.2 cm B: 12.0 cm		Ware: coarse pink-red. Temper: grit and chaff. Profile.
598		DG 13-66	D 2	R: 41.0 cm H: 40.0 cm B: 9.0 cm		Ware: medium coarse pink-buff. Temper: chaff. Base: hole in centre D: 2.4 cm. Almost complete. Plate 17d
599		C 187	C 1	R: 62.0 cm H: 66.5 cm	C 1-3	Ware: coarse grey-buff. Temper: grit and chaff. Surface: bitumen coating on upper part outside and plaster lining overall inside. Profile.
600		C 104	C 1	R: 59.5 cm H: 54.0 cm		Ware: coarse grey-buff. Temper: grit. Surface: thick plaster lining inside and thin plaster lining outside. Profile.
601		C 200 CG 5-68	C 1	R: 64.0 cm H: 69.0 cm		Ware: coarse buff. Temper: grit and chaff. Decoration: raised band with vertical slashes. Part of Late Assyrian triple pot burial with Pots 602 and 603. Almost complete. Plate 18
602		C 200 CG 5-68	C 1	R: 67.0 cm H: 46.0 cm	C 1-3	Ware: coarse buff. Temper: grit and chaff. Surface: thick plaster lining inside. Decoration: raised band with thumb-impressed cable pattern. Complete but for base, removed in antiquity to accommodate burial. Plate 18
603		C 200 CG 5-68	C 1	R: 58.0 cm H: 47.0 cm	C 2-3	Ware: coarse buff. Temper: grit and chaff. Decoration: groove with crescent-shaped incisions. Complete but for base, removed in antiquity to accommodate burial. Plate 18

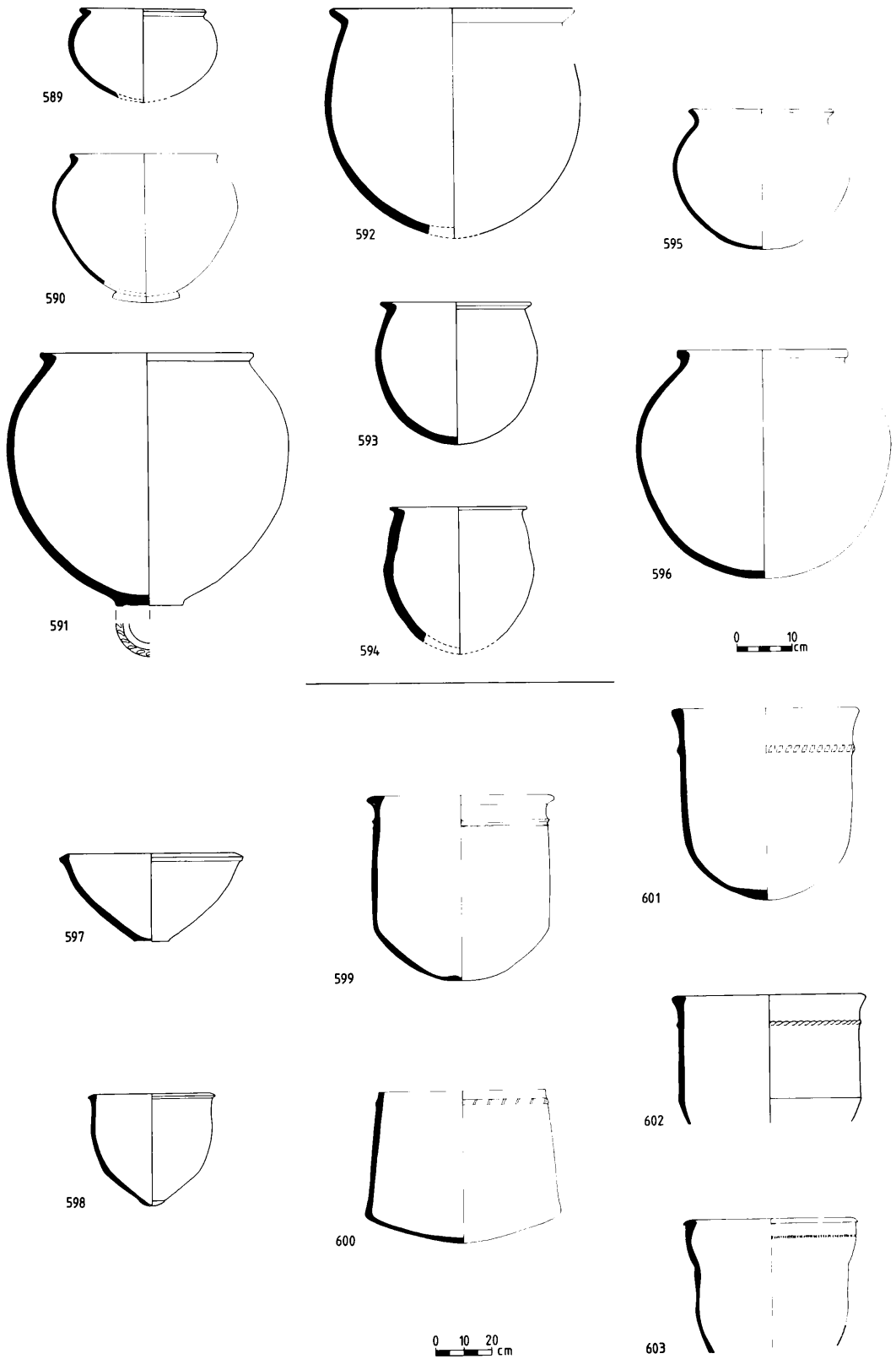

PLATE 64

DEEP BOWLS

Pot No	TR No	Batch	Level	Dimensions	Range	Ware and Remarks
604	6311	C 669	C 4	R: 44.5 cm H: 33.6 cm	A 2-3 C 2-4	Ware: medium coarse green fired red in patches. Temper: large white grit and chaff. Two cylinder-seal impressions on shoulder, rolled while the clay was still wet. Two sherds only, cracks mended in antiquity with much plaster.
605		C 348	C 4	R: 30.0 cm H: 30.0 cm B: 13.5 cm	C 1-5	Ware: coarse buff to pink. Temper: grit and chaff. Profile.
606	6012	C 617	C 3-4	R: 30.5 cm H: 26.8 cm B: 12.5 cm	C 2-6a	Ware: medium coarse brown. Temper: grit and chaff. Slightly warped. Decoration: incised cross on one side drawn over horizontal groove. Almost complete.
607	6011	C 617	C 3-4	R: 30.5 cm H: 24.8 cm B: 12.5 cm	A 3 C 1-6	Ware: coarse green. Temper: grit and chaff. Warped. Almost complete.
608		C 597	C 6a	R: 24.5 cm H: 21.0 cm B: 12.6 cm	A 2b-3 C 2-6a	Ware: medium coarse green. Temper: grit and chaff. Profile.
609		C 1006	C 5	R: 29.0 cm H: 16.0 cm B: 11.6 cm	A 3	Ware: medium coarse green. Temper: grit and chaff. Warped. Profile.
610		A 452	A 3 late	R: 30.0 cm H: 15.6 cm B: 17.4 cm		Ware: medium coarse green. Temper: grit and chaff. Profile.
611		A 364	A 3 late	R: 61.0 cm H: 45.0 cm B: 31.0 cm	C 1-5	Ware: coarse green. Temper: chaff. Base: hole in centre D: 2.0 cm. Profile.
612	6000	C 670	C 5	R: 47.0 cm H: 31.0 cm B: 15.0 cm	A 1-3 C 4	Ware: medium coarse green. Temper: grit and some chaff. Decoration: the channel rim has an internal ram's head spout on one side, while opposite it is bridged by a loop with three ridges pierced by two holes. Two applied horizontal bands outside are decorated with vertical slashes. Base: cracked in firing, and mended in antiquity with a plaster coating outside. Almost complete. Plate 20f
613		A 409 A 411 A 412	A 3 late	R: 40.0 cm H: 21.6 cm B: 22.0 cm	A 3-4	Ware: coarse buff. Temper: chaff. Paint: single dark brown band. Profile.
614	4114	A 581	A 3	R: 35.0 cm H: 21.0 cm B: 15.3 cm	A 2a C 4-6a	Ware: coarse buff. Temper: grit and chaff. Contained Pots 615 and 755. Complete.
615	4113	A 581	A 3	R: 26.0 cm H: 19.6 cm B: 13.0 cm		Ware: coarse buff. Temper: grit and chaff. Base: grooved. Found inside Pot 614. Complete.
616		C 312	C 4	R: 23.0 cm H: 21.3 cm B: 8.8 cm		Ware: coarse pale green. Temper: grit and some chaff. Profile.
617		A 555 A 556	A 3	R: 21.8 cm H: 19.8 cm B: 10.8 cm	A 2c-3 C 5-6	Ware: medium coarse green-buff. Temper: grit and chaff. Profile.
618	6035	C 686	C 6a	R: 34.5 cm H: 29.4 cm B: 13.5 cm	A 3 C 5	Ware: medium coarse pink to cream. Base: hole in centre D: 1.8 cm. Very warped. Pot G <i>Figure 11</i> . Almost complete.
619		C 909	C 6	R: 30.5 cm H: 21.3 cm B: 14.0 cm	A 2c-3 C 4-6a	Ware: medium coarse yellow-buff. Temper: grit and chaff. Surface: inside roughly scraped below carination. Profile.
620		A 565	A 3	R: 31.0 cm H: 22.3 cm B: 14.4 cm	A 2c-3	Ware: coarse salmon-pink with grey core. Temper: grit and chaff. Surface: mottled black in places. Profile.
621	5013	A 708	A 4	R: 24.5 cm H: 25.0 cm B: 10.0 cm		Ware: medium coarse dark buff. Temper: white grit and chaff. Paint: dark red-brown, carelessly applied. Decoration: two sets of horizontal combed grooves. Base: hole in centre D: 1.2 cm. Almost complete.

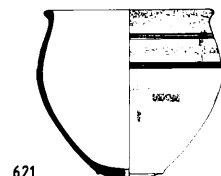
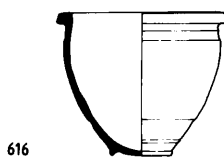
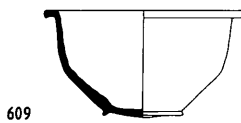
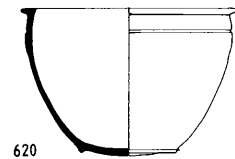
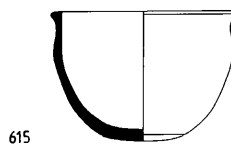
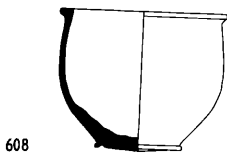
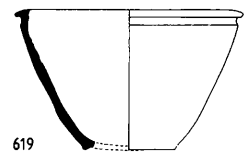
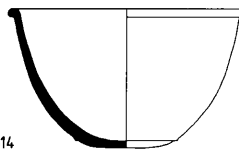
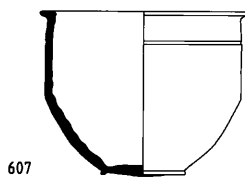
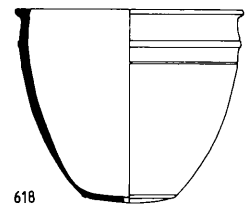
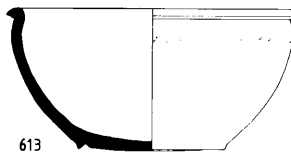
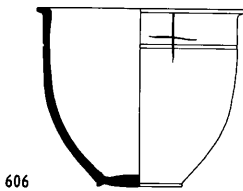
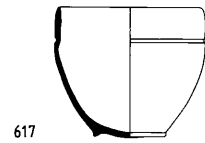
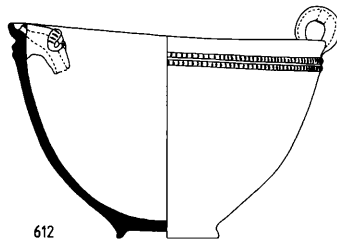
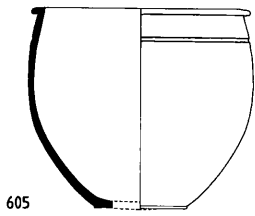
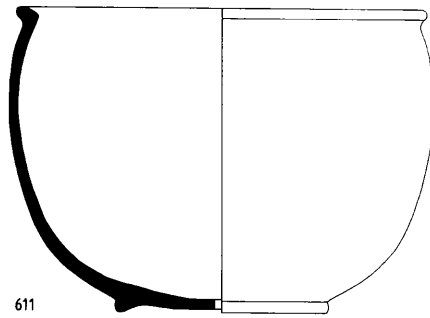
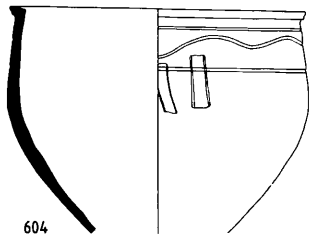

PLATE 65

DEEP BOWLS – OLD BABYLONIAN

Pot No	TR No	Batch	Level	Dimensions	Range	Ware and Remarks
622		C 3	C 2-3	R: 31.0 cm H: 49.2 cm B: 14.0 cm	C 5	Ware: coarse yellow-buff. Temper: grit and chaff. Decoration: horizontal rib and groove with incised wavy line between. Profile.
623		C 569	C 5	R: 56.0 cm H: 50.0 cm B: 15.8 cm	A 2a C2-6a	Ware: medium coarse green. Temper: grit and chaff. Surface: well smoothed outside, rough inside. Decoration: horizontal grooves with incised wavy line between. Base: hole in centre D: 2.5 cm. Profile.
624		C 404	C 6a	R: 61.0 cm H: 54.5 cm B: 21.0 cm	A 3 C 5-6	Ware: coarse buff fired pink in places. Temper: grit. Surface: plaster lining inside. Thick coating of bitumen outside below rim to lower groove showing rope impressions. Decoration: horizontal rib and grooves with incised wavy line between. Base: hole in centre D: 1.0 cm. Profile.
625		A 615	A 3	R: 35.0 cm H: 58.5 cm B: 30.0 cm	A 3 C 5-6	Ware: coarse pale green-buff. Temper: grit and chaff. Decoration: horizontal ribs, combed grooves and applied cable band. Profile.
626	6041	C 686	C 6a	R: 37.0 cm H: 42.2 cm B: 17.0 cm	C 2-6	Ware: medium coarse green. Temper: large white grit and chaff. Decoration: single horizontal groove. Almost complete.
627		A 565	A 3	R: 44.0 cm H: 28.0 cm	C 4-6	Ware: medium coarse cream. Temper: some grit and chaff. Surface: bitumen coating inside. Decoration: horizontal rib and incised wavy line. Base: missing. Upper profile.
628		A 449 A 452	A 3	R: 51.0 cm H: 50.0 cm B: 21.0 cm		Ware: coarse buff to orange. Temper: grit and chaff. Decoration: multiple horizontal grooves and incised wavy line. Profile.
629		A 709	A 3	R: 28.0 cm H: 10.5 cm	A 3	Ware: medium coarse buff to white. Temper: grit and chaff. Decoration: multiple horizontal combed grooves on shoulder. Rim sherd.
630	6044	C 686	C 6a	R: 60.0 cm H: 55.5 cm	A 3 C 6a-6	Ware: medium coarse green. Temper: grit and chaff. Surface: roughly scraped inside. Decoration: horizontal ribs, groove, cable and incised wavy lines. Base: missing, replaced in antiquity with a bodysherd. Pot K <i>Figure 11</i> . Found <i>in situ</i> set in a mud-brick bench. Almost complete.
631	6042	C 686	C 6a	R: 49.0 cm H: 50.2 cm B: 23.0 cm	A 3 C 5-6	Ware: coarse green. Temper: grit and chaff. Surface: smoothed outside, very rough inside. Decoration: horizontal rib, grooves and incised wavy line. Base: hole in centre D: 3.0 cm. Pot J <i>Figure 11</i> . Almost complete.
632	6043	C 673 C 686	C 6a	R: 51.5 cm H: 56.4 cm B: 21.0 cm	C 6a	Ware: medium coarse red. Temper: some large white grit and chaff. Decoration: horizontal raised cable and incised wavy line. Surface: roughly applied zig-zags and verticals possibly drawn with a stick of bitumen. Base: hole in centre D: 2.9 cm. Pot I <i>Figure 11</i> . Found <i>in situ</i> . Almost complete.
633		C 1001	C 6a	R: 50.0 cm H: 41.0 cm	C 6a-6	Ware: medium coarse pink to red. Temper: grit and much chaff. Surface: bitumen coating inside and out with some traces of plaster. Decoration: horizontal groove and raised cable. Base: missing. Profile.

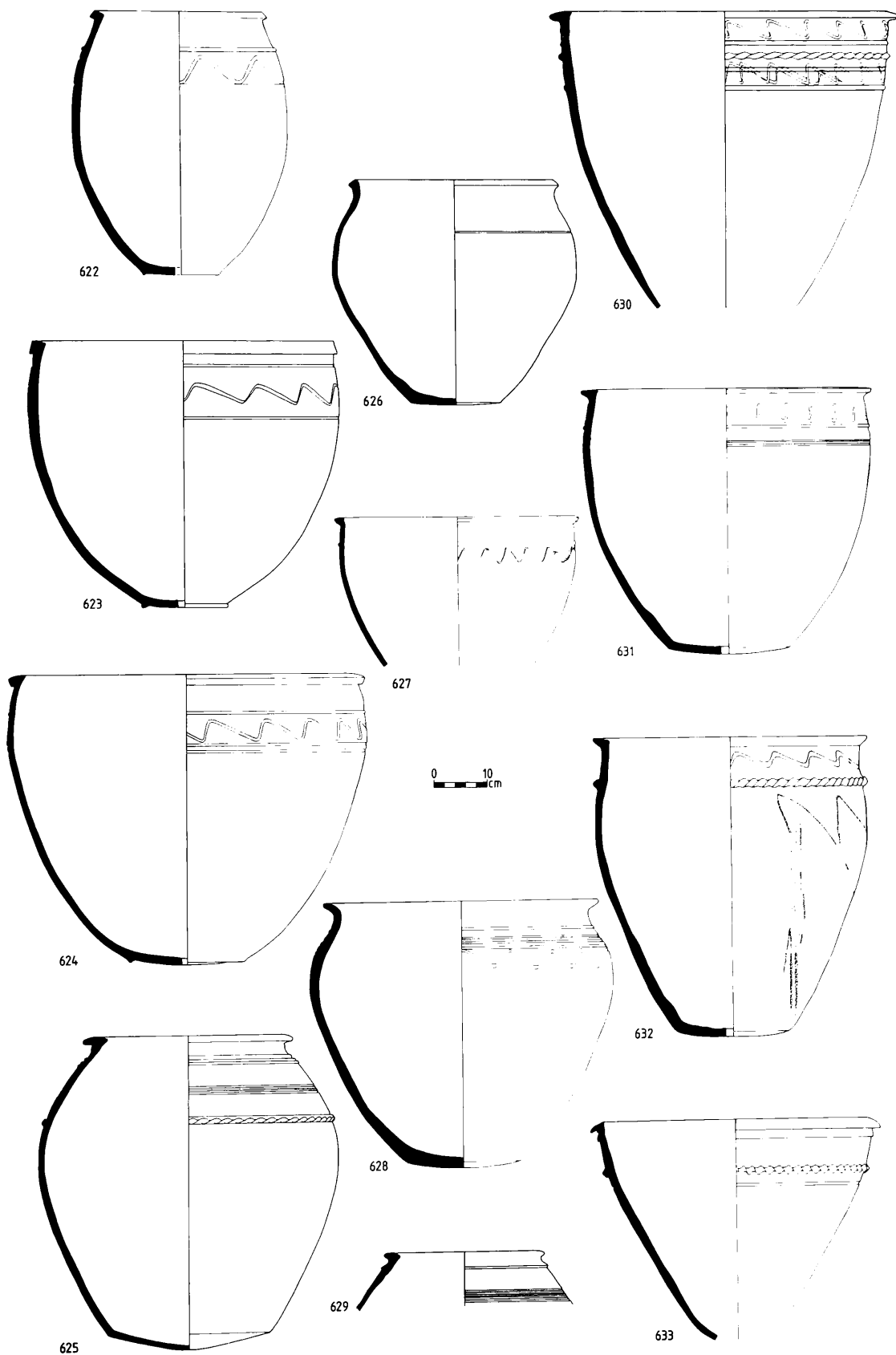
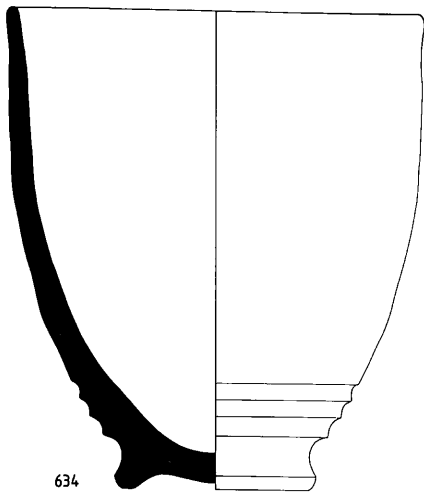

PLATE 66

DEEP BOWLS

Pot No	TR No	Batch	Level	Dimensions	Range	Ware and Remarks
634	2118	A 234	A 1	R: 24.4 cm H: 28.7 cm B: 11.0 cm	C 3	Ware: coarse light green. Temper: chaff. Paint: traces of brown paint or bitumen overall. Almost complete.
635	2117	A 284	A 1	R: 19.5 cm H: 22.5 cm B: 8.5 cm		Ware: medium coarse pink to green. Temper: grit and chaff. Surface: pink on outside and on rim. Decoration: horizontal applied cable band. Almost complete.
636		C 747	C 5b	D: 17.4 cm H: 18.0 cm B: 7.8 cm		Ware: medium coarse red to buff. Temper: grit and chaff. Slip: dark red outside and partly inside. Decoration: two horizontal applied thumb-impressed bands. Rim: missing. Almost complete.
637		A 72 A 74 A 88 A 90	A 2a	R: 30.0 cm H: 8.6 cm		Ware: coarse pink-buff. Temper: grit and chaff. Decoration: deeply-incised curves on top of rim and horizontal applied cable band outside. Rim sherd.
638		D 152	D ?	R: 11.4 cm H: 17.3 cm B: 7.3 cm		Ware: coarse buff. Temper: grit and chaff. Warped and irregular. Surface: green stains overall. Profile.
639	3113	DG 10-66	D 2	R: 16.0 cm H: 22.7 cm B: 2.4 cm		Ware: medium fine buff. Temper: grit and chaff. Contained a foetus burial. Complete.
640		A 478	A 1	R: 15.5 cm H: 9.7 cm B: 6.2 cm		Ware: medium fine yellow-buff. Temper: fine grit and little chaff. Prominent wheel-made ridges inside. Profile.
641		B	B LA	R: 13.3 cm H: 11.8 cm B: 7.0 cm		Ware: medium coarse buff to red. Temper: grit and chaff. Surface: smoothed. Profile.
642		C 379	C 5	R: 17.7 cm H: 11.5 cm B: 11.7 cm		Ware: coarse pale green. Temper: grit and chaff. Surface: bitumen coating inside. Profile.
643		A 488	A 1	R: 20.0 cm H: 7.0 cm		Ware: medium coarse buff. Temper: grit and chaff. Decoration: impressed roundels and incised wavy line outside, part of incised flower motif inside. Rim sherd.
644	190	A 61	A 1	W: 17.5 cm H: 21.0 cm		Ware: coarse green-buff. Temper: grit and chaff. Surface: smoothed outside. Decoration: two incised human figures. Two sherds of a large storage jar.
645	156	A 23	A 2	R: 17.0 cm H: 13.9 cm B: 9.0 cm		Ware: coarse orange. Temper: grit and chaff. Complete.
646		C 525	C 4	R: 17.6 cm H: 15.4 cm B: 7.8 cm		Ware: coarse dark buff. Temper: grit and chaff. Profile.
647		C 658	C 4	D: 16.5 cm H: 16.2 cm B: 8.8 cm		Ware: medium coarse yellow. Temper: grit and chaff. Rim: missing. Lower profile.



634

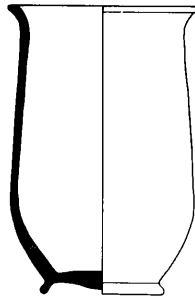

638

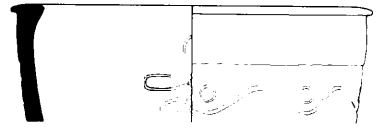

643

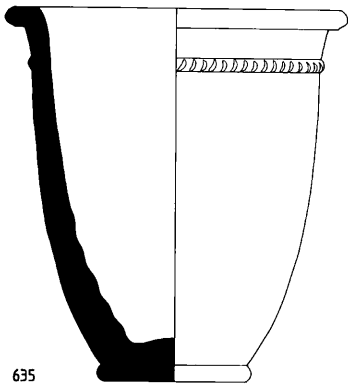

635

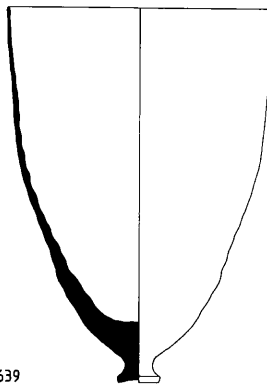

639

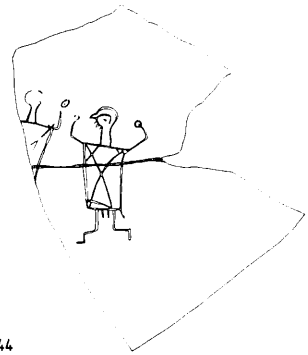

644

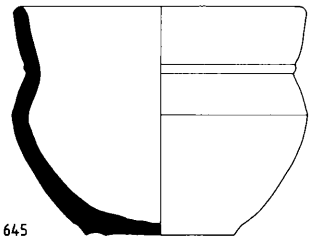

645

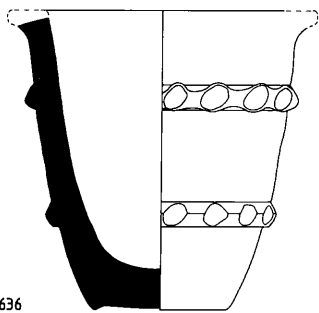

636

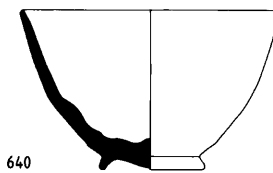

640

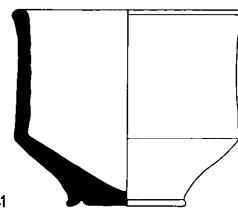

641

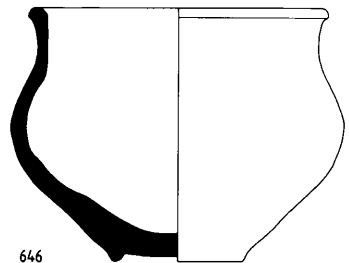

646

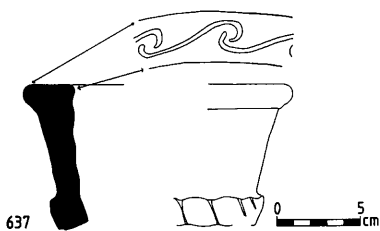

637

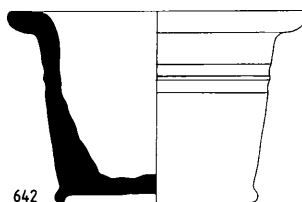

642

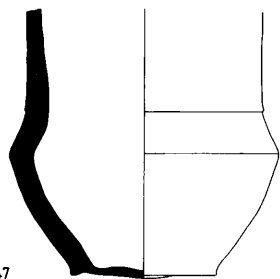

647

PLATE 67

STRAIGHT-SIDED BEAKERS

Pot No	TR No	Batch	Level	Dimensions	Range	Ware and Remarks
648		A 331	A 1	R: 6.9 cm H: 10.9 cm	A Tops C 1	Ware: medium fine green. Temper: grit and chaff. Profile.
649	2132	A 289	A 1	R: 8.5 cm H: 12.5 cm		Ware: fine light green. Temper: grit. Paint: faint traces of black. Complete.
650	2135	A 205	A LA	R: 8.0 cm H: 11.0 cm	C 2	Ware: fine light green. Temper: grit. Paint: faint traces of red-brown. Rim: slightly oval. Complete.
651	164	A 17	A 1	R: 6.8 cm H: 11.1 cm	A 1-2 C 2	Ware: medium fine green. Temper: grit. Rim: slightly oval. Complete.
652	5021	C 272	C 2	R: 7.0 cm H: 11.7 cm	A 1 C 1-4	Ware: fine green. Temper: grit. Paint: very faint traces of red-brown in horizontal band below rim out and on rim in. Surface: smoothed. Complete.
653	2105	A 33	A 1	R: 7.2 cm H: 10.5 cm	C 2-4	Ware: fine light buff. Temper: fine grit. Paint: orange, carelessly applied. Half extant.
654		A 93	A 1	R: 8.7 cm H: 10.6 cm		Ware: fine buff. Temper: grit. Paint: faded dark brown, carelessly applied. Profile.
655		A 81	A 1-2	R: 7.2 cm H: 12.4 cm	A 2a C 1-4	Ware: fine red. Temper: grit. Profile.
656		C	C 5	R: 8.8 cm H: 12.7 cm	C 3-5	Ware: fine green to yellow. Temper: grit. Rim: warped oval. Profile.
657		A 455	A 2	R: 8.5 cm H: 12.5 cm	C 1-2	Ware: fine green. Temper: grit. Profile.
658		C 398	C 5	R: 9.6 cm H: 13.2 cm	C 1-5	Ware: fine buff to green. Temper: fine grit. Profile.
659		A 81	A 1-2	R: 8.2 cm H: 13.6 cm	A 2a	Ware: fine buff. Temper: grit. Paint: very faded, probably originally red, possibly having once had superimposed white patterns. Profile.
660		A 474	A 1	R: 6.5 cm H: 5.7 cm		Ware: fine buff. Temper: fine grit. Paint: red-brown. Rim sherd.
661		C 705	C 4	R: 7.0 cm H: 11.8 cm	C 2-4	Ware: fine orange. Temper: grit. Rim: slightly warped and oval. Profile.
662		A 352	A 2a-b	R: 8.0 cm H: 12.1 cm	A 2 C 2-5	Ware: medium fine buff. Temper: grit and chaff. Profile.
663	6008	C 661	C 5	R: 10.0 cm H: 14.0 cm	C 2-5	Ware: medium fine green. Temper: grit and some chaff. Rim: very warped, almost triangular. Complete.
664	2126	A 321	Topsoil	R: 9.4 cm H: 11.2 cm	C 5	Ware: fine buff. Temper: grit. Paint: dark red outside and inside over rim. Surface: traces of light burnish outside. Base: off axis. Profile.
665		C 48	C 5	R: 8.4 cm H: 9.4 cm	A 2	Ware: fine pale pink to cream. Temper: grit. Paint: red-brown. Profile.
666		D 106	D 4	R: 9.0 cm H: 13.9 cm	C 4-5	Ware: fine green. Temper: grit. Rim: very warped and oval. Profile.
667		C 350	C 5	R: 6.3 cm H: 13.3 cm	C 5	Ware: fine pale green. Temper: grit and some chaff. Base: broken, probably pedestal. Profile.
668		C 370	C 5a	R: 8.0 cm H: 13.5 cm	A 2 C 2-5	Ware: fine pink to white. Temper: grit. Rim: missing. Surface: burnished outside with vertical marks from stem carination upwards. Profile.
669	2110	C	C 3	R: 8.1 cm H: 14.6 cm	A 2a C 2-6a	Ware: fine light green. Temper: grit and some chaff. Paint: red-brown. Almost complete.
670	6003	CG 10-71	C 1	R: 8.0 cm H: 8.5 cm		Ware: fine green. Temper: some large white grit and little chaff. Found beside left elbow of adult burial. Complete.
671		C 808	C 6	R: 8.8 cm H: 7.4 cm	A 3 C 6	Ware: very fine red, fired white in places. Temper: some large white grit. Profile.
672		A 482	A 3	R: 10.4 cm H: 8.3 cm	A 2c-3	Ware: fine pink-buff. Temper: white grit and some chaff. Surface: outside smoothed. Profile.
673		C 445	C 6	R: 7.0 cm H: 9.1 cm	A 4 C 6	Ware: fine green. Temper: grit. Profile.
674		C 801 C 805	C 6	R: 8.0 cm H: 9.0 cm	A 3 C 6	Ware: medium fine red. Temper: some large white grit and chaff. Base: coated inside and out with plaster. Profile.

STRAIGHT-SIDED BEAKERS

PLATE 67

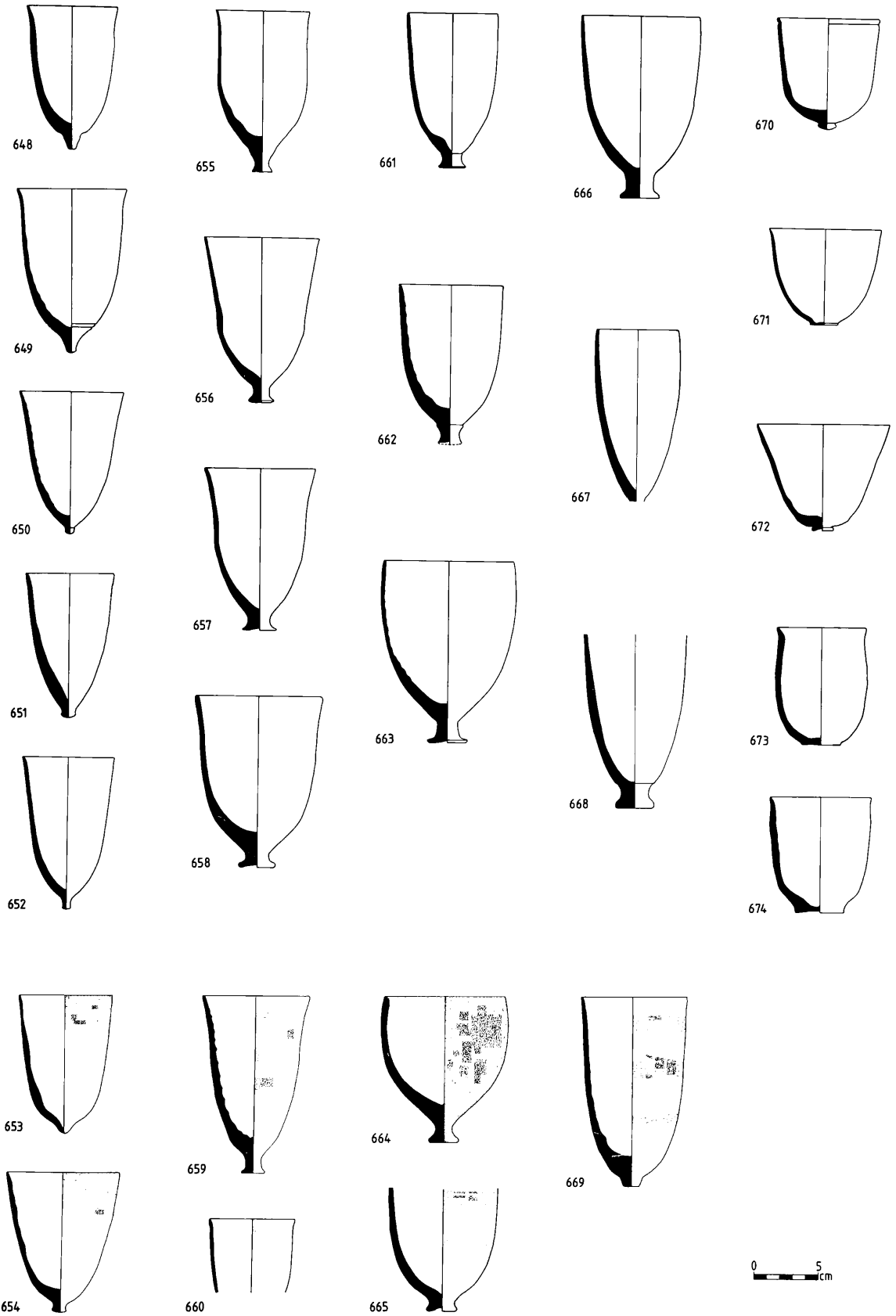

PLATE 68

NUZI WARE

Pot No	TR No	Batch	Level	Dimensions	Range	Ware and Remarks
675	2128	A 348	A 2c	R: 10.0 cm H: 8.9 cm B: 2.2 cm	C 4	Ware: fine pale buff. Temper: white grit and some chaff. Paint: brown-black bands with design of feeding birds overpainted in white. Less than half extant.
676		C 806	C 4-5	H: 7.8 cm W: 7.5 cm		Ware: fine buff. Temper: fine grit. Paint: red bands with design overpainted in white. Bodysherd.
677		C 396	C 5	H: 2.9 cm W: 2.8 cm		Ware: very fine buff. Temper: grit. Paint: black band with design of birds overpainted in white. Small bodysherd.
678		C 576	C 5	H: 2.7 cm W: 3.0 cm		Ware: fine buff. Temper: grit. Paint: deep red band with design of a bird's head overpainted in white. Small bodysherd.
679	2127	A 336 A 343	A 2a+c	R: 8.0 cm H: 11.5 cm		Ware: fine buff. Temper: white grit and chaff. Paint: red-brown bands with design overpainted in white. Base: missing. Profile.
680	3122	A 489	A 2a	R: 19.5 cm H: 7.4 cm		Ware: fine buff. Temper: grit and chaff. Paint: red-brown bands inside and over rim with design overpainted in white. Almost complete.

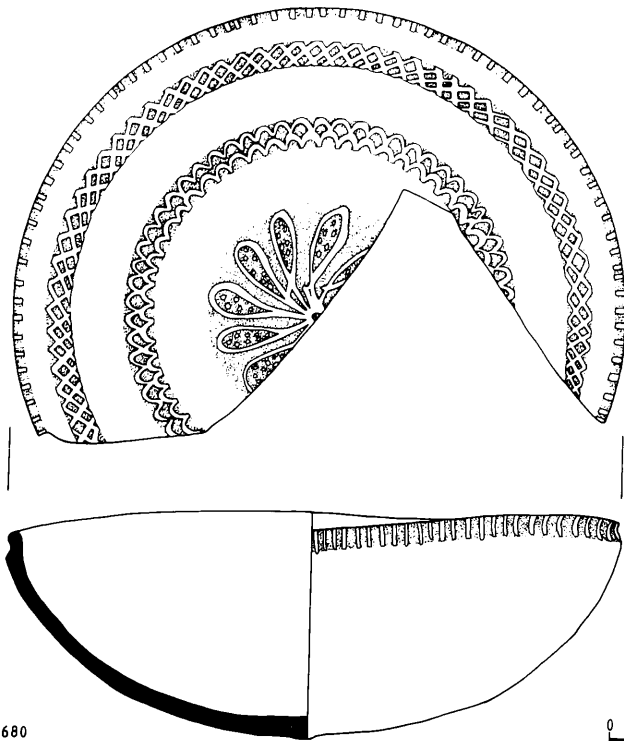
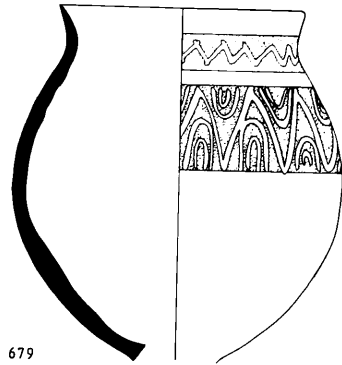
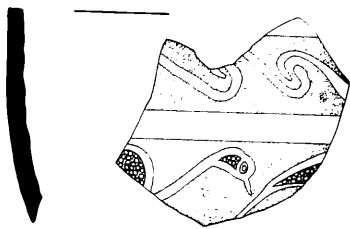
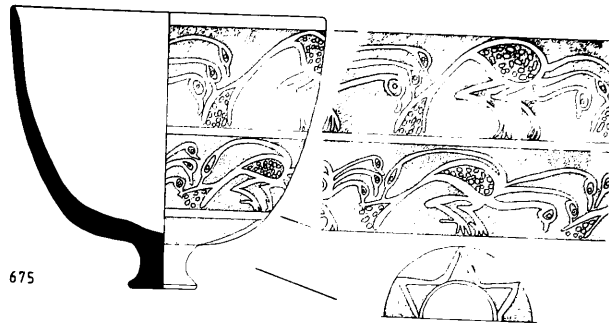

PLATE 69

NUZI WARE BEAKERS

Pot No	TR No	Batch	Level	Dimensions	Range	Ware and Remarks
681	2103	A 37	A 2c	R: 7.6 cm H: 12.4 cm B: 2.3 cm		Ware: fine green-buff. Temper: white grit. Paint: dark brown bands with design overpainted in white. Profile.
682	2141	A 342 A 352	A 2a	R: 6.3 cm H: 11.8 cm B: 2.0 cm		Ware: light green-buff. Temper: white grit. Paint: red-brown bands with design overpainted in white. Profile.
683		C	C 3	H: 5.0 cm W: 5.7 cm		Ware: fine buff. Temper: grit. Paint: red bands with design overpainted in white. Paint very worn. Rim sherd.
684		C 277	C 3	R: 9.8 cm H: 7.3 cm		Ware: fine buff. Temper: grit. Paint: black bands with design overpainted in white. Paint fugitive, pattern partly reconstructed. Rim sherd.
685			Surface	H: 3.4 cm W: 3.3 cm		Ware: fine buff. Temper: much grit. Paint: black band with design overpainted in white. Bodysherd.
686		A 389	Mixed	H: 2.7 cm W: 3.0 cm		Ware: fine buff. Temper: grit. Paint: black band with design overpainted in white. Bodysherd.
687		A 20	A 2a-b	R: 7.1 cm H: 13.7 cm B: 2.0 cm		Ware: very fine buff. Temper: fine grit. Paint: dark brown bands with design overpainted in white. Pattern reconstructed. Profile.
688		A 286	A 1	R: 6.7 cm H: 3.6 cm		Ware: medium fine buff. Temper: grit. Paint: deep red with design overpainted in white. Rim sherd.
689		C 710	C 5	R: 7.0 cm H: 5.2 cm		Ware: fine buff. Temper: grit. Paint: brown band with design overpainted in white. Rim sherd.
690			Surface	H: 4.8 cm W: 3.5 cm		Ware: fine buff. Temper: grit. Paint: black to red bands with design overpainted in white. Bodysherd.
691		A 277	A 1	H: 3.8 cm W: 3.6 cm		Ware: medium fine buff. Temper: grit. Paint: black band with design overpainted in white. Bodysherd.
692		A 345	A 2c	R: 7.0 cm H: 10.6 cm	C 1 A 2c	Ware: very fine buff. Temper: grit. Paint: black bands with design overpainted in white. Paint very worn. Rim sherd.
693		A 346	A 2c	R: 9.5 cm H: 9.5 cm		Ware: fine buff. Temper: white grit. Paint: dark brown bands with design overpainted in white. Rim sherd.
694	3121	A 346	A 2c	R: 8.0 cm H: 14.1 cm		Ware: fine buff. Temper: grit. Paint: black bands with design overpainted in white. Rim sherd.
695		C 950	C 6a	H: 6.8 cm W: 4.9 cm		Ware: fine buff. Temper: grit. Paint: black bands fired to red in places with design overpainted in white. Bodysherd.
696		C 747	C 5b	H: 5.0 cm W: 3.8 cm		Ware: fine green-buff. Temper: grit. Paint: dark brown bands with design overpainted in white. Bodysherd.
697		C 747	C 5b	H: 3.3 cm W: 2.3 cm		Ware: fine buff. Temper: grit and fine chaff. Paint: dark brown with design overpainted in white. Bodysherd.
698		C 916	C 5	D: 7.0 cm H: 9.6 cm B: 3.0 cm	A 3	Ware: fine buff. Temper: grit. Paint: red-brown bands with design overpainted in white. Base: complete but rim missing. Base sherd.

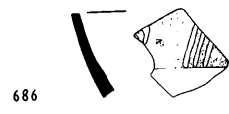
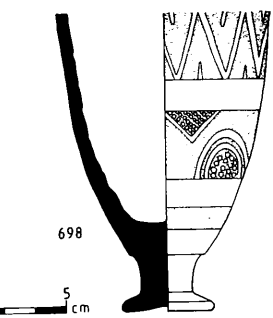
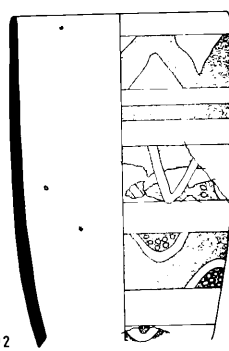
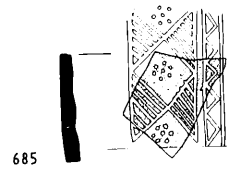
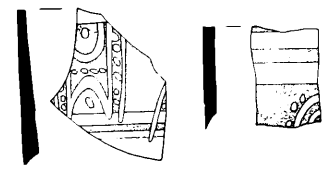
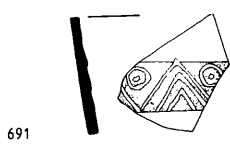
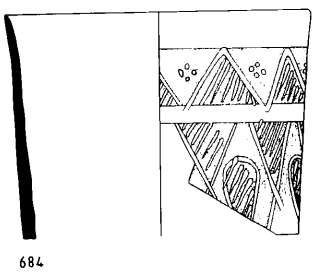
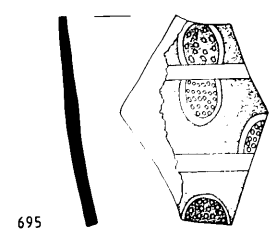
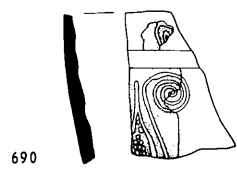
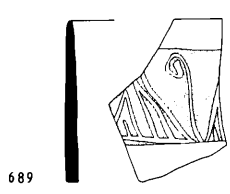
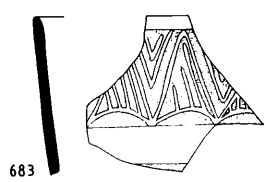
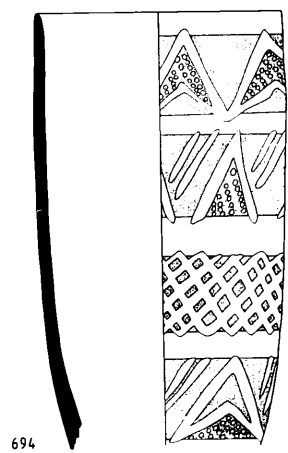
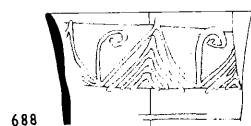
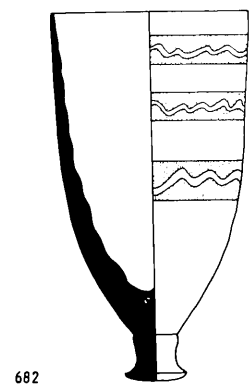
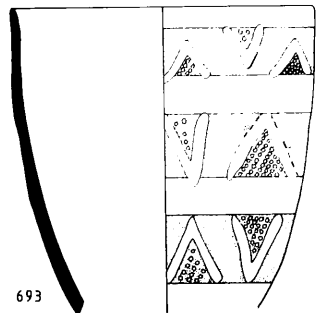
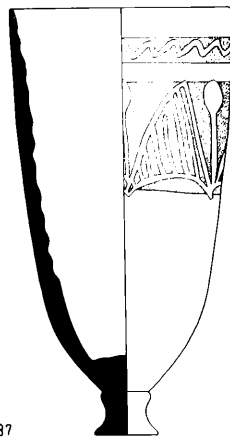
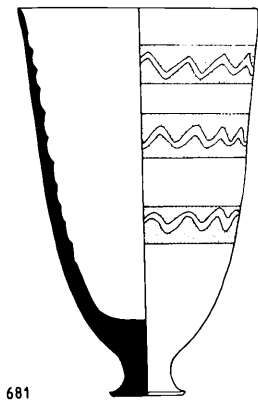
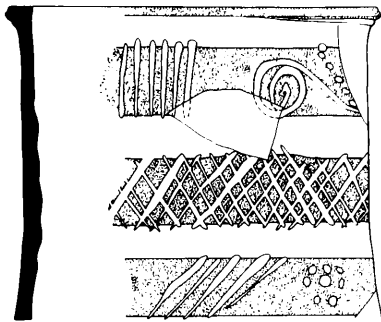

PLATE 70

NUZI WARE BEAKERS

Pot No	TR No	Batch	Level	Dimensions	Range	Ware and Remarks
699		C 372	C 5b	R: 11.8 cm H: 10.0 cm		Ware: fine buff. Temper: grit and chaff. Paint: black bands with design overpainted in white. Rim sherd.
700		D 115	D 4	H: 4.7 cm W: 9.0 cm		Ware: medium fine light buff. Temper: grit. Paint: red band with design overpainted in white. Pattern expanded in drawing for clarity. Bodysherd.
701		A	Surface	H: 4.5 cm W: 6.0 cm		Ware: medium coarse pink-buff. Temper: chaff. Paint: thick red band with design overpainted in white. Bodysherd.
702		A 336	A 2c	H: 2.0 cm W: 2.1 cm		Ware: very fine red. Temper: grit. Paint: red band with design overpainted in white. Bodysherd.
703		A 78	A 1	D: 6.1 cm H: 3.2 cm B: 1.5 cm		Ware: very fine buff. Temper: fine grit. Paint: black band with design overpainted in white. Base sherd.
704		C 537	C 5	D: 8.0 cm H: 5.5 cm		Ware: fine buff. Temper: grit. Paint: black band with design overpainted in white. Bodysherd near base.
705		A 232	A 1	R: 2.1 cm W: 3.4 cm		Ware: fine green. Temper: grit. Paint: red bands with design overpainted in white. Rim sherd.
706		C 504	Unstratified	R: 6.0 cm H: 1.6 cm		Ware: fine buff. Temper: grit. Paint: red band with design overpainted in white. Rim sherd.
707		A 437	A 2a-b	R: 16.0 cm H: 6.0 cm		Ware: fine light buff. Temper: grit. Paint: red bands with design overpainted in white. Rim sherd.
708			Surface	H: 4.8 cm W: 5.6 cm		Ware: fine buff. Temper: grit. Paint: red bands with design overpainted in white. Rim sherd.
709		C 266	C 2	H: 2.7 cm W: 1.7 cm	A 2a C 2	Ware: fine buff. Temper: grit. Paint: black band with design overpainted in white. Rim sherd.
710			Surface	H: 4.5 cm W: 2.9 cm		Ware: medium fine green. Temper: grit. Paint: red band with design overpainted in white. Bodysherd.
711		C 283	C 4	H: 5.0 cm W: 4.0 cm		Ware: fine buff. Temper: grit. Paint: black band with design overpainted in white. Bodysherd.
712		A 303	A 1	H: 3.4 cm W: 3.3 cm	A 2c	Ware: fine buff. Temper: grit. Paint: red band with design overpainted in white. Bodysherd.
713		C 747	C 5b	D: 8.2 cm H: 5.4 cm		Ware: fine buff. Temper: grit. Paint: very faded red-brown bands with design overpainted in white. Bodysherd near base.
714		C 125	C 1	H: 4.0 cm W: 3.2 cm		Ware: fine buff. Temper: grit. Paint: red band with design overpainted in white. Rim sherd.
715			Surface	H: 4.0 cm W: 3.2 cm		Ware: fine green. Temper: grit. Paint: black to red bands with design overpainted in white. Bodysherd.
716		C 683	C 4-5	H: 5.0 cm W: 4.0 cm	C 2	Ware: fine buff. Temper: grit. Paint: bright red band with design overpainted in white. Bodysherd.
717		C 605	C 4-5	D: 7.2 cm H: 9.0 cm B: 1.7 cm		Ware: fine red. Temper: white grit. Paint: red band with design overpainted in white. Base sherd.



699

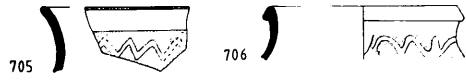

705

706

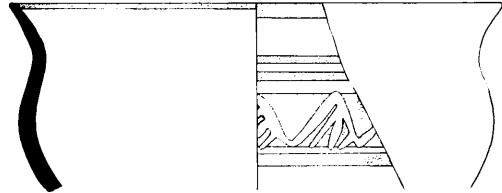

707



700

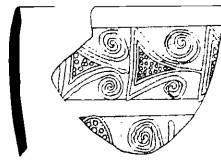

708



709



714

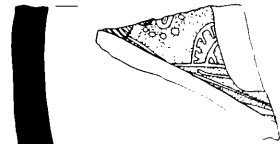

701

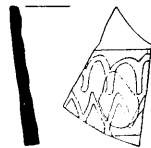

710



715



702

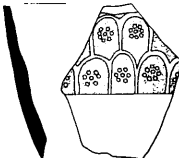

711

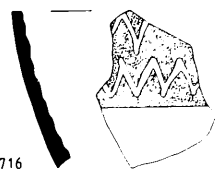

716



703

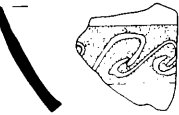

712

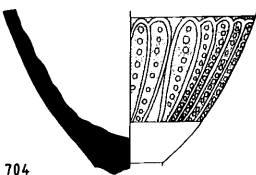

704

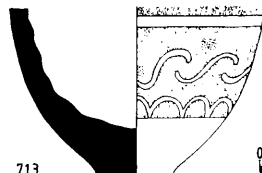

713

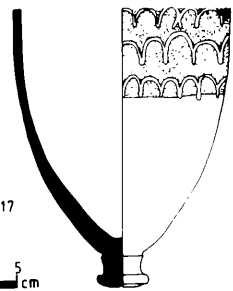

717



PLATE 71

FINE NUZI WARE BEAKERS

Pot No	TR No	Batch	Level	Dimensions	Range	Ware and Remarks
718		A 72	A 2a	H: 4.4 cm W: 3.6 cm		Ware: extremely fine buff. Temper: none. Paint: deep black bands with design overpainted in white. Rim sherd. Plate 19f
719		A 72	A 2a	H: 2.5 cm W: 1.9 cm H: 5.0 cm W: 2.9 cm		Ware: extremely fine buff. Temper: none. Paint: red to black band with design overpainted in white. Two bodysherds from the same vessel. Plate 19f
720		A 72	A 2a	H: 3.7 cm W: 2.1 cm		Ware: extremely fine green. Temper: none. Paint: black band with design overpainted in white. Paint very worn and pattern indistinct. Bodysherd. Plate 19f
721		C 943	C 4-5	H: 1.8 cm W: 2.3 cm		Ware: extremely fine light buff. Temper: fine grit. Paint: black band with design overpainted in white. Bodysherd.
722		A 69	A 2b	H: 1.5 cm W: 1.4 cm		Ware: extremely fine buff. Temper: none. Paint: black band with design overpainted in white. Bodysherd.
723		A 69	A 2b	H: 1.7 cm W: 1.5 cm		Ware: extremely fine buff. Temper: none. Paint: black band with design overpainted in white. Bodysherd.
724		C	C 2	H: 3.3 cm W: 7.8 cm		Ware: very fine buff. Temper: none. Paint: red band with design overpainted in white. Base: broken. Base sherd. Plate 23c

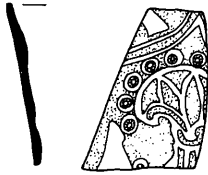
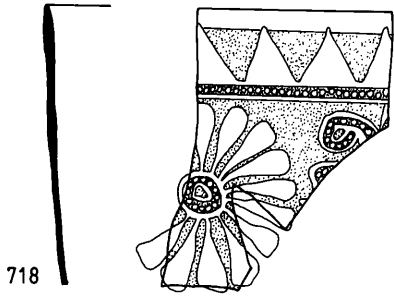

719

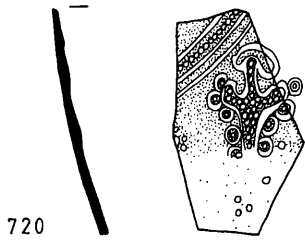

721

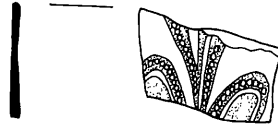

723

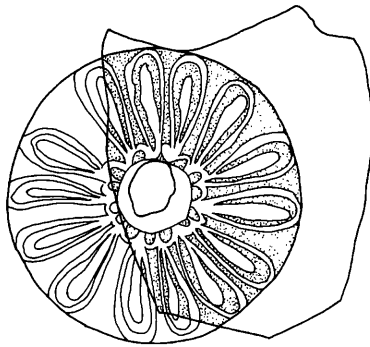
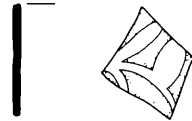

724



PLATE 72

UNDECORATED SHOULDERED BEAKERS

Pot No	TR No	Batch	Level	Dimensions	Range	Ware and Remarks
725		C 117	C 1	R: 8.1 cm H: 9.6 cm	C 1	Ware: fine green. Temper: grit. Late Assyrian "Palace ware". Surface: smoothed, with a thin coating of bitumen inside and drips outside. Profile.
726		B	B LA	R: 8.3 cm H: 8.3 cm		Ware: medium fine light buff. Temper: grit and chaff. Surface: coating of bitumen inside and outside round rim. Profile.
727	3105	D 139	D 3	R: 7.7 cm H: 10.3 cm		Ware: fine buff. Temper: grit and chaff. Contained seeds. Complete.
728		A 326	A 2c	R: 9.3 cm H: 10.8 cm	C 1	Ware: medium fine pink-buff with dark core. Temper: white grit. Surface: smoothed. Profile.
729	4103	A	A 2c	R: 7.8 cm H: 9.3 cm		Ware: fine buff. Temper: grit. Almost complete. Plate 20e
730		A	A 3	R: 8.0 cm H: 10.0 cm	A 3	Ware: fine green. Temper: grit. Profile.
731		A 310	A 2	R: 5.2 cm H: 10.3 cm		Ware: fine buff. Temper: grit. Profile.
732		D 69	D 4	R: 6.2 cm H: 9.0 cm		Ware: medium fine green-buff. Temper: grit. Profile.
733		A 310	A 2	R: 5.2 cm H: 8.9 cm		Ware: medium fine buff. Temper: grit and chaff. Profile.
734	2113	C	C 1	R: 5.4 cm H: 9.9 cm		Ware: medium fine light green. Temper: grit and chaff. Complete.
735	3110	A 461	A 1	R: 4.1 cm H: 10.7 cm		Ware: medium fine green. Temper: grit. Complete.
736		C 75	C 4	H: 9.5 cm B: 1.4 cm	C 5	Ware: medium fine buff. Temper: white grit. Rim: missing. Profile.
737	2139	A 307	A 2a-b	R: 8.1 cm H: 9.0 cm		Ware: medium fine buff. Temper: grit. Found inside Pot 976. Complete.
738		C 907	C 5b	H: 5.6 cm B: 2.8 cm		Ware: medium fine green. Temper: white grit. Rim: missing. Lower profile.
739		C 649	C 4	H: 7.2 cm B: 1.6 cm		Ware: medium fine red. Temper: grit and chaff. Rim: missing. Lower profile.
740	6007	C 652	C 5	R: 4.8 cm H: 4.8 cm B: 2.1 cm		Ware: medium fine yellow. Temper: grit and chaff. Beaker has had rim and base removed in antiquity, the breaks then smoothed. Two holes pierced on opposite sides of present rim. Complete.
741	6004	C 803 CG 11-71	C 5	R: 5.4 cm H: 9.1 cm		Ware: medium fine buff. Temper: grit and chaff. Found in child burial in rimless large jar. Complete.
742		C	C 3	R: 5.7 cm H: 9.2 cm	A 2c	Ware: medium fine buff. Temper: grit. Profile.
743		C 706	C 4	R: 5.9 cm H: 8.9 cm		Ware: medium fine yellow-buff. Temper: grit. Profile.
744		C 652	C 5	H: 7.1 cm B: 2.1 cm		Ware: medium fine green. Temper: grit and chaff. Rim: missing. Lower profile.
745		C 544	C 6a	H: 9.2 cm B: 1.6 cm		Ware: medium fine buff. Temper: grit. Rim: missing. Profile.
746	5046	C 404	C 6a	R: 6.3 cm H: 8.7 cm		Ware: fine buff. Temper: fine grit and some chaff. Surface: smoothed. Complete.
747		A 345 A 346	A 2c	R: 6.8 cm H: 9.3 cm	A 3	Ware: fine buff. Temper: fine grit. Surface: smoothed. Profile.
748		A 346	A 2c	R: 7.8 cm H: 9.3 cm	A 2-3	Ware: fine light buff. Temper: fine grit. Profile.
749		C 48	C 5	R: 9.7 cm H: 13.6 cm	A 3	Ware: medium fine buff. Temper: grit and little chaff. Profile.
750	159	A	A 2	R: 7.5 cm H: 13.6 cm	A 3 C 5	Ware: fine buff. Temper: grit. Complete.
751	5052	CG 17-68	C 5	R: 7.7 cm H: 14.6 cm		Ware: fine red-buff. Temper: fine grit. Found beside head in burial with Pot 74. Almost complete.
752		C 568	C 5	H: 10.2 cm B: 3.0 cm		Ware: fine buff fired red to cream in places. Temper: large white grit and some chaff. Surface: highly burnished outside with horizontal marks fading away towards base, which is not burnished. Rim: missing. Lower profile.

UNDECORATED SHOULDERED BEAKERS

PLATE 72

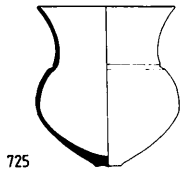

725

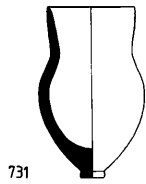

731

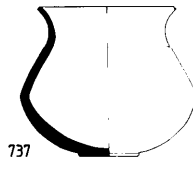

737

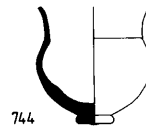

744

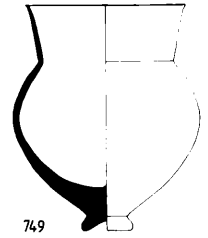

749

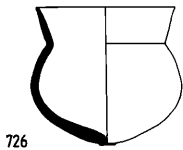

726

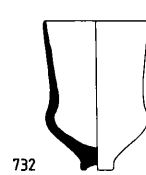

732

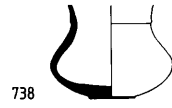

738

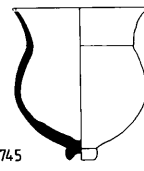

745

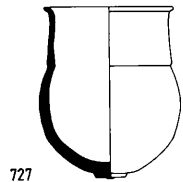

727

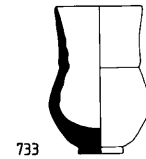

733

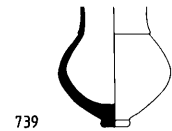

739

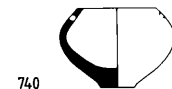

740

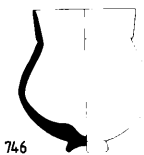

746

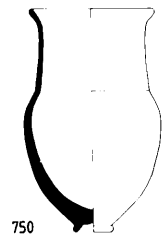

750

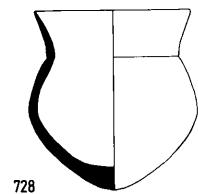

728

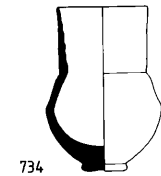

734

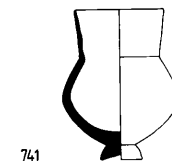

741

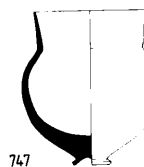

747

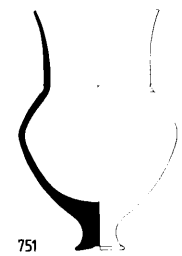

751

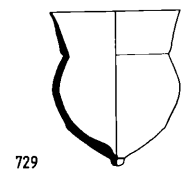

729

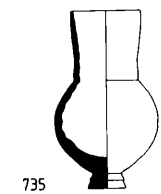

735

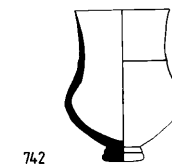

742

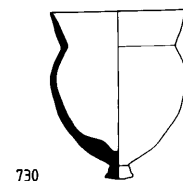

730

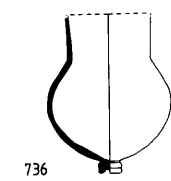

736

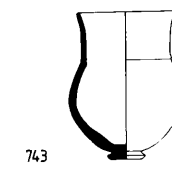

743

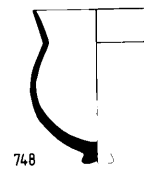

748

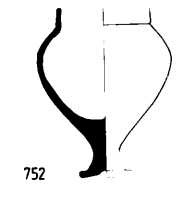

752

PLATE 73 UNDECORATED SHOULDERED BEAKERS - OLD BABYLONIAN

Pot No	TR No	Batch	Level	Dimensions	Range	Ware and Remarks
753		A 556	A 3	R: 14.5 cm H: 10.9 cm		Ware: medium fine buff. Temper: grit and chaff. Surface: thick coating of bitumen inside over lower part of beaker. Profile.
754		C	C 6	R: 11.5 cm H: 10.0 cm	A 3 C 5	Ware: medium fine buff. Temper: grit. Profile.
755	4109	A 581	A 3	R: 10.5 cm H: 12.8 cm	A 3 C 5	Ware: medium fine buff. Temper: grit and chaff. Surface: very burnt. Rim: oval. Found inside Pots 614 and 615. Complete.
756		C 403	C 6A	R: 8.8 cm H: 8.2 cm		Ware: medium fine buff fired red in places. Temper: Large white grit. Rim: warped oval. Profile.
757		A 553	A 3	R: 7.2 cm H: 10.7 cm	A 3 C 5	Ware: fine orange-buff. Temper: white grit. Profile.
758		C 445	C 6	H: 9.5 cm B: 2.4 cm		Ware: very fine buff with grey core. Temper: grit. Rim: missing. Lower profile.
759		C 78	C 6	H: 9.2 cm B: 1.9 cm	C 6	Ware: very fine dark buff. Temper: grit. Rim: missing. Lower profile.
760		C 52	C 6	R: 7.2 cm H: 11.0 cm	A 3 C 6	Ware: very fine buff. Temper: grit. Base: broken. Profile.
761		C 78	C 6	R: 6.8 cm H: 10.5 cm	C 5-6	Ware: very fine brown. Temper: grit. Profile.
762		C 808	C 6	R: 7.3 cm H: 9.6 cm	C 5	Ware: very fine green. Temper: grit. Profile.
763		C 808	C 6	R: 7.1 cm H: 8.5 cm	C 6	Ware: very fine buff. Temper: grit. Base: missing. Upper profile.
764		A 634	A 4	R: 7.0 cm H: 12.0 cm	C 5	Ware: very fine light orange. Temper: grit. Profile.
765		C 395 C 444	C 6	H: 11.1 cm B: 1.9 cm		Ware: extremely fine green. Temper: none. Rim: missing. Lower profile.
766	5002	A 604	A 4	R: 8.1 cm H: 8.7 cm		Ware: fine buff. Temper: grit. Complete.
767		A 419	A 3	R: 7.8 cm H: 8.5 cm	A 3 C 6	Ware: fine pale buff. Temper: grit. Surface: coating of bitumen on one side. Profile.
768		C 808	C 6	R: 8.2 cm H: 8.1 cm	C 4-6	Ware: very fine buff to white. Temper: grit. Profile.
769	4123	A	Unstratified	R: 7.7 cm H: 8.8 cm		Ware: fine light buff fired red in places. Temper: grit. Base: cracked in firing, has tiny hole. Complete.
770		C 445	C 6	R: 8.4 cm H: 9.7 cm	A 3 C 6	Ware: very fine buff. Temper: grit. Profile.
771		C 445	C 6	H: 6.6 cm B: 1.8 cm		Ware: very fine buff. Temper: grit. Rim: missing. Lower profile.
772		A 728	A 3	H: 7.3 cm B: 1.6 cm		Ware: fine light buff. Temper: grit. Rim: missing. Lower profile.
773	5016	A 599	A 3	R: 7.9 cm H: 12.1 cm	A 3 C 5	Ware: fine black with grey core. Temper: fine white grit. Surface: highly burnished. Almost complete.
774		A 600	A 3	R: 6.7 cm H: 11.0 cm	C 5-6	Ware: fine pale buff. Temper: grit. Base: missing. Upper profile.
775		A 735	A 3	R: 8.8 cm H: 14.0 cm	C 5	Ware: fine pink-buff. Temper: grit. Profile.
776		A 612	Unstratified	R: 8.5 cm H: 15.8 cm		Ware: medium fine brick red. Temper: white grit. Rim: warped oval. Profile.
777		A 599	A 3	R: 8.8 cm H: 14.0 cm	C 5	Ware: fine grey. Temper: little grit. Surface: well smoothed. Profile.

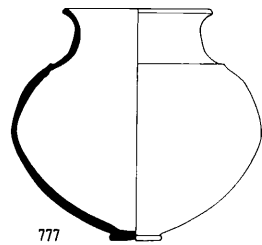
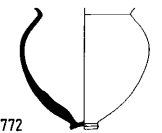
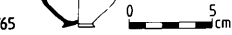
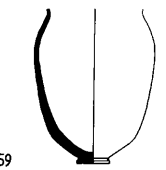
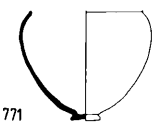
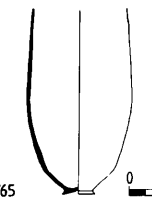
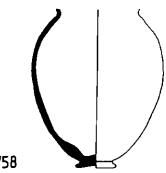
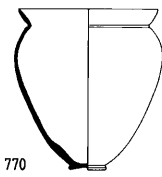
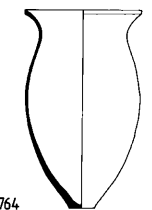
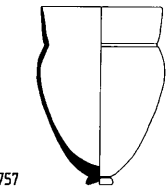
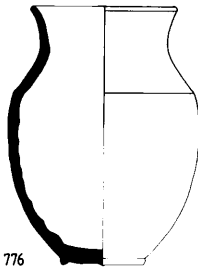
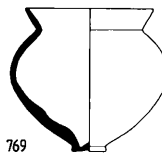
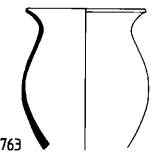
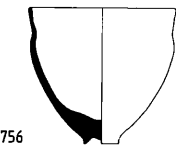
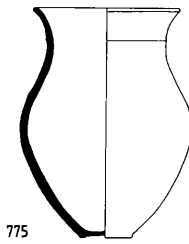
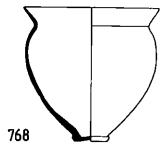
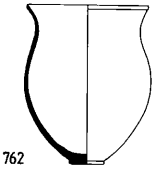
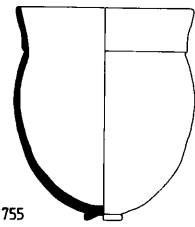
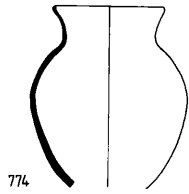
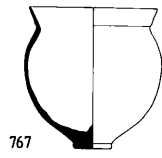
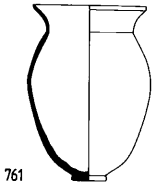
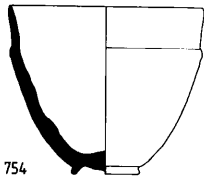
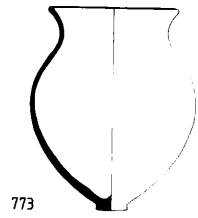
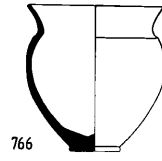
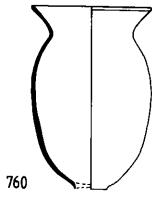
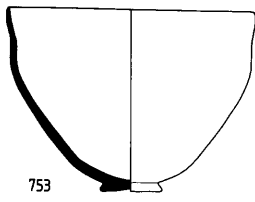
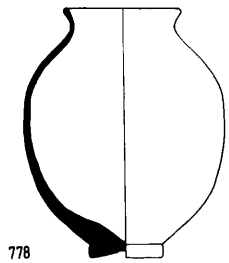

PLATE 74

PAINTED SHOULDERED BEAKERS – MA TO OLD BABYLONIAN

Pot No	TR No	Batch	Level	Dimensions	Range	Ware and Remarks
778		A 455	A 2	R: 6.6 cm H: 14.9 cm	A 2a	Ware: medium fine pale buff. Temper: grit and chaff. Paint: faded red. Profile.
779		A 565	A 3	R: 9.0 cm H: 11.8 cm	A 3	Ware: medium fine pink-buff. Temper: grit and chaff. Paint: red-brown. Profile.
780		C 531	C 3	R: 6.2 cm H: 19.1 cm	C 5	Ware: medium fine green. Temper: grit and chaff. Paint: very worn.brown. Profile.
781	4100	C	C 3	R: 5.6 cm H: 15.1 cm		Ware: medium fine green-buff. Temper: large white grit. Paint: brown. Surface: slightly burnished. Complete. Plate 20c
782		C 950	C 6a	R: 8.4 cm H: 11.7 cm	A 3 C 5	Ware: medium fine green. Temper: grit and chaff. Paint: red with splashes inside. Profile.
783		C 578	C 5	R: 11.0 cm H: 15.8 cm	A 2-3 C 5	Ware: medium fine green. Temper: grit and some chaff. Paint: black. Warped and uneven. Base: missing. Lower profile.
784	6025	C 686	C 6a	R: 7.8 cm H: 14.0 cm	C 5	Ware: medium fine buff. Temper: grit. Paint: red. Pot F <i>Figure 11</i> . Almost complete.
785	6026	C 686	C 6a	R: 7.7 cm H: 13.5 cm	A 3 C 5	Ware: fine buff. Temper: grit. Paint: red. Pot N <i>Figure 11</i> . Complete.
786		C	C 5	R: 6.0 cm H: 11.0 cm	A 1 C 5-6	Ware: medium fine buff. Temper: grit. Paint: dark red. Rim: missing. Profile.
787		C 697	C 6	R: 10.0 cm H: 10.6 cm		Ware: medium fine red. Temper: grit and chaff. Paint: thick red applied irregularly. Warped and uneven. Profile.
788		C 581	C 6a	R: 10.0 cm H: 10.0 cm	A 3	Ware: edium coarse pink. Temper: grit and chaff. Paint: red applied unevenly. Profile.
789	5047	C 410	C 6a	R: 8.6 cm H: 9.6 cm		Ware: medium fine red. Temper: fine white grit. Paint: red. Rim: warped. Almost complete.
790		C 369	C 6a	R: 17.9 cm H: 10.9 cm	A 1-3 C 5	Ware: medium coarse brown to red. Temper: chaff. Paint: red with splashes inside. Base: missing. Rim sherd.
791		A 577	A 3	R: 16.0 cm H: 7.0 cm	C 5	Ware: medium fine buff. Temper: grit. Paint: orange. Base: missing. Rim sherd.
792		C 950	C 6a	R: 14.0 cm H: 10.4 cm	C 5-6	Ware: medium coarse green. Temper: grit and chaff. Paint: black applied unevenly. Profile.
793		C 77	C 6a	R: 11.3 cm H: 11.6 cm	A 3 C 4	Ware: medium fine orange. Temper: grit. Paint: red with splashes inside. Profile.
794		A 599	A 3	R: 11.0 cm H: 9.5 cm	A 3	Ware: medium fine green. Temper: grit. Paint: brown with splashes inside. Profile.
795	2104	C	C 5	R: 9.0 cm H: 8.2 cm	C 5	Ware: medium fine buff. Temper: white grit and chaff. Paint: dark brown with splashes inside, applied unevenly. Profile.
796		A 406	A 3	R: 10.6 cm H: 6.3 cm	A 3 C 5	Ware: medium fine buff. Temper: few grits. Paint: orange with splashes inside. Base: missing. Rim sherd.
797		C 29	C 6a	R: 12.2 cm H: 14.1 cm	A 3 C 5-6	Ware: medium fine buff. Temper: grit and chaff. Paint: red with splashes inside. Profile.
798		A 629	A 3	R: 12.0 cm H: 7.5 cm	A 3 C 5-6	Ware: medium fine cream. Temper: grit. Paint: black with splashes inside. Base: missing. Rim sherd.
799		C 43	C 5b	R: 12.0 cm H: 12.1 cm	A 3 C 5-6	Ware: medium fine buff. Temper: grit and chaff. Paint: dark red with splashes inside. Profile.
800		A 583	A 3	R: 11.0 cm H: 12.1 cm	A 3 C 5	Ware: medium fine buff. Temper: grit and chaff. Paint: very faded dark, possible extending from above carination to rim. Profile.
801	6027	C 686	C 6a	R: 9.2 cm H: 11.3 cm	A 3 C 5-6a	Ware: medium fine buff. Temper: grit and little chaff. Paint: red with splashes inside. Almost complete.
802		A 590	A 3	R: 7.2 cm H: 7.8 cm	A 3 C 5	Ware: medium fine buff. Temper: grit and chaff. Paint: red. Profile.



778

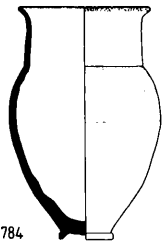

784

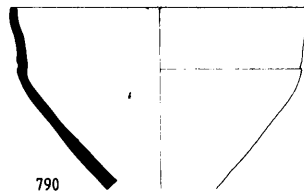

790

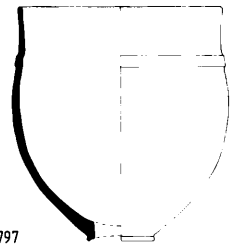

797

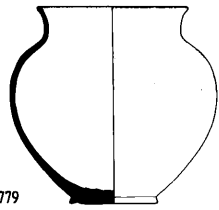

779

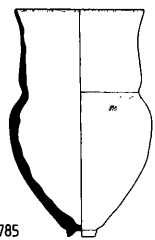

785

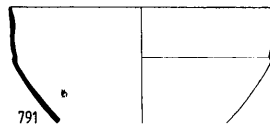

791



798

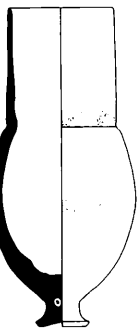

780

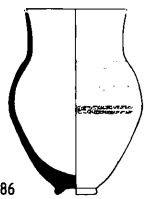

786

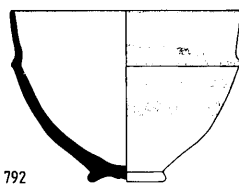

792

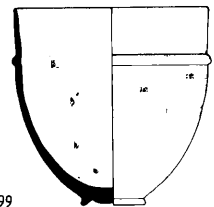

799



781

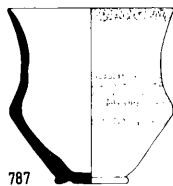

787

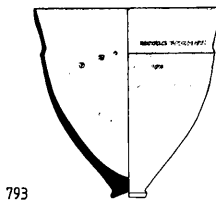

793

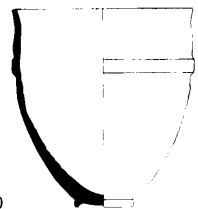

800



794

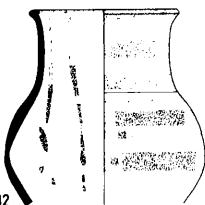

782

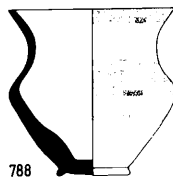

788

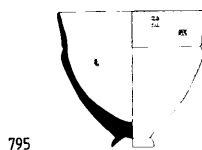

795



801

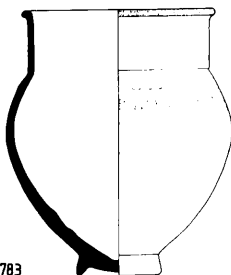

783

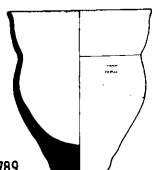

789

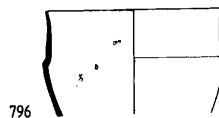

796



802

PLATE 75 PAINTED SHOULDERED BEAKERS – LATE OLD BABYLONIAN

Pot No	TR No	Batch	Level	Dimensions	Range	Ware and Remarks
803		C 686	C 6a	R: 7.2 cm H: 9.5 cm B: 2.0 cm	A 3 C 5	Ware: fine green. Temper: grit. Paint: brown to black, very flaked and worn. Pot Q <i>Figure 11</i> . Profile.
804	4102	A 553	A 3	R: 7.0 cm H: 9.5 cm B: 1.0 cm	A 3 C 5	Ware: fine pink to buff. Temper: grit and little chaff. Paint: red. Almost complete. Plate 20a
805		A 599	A 3	R: 7.0 cm H: 9.0 cm B: 2.0 cm	A 3	Ware: fine cream. Temper: grit. Paint: dark brown. Profile.
806	3111	A 446	A 2c-3	R: 7.0 cm H: 9.5 cm B: 2.1 cm	A 2-3 C 5	Ware: fine green-buff. Temper: grit. Paint: brown. Complete.
807	3141	A 465	A 3	R: 7.8 cm H: 9.5 cm B: 2.0 cm	A 3	Ware: fine cream. Temper: grit. Paint: red-brown with splashes inside. Complete.
808		C 950	C 6a	R: 8.0 cm H: 9.6 cm B: 2.2 cm	C 5-6	Ware: fine buff. Temper: grit. Paint: dark red. Profile.
809		C 948	C 6a	R: 7.3 cm H: 9.3 cm B: 2.3 cm	A 3 C 5-6	Ware: fine buff. Temper: grit. Paint: red applied unevenly. Profile.
810	6029	C 686	C 6a	R: 7.4 cm H: 8.8 cm B: 2.2 cm	A 3	Ware: fine buff. Temper: grit. Paint: black. Rim: warped. Pot X <i>Figure 11</i> . Found in Pot 1021 with Pot 811. Almost complete.
811	6028	C 686	C 6a	R: 7.8 cm H: 9.1 cm B: 1.9 cm	A 3	Ware: fine buff. Temper: grit. Paint: red. Rim: warped. Pot W <i>Figure 11</i> . Found in Pot 1021 with Pot 810. Complete.
812	6033	C 686	C 6a	R: 6.7 cm H: 7.6 cm B: 1.6 cm	A 3 C 5-6	Ware: fine green. Temper: large white grit. Paint: brown, very faded and flaked. Pot R <i>Figure 11</i> . Complete.
813		C 674	C 6a	R: 7.1 cm H: 8.3 cm B: 2.6 cm		Ware: fine pink. Temper: grit. Paint: brown. Profile.
814	6030	C 686	C 6a	R: 6.9 cm H: 9.7 cm B: 1.8 cm	A 3	Ware: fine green fired red in places. Temper: some large white grit. Paint: brown, faded. Pot AC <i>Figure 11</i> . Found in Pot 1025. Complete.
815		C 696	C 6a	R: 7.2 cm H: 9.3 cm B: 1.8 cm	A 3 C 5-6	Ware: fine green-buff. Temper: large white grit. Paint: black. Profile.
816	6032	C 686	C 6a	R: 6.5 cm H: 8.6 cm B: 1.8 cm	C 6	Ware: fine green. Temper: large white grit. Paint: red-brown, faded. Pot AB <i>Figure 11</i> . Found in Pot 1025. Complete.
817	6031	C 686	C 6a	R: 7.0 cm H: 8.6 cm B: 1.6 cm		Ware: fine green. Temper: large white grit. Paint: red-brown. Base: slightly cracked inside. Pot AA <i>Figure 11</i> . Found in Pot 1025. Complete.

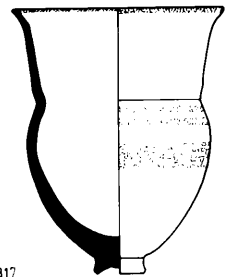
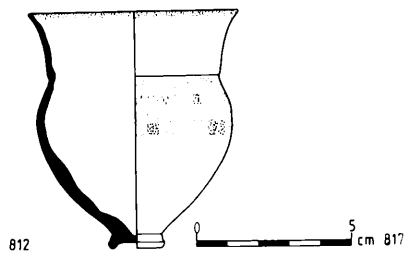
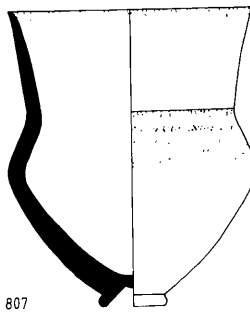
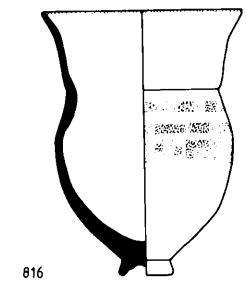
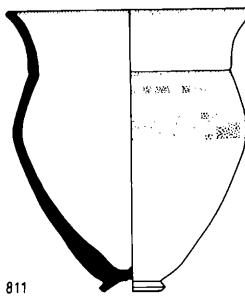
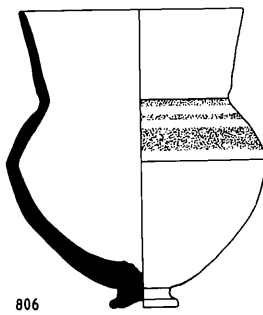
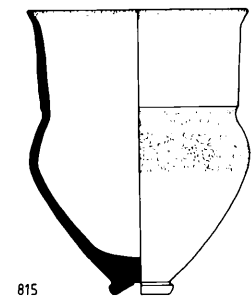
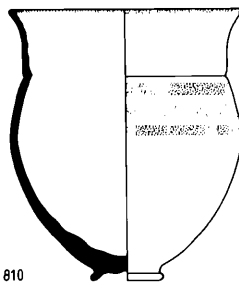
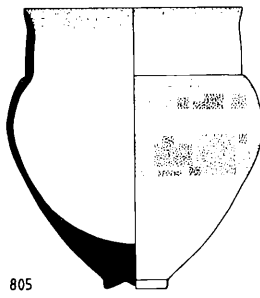
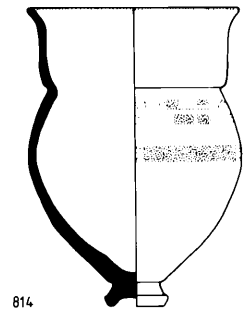
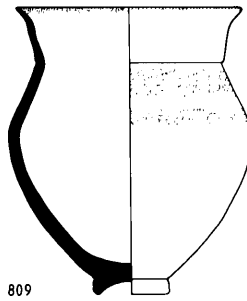
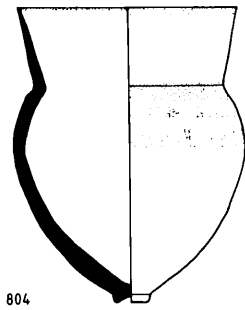
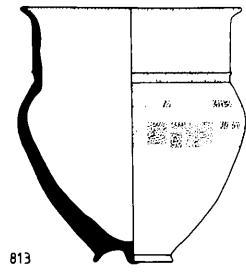
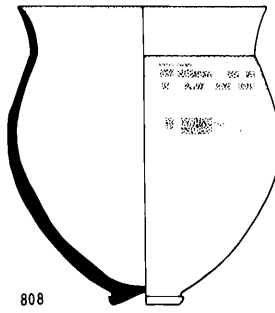
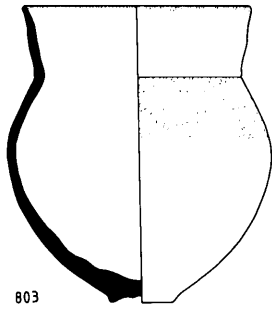

PLATE 76

PAINTED SHOULDERED BEAKERS – MITANNI AND OB

Pot No	TR No	Batch	Level	Dimensions	Range	Ware and Remarks
818		A 363	A 3	H: 1.8 cm W: 4.2 cm		Ware: fine buff. Temper: grit. Paint: black, worn. Rim sherd.
819		C	C 3	H: 3.8 cm W: 5.0 cm	A 3	Ware: very fine buff. Temper: grit. Paint: black, worn. Rim sherd.
820		A 563	A 2	H: 3.4 cm W: 3.9 cm	A 3	Ware: fine buff. Temper: grit. Paint: originally black, almost all flaked away. Rim sherd.
821		A 558	Topsoil	R: 8.0 cm H: 6.9 cm		Ware: fine buff. Temper: grit. Paint: black. Rim sherd.
822		A 597	A 3	R: 10.8 cm H: 6.0 cm	A 3	Ware: fine buff. Temper: fine grit. Paint: faded brown. Pattern indistinct. Rim sherd.
823		A 582	A 3	R: 8.0 cm H: 6.2 cm		Ware: fine buff. Temper: grit. Paint: faded red with splashes inside. Rim sherd.
824	6034	C 679 C 686	C 6a	R: 10.3 cm H: 7.8 cm	A 2-3 C 5	Ware: very fine buff. Temper: fine white grit. Paint: thick red to black. Base: missing. Pot P <i>Figure 11</i> . Almost complete. Plate 20b
825		A 380	A 3	H: 2.8 cm B: 1.7 cm	C 1-5	Ware: very fine buff. Temper: grit. Paint: black applied thickly. Base sherd.
826		C 674	C 6a	R: 8.0 cm H: 5.0 cm		Ware: fine salmon-pink. Temper: grit. Paint: red with splashes inside. Rim sherd. Plate 19e
827		A 720	A 3	R: 9.5 cm H: 3.8 cm		Ware: fine pale green. Temper: fine grit. Paint: dark brown, very worn. Rim sherd.
828		A 380	A 3	H: 2.6 cm W: 2.3 cm		Ware: fine buff. Temper: grit. Paint: black. Rim sherd.
829		A 376	A 2c	H: 6.0 cm W: 4.5 cm	C 6	Ware: medium fine green. Temper: grit. Paint: black, very worn. Rim sherd.
830		A 412	A 3	R: 7.7 cm H: 14.4 cm B: 3.0 cm		Ware: fine green. Temper: grit. Paint: brown, very faded. Profile.
831		A 599	A 3	H: 9.1 cm W: 12.2 cm	A 3 C 5	Ware: fine buff. Temper: grit and chaff. Paint: black with splashes inside. Rim sherd.
832		A 565	A 3	R: 10.7 cm H: 12.3 cm B: 4.0 cm	A 3 C 3	Ware: fine buff. Temper: grit and chaff. Paint: dark red with splashes inside. Profile.
833		C 85	C 6a	R: 10.5 cm H: 5.3 cm		Ware: fine buff. Temper: grit. Paint: dark, very worn. Rim sherd.
834			Unstratified	H: 4.2 cm W: 6.4 cm		Ware: fine green. Temper: grit. Paint: black, very worn. Bodysherd.
835		C 77	C 6a	R: 9.6 cm H: 3.5 cm		Ware: fine orange to brick red. Temper: grit. Paint: red, very thick with splashes inside. Rim sherd.
836		A 500	A 3	R: 9.0 cm H: 6.4 cm	A 3	Ware: fine buff. Temper: grit. Paint: dark red, faded. Rim sherd.
837		A	Unstratified	R: 7.2 cm H: 6.5 cm		Ware: fine orange-buff. Temper: fine grit. Paint: red. Rim sherd.
838		A 632	A 3	R: 5.9 cm H: 4.5 cm	A 1-3	Ware: fine cream. Temper: fine grit. Paint: dark brown. Rim sherd.
839		A 498	A 3	R: 8.0 cm H: 2.0 cm	C 5-6	Ware: fine buff. Temper: fine grit. Paint: black, faded. Rim sherd.
840		C 431	C 6a	R: 9.9 cm H: 7.6 cm	A 2	Ware: fine buff. Temper: fine grit. Paint: black. Rim sherd.

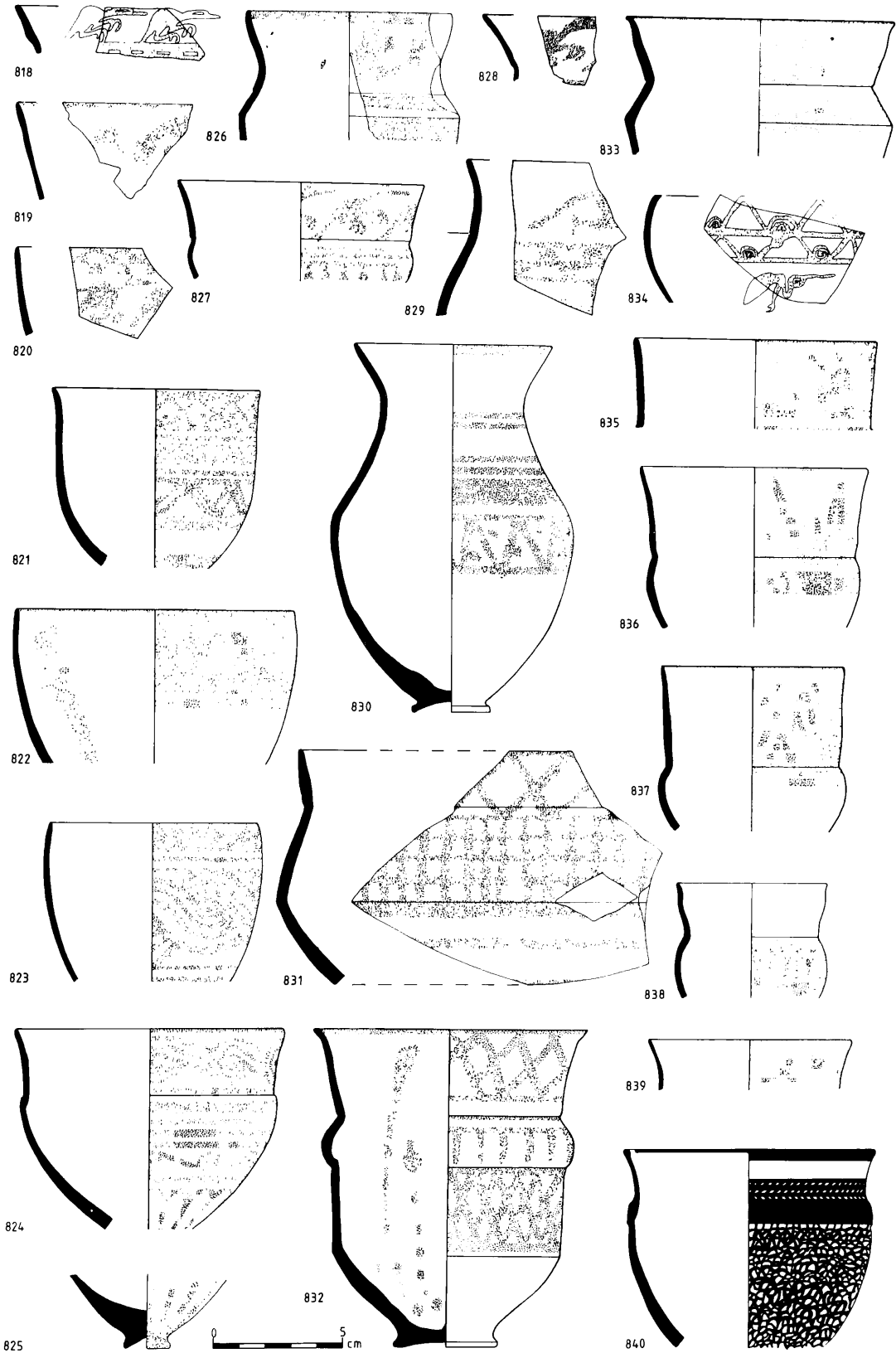

PLATE 77

LA AND MA CUPS AND MITANNI "GRAIN MEASURES"

Pot No	TR No	Batch	Level	Dimensions	Range	Ware and Remarks
841		C 186	C 1	R: 13.2 cm H: 12.8 cm	A Tops C 1	Ware: medium fine salmon-pink. Temper: grit and chaff. Surface: thick coating of bitumen inside, splashes outside. Profile.
842		C 111	Surface	R: 11.6 cm H: 13.0 cm	C 1	Ware: medium fine salmon-pink. Temper: grit and chaff. Rim: missing. Base: very uneven. Lower profile.
843		D 82	D 2	R: 11.2 cm H: 13.0 cm	C 1-2	Ware: medium fine buff. Temper: grit and chaff. Surface: thick coating of bitumen inside, splashes outside. Profile.
844		D 147	D 2	R: 10.7 cm H: 13.0 cm		Ware: medium fine buff. Temper: grit and fine chaff. Profile.
845		C 89	C 1	D: 10.3 cm H: 12.9 cm	C 2-3	Ware: medium coarse salmon-pink. Temper: grit and chaff. Surface: thick coating of bitumen inside and out. Rim: missing. Lower profile.
846		C 915	C 4	R: 9.0 cm H: 11.6 cm	A 2	Ware: coarse yellow. Temper: grit and chaff. Base: very uneven. Hand-made. Profile.
847		C 97	C 1	R: 8.0 cm H: 8.6 cm		Ware: medium fine green. Temper: grit. Profile.
848	3104	DG 16-66	D 2	R: 7.3 cm H: 8.0 cm		Ware: medium coarse buff. Temper: grit and chaff. Complete.
849		C	C 1	R: 5.8 cm H: 8.4 cm		Ware: medium fine red-buff. Temper: grit and chaff. Profile.
850		C 168	C 1	R: 5.8 cm H: 7.7 cm		Ware: medium fine salmon-pink. Temper: grit and chaff. Profile.
851		D 122	D ?	R: 5.3 cm H: 7.5 cm	A 2	Ware: medium fine light buff. Temper: chaff. Profile.

852		C 230	C 3	R: 13.5 cm H: 23.4 cm B: 9.0 cm		Ware: medium fine salmon-pink. Temper: grit and some chaff. Profile.
853		C 649	C 4	R: 13.4 cm H: 22.0 cm B: 7.5 cm		Ware: medium coarse buff. Temper: large white grit and chaff. Profile.
854		A 42	A 1	R: 9.5 cm H: 15.5 cm B: 5.2 cm	A 1	Ware: medium coarse buff. Temper: chaff. Profile.
855		C 358	C 4	R: 10.5 cm H: 15.0 cm B: 7.2 cm	A 2	Ware: medium fine pink. Temper: grit and chaff. Surface: traces of plaster coating inside. Profile.
856		A 57	A 2a-b	R: 13.8 cm H: 16.9 cm B: 6.8 cm	C 2-3	Ware: medium buff. Temper: grit and chaff. Profile.
857		A 473	A 1	R: 11.0 cm H: 15.7 cm B: 6.0 cm	A 2 C 5	Ware: medium coarse pink-buff. Temper: grit. Surface: coating of bitumen inside, splashes outside. Profile.
858	2109	A 32	A 2	R: 10.8 cm H: 15.9 cm B: 5.8 cm		Ware: medium coarse light green. Temper: small grit and chaff. Almost complete.
859		A 20	A 2a-b	R: 9.0 cm H: 12.2 cm B: 4.9 cm		Ware: medium fine pink. Temper: white grit and chaff. Profile.
860		C 706 C 712 C 731	C 4	R: 10.0 cm H: 18.2 cm B: 7.0 cm	A 1	Ware: medium coarse green. Temper: grit and chaff. Very warped and overfired. Profile.
861		A 20	A 2a-b	R: 10.8 cm H: 17.2 cm		Ware: medium coarse buff. Temper: grit and chaff. Base: missing. Upper profile.
862		C 944	C 4-5	R: 12.4 cm H: 15.0 cm		Ware: medium coarse green. Temper: grit and chaff. Base: missing. Upper profile.

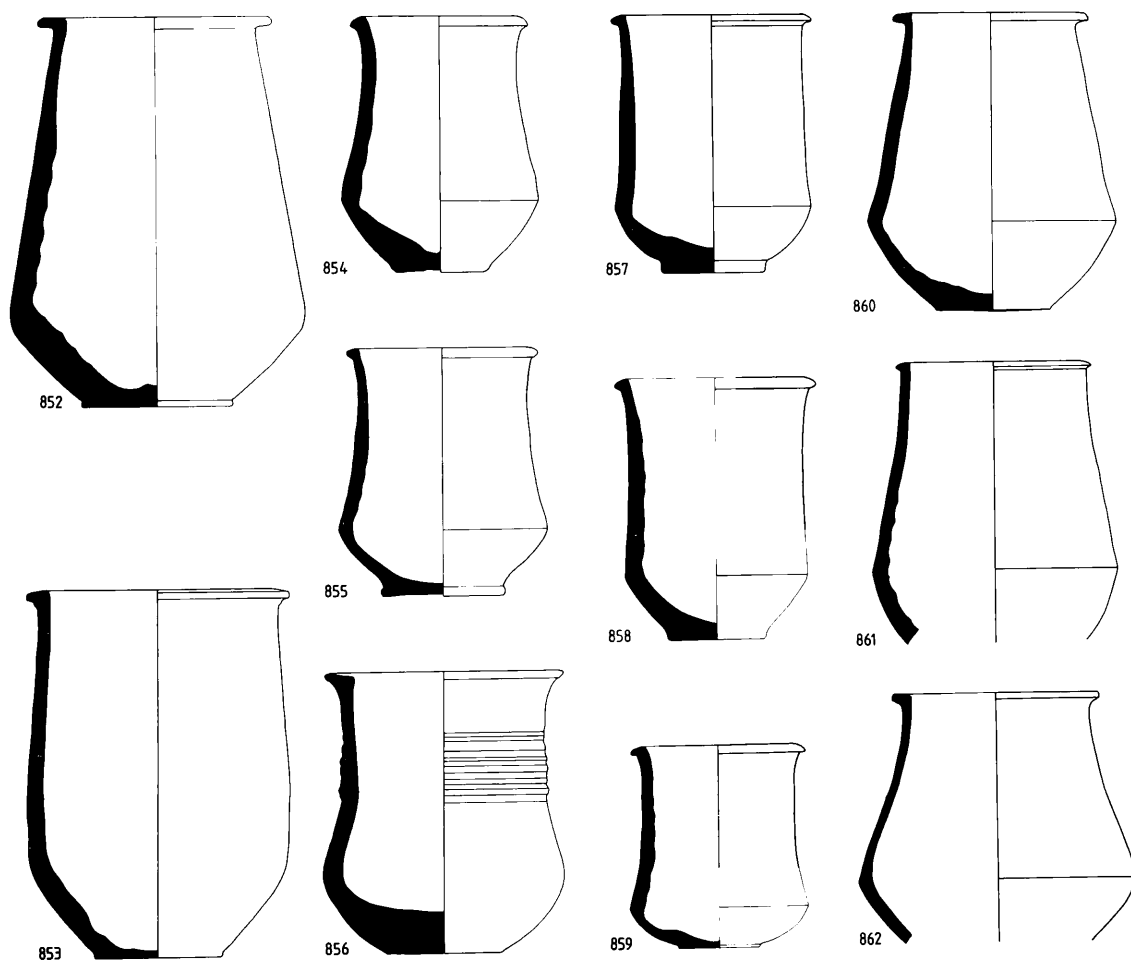
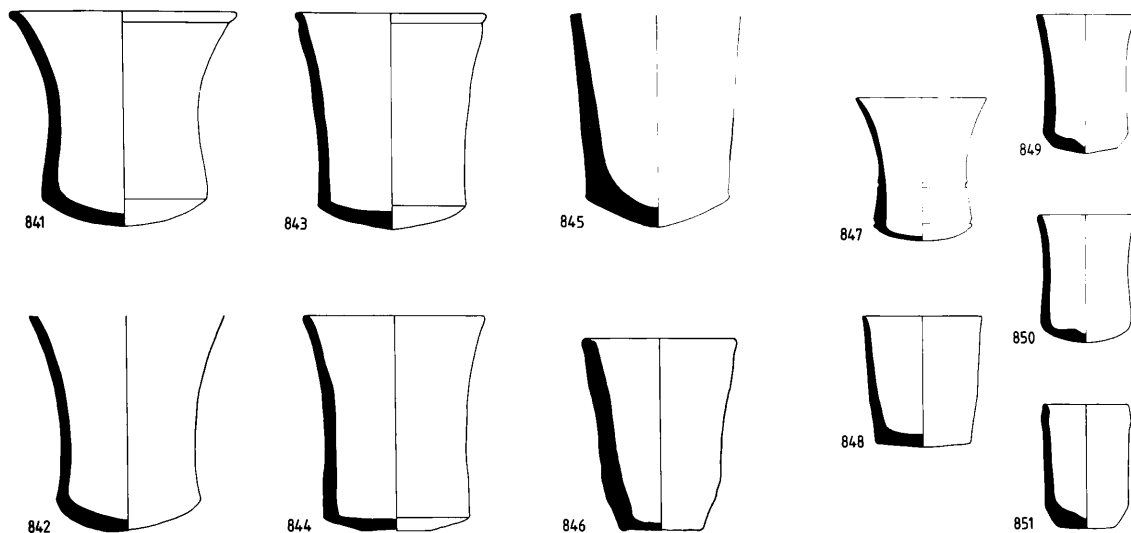

PLATE 78 PAINTED "GRAIN MEASURES" – MITANNI AND OLD BABYLONIAN

Pot No	TR No	Batch	Level	Dimensions	Range	Ware and Remarks
863		C 380	C 5b	R: 12.0 cm H: 18.7 cm B: 7.4 cm		Ware: medium fine buff. Temper: grit and chaff. Paint: black, worn in places. Pattern partly reconstructed. Profile.
864		A 254	Topsoil	R: 11.0 cm H: 12.0 cm	A 3-4	Ware: medium fine buff. Temper: grit and chaff. Paint: brick red with splashes inside and a group of strokes on rim. Pattern: partly reconstructed. Base: missing. Rim sherd.
865		C 589	C 6a	R: 15.8 cm H: 8.5 cm	A Tops	Ware: medium fine green. Temper: grit. Paint: dark brown applied thickly. Rim sherd.
866		C 20	C 6a	R: 9.0 cm H: 6.6 cm	A 2-3 C 5	Ware: medium fine green. Temper: grit and chaff. Paint: purple-brown with splashes inside and triangles on rim. Rim sherd.
867		A 312	A 2c	H: 2.5 cm W: 4.6 cm		Ware: medium fine green. Temper: grit. Paint: black, very worn. Rim sherd.
868		C 396	C 5b	H: 7.1 cm W: 6.7 cm		Ware: medium fine very pale green. Temper: fine grit. Paint: dark brown, very faded. Bodysherd.
869			Surface	H: 6.9 cm W: 6.1 cm		Ware: medium coarse buff to red. Temper: chaff. Paint: red with splashes inside. Bodysherd.
870	153	C	C 5	R: 16.5 cm H: 22.4 cm B: 9.0 cm	A 3 C 2	Ware: medium fine buff to light orange. Temper: grit and chaff. Paint: light to dark brown with splashes inside. Almost complete.
871		A 599 A 706	A 3	R: 16.5 cm H: 16.5 cm	C 5	Ware: medium coarse brick red, fired pink to white in places, with grey core. Temper: grit and chaff. Paint: red-brown. Base: missing. Upper profile.
872		A 434 A 585 A 586	A 3 late	R: 16.0 cm H: 11.0 cm	A 3 C 6	Ware: medium coarse buff. Temper: grit and chaff. Paint: red with widely-spaced strokes on rim. Base: missing. Rim sherd. Plate 19a
873		A 99	A 2c	R: 15.0 cm H: 17.0 cm	C 5	Ware: medium fine light buff. Temper: grit and chaff. Surface: smoothed. Paint: dark brown with splashes inside. Base: missing. Upper profile.
874		C 939	C 4-5	R: 14.0 cm H: 16.2 cm	C 1-6	Ware: medium coarse green. Temper: grit and chaff. Paint: yellow-brown, very faded and flaked. Base: missing. Profile.
875		A 650	A 4	R: 11.0 cm H: 13.3 cm	A 2a-3 C 5-6	Ware: medium fine buff. Temper: grit and chaff. Paint: plum-red. Base: missing. Upper profile.
876		A 584	A 3	R: 15.5 cm H: 11.0 cm	A 3	Ware: medium fine green-buff, overfired. Temper: grit and chaff. Paint: dark brown, very faded. Base: missing. Rim sherd. Plate 19c
877		A 599 A 706 A 709	A 3	H: 19.2 cm B: 10.0 cm	A 3 C 1-5	Ware: coarse green, brittle and overfired. Temper: grit and chaff. Paint: dark brown. Rim: missing. Lower profile.
878	5003	A 618	A 2-3	H: 17.0 cm B: 6.6 cm	C 2-6	Ware: medium fine buff. Temper: large white grit and chaff. Paint: red-brown. Rim: missing. Base sherd.

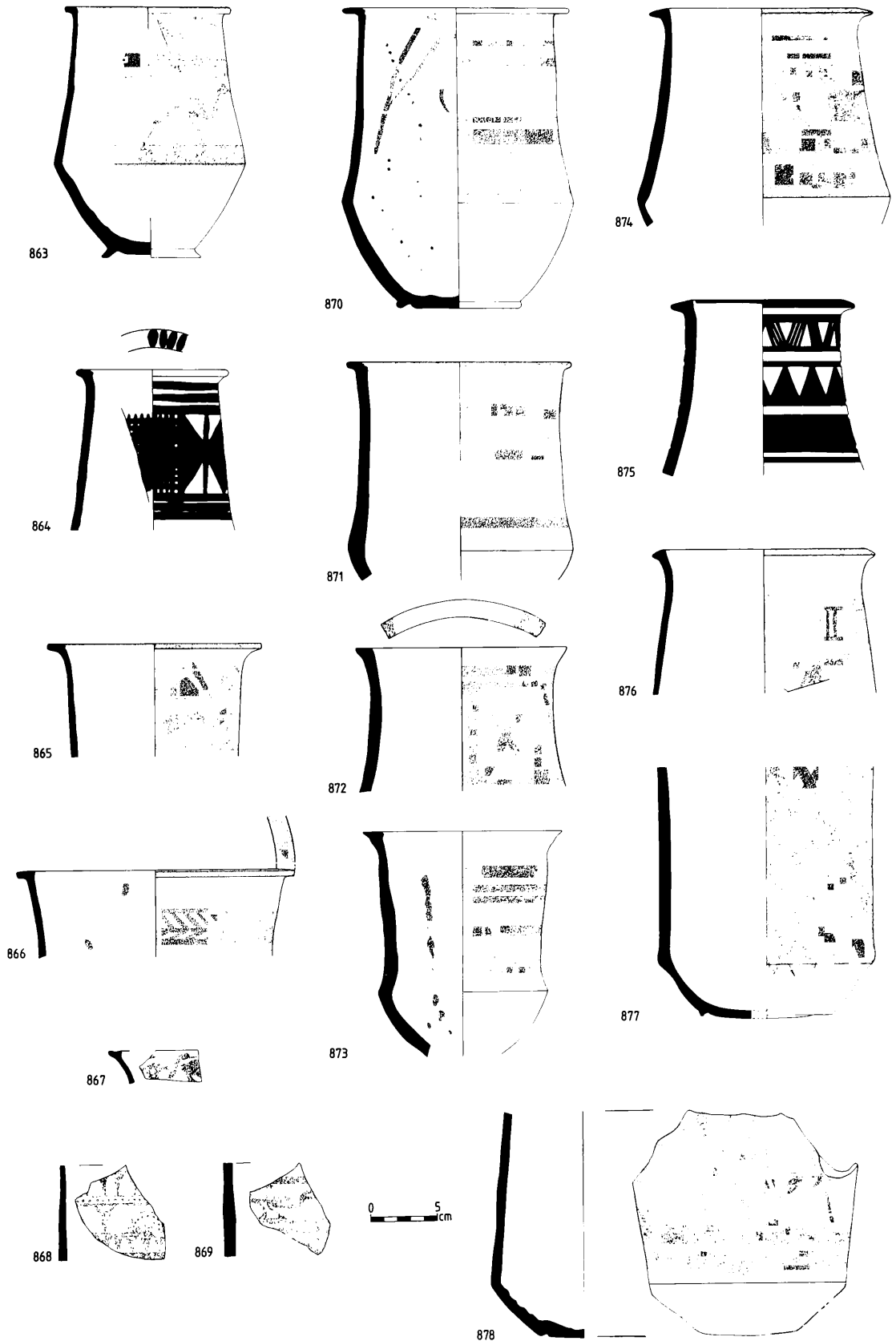

PLATE 79

SMALL SHOULDERED BEAKERS – OLD BABYLONIAN

Pot No	TR No	Batch	Level	Dimensions	Range	Ware and Remarks
879		C 459	C 7	R: 9.4 cm H: 8.3 cm B: 3.3 cm	C 5	Ware: fine cream. Temper: fine grit. Surface: well smoothed. Profile.
880		A 630	A 4	R: 9.6 cm H: 4.5 cm	C 6	Ware: fine pink-buff. Temper: fine grit. Base: missing. Rim sherd.
881		C 87	C 5b	R: 7.2 cm H: 3.5 cm	A 3 C 6	Ware: fine pink-brown. Temper: fine grit. Base: missing. Rim sherd.
882		A 469	Mixed	R: 9.2 cm H: 6.2 cm		Ware: medium fine pale orange. Temper: grit and chaff. Paint: red, pattern reconstructed. Base: missing. Rim sherd.
883		A 459	A 2c	R: 8.0 cm H: 4.7 cm	A 2-3	Ware: fine green-buff. Temper: grit. Paint: green-black. Base: missing. Rim sherd.
884		A 709	A 3	R: 10.0 cm H: 5.6 cm	A 3	Ware: fine cream. Temper: fine grit. Paint: dark brown to black. Base: missing. Rim sherd.
885		A 601	A 3	R: 11.4 cm H: 5.3 cm	A 3	Ware: fine buff. Temper: fine grit. Paint: dark brown. Base: missing. Rim sherd.
886		A 250	A 1	R: 4.0 cm H: 2.1 cm		Ware: fine yellow-buff. Temper: grit. Handmade. Paint: purple. Base: missing. Rim sherd.
887		A 364	A 3	R: 3.6 cm H: 2.3 cm		Ware: fine buff. Temper: fine grit and chaff. Handmade. Paint: red. Base: missing. Rim sherd.
888		A 208 A 282	A 1	R: 4.0 cm H: 2.7 cm	A 3	Ware: fine yellow-buff. Temper: grit. Handmade. Paint: red. Base: missing. Rim sherd.
889		C 968	C 6	R: 4.0 cm H: 2.2 cm	C 6	Ware: fine green. Temper: grit. Handmade. Paint: brown. Base: missing. Rim sherd.
890		A 482	A 3	R: 10.0 cm H: 3.5 cm	A LA-2 C 1-5	Ware: fine pink-buff. Temper: fine grit. Paint: purple, applied thickly. Base: missing. Rim sherd.
891		A 669	A 3	R: 10.0 cm H: 4.5 cm	A 1-4 C 1-7	Ware: fine pink to white. Temper: white grit and fine chaff. Paint: red. Base: missing. Rim sherd.
892		D 36	D 3	R: 10.0 cm H: 3.0 cm	A 2-3 C 5-6	Ware: fine pale buff. Temper: grit. Paint: black. Base: missing. Rim sherd.
893		A 361	A 3	R: 8.7 cm H: 3.1 cm	A 1 C 7	Ware: fine pale buff. Temper: grit. Paint: black. Base: missing. Rim sherd.
894		A 220	A 2c	R: 8.6 cm H: 4.0 cm	C 5-6	Ware: fine pink-buff. Temper: grit. Paint: orange. Base: missing. Rim sherd.
895		A 640	A 3	R: 7.3 cm H: 5.7 cm	A LA-3 C 6-7	Ware: fine buff. Temper: grit. Paint: dark brown. Base: missing. Rim sherd.
896		A 606 A 609	A 4	R: 9.1 cm H: 4.8 cm	A 1-3 C 5-6	Ware: fine buff. Temper: grit. Paint: dark brown. Base: missing. Rim sherd.
897		A 269	A 1	R: 6.4 cm H: 3.4 cm	A LA C 5-6	Ware: fine green. Temper: grit. Paint: brown. Base: missing. Rim sherd.
898		A 565	A 3	R: 10.0 cm H: 3.5 cm	C 5-6	Ware: medium fine buff. Temper: grit and chaff. Paint: dark red, faded. Base: missing. Rim sherd.

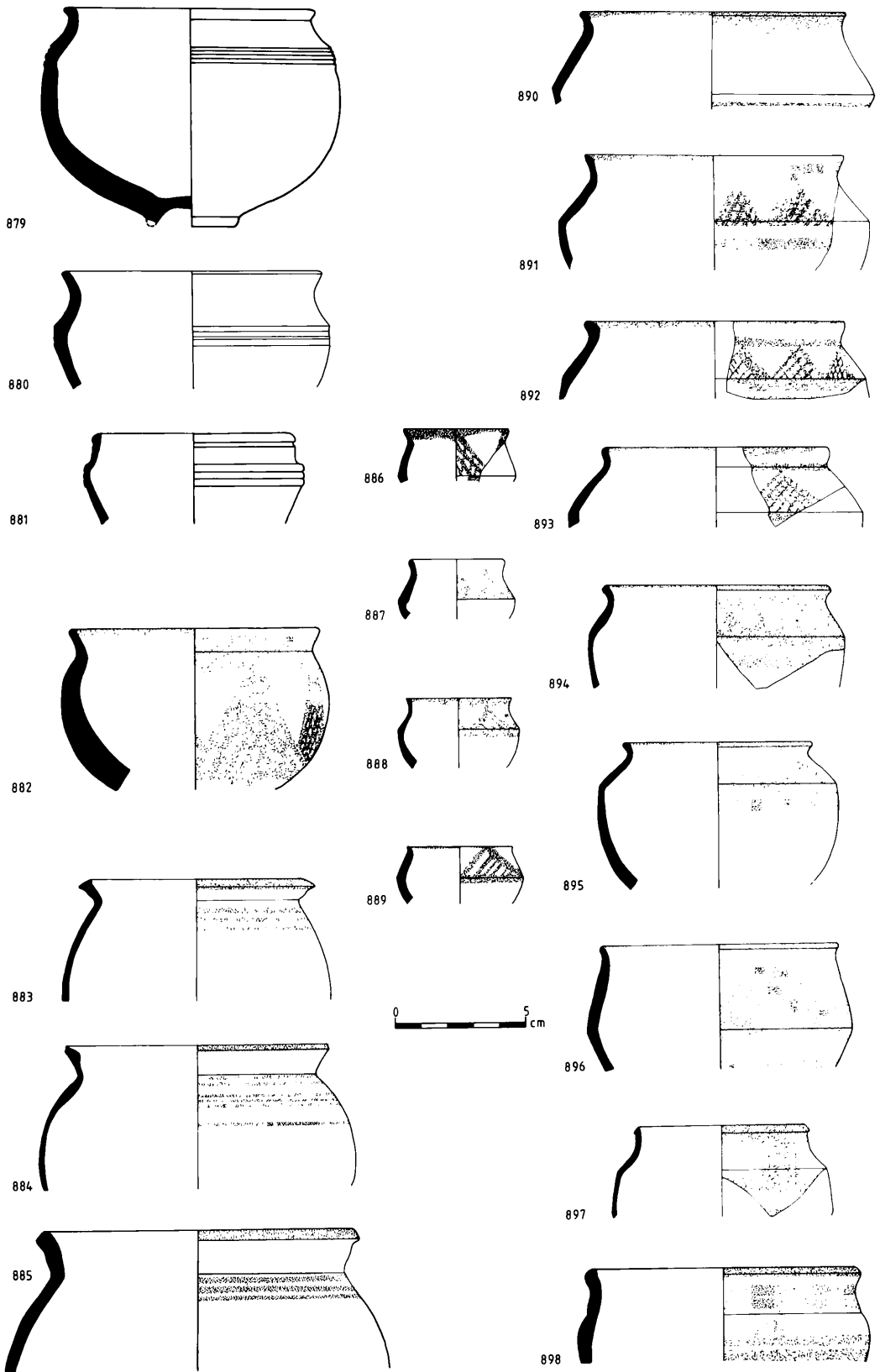

PLATE 80

MINIATURE VESSELS

Pot No	TR No	Batch	Level	Dimensions	Range	Ware and Remarks
899	184	C	C 2	R: 5.5 cm H: 8.9 cm		Ware: medium coarse green to orange. Temper: grit and chaff. Complete.
900		C 540	C 5	R: 6.0 cm H: 8.0 cm	A 2	Ware: medium coarse green. Temper: grit and chaff. Profile.
901		A 98	A 2a	R: 4.9 cm H: 6.9 cm		Ware: medium fine buff. Temper: grit and some fine chaff. Profile.
902	4126	A 565	A 3	R: 4.2 cm H: 5.2 cm	C 5	Ware: fine yellow-buff. Temper: grit. Paint: black, applied in irregular horizontal bands. Base: string-cut. Almost complete.
903		A 599	A 3	H: 4.2 cm B: 1.9 cm		Ware: fine cream. Temper: grit. Paint: red-brown. Base: string-cut. Rim: missing. Base sherd.
904	6047	C 919	C 6	H: 4.2 cm B: 1.6 cm		Ware: fine pink. Temper: grit. Base: string-cut. Rim: missing. Almost complete.
905	5000	A 611	A 3	R: 3.7 cm H: 7.9 cm	A Tops	Ware: fine light green. Temper: grit. Paint: dark brown. Base: string-cut. Complete.
906		A 552	A 3	R: 3.0 cm H: 3.1 cm	A Tops	Ware: fine buff. Temper: grit. Paint: dark red. Base: missing. Rim sherd.
907		A 565	A 3	H: 7.5 cm B: 3.0 cm	C 5b	Ware: fine buff. Temper: grit and chaff. Paint: brown, very faded. Base: string-cut. Rim: missing. Lower profile.
908	4108	C 29	C 6a	R: 2.2 cm H: 6.2 cm	A 1-2c C 5-6a	Ware: fine light buff. Temper: grit and chaff. Paint: red, very faded. Base: string-cut. Almost complete.
909		A 484	A 3	H: 8.0 cm B: 2.8 cm	A 1 C 6a	Ware: fine green-buff, warped. Temper: grit. Paint: red, very faded. Base: string-cut. Rim: missing. Found in Pot 595 with Pot 911. Lower profile.
910		A 709	A 3	H: 6.4 cm B: 2.7 cm		Ware: fine pink-buff. Temper: fine grit. Paint: black. Base: string-cut. Rim: missing. Lower profile.
911		A 484	A 3	H: 7.0 cm B: 2.3 cm		Ware: fine pink-buff. Temper: grit. Paint: black. Base: string-cut, then smoothed. Rim: missing. Found in Pot 595 with Pot 909. Lower profile.
912		A 572	A 3	H: 4.0 cm B: 2.1 cm		Ware: fine buff. Temper: grit and chaff. Paint: purple. Base: string-cut. Rim: missing. Lower profile.
913	5017	A 705	A 3	R: 3.9 cm H: 6.2 cm		Ware: fine red-buff. Temper: grit and chaff. Paint: dark brown. Base: string-cut, very uneven. Almost complete.
914	5007	A 653	A 4-5	R: 3.7 cm H: 6.8 cm		Ware: medium coarse red-brown. Temper: grit and chaff. Hand-made, very uneven. Complete.
915		A 491	A 3	R: 9.0 cm H: 5.6 cm		Ware: medium coarse buff. Temper: grit and chaff. Surface: traces of bitumen coating inside and out. Profile.
916		Unstratified	A 3	R: 5.8 cm H: 5.2 cm		Ware: fine cream. Temper: grit and little chaff. Paint: dark to light brown, very faded. Base: broken. Rim sherd.
917		C 323	C 5	R: 6.0 cm H: 5.5 cm		Ware: medium fine salmon-pink. Temper: white grit. Base: missing. Rim sherd.
918		C 288	C 3	R: 4.5 cm H: 4.5 cm		Ware: medium fine buff. Temper: fine grit. Base: string-cut. Profile.
919	3139	A 497	A 3	R: 2.5 cm H: 3.2 cm		Ware: medium coarse buff. Temper: chaff. Handmade, very uneven. Complete.
920	163	A 69	A 2b	R: 4.0 cm H: 8.2 cm		Ware: medium fine buff. Temper: grit. Surface: glaze inside and out, possibly originally green. Complete.
921	165	A 81	A 1-2	R: 4.2 cm H: 6.0 cm		Ware: medium fine buff. Temper: grit. Surface: glaze inside and out, possibly originally light green. Complete.
922	3138	D	D 1	R: 6.0 cm H: 2.9 cm		Ware: medium fine green. Temper: grit. Surface: glaze inside and out on rim in places, blue-green. Complete.

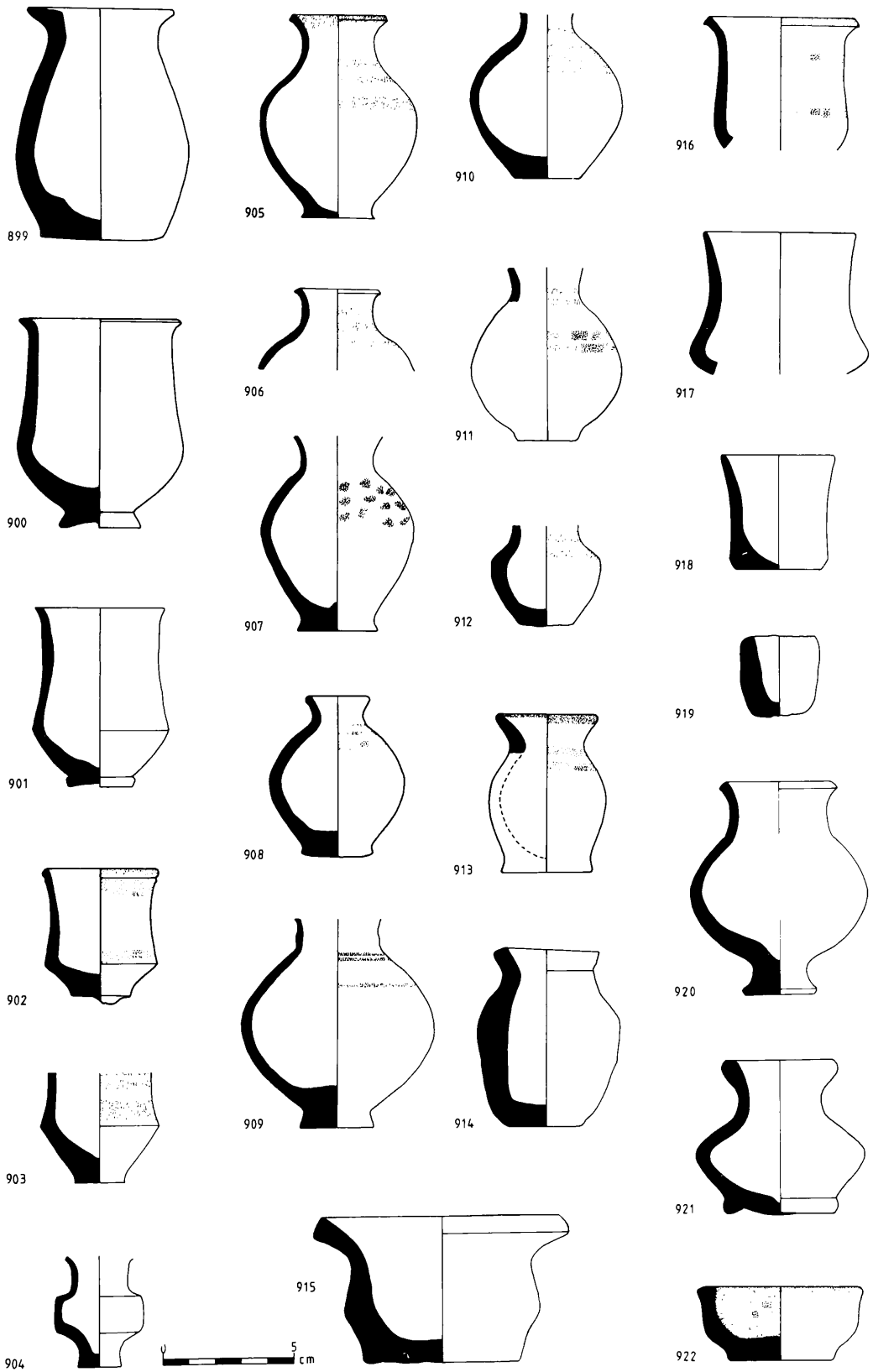

PLATE 81

SMALL JARS AND BOTTLES

Pot No	TR No	Batch	Level	Dimensions	Range	Ware and Remarks
923		C 507	C 1	R: 6.8 cm H: 11.5 cm	C 1	Ware: medium coarse buff. Temper: grit and chaff. Profile.
924		C	C 1	R: 6.8 cm H: 14.0 cm	C 1	Ware: medium fine buff. Temper: grit and chaff. Surface: thick bitumen coating outside and splashes inside. Profile.
925		C 181	C 1	D: 9.0 cm H: 13.0 cm	C 1	Ware: medium coarse buff. Temper: grit. Surface: blue glaze outside. Rim: missing. Profile.
926		C 714	C 1-2	D: 9.0 cm H: 10.8 cm		Ware: medium fine buff. Temper: grit. Surface: thick bitumen coating outside and in. Rim: missing. Base: broken. Almost complete.
927	5004	C 198	C 1	R: 3.5 cm H: 11.7 cm	A 2a	Ware: medium coarse red-buff. Temper: grit. Surface: bitumen stains on rim and inside neck. Almost complete.
928	5001	C 110	C 1	R: 1.6 cm H: 11.0 cm		Ware: medium fine salmon-pink. Temper: grit. Complete. Plate 26c
929	162	A 69	A 2b	R: 3.0 cm H: 6.8 cm		Ware: medium coarse light grey-green. Temper: grit and chaff. Base: off-axis. Complete.
930	158	A 81	A 1-2	R: 4.0 cm H: 9.3 cm		Ware: medium fine grey. Temper: grit and chaff. Surface: well smoothed. Complete.
931	2102	A 72 A 74 A 88 A 90	A 2a	R: 3.0 cm H: 8.0 cm		Ware: medium coarse light buff. Temper: white grit and chaff. Base: scraped. Almost complete.
932	2136	A 305	A 1	R: 5.0 cm H: 7.3 cm		Ware: medium coarse pale green. Temper: grit and chaff. Almost complete.
933	2142	A 310	A 2	H: 10.2 cm B: 2.8 cm		Ware: medium fine buff ware. Temper: grit and chaff. Paint: brown, very faded. Surface: burnished. Base: small hole drilled in centre D: 0.4 cm. Rim: missing. Almost complete.
934		A 336	A 2a-b	R: 3.5 cm H: 8.3 cm	A 2a	Ware: medium fine dark buff to red. Temper: white grit. Profile.
935	4112	A 585	A 3	R: 3.6 cm H: 8.5 cm	C 4-5	Ware: medium fine buff. Temper: grit and chaff. Surface: very burnt. Complete.
936	2106	A 72 A 74 A 88 A 90	A 2a	R: 5.6 cm H: 13.8 cm		Ware: medium fine light green. Temper: grit and chaff. Almost complete.
937	157	A	A 2	R: 6.2 cm H: 13.0 cm		Ware: fine light green to orange. Temper: grit and chaff. Almost complete.
938	2137	A 352	A 2a-b	R: 7.8 cm H: 11.1 cm	C 3	Ware: medium coarse buff to pink. Temper: grit and chaff. Almost complete.
939	5048	C	C 2-3	R: 5.6 cm H: 11.5 cm		Ware: medium fine red. Temper: fine grit. Almost complete.
940	151	C	Surface	R: 5.7 cm H: 10.9 cm		Ware: medium fine light green. Temper: grit and chaff. Almost complete.
941	183	A 61	A 1	R: 4.2 cm H: 11.1 cm	A 2a C 3-5	Ware: medium fine light green. Temper: fine white grit and fine chaff. Complete.
942		A 461	A 1	R: 8.6 cm H: 11.8 cm		Ware: medium fine red. Temper: grit and chaff. Surface: coating of bitumen inside and out. Profile.
943		C 111	Surface	R: 6.4 cm H: 10.5 cm		Ware: medium fine salmon-pink. Temper: grit and chaff. Surface: coating of plaster inside and out. Profile.
944		A 400	A 1	R: 6.0 cm H: 10.5 cm		Ware: medium coarse buff. Temper: chaff. Profile.
945	3112	DG 7-66	D 2	R: 6.3 cm H: 8.2 cm	A Tops	Ware: fine dark buff, overfired and blackened. Temper: grit. Decoration: incised combed horizontal band. Complete. Plate 17e
946		D 47	D 2	R: 9.0 cm H: 9.5 cm	A LA-1	Ware: medium coarse red. Temper: grit and chaff. Surface: coating of bitumen inside. Profile.
947	160	A 72 A 74 A 88 A 90	A 2a	R: 6.4 cm H: 8.9 cm	A 2	Ware: medium fine light buff. Temper: grit and chaff. Almost complete.

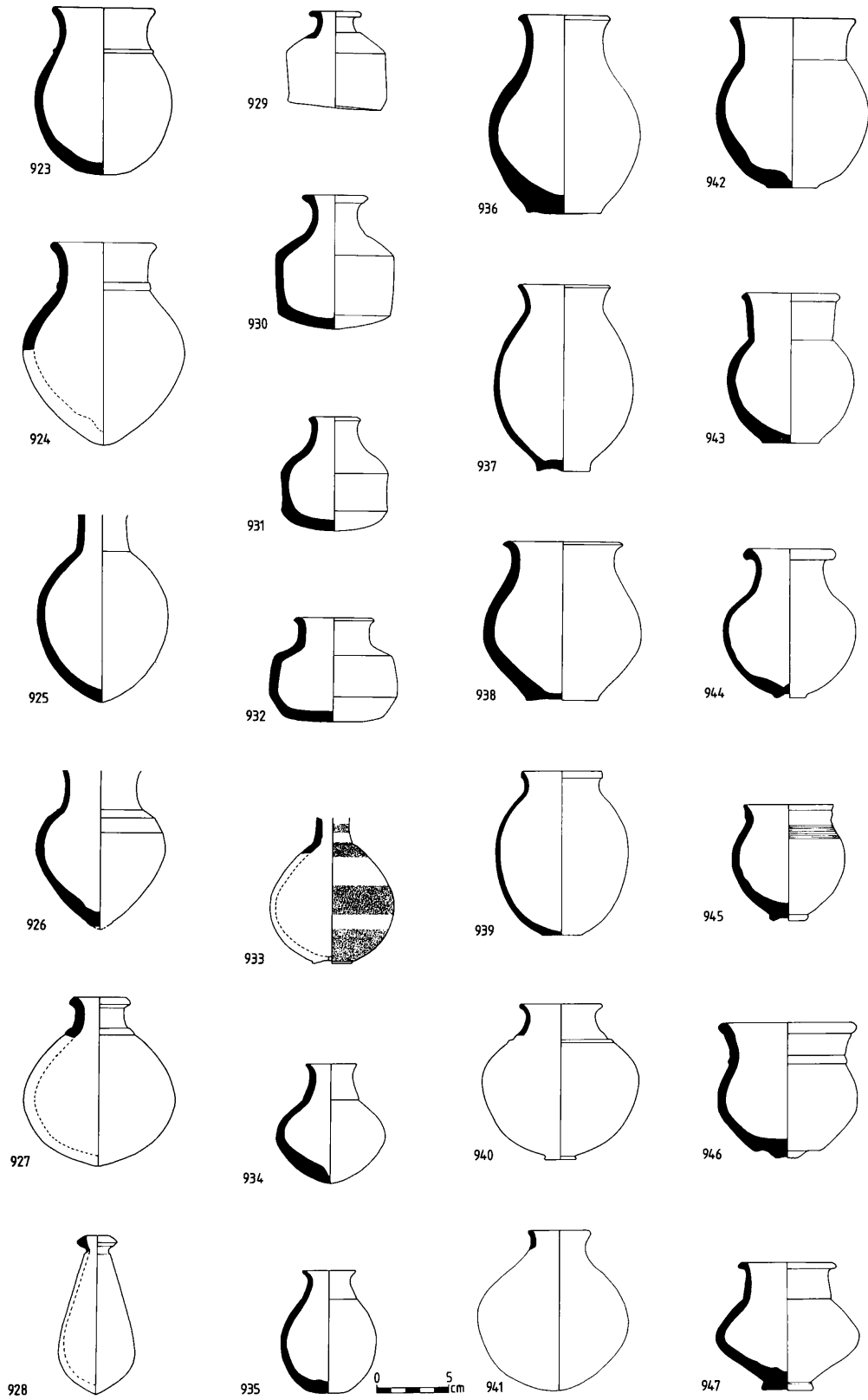
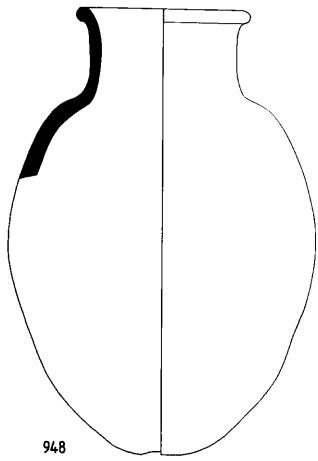

PLATE 82

SMALL JARS

Pot No	TR No	Batch	Level	Dimensions	Range	Ware and Remarks
948	4116	A 592 LA shrine	A LA	R: 10.0 cm H: 26.7 cm B: 2.5 cm	C 1	Ware: medium coarse buff. Temper: grit. Surface: dark blue-green glaze outside over all and inside on neck and rim. Found <i>in situ</i> on potstand Pot 1137. Complete. Plate 26a,b
949	3119	DG 3-66	D 2	R: 10.8 cm H: 26.8 cm B: 4.0 cm	A 1	Ware: coarse green. Temper: grit and chaff. Decoration: seven lines of incised combing at base of neck. Complete. Plate 17f
950	5025	C 308 CG 13-68	C 1	R: 9.3 cm H: 24.0 cm B: 4.0 cm	C 1	Ware: medium coarse red-buff. Temper: grit and chaff. Found at feet of skeleton. Complete.
951	6002	CG 5-71	C 1	R: 8.2 cm H: 19.2 cm B: 1.0 cm	C 1	Ware: medium coarse red. Temper: grit and chaff. Found near feet of skeleton. Complete.
952	5008	C 227	C 2	R: 8.8 cm H: 20.2 cm B: 4.4 cm	A 2a	Ware: medium fine buff. Temper: grit and chaff. Almost complete.
953		C	C 1-3	R: 9.0 cm H: 21.3 cm B: 7.5 cm	A 2 C 2-3	Ware: medium coarse red-buff. Temper: grit and chaff. Almost complete.
954	2125	A 336	A 2a-b	R: 7.8 cm H: 15.9 cm B: 7.3 cm	C 3-4	Ware: medium coarse red-buff. Temper: white grit and chaff. Almost complete.
955		C 514 C 519 C 521 C 531	C 3	R: 10.5 cm H: 20.0 cm B: 8.6 cm		Ware: medium coarse green-buff. Temper: grit and chaff, the latter leaving rather a rough surface. Profile.
956	168	A	A 1	R: 9.0 cm H: 19.3 cm B: 8.2 cm		Ware: medium coarse orange. Temper: chaff. Paint: red wash inside. Complete.
957		C 677	C 5	R: 9.0 cm H: 20.5 cm B: 10.6 cm	C 5	Ware: medium coarse buff. Temper: grit and much chaff. Base: missing, probably rounded. Upper profile.
958		C 651	C 5	R: 10.0 cm H: 17.2 cm B: 8.1 cm		Ware: medium fine red. Temper: grit. Surface: orange-red burnished outside and on rim with horizontal marks. Inside surface is almost entirely flaked away, therefore the profile thickness is uncertain. Profile.



948

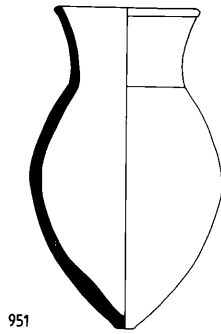

951

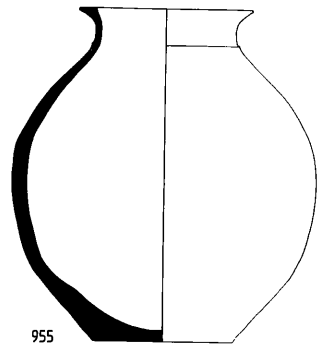

955

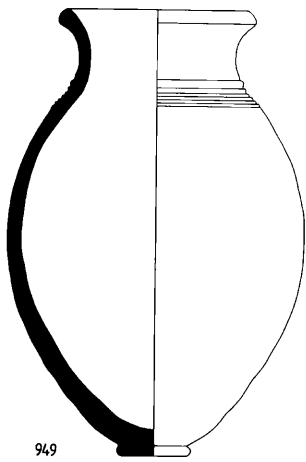

949

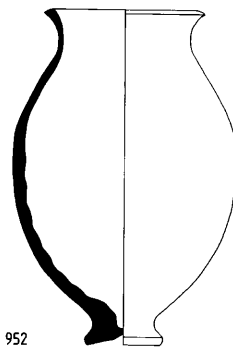

952

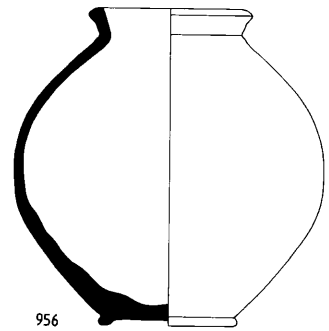

956

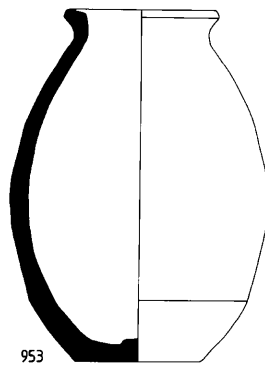

953

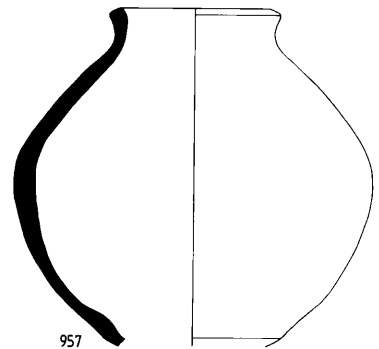

957

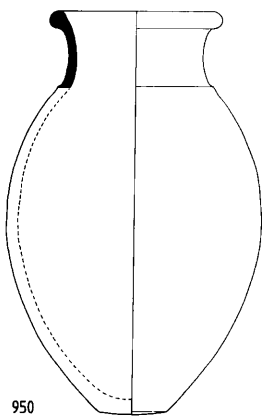

950

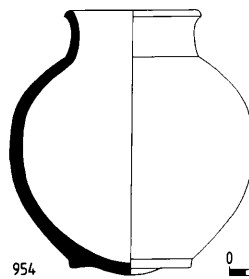

954

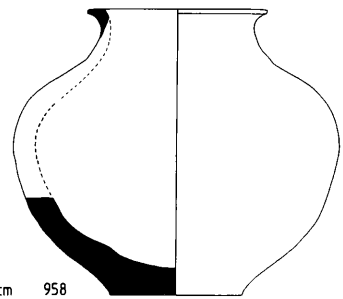

958

PLATE 83

SMALL JARS AND JUGS

Pot No	TR No	Batch	Level	Dimensions	Range	Ware and Remarks
959		A 336	A 2a-b	R: 4.4 cm H: 16.4 cm B: 5.6 cm	A 3	Ware: medium fine red. Temper: white grit and chaff. Handles: two pierced lugs on opposite sides of jar. Profile.
960		C 649	C 4	R: 4.9 cm H: 22.0 cm B: 9.0 cm	C 1-4	Ware: medium coarse red to white with black to buff core. Temper: grit and much chaff. Handles: two pierced uneven lugs on opposite sides of jar. Base: very cracked in firing and coated outside with much plaster. Profile.
961		A 225	A 1	R: 18.0 cm H: 17.3 cm B: 8.8 cm	A 1-2a C 1	Ware: coarse buff. Temper: chaff. Handles: three evenly-spaced solid vertical lugs. Profile.
962	2121	A 307	A 2a-b	R: 19.0 cm H: 21.0 cm B: 10.6 cm		Ware: medium coarse pale green. Temper: grit and chaff. Complete.
963	2143	A 307	A 2a-b	R: 10.6 cm H: 20.8 cm B: 6.0 cm		Ware: coarse buff. Temper: grit and chaff. Handmade. Surface: traces of thick encrustation of bitumen outside. Base: lopsided with large hole D: 6.0 cm covering total area of base. Decoration: grooves at neck. Complete.
964	2130	C	C 2-3	R: 6.4 cm H: 20.0 cm B: 2.0 cm		Ware: coarse pink-buff. Temper: grit and chaff. Handmade. Rim: pinched to make a flaring rim with finger-marks on the outside. Base: small hole D: 2.0 cm covering total area of base. Almost complete.
965	4115	A 589	A 3	R: 8.0 cm H: 19.5 cm B: 11.0 cm		Ware: medium coarse orange-buff. Temper: grit and chaff. Complete. Two ivory buttons found inside this jar (TR 4806 and Reg. No. A 126).
966	150	A 72 A 74 A 88 A 90	A 2a	R: 6.8 cm H: 13.9 cm B: 6.0 cm		Ware: coarse orange. Temper: grit and chaff. Surface: smoothed. Handle: high vertical strap. Rim: pinched to form pouring lip. Complete.
967		A 336	A 2a-b	R: 9.0 cm H: 22.8 cm B: 7.0 cm		Ware: medium coarse buff. Temper: grit and chaff. Handle: vertical strap with thumb-impressed indentation at top. Rim: pinched to form pouring lip opposite handle. Profile.
968		C 222	C 2-3	R: 4.4 cm H: 21.0 cm	A 2a	Ware: medium fine red-buff with grey core. Temper: some grit and chaff. Slip: bright red outside. Surface: highly burnished. Handle: vertical strap with slight vertical groove down centre. Base: missing. Upper profile.

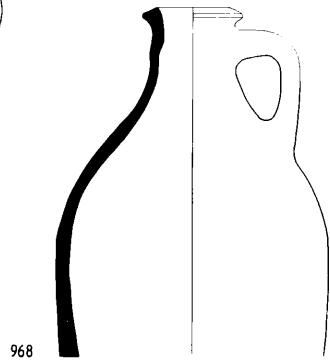
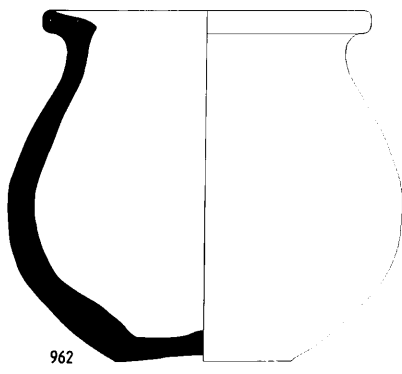
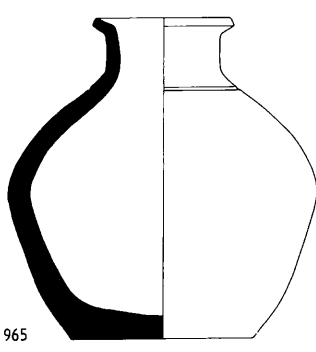
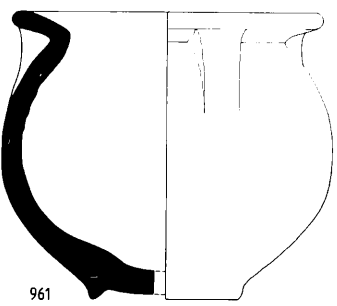
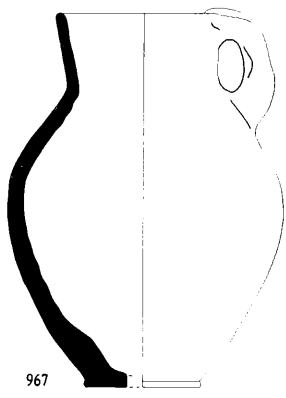
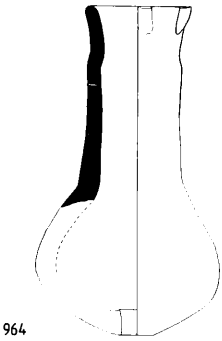
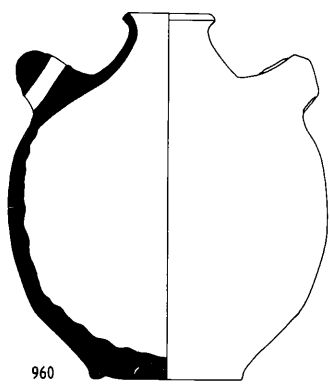
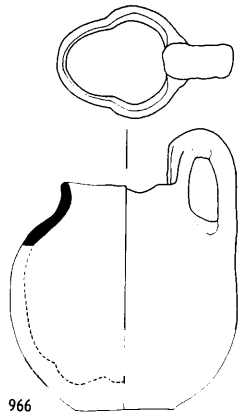
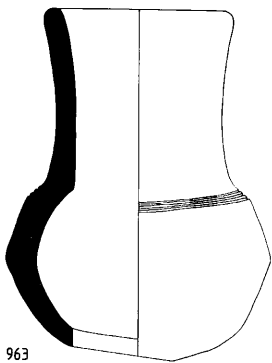
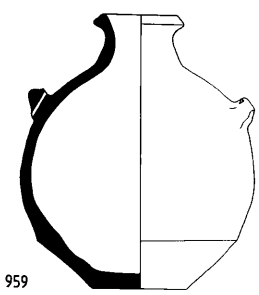

PLATE 84

JARS – ISLAMIC – PARTHIAN – SASSANIAN

Pot No	TR No	Batch	Level	Dimensions	Range	Ware and Remarks
969	5020	A 682	Topsoil pit	R: 16.0 cm H: 39.5 cm B: 14.5 cm		Ware: medium coarse pale green-buff. Temper: grit. Handles: three vertical strap. Surface: coating of bitumen on rim and over all inside, with random blobs on neck and shoulder. Decoration: incised combed horizontal and wavy bands. Complete.
970	5027	A 682	Topsoil pit	D: 32.0 cm H: 44.0 cm		Ware: medium coarse buff. Temper: grit and chaff. Handles: two vertical strap. Rim: missing. Decoration: incised combed horizontal and wavy bands. Almost complete.
971	5029	A 682	Topsoil pit	R: 12.0 cm H: 31.7 cm B: 10.0 cm		Ware: medium coarse brick red. Temper: white grit. Decoration: incised combed horizontal bands. Almost complete.
972		D 96	D 1	R: 9.0 cm H: 45.8 cm B: 11.5 cm		Ware: coarse red-buff. Temper: grit and chaff. Handles: two vertical strap. Decoration: incised combed horizontal and wavy bands. Profile.
973		D 11	D 1	R: 18.0 cm H: 24.0 cm B: 17.0 cm		Ware: coarse red to brown. Temper: very large white grit. Probably handmade. Base: much blackened, possibly from use as a cooking-pot. Handles: originally two vertical, square in cross-section, with applied castellations at top and vertical groove at centre leading to thumb-impressed hollow at join with shoulder of jar. Decoration: incised wavy lines between which is an applied zig-zag band decorated with slashes. Almost complete.
974	3114	A 424	Topsoil	D: 14.4 cm H: 16.3 cm B: 8.2 cm		Ware: medium fine green. Temper: grit. Surface: traces of brownish-green glaze over all. Handles: two small vertical with grooves running down centre. Rim: missing. Decoration: incisions and ridges at base of neck. Almost complete.
975	5028	A 682	Topsoil pit	R: 9.5 cm H: 26.7 cm B: 11.5 cm		Ware: medium coarse red. Temper: grit. Decoration: horizontal grooves. Almost complete.

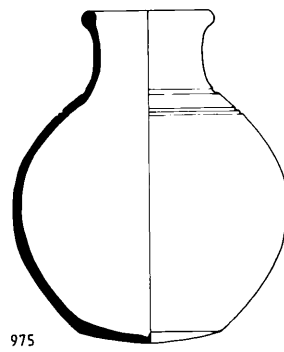
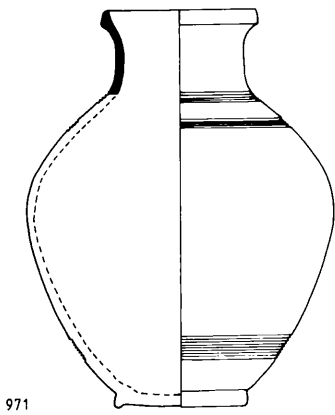
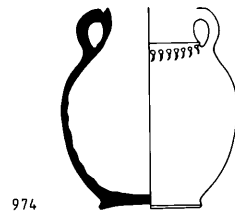
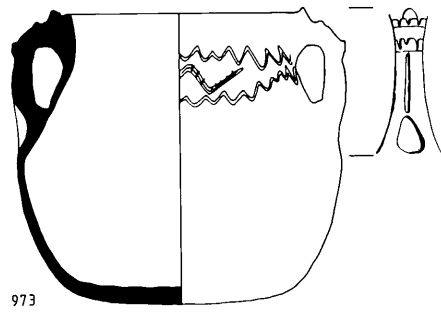
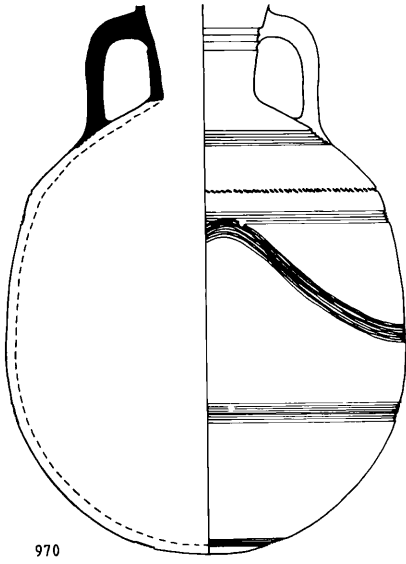
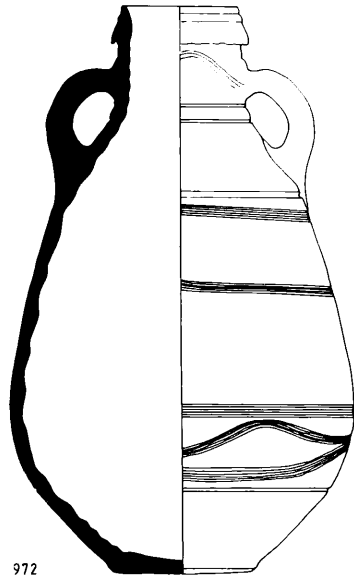
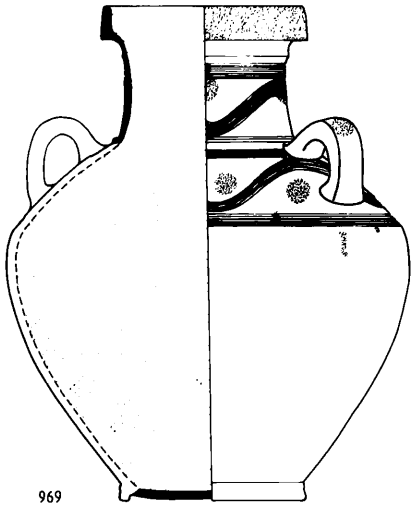
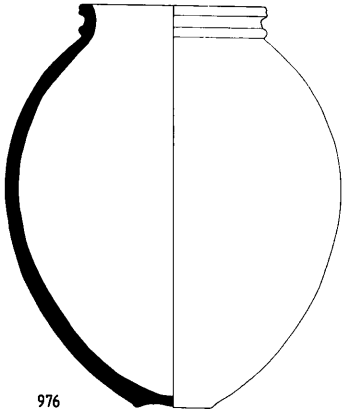

PLATE 85

JARS

Pot No	TR No	Batch	Level	Dimensions	Range	Ware and Remarks
976		A 307	A 2a-b	R: 27.0 cm H: 60.0 cm B: 11.0 cm		Ware: coarse buff. Temper: grit and chaff. Cracked in firing and mended with a coating of plaster. Pot 737 was found inside this jar. Almost complete.
977		DG 8b-66	D 2	R: 15.0 cm H: 49.5 cm B: 10.0 cm		Ware: coarse light buff. Temper: grit and chaff. Profile. Plate 17c
978	178	CG -64	C 3	R: 13.0 cm H: 46.2 cm B: 11.2 cm	A 2a	Ware: medium coarse buff with grey core. Temper: grit and chaff. Slip: red over all outside. Contained skeleton. Complete.
979		DG 8a-66	D 2	R: 10.2 cm H: 58.8 cm B: 14.2 cm		Ware: coarse grey. Temper: chaff. Profile. Plate 17b
980		DG 5-66	D 2	R: 15.0 cm H: 57.0 cm B: 4.2 cm	C 1-4	Ware: medium coarse light buff. Temper: chaff. Profile.
981		C 557	Mixed	D: 25.5 cm H: 47.8 cm B: 5.0 cm	C 1-2	Ware: medium coarse buff. Temper: grit and chaff. Rim: missing. Lower profile.
982		C 234 CG 10-68	C 1	R: 23.0 cm H: 62.0 cm	C1-2	Ware: coarse green-buff. Temper: grit and chaff. Contained child burial. Complete.
983		CG 2-71	C 3	R: 19.0 cm H: 55.0 cm	C 1	Ware: medium coarse green. Temper: grit and chaff. Base: broken in antiquity and replaced with bitumen, inside which were impressions of cloth. Neck of jar was stopped with a rimless deep bowl. Contained child burial. Almost complete.
984		C 237 CG 11-68	C 1	R: 22.0 cm H: 53.5 cm		Ware: medium coarse grey. Temper: grit and chaff. Contained child burial. Almost complete.
985	5051	C 442	C 6	R: 16.0 cm H: 53.5 cm	C 5-6	Ware: medium coarse red to white. Temper: white grit. Surface: coating of bitumen inside on rim and outside on upper and lower parts of jar. Decoration: single horizontal groove at shoulder. Almost complete.



976

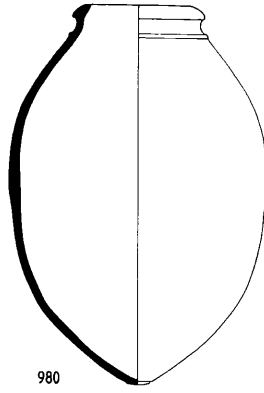

980

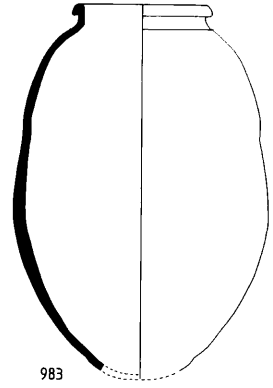

983

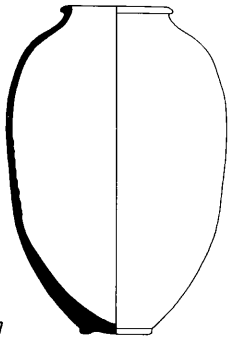

977

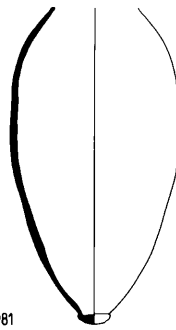

981

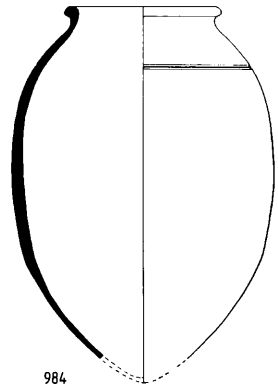

984

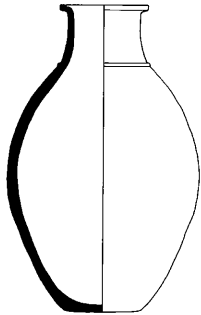

978

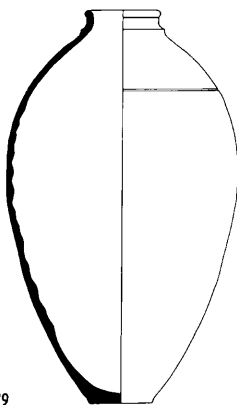

979

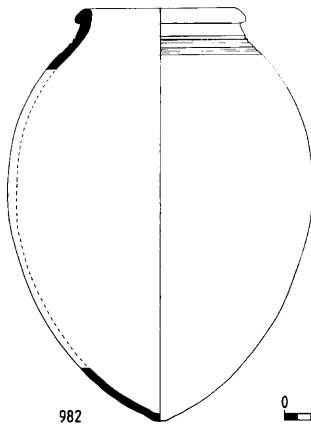

982

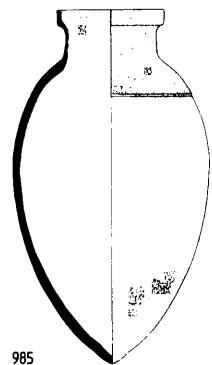

985

PLATE 86

JARS – MIDDLE ASSYRIAN AND MITANNI

Pot No	TR No	Batch	Level	Dimensions	Range	Ware and Remarks
986	2116	A 274	A 2	R: 11.8 cm H: 37.5 cm B: 14.0 cm	A 2 C 1	Ware: medium coarse light green. Temper: grit and chaff. Surface: irregular splashes of bitumen outside on lower part of jar. Almost complete.
987		A 352	A 2a-b	R: 10.0 cm H: 41.5 cm B: 11.0 cm		Ware: coarse buff. Temper: grit and chaff. Slip: plum red over all, including base. Profile.
988		A 352	A 2a-b	R: 13.0 cm H: 55.0 cm B: 11.5 cm	A 2	Ware: coarse light buff. Temper: grit and chaff. Profile.
989	154	A 20	A 2a-b	R: 13.0 cm H: 44.3 cm B: 10.3 cm		Ware: coarse light buff. Temper: grit and chaff. Almost complete.
990		C 670	C 5	R: 16.0 cm H: 49.0 cm B: 14.8 cm		Ware: medium coarse buff. Temper: grit and chaff. Profile.
991	6066	C 557	Mixed	R: 14.0 cm H: 51.5 cm B: 13.5 cm	C 5-6	Ware: medium coarse buff. Temper: large white grit and chaff. Surface: very well smoothed. Found with Pot 997. Complete. Plate 13
992	167	A 41	A 2a-b	R: 16.0 cm H: 49.5 cm B: 12.5 cm	A 2a	Ware: medium coarse buff. Temper: grit and chaff. Complete.
993		C 677	C 5	R: 14.5 cm H: 50.6 cm B: 13.8 cm		Ware: medium coarse buff. Temper: grit and chaff. Surface: thick coating of plaster outside. Profile.
994		C 542 CG 3-71	C 5b	R: 14.0 cm H: 36.2 cm		Ware: medium coarse buff. Temper: grit and chaff. Surface: smoothed outside. Base: removed in antiquity and replaced by a few bodysherds from different pots. Contained child burial. Almost complete.
995		C 517	C 3	R: 13.0 cm H: 43.0 cm	C 3	Ware: medium coarse buff. Temper: grit and some chaff. Base: missing. Upper profile.
996		C 749	C 4	R: 13.0 cm H: 47.0 cm		Ware: medium coarse pink to white. Temper: grit and chaff. Base: missing. Upper profile.
997	6067	C 557	Mixed	R: 14.0 cm H: 50.5 cm B: 10.5 cm	C 2-3	Ware: medium coarse green. Temper: large white grit and chaff. Rim: warped. Paint: bitumen wash used for two large designs on opposite sides of jar at same level. Found with Pot 991. Complete. Plate 13

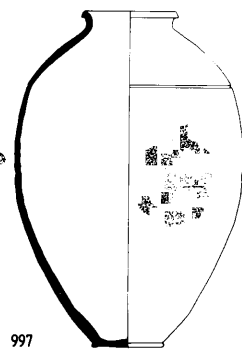
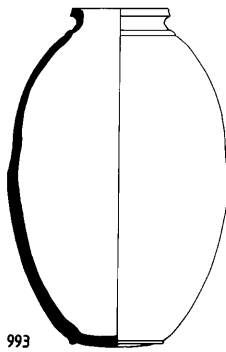
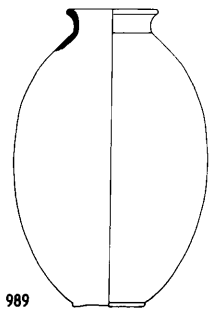
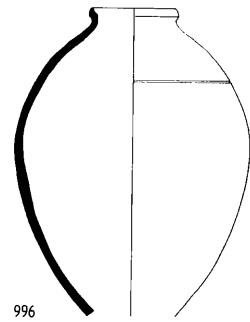
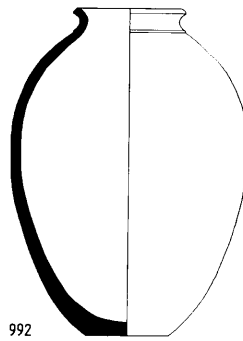
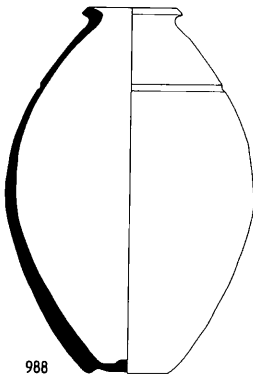
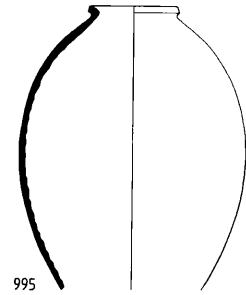
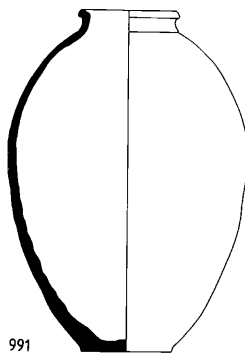
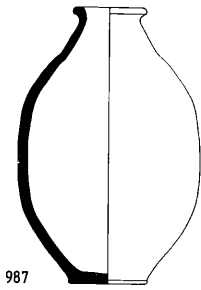
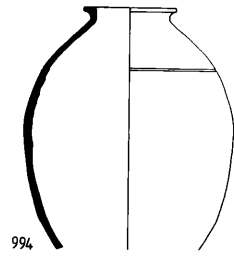
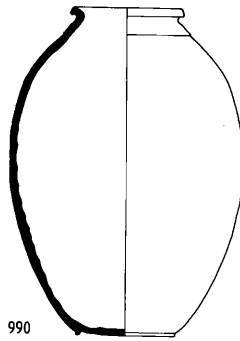
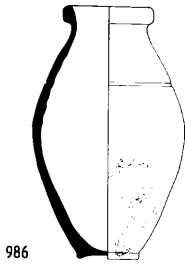
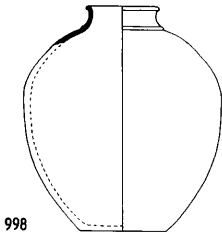

PLATE 87

JARS – MIDDLE ASSYRIAN TO OLD BABYLONIAN

Pot No	TR No	Batch	Level	Dimensions	Range	Ware and Remarks
998	155	A	A 1	R: 10.0 cm H: 33.5 cm B: 12.6 cm		Ware: coarse light green-buff. Temper: grit and chaff. Complete.
999		D 58	D 3	R: 14.6 cm H: 36.0 cm B: 14.5 cm	C 1	Ware: coarse red. Temper: chaff. Profile.
1000	6048	C 1011	C 5b	R: 11.0 cm H: 29.3 cm B: 11.0 cm	C 5	Ware: medium coarse buff. Temper: some large white grit and chaff. Paint: black to brown, or faded bitumen wash, irregularly applied in one horizontal band and six vertical stripes of uneven size. Complete.
1001		DG 22-66	D 4	R: 10.6 cm H: 38.8 cm B: 12.5 cm	C 5	Ware: coarse buff. Temper: grit and chaff. Complete.
1002		C 247	C 3	R: 10.6 cm H: 36.6 cm B: 11.0 cm	A 2a	Ware: medium fine pink to white. Temper: grit and chaff. Rim: two small grooves at one point. Decoration: incised rough cross-hatching as drawn and also on one other place on shoulder. Profile.
1003		D 65	D 4	R: 11.2 cm H: 33.4 cm B: 11.0 cm	A 2a C 3-4	Ware: medium coarse buff. Temper: chaff. Profile.
1004		C 944	C 4-5	R: 12.0 cm H: 36.8 cm B: 11.0 cm		Ware: medium coarse green. Temper: grit and chaff. Profile.
1005		C 749	C 4	R: 10.0 cm H: 35.6 cm B: 11.3 cm	C 6a-6	Ware: medium coarse buff. Temper: some large white grit and chaff. Warped. Profile.
1006		C 944	C 4-5	R: 10.0 cm H: 36.8 cm B: 11.0 cm		Ware: medium coarse red fired white in places. Temper: grit and chaff. Profile.
1007		C 524	C 4	R: 12.0 cm H: 33.0 cm B: 9.5 cm		Ware: medium coarse red-brown. Temper: grit and chaff. Profile.
1008		CG 15-71	C 5	R: 10.5 cm H: 32.7 cm B: 14.5 cm		Ware: medium coarse green. Temper: grit and chaff. Upper part of body of jar was broken in antiquity to admit burial of very small child. Profile.
1009		C 706 C 712 C 713	C 4	R: 19.0 cm H: 35.2 cm B: 11.0 cm		Ware: medium coarse red with buff core in places. Temper: grit and chaff. Profile.
1010		C 677	C 5	R: 16.5 cm H: 40.4 cm B: 13.0 cm		Ware: medium coarse green. Temper: grit and chaff. Profile.
1011		C 696	C 6a	R: 11.4 cm H: 30.4 cm B: 11.4 cm	C 6	Ware: medium coarse pink. Temper: some large white grit and chaff. Paint: bitumen wash in a narrow horizontal band round base of neck and random thin vertical stripes, three now extant. Profile.
1012		C 1000	C 6a	R: 12.5 cm H: 16.0 cm		Ware: medium coarse red. Temper: grit and much chaff. Two small holes (possible originally three) at base of neck. Base: low ring, not joining, of same type as Pot 1011. Rim sherd.



998

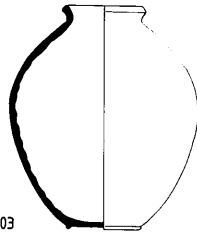

1003

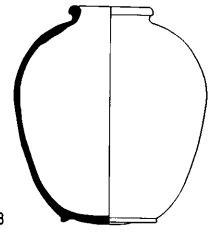

1008

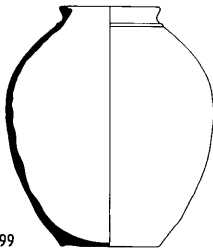

999

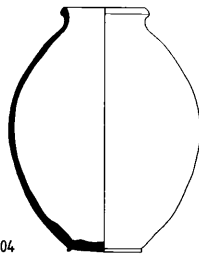

1004

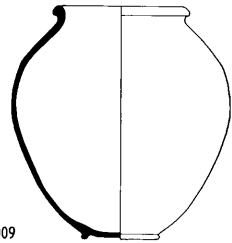

1009

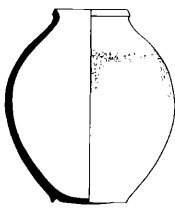

1000

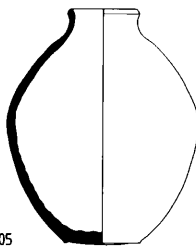

1005

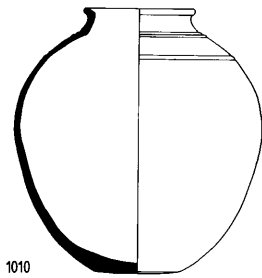

1010

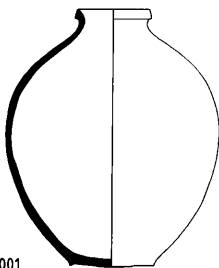

1001

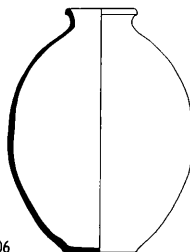

1006

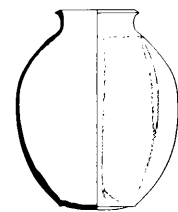

1011

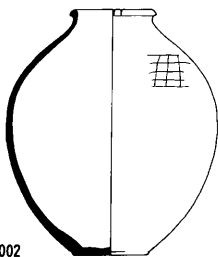

1002

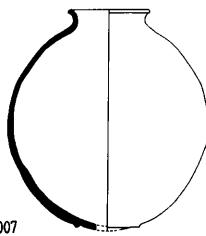

1007

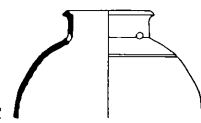

1012

PLATE 88

JARS – OLD BABYLONIAN

Pot No	TR No	Batch	Level	Dimensions	Range	Ware and Remarks
1013		A 463	A 3 late	R: 27.0 cm H: 50.0 cm B: 12.0 cm	C 5-6a	Ware: coarse red-buff. Temper: grit and chaff. Decoration: horizontal rib and grooves. Profile.
1014		C 384	C 5b	R: 27.0 cm H: 38.0 cm	C 6a	Ware: medium coarse pink-buff with grey core. Temper: grit and chaff. Surface: plaster coating in. Decoration: roughly incised pattern of four vertical strokes, repeated elsewhere on the jar. Base: missing. Profile.
1015		A 556	A 3	R: 24.5 cm H: 37.0 cm		Ware: coarse light buff. Temper: grit and chaff. Surface: coating of bitumen and plaster outside. Decoration: horizontal rib with multiple grooves below and between them an incised palm-tree design on shoulder of jar H: 7.7 cm, W: 3.6 cm. Base: missing. Upper profile.
1016		CG 16-71	C 5b	R: 25.5 cm H: 41.0 cm	C 5	Ware: medium coarse green. Temper: grit and chaff. Base: missing. Decoration: single horizontal rib. Three-quarters of body of jar removed in antiquity to admit child burial. Upper profile.
1017		A 605	A 4	R: 22.0 cm H: 29.5 cm		Ware: coarse salmon-pink. Temper: grit and some chaff. Decoration: horizontal multiple grooves. Base: missing. Upper profile.
1018		C 442	C 6	R: 15.0 cm H: 44.0 cm B: 13.0 cm		Ware: coarse pink to green. Temper: grit and chaff. Decoration: two horizontal grooves. Profile.
1019	6068	CG 17-71	C 5b	R: 22.0 cm H: 39.4 cm B: 14.0 cm	C 6	Ware: medium coarse pink. Temper: grit and chaff. Surface: traces of bitumen and plaster on base inside and out. Decoration: single horizontal rib with double groove below. Child burial. Complete.
1020		A 565	A 3	R: 26.0 cm H: 46.8 cm B: 14.3 cm	C 5-6a	Ware: coarse buff to grey. Temper: grit and chaff. Decoration: single horizontal rib with spiral groove below. Profile.
1021	6040	C 686	C 6a	R: 25.0 cm H: 45.3 cm B: 17.0 cm		Ware: medium coarse green, very overfired and warped. Temper: some large white grit and chaff. Decoration: double horizontal rib with multiple grooves below. Pot M <i>Figure 11</i> . Complete.
1022		C 686	C 6a	R: 20.0 cm H: 44.2 cm B: 14.5 cm	C 5-6a	Ware: medium coarse buff, warped in places. Temper: many large white grits and chaff. Decoration: horizontal rib and groove with multiple grooves below. Profile.
1023	3120	A 427	A 2c	R: 20.6 cm H: 43.0 cm B: 17.8 cm		Ware: coarse light buff. Temper: grit and chaff. Decoration: single horizontal rib with double groove below. Profile.
1024		A 463	A 3 late	R: 20.0 cm H: 43.2 cm B: 13.6 cm	C 6a	Ware: coarse buff. Temper: grit and chaff. Decoration: single horizontal rib with multiple grooves below. Profile.
1025	6039	C 686	C 6a/6	R: 18.0 cm H: 46.5 cm B: 15.0 cm	C 6a	Ware: medium coarse green, very warped. Temper: some large white grit and chaff. Decoration: single rib with groove below. Pot A <i>Figure 11</i> . Contained 412, 438, 519, 814, 816, 817. Complete.
1026		A 641	A 3	R: 15.0 cm H: 29.5 cm B: 9.0 cm		Ware: coarse buff, unevenly made. Temper: grit and some chaff. Surface: light coating of bitumen inside. Profile.
1027		C 937	C 4	R: 11.5 cm H: 27.5 cm B: 9.8 cm		Ware: medium coarse red. Temper: grit and chaff. Surface: well smoothed outside. Handle: remains of one handle, overlapping rim to ca. 5 cm inside. Base: very lopsided. Profile.
1028	6037	C 686	C 6a	R: 11.0 cm H: 29.3 cm B: 10.0 cm	C 6a	Ware: medium coarse red fired pink to white in places. Temper: some large white grits and chaff. Decoration: single horizontal groove. Pot L <i>Figure 11</i> . Almost complete.
1029		C 673 C 674 C 679	C 6a	R: 12.0 cm H: 33.2 cm B: 9.0 cm	C 6a	Ware: medium coarse red-buff. Temper: some large white grit and chaff. Decoration: triple horizontal groove. Base: broken. Profile.
1030	6038	C 696	C 6a	R: 11.0 cm H: 31.4 cm B: 9.3 cm	C 6a-6	Ware: medium coarse dark buff fired red to white in places. Temper: some large white grit and chaff. Decoration: single horizontal groove. Complete.
1031		C 686	C 6a	R: 12.0 cm H: 34.2 cm B: 10.5 cm	C 6a-6	Ware: medium coarse dark buff to cream. Temper: many large white grits and chaff. Decoration: single horizontal groove. Pot Z <i>Figure 11</i> . Profile.
1032		A 419	A 3	R: 14.0 cm H: 22.0 cm B: 8.0 cm		Ware: medium coarse red. Temper: grit and some chaff. Decoration: single horizontal groove. Rim: missing. Lower profile.

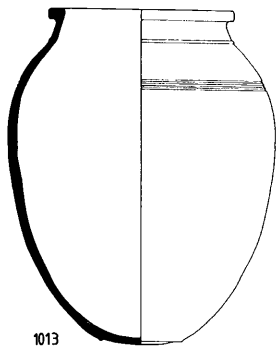

1013

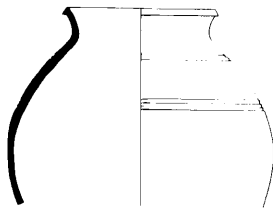

1017

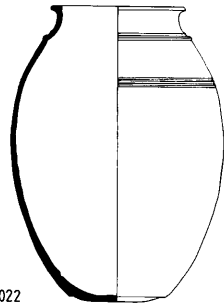

1022

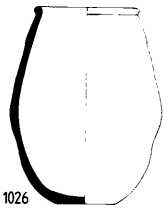

1026

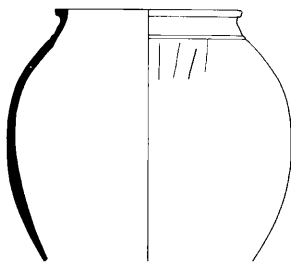

1014

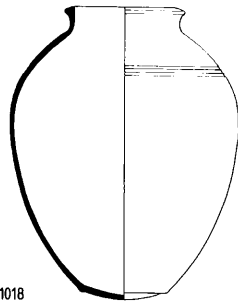

1018

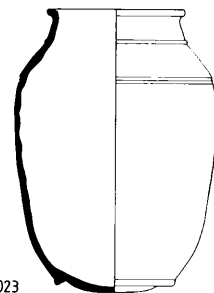

1023

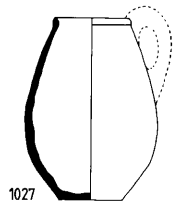

1027

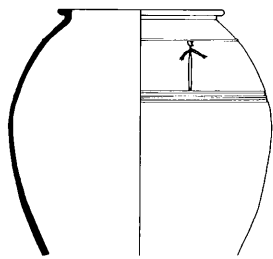

1015

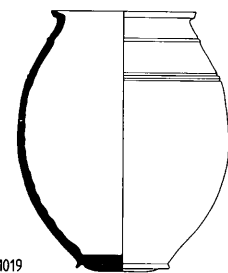

1019

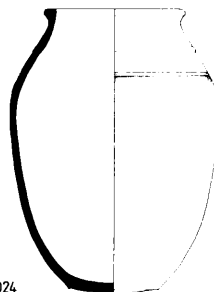

1024

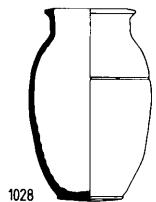

1028

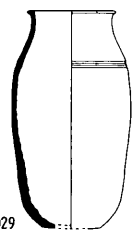

1029

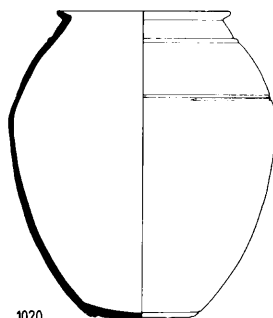

1020

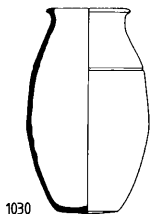

1030

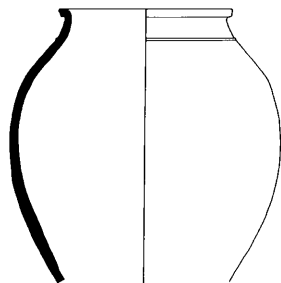

1016

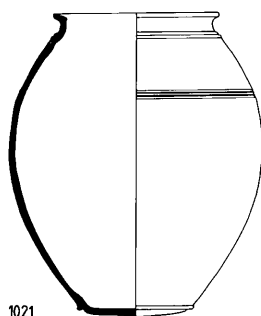

1021

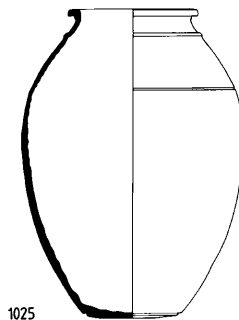

1025

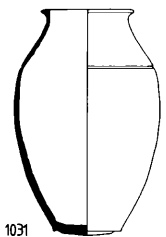

1031



1032

PLATE 89

LARGE JARS – OLD BABYLONIAN

Pot No	TR No	Batch	Level	Dimensions	Range	Ware and Remarks
1033		C	C 2-3	R: 27.0 cm H: 65.5 cm B: 14.0 cm	A 2-3 C 4-5	Ware: coarse buff. Temper: grit and chaff. Surface: traces of original coating of plaster over outside of jar, up to 0.5 cm thick. Decoration: single horizontal raised cable with rough incised design below. Profile.
1034		A 463	A 3 late	R: 36.5 cm H: 56.0 cm	A 2a	Ware: coarse buff. Temper: grit and chaff. Surface: coating of bitumen outside. Decoration: single horizontal rib and multiple grooves below. Profile.
1035		A 452	A 3	R: 37.0 cm H: 55.5 cm B: 15.0 cm	C 5-5b	Ware: coarse buff. Temper: grit and chaff. Decoration: horizontal double rib with two raised cables below. Profile.
1036	5055 + 5710	C 33	C 6	R: 41.0 cm H: 74.5 cm B: 14.5 cm		Ware: coarse brown-buff. Temper: white grit and chaff. Surface: thin coating of plaster inside. Decoration: single broad rib, a small incised checker-board pattern and on opposite side of jar a cuneiform inscription (TR 5710):- 1 ANŠE 5 sutu 1/3 QA 1 Homer 5 sutu 1/3 QA i-na GiŠ.BAN.DINGIR.UTU according to the measure of Shamash The capacity of the jar is 121.3 litres. Almost complete. Plate 24b
1037		A 573	A 3	R: 38.0 cm H: 84.0 cm B: 36.0 cm	C 6	Ware: coarse yellow-buff. Temper: grit and chaff. Decoration: six horizontal raised cables. Profile.
1038		C 438	C 6	R: 40.0 cm H: 51.0 cm	C 6	Ware: coarse buff fired pink to green in places. Temper: mainly grit with some chaff. Decoration: horizontal broad ribs with a row of crescent-shaped incisions in between. Base: missing. Upper profile.
1039		A 409 A 411 A 412 A 413	A 3	R: 33.0 cm H: 59.6 cm B: 24.5 cm		Ware: coarse buff. Temper: grit and chaff. Decoration: multiple horizontal grooves at base of neck, raised cable rib on shoulder and single groove at base. Profile.
1040		A 615	A 3	R: 27.0 cm H: 60.0 cm B: 29.0 cm	A 3-4	Ware: coarse buff. Temper: grit and chaff. Decoration: single cable rib on shoulder and three grooves on top of ledge rim. Profile.
1041		A 604	A 4	R: 30.5 cm H: 49.0 cm B: 10.5 cm	A 3 C 6	Ware: coarse buff. Temper: grit and chaff. Surface: thin coating of plaster inside. Decoration: single horizontal grooves with incised wavy line between. Base: double groove and hole in centre D: 1.2 cm. Profile.

PLATE 90

JARS – KHABUR WARE

Pot No	TR No	Batch	Level	Dimensions	Range	Ware and Remarks
1042		C 395	C 6	R: 12.0 cm H: 35.0 cm B: 10.7 cm		Ware: medium fine buff. Warped. Temper: grit. Slip: cream, only above carination outside, over rim and inside to base of neck. Paint: dark brown. Profile.
1043		C 395	C 6	R: 12.5 cm H: 31.5 cm B: 12.2 cm	C 6	Ware: medium fine salmon-pink. Temper: grit. Slip: none. Paint: dark red. Profile.
1044		C 78	C 6	R: 12.5 cm H: 23.0 cm	C 6	Ware: medium fine salmon-pink. Temper: grit and chaff. Slip: cream outside. Paint: dark red. Base: missing. Upper profile.
1045		C 395	C 6	R: 13.0 cm H: 15.0 cm	C 5-6	Ware: medium fine buff. Temper: grit. Slip: none. Paint: red. Base: missing. Upper profile.
1046		C 395 C 440	C 6	D: 28.5 cm H: 26.8 cm B: 11.5 cm		Ware: medium fine red. Temper: grit. Slip: cream outside. Paint: dark red with splashes inside and below pattern outside. Rim: missing. Lower profile.
1047		C 395	C 6	D: 31.6 cm H: 29.4 cm B: 11.7 cm		Ware: medium fine orange-red. Temper: grit and chaff. Slip: cream outside. Paint: red-brown. Rim: missing. Lower profile.
1048		A 554 A 555	A 3	D: 24.0 cm H: 24.0 cm B: 11.0 cm		Ware: medium fine pink-buff. Temper: grit and chaff. Slip: white outside. Paint: faded dark red. Rim: missing. Lower profile.
1049		C 395	C 6	R: 13.0 cm H: 35.8 cm B: 15.0 cm	A 3 C 2-6	Ware: medium fine red. Temper: grit and chaff. Paint: red. Pattern: narrow horizontal bands with a small cross design at one point on shoulder, only half preserved. Profile.
1050		C 395	C 6	D: 32.0 cm H: 26.0 cm B: 15.0 cm		Ware: medium fine pink-buff. Temper: grit. Paint: dark brown. Rim: missing. Lower profile.
1051		A 631	A 4	R: 13.2 cm H: 22.0 cm	A 2c-4 C 5	Ware: medium fine cream. Temper: grit. Paint: black. Base: missing. Upper profile.
1052		C 561	C 7	R: 13.5 cm H: 20.7 cm		Ware: medium fine orange. Temper: grit. Decoration: incised horizontal multiple grooves of the same pattern as the painted types. Base: low ring (not joining). Upper profile.

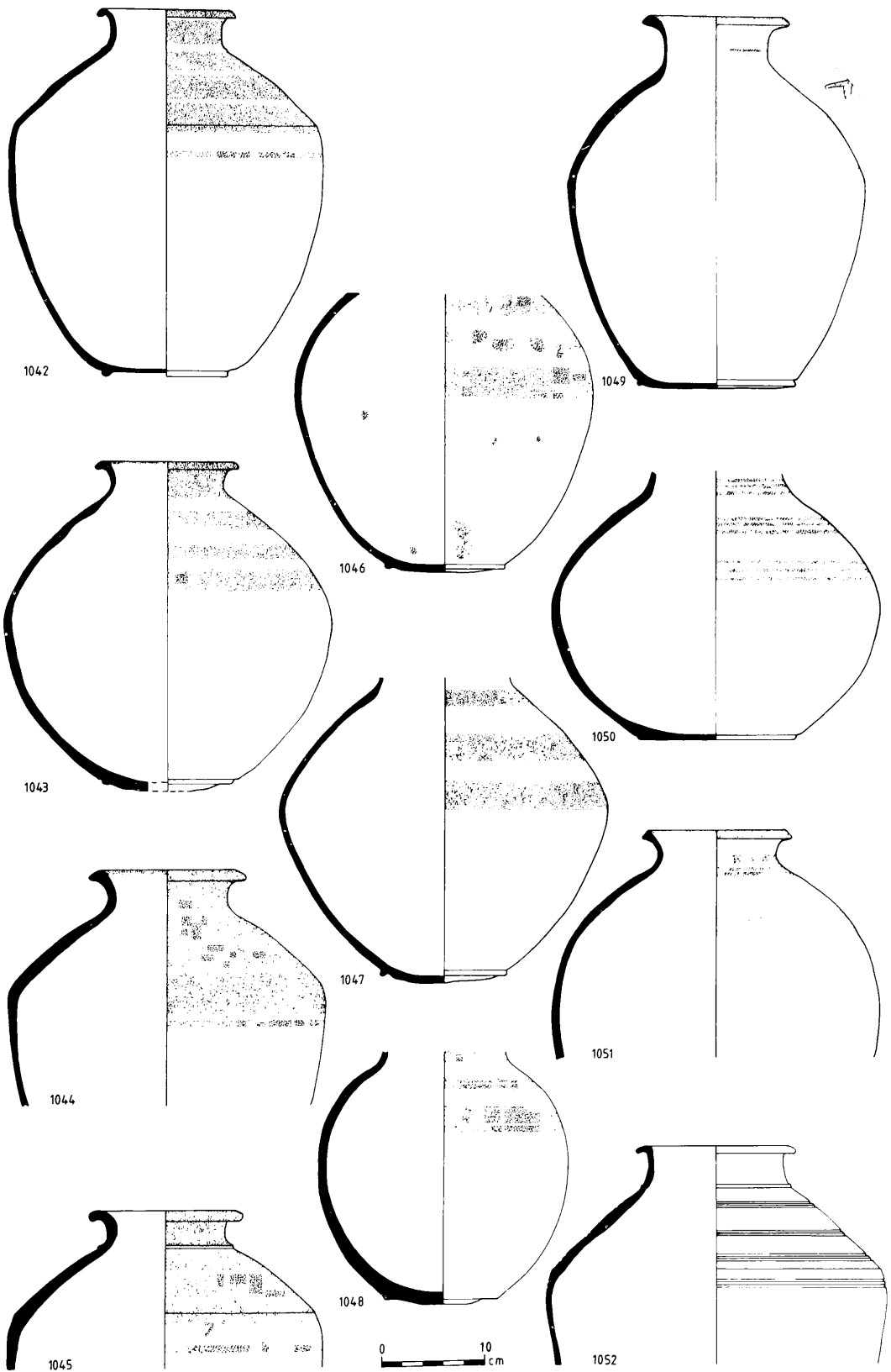

PLATE 9

NUZI AND KHABUR WARE JARS AND BOWLS

Pot No	Tl No	Batch	Level	Dimensions	Range	Ware and Remarks
1053		A 473 A 487	A 1	R: 20.0 cm H: 26.0 cm	A 1	Ware: medium pink-buff. Temper: white grit and much chaff. Paint: red. Handle: vertical strap with red stripe continuing vertically down jar. One handle only on sherd. Base: missing. Upper profile.
1054		A 15	A 1-2	R: 25.0 cm H: 19.7 cm	A 1	Ware: medium coarse buff. Temper: grit and chaff. Surface: smoothed. Paint: red with strokes on rim and chevrons on handles. Handles: two vertical strap. Base: missing. Upper profile.
1055	3124	A 487	A 1	R: 21.0 cm H: 14.6 cm		Ware: medium coarse buff. Temper: grit and chaff. Paint: red-brown birds with overpainted white dots along outline. Broad band below overpainted in white. Rim: painted plain red. Base: missing. Rim sherd.
1056	4106	A 25	A 2c	R: 28.0 cm H: 13.0 cm	A 2a-3 C 5	Ware: medium coarse buff. Temper: grit. Paint: red. Rim sherd. Plate 23a
1057		C 48 C 77	C 5	R: 15.2 cm H: 13.8 cm	C 4-5	Ware: medium fine brown-buff. Temper: grit and chaff. Paint: black with zig-zags on rim. Base: missing. Rim sherd.
1058		C 38	C 6a	D: 17.0 cm H: 13.0 cm	A 3 C 5	Ware: medium fine brown-buff. Temper: white grit. Paint: orange-red with splashes inside. Rim: missing. Base: missing. Bodysherd.
1059		A 555 A 565	A 3	D: 18.0 cm H: 11.9 cm	A 3	Ware: medium fine green. Temper: grit. Paint: red. Rim: missing. Base: missing. Bodysherd.
1060		A 473	A 1	D: 31.5 cm H: 23.6 cm		Ware: medium coarse red. Temper: grit and chaff. Paint: red bands with designs overpainted in white. Rim: missing. Base: missing. Bodysherd.
1061		A 599	A 3	R: 25.5 cm H: 22.7 cm B: 15.0 cm	C 4	Ware: medium fine buff. Temper: grit and some chaff. Paint: faded brown. Profile.
1062		A 406 A 408 A 411	A 2c-3	R: 26.4 cm H: 6.4 cm		Ware: medium coarse buff. Temper: grit and chaff. Paint: red. Base: missing. Rim sherd. Plate 19a
1063		A 480	A 3	R: 33.2 cm H: 10.5 cm	A 3	Ware: medium coarse buff. Temper: grit and chaff. Paint: very faded red with splashes in. Base: missing. Rim sherd.
1064	5009	A 630	A 4	H: 31.0 cm B: 11.0 cm	A 2c	Ware: medium coarse pink-buff. Temper: grit and chaff. Paint: fugitive bright red to orange. Rim: missing. Lower profile.

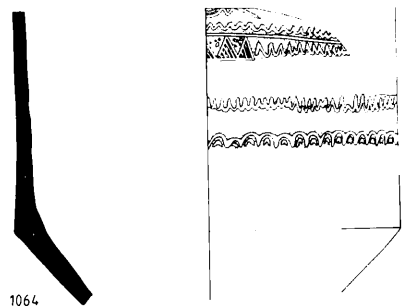
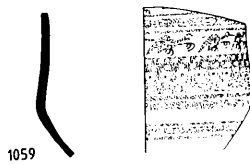
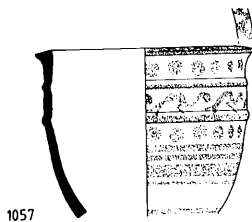
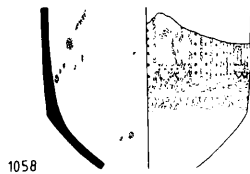
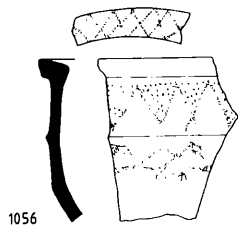
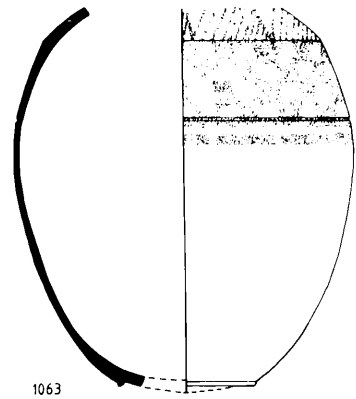
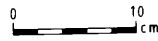
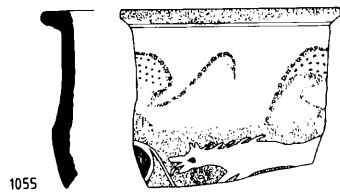
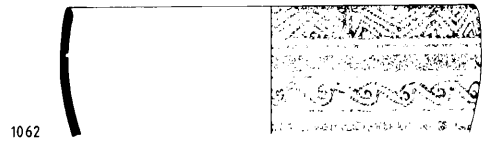
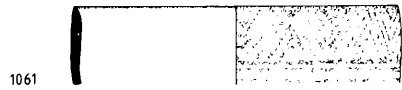
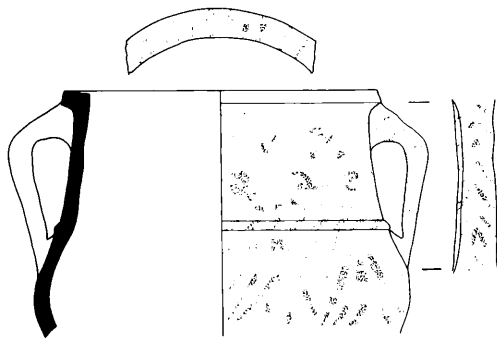
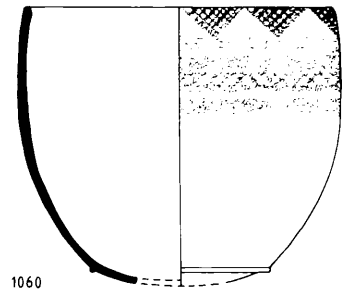
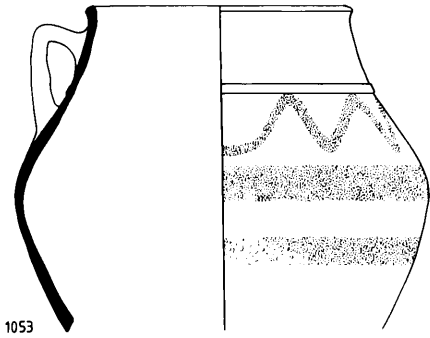

PLATE 92

Pot No	TR No	Batch	Level	Dimensions	Range
1065	3115		Surface	R: 6.2 cm H: 3.0 cm	A 1
Ware: Very coarse green. Temper: chaff. Handmade. Complete					
1066		A 228	A 1b	R: 10.8 cm H: 3.8 cm	
Ware: coarse cream. Temper: chaff. rough, handmade. Profile.					
1067		A 228	A 1b	R: 13.2 cm H: 4.5 cm	
Ware: coarse cream. Temper: chaff. Rough, handmade. Profile.					
1068	180	A	A 2	R: 10.4 cm H: 5.6 cm	
Ware: Coarse light green. Temper: grit and chaff. Complete.					
1069	2111	C	C 3	R: 11.4 cm H: 7.9 cm	
Ware: coarse green. Temper: grit, chaff. Handmade. Complete.					
1070		A 70	A LA	R: 12.2 cm H: 7.7 cm	
Ware: coarse brown. Temper: white grit. Almost complete.					
1071		A 42	A 1	R: 9.6 cm H: 7.0 cm	A 2b C 2-3
Ware: coarse green-buff. Temper: grit and chaff. Profile.					
1072		C 520	C 3	R: 8.6 cm H: 5.7 cm	
Ware: coarse green. Temper: chaff. Rough, uneven. Profile.					
1073		A 55	A 2b	R: 9.0 cm H: 5.3 cm	
Ware: medium buff. Temper: grit. Profile.					
1074		A 499	Mixed	R: 14.0 cm H: 15.5 cm	C 4
Ware: medium buff. Temper: grit and chaff. Smooth. Rim missing.					
1075	3116	A 455	A 2	R: 10.4 cm H: 6.1 cm	
Ware: coarse buff. Temper: chaff. Rough. Handmade. Complete.					
1076	2112	C	C 3	R: 8.0 cm H: 5.2 cm	A 1 C 3
Ware: coarse green. Temper: grit, chaff. Handmade. Complete.					
1077	152	C	C 3	R: 9.4 cm H: 4.7 cm	A 1-4
Ware: coarse green. Temper: chaff. Rough surface. Complete.					
1078	3118	A	Topsoil	R: 12.0 cm H: 5.4 cm	
Ware: medium buff. Temper: grit, chaff. Smoothed. Complete.					
1079	182	A 55	A 2b	R: 11.0 cm H: 6.8 cm	
Ware: coarse green. Temper: grit, chaff. Uneven. Complete.					
1080	179	A	A 2	R: 10.0 cm H: 6.1 cm	
Ware: coarse green. Temper: grit, chaff. Uneven. Complete.					
1081	6016	C 728	C 4-5	R: 4.8 cm H: 6.1 cm	C 6
Ware: coarse red. Temper: grit, chaff. Handmade. Complete.					
1082	185	A 58	A 2-3	R: 8.8 cm H: 5.0 cm	
Ware: coarse green. Temper: grit, chaff. Handmade. Complete.					
1083		C 734	C 5	D: 10.4 cm H: 5.8 cm	A 3
Ware: coarse green. Temper: grit, chaff. Solid knob, ? lid.					
1084		A 584	A 3	R: 13.4 cm H: 3.9 cm	A 4
Ware: medium buff. Temper: grit, chaff. Profile.					

STRAINERS

Pot No	TR No	Batch	Level	Dimensions	Range
1085		C 946	C 6a	R: 11.6 cm H: 4.3 cm	C 6a
Ware: medium buff. Temper: grit, chaff. Very rough. Profile.					
1086		D 62	D 3	R: 12.6 cm H: 6.2 cm	A Tops C 4
Ware: coarse green. Temper: grit, chaff. Rough. Profile.					
1087		C 569	C 5	R: 12.4 cm H: 6.0 cm	A 1-2a C 1-2
Ware: coarse red. Temper: grit, chaff. Roughly made. Profile.					
1088		A 587	A 3	R: 14.2 cm H: 6.0 cm	C 4
Ware: medium brown overfired. Temper: grit, chaff. Profile.					
1089		A 482	A 3	R: 11.6 cm H: 5.8 cm	A 1-3 C 6a
Ware: coarse light buff. Temper: grit. Profile.					
1090	3117	A 463	A 3 late	R: 12.2 cm H: 6.0 cm	A 1-3 C 6a
Ware: fine cream. Temper: grit and chaff. Complete.					
1091		A 6	A 2b	R: 9.8 cm H: 5.5 cm	A 1 C 2
Ware: fine cream. Temper: grit and chaff. Complete.					
1092	6015	C 539 C 569	C 5	D: 21.5 cm H: 27.3 cm	
Ware: medium green. Temper: grit and chaff. Rim missing.					
1093		A 565	A 3	R: 11.6 cm H: 4.5 cm	A 2a-3 C 6a
Ware: medium green. Temper: grit, chaff. Oval shape. Profile.					
1094		C 317	C 5	R: 11.6 cm H: 4.5 cm	A 2a-3 C 6a
Ware: medium buff. Temper: grit and chaff. Profile.					
1095		C 1017	C 6a	R: 13.0 cm H: 4.1 cm	A 2-3 C 6a
Ware: medium green. Temper: grit, chaff. Rough in. Profile.					
1096	6024	C 686	C 6a	R: 13.2 cm H: 5.6 cm	A 3 C 5
Ware: medium red. Temper: grit, chaff. Well made. Complete.					
1097		C 951	C 6	R: 14.6 cm H: 5.0 cm	A 3b-5 C 5-6
Ware: medium green. Temper: grit, chaff. Cut base. Profile.					
1098		A 701	A 4	R: 13.4 cm H: 5.0 cm	A 3-5 C 5-6
Ware: medium buff. Temper: grit, chaff. Base missing. Profile.					
1099		A 727	A 6	R: 14.8 cm H: 5.3 cm	A 5
Ware: medium fine green. Temper: grit, chaff. Profile.					
1100		A 675	A 4	R: 13.2 cm H: 6.1 cm	A 3-4
Ware: medium buff. Temper: grit, chaff. Rough. Profile.					
1101		A 702	A 5	R: 9.6 cm H: 3.9 cm	
Ware: grey. Temper: grit, chaff. 2 holes. Handmade. Profile.					
1102		A 480	A 3	R: 11.8 cm H: 4.9 cm	C 6
Ware: coarse buff. Temper: grit and much chaff. Profile.					
1103	5054	A 610	A 4	R: 5.5 cm H: 2.3 cm	C 6a
Ware: medium buff. Temper: white grit. Well made. Complete.					
1104		A 671	A 4	R: 12.8 cm H: 6.0 cm	A 3-4 C 6
Ware: coarse buff. Temper: grit, chaff. Profile.					

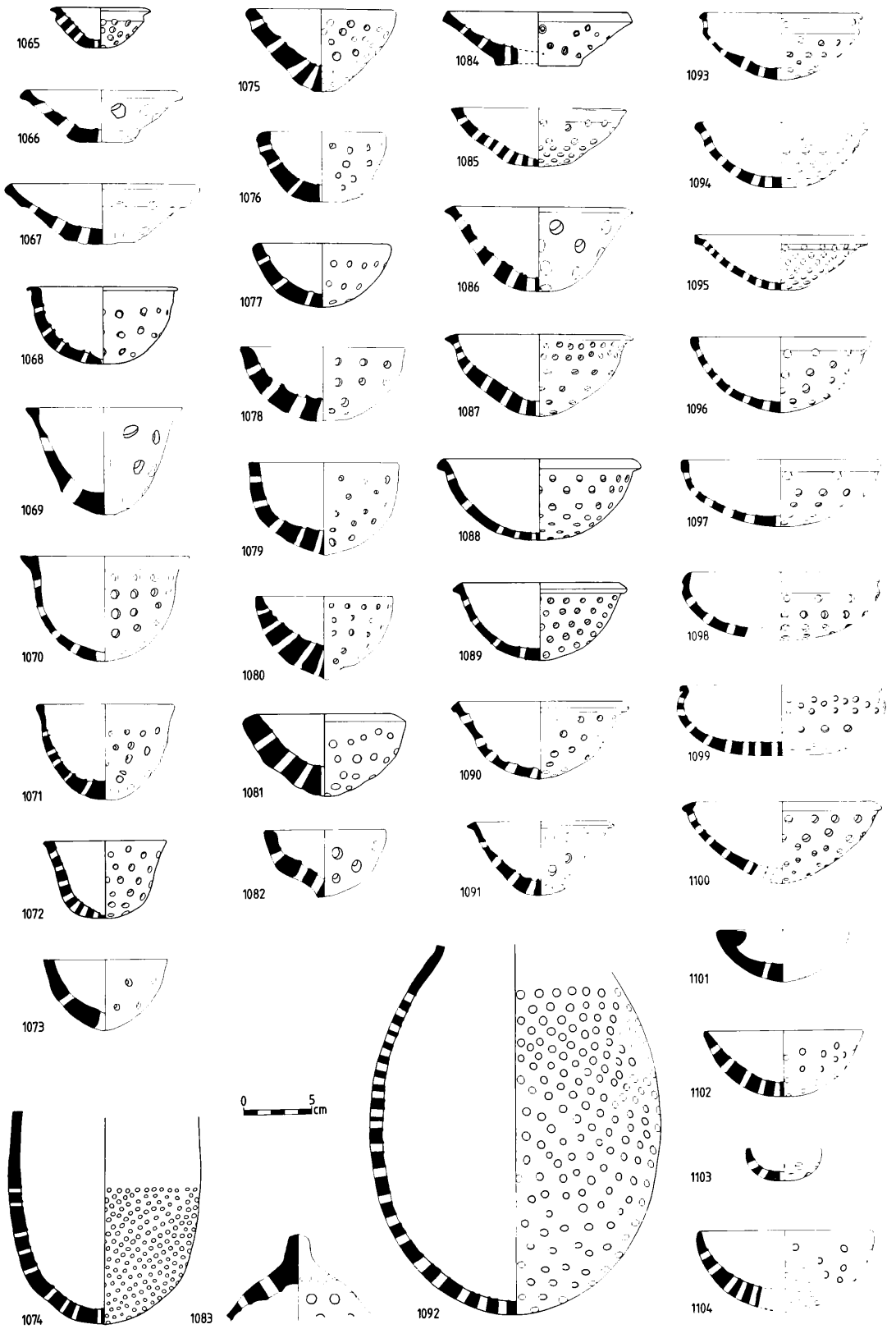

PLATE 93

POTSTANDS – MITANNI

Pot No	TR No	Batch	Level	Dimensions	Range	Ware and Remarks
1105	6060	C 677	C 5	R: 15.5 cm H: 12.9 cm B: 14.6 cm	C 5	Ware: medium coarse red. Temper: grit and chaff. Base: pronounced and very uneven pie-crust. Complete.
1106		C 688	C 5	R: 11.0 cm H: 11.2 cm B: 13.4 cm	C 4-5	Ware: medium coarse red. Temper: grit and chaff. Base: small and even pie-crust. Profile.
1107		C 677	C 5	R: 14.0 cm H: 14.0 cm B: 13.0 cm		Ware: medium coarse red-buff. Temper: grit and chaff. Base: uneven pie-crust. Profile.
1108		C 688	C 5	R: 15.0 cm H: 13.5 cm B: 13.6 cm	C 5-5b	Ware: coarse buff. Temper: grit and chaff. Base: thick, coarse, fairly even pie-crust. Profile.
1109		C 677 C 688	C 5	R: 15.0 cm H: 13.8 cm B: 13.0 cm	C 4-5	Ware: medium coarse buff. Temper: some large white grit and chaff. Rim: painted with bitumen wash. Base: pronounced and uneven pie-crust. Profile.
1110		C 524	C 5	R: 10.0 cm H: 11.0 cm B: 15.0 cm		Ware: medium coarse buff. Temper: grit and chaff. Base: even pie-crust. Profile.
1111		A 311	A 2c	R: 11.5 cm H: 11.0 cm B: 10.9 cm	A 2 C 4-5b	Ware: medium coarse cream. Temper: grit and chaff. Rim: painted with bitumen wash. Base: low and even pie-crust. Profile.
1112	4122	C	Topsoil	R: 10.4 cm H: 14.4 cm B: 12.0 cm	C 4	Ware: medium coarse buff. Temper: grit and chaff. Base: very slight pie-crust. Profile.
1113		C 55	C 4	R: 10.0 cm H: 14.0 cm B: 13.2 cm	C 4-5	Ware: medium coarse red. Temper: fine grit and chaff. Base: fine and even pie-crust. Complete.
1114	2131	C	C 2-3	R: 15.0 cm H: 17.5 cm B: 14.5 cm	C 4-5b	Ware: medium coarse red. Temper: grit and chaff. Base: fine and even pie-crust. Profile.
1115		C 953	C 5	R: 13.4 cm H: 12.2 cm B: 12.0 cm	A 3 C 4-5	Ware: medium coarse red. Temper: grit and chaff. Base: pronounced and even pie-crust. Complete.
1116	3126	A 461	A 1	R: 14.4 cm H: 12.0 cm B: 14.0 cm		Ware: medium coarse light green. Temper: chaff. Base: low and even pie-crust. Complete.
1117		A 570	A 2c	R: 15.5 cm H: 15.0 cm B: 15.0 cm	C 4-5b	Ware: medium coarse red. Temper: grit and chaff. Rim: painted with bitumen wash. Base: low and fairly even pie-crust. Profile.
1118	3133	A 490	A 2a	R: 16.0 cm H: 16.0 cm B: 15.6 cm	A 3 C 4-5	Ware: medium coarse light green. Temper: chaff. Rim: traces of bitumen wash. Base: very slight pie-crust. Complete.
1119		A 657	A 4-5	R: 14.0 cm H: 13.5 cm B: 17.5 cm	C 5b	Ware: medium coarse salmon-pink. Temper: grit and chaff. Base: even pie-crust. Profile.

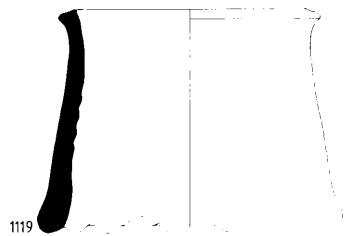
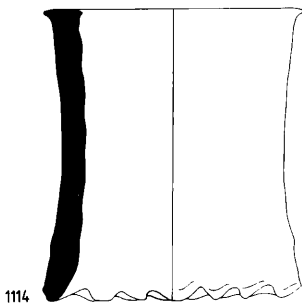
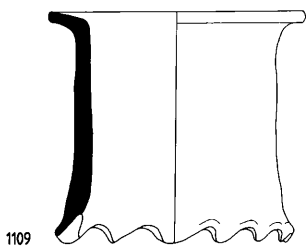
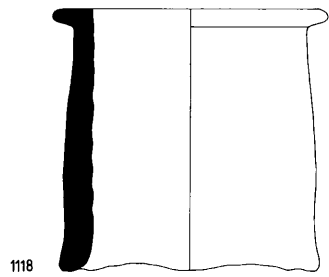
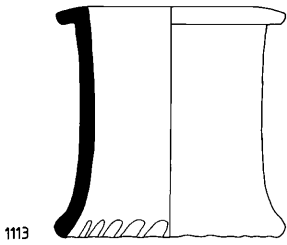
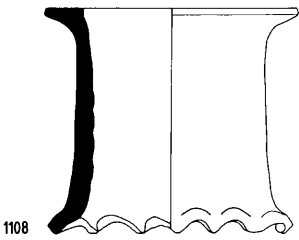
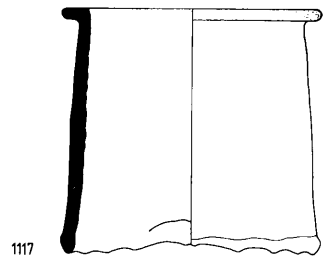
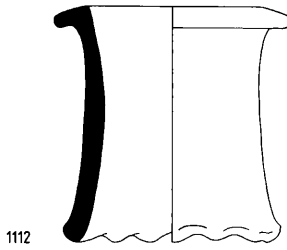
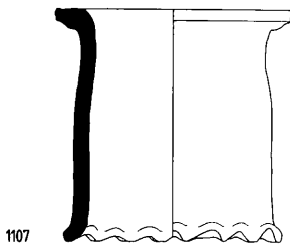
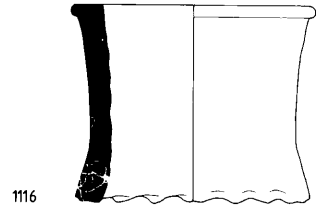
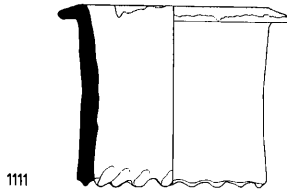
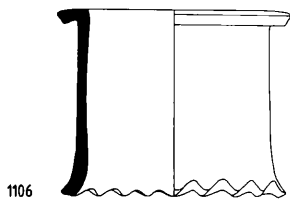
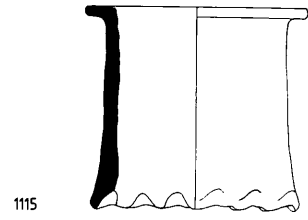
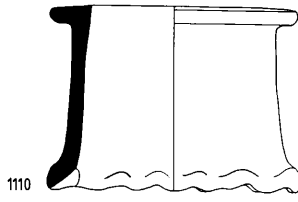
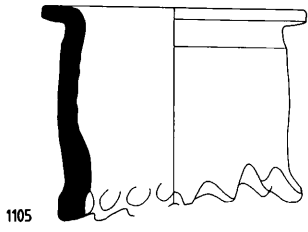

PLATE 94

POTSTANDS – MITANNI

Pot No	TR No	Batch	Level	Dimensions	Range	Ware and Remarks
1120	3132	D	D 4	R: 11.8 cm H: 13.1 cm B: 14.0 cm		Ware: medium fine red-buff. Temper: large white grit and fine chaff. Base: neat and even pie-crust. Complete.
1121	3128	D	D 4	R: 14.0 cm H: 12.2 cm B: 13.0 cm	C 4-5	Ware: coarse green. Temper: chaff. Base: slight and uneven pie-crust. Complete.
1122	3131	D	D 4	R: 12.0 cm H: 14.5 cm B: 13.5 cm	C 4-5	Ware: medium coarse buff. Temper: grit and chaff. Base: very slight pie-crust. Complete.
1123	3129	D	D 4	R: 11.5 cm H: 12.3 cm B: 12.5 cm	A 2 C 5-5b	Ware: medium coarse red to green. Temper: grit and chaff. Base: slight and uneven pie-crust. Complete.
1124	3125	D	D 4	R: 11.0 cm H: 13.4 cm B: 11.3 cm	C 4	Ware: medium coarse light buff. Temper: grit and chaff. Base: very slight pie-crust. Complete.
1125		C 676	C 5b	R: 12.0 cm H: 12.8 cm B: 11.4 cm	C 5b	Ware: medium coarse buff. Temper: grit and chaff. Base: almost non-existent pie-crust. Profile.
1126		C 676	C 5b	R: 12.0 cm H: 14.2 cm B: 12.5 cm	C 4	Ware: medium coarse red-brown. Temper: grit and chaff. Rim: painted with bitumen wash with traces of bitumen on base. Base: widely spaced thumb-impressions forming pie-crust. Profile.
1127	3127	A 465	A 3	R: 12.4 cm H: 14.5 cm B: 13.0 cm	C 4-5b	Ware: medium coarse light green. Temper: grit and chaff. Base: widely spaced thumb-impressions forming pie-crust. Complete.
1128	6065	C 676	C 5b	R: 12.4 cm H: 14.2 cm B: 14.8 cm		Ware: medium coarse red. Temper: grit and chaff. Base: only four thumb-impressions, creating a rectangular base. Almost complete.
1129	4111	A 565	A 3	R: 14.4 cm H: 13.5 cm B: 14.4 cm	A 3-5 C 4-5	Ware: medium coarse light buff. Temper: grit and chaff. Base: almost flat with few slight thumb-impressions. Complete.
1130	5035	C 319	C 4	R: 13.5 cm H: 13.3 cm B: 14.5 cm	C 4-5b	Ware: medium coarse red. Temper: grit and some chaff. Decoration: uneven spiral groove. Base: pronounced and even pie-crust. Complete.
1131	5036	C 319	C 4	R: 15.0 cm H: 12.5 cm B: 13.5 cm	C 4-5	Ware: medium coarse buff. Temper: grit and some chaff. Rim: traces of bitumen wash. Base: fine and even pie-crust. Complete.
1132	5033	C 319	C 4	R: 14.5 cm H: 13.7 cm B: 11.0 cm	C 5	Ware: medium coarse grey-buff. Temper: grit and chaff. Base: almost non-existent pie-crust. Complete.
1133		C 68	C 4	R: 16.0 cm H: 15.2 cm B: 15.0 cm	C 4-5	Ware: medium coarse buff. Temper: grit and chaff. Rim: traces of bitumen wash. Base: almost non-existent pie-crust. Profile.
1134		A 727	A 6	R: 16.5 cm H: 15.3 cm B: 16.0 cm		Ware: medium coarse green-buff. Temper: grit and chaff. Base: almost non-existent pie-crust. Profile.

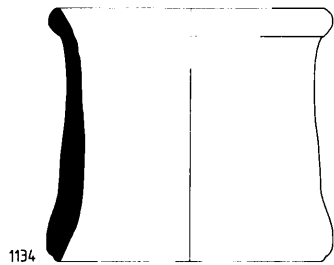
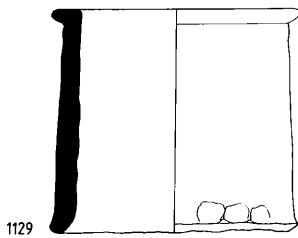
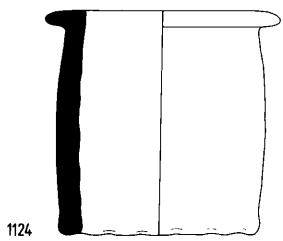
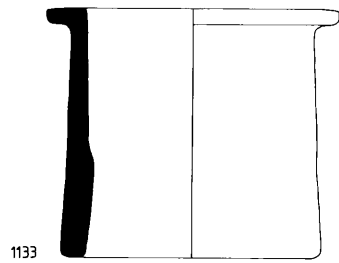
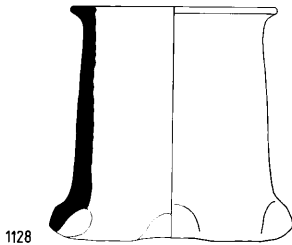
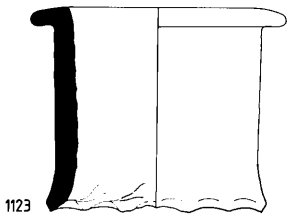
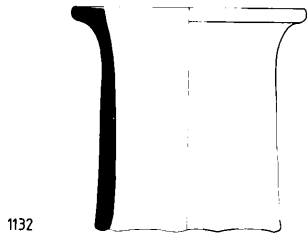
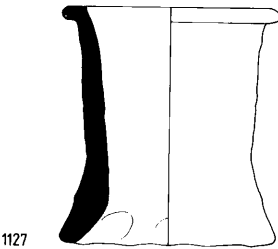
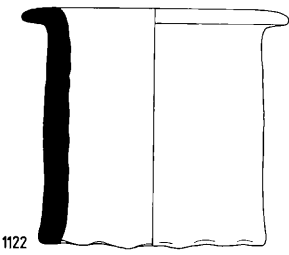
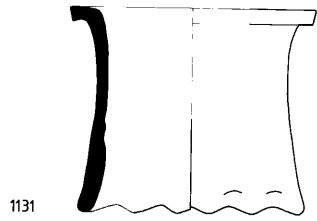
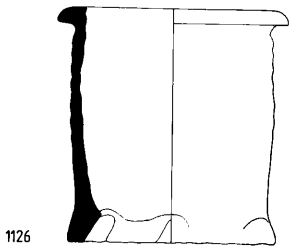
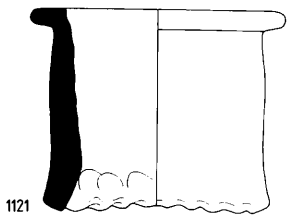
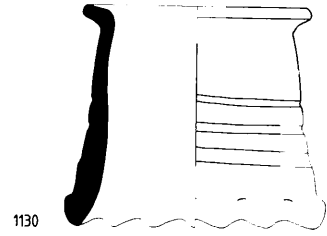
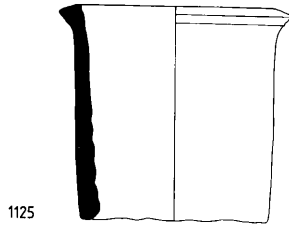
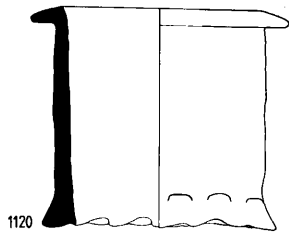

PLATE 95

POTSTANDS

Pot No	TR No	Batch	Level	Dimensions	Range	Ware and Remarks
1135	3123	A 416	A LA	R: 22.4 cm H: 17.5 cm		Ware: coarse red-buff. Temper: grit and chaff. Complete.
1136	5015	C 213	C 1	R: 27.0 cm H: 14.5 cm	A 1	Ware: medium coarse green-buff. Temper: grit and chaff. Complete.
1137	4117	A 592 LA shrine	A LA	R: 14.2 cm H: 10.7 cm	C Tops	Ware: coarse light buff. Temper: grit and chaff. <i>In situ</i> supporting Pot 948. Complete. Plate 26a,b
1138		A 578	A LA	R: 18.5 cm H: 12.0 cm		Ware: coarse buff. Temper: grit and chaff. Profile.
1139		A 340	A 1	R: 24.5 cm H: 14.6 cm	A 2 C 1	Ware: coarse buff. Temper: grit and chaff. Profile.
1140		A 47	A 2a	R: 27.5 cm H: 16.2 cm	A 2	Ware: coarse green-buff. Temper: grit and chaff. Profile.
1141		C 670	C 5	R: 25.5 cm H: 17.7 cm	C 5	Ware: coarse green. Temper: grit and chaff. Profile.
1142		C 670	C 5	R: 23.5 cm H: 15.0 cm	A 1	Ware: coarse green. Temper: grit and chaff. Profile.
1143	175	A 55	A 2b	R: 20.0 cm H: 14.0 cm	A 2 C 5	Ware: coarse buff. Temper: grit and chaff. Complete.
1144		C 646	C 5	R: 25.0 cm H: 15.6 cm		Ware: coarse orange-buff. Temper: grit and chaff. Decoration: applied cable rib. Profile.
1145		A 228	A 1b	R: 18.0 cm H: 17.6 cm	A 2b C 4-5	Ware: coarse green-buff. Temper: grit and chaff. Holes: 2 extant, possibly originally three. Profile.
1146	6001	C 670	C 5	R: 27.0 cm H: 20.8 cm		Ware: coarse green, warped and uneven. Temper: grit and chaff. Holes: 4, evenly spaced. Complete.
1147		C 670	C 5	R: 26.0 cm H: 21.8 cm	A 2	Ware: coarse green. Temper: grit and chaff. Holes: three, evenly spaced. Almost complete.
1148		C 677	C 5	R: 25.0 cm H: 16.5 cm	A 1	Ware: coarse green, very warped and uneven. Temper: grit and chaff. Holes: 3. Almost complete.
1149	2133	C	C 2-3	R: 28.0 cm H: 27.0 cm	A 1-3 C 5	Ware: medium coarse green. Temper: grit and chaff. Holes: three triangular. Decoration: herring-bone on rim, cables below. Complete.
1150	2124	C	C 2-3	R: 25.0 cm H: 36.5 cm	C 1-4	Ware: medium coarse green. Temper: grit and chaff. Holes: three triangular. Decoration: herring-bone on rim, cables below. Complete.
1151		A 555 A 556	A 3	R: 31.0 cm H: 16.2 cm		Ware: coarse buff. Temper: grit and chaff. Holes: five, evenly spaced. Almost complete.
1152		C 657	C 5	R: 27.5 cm H: 11.8 cm	A 3	Ware: very coarse green, overfired. Temper: grit and chaff. Holes: one only extant. Base: broken in centre. Profile.
1153		C 535	C 3	R: 23.6 cm H: 17.2 cm		Ware: coarse green. Temper: grit and much chaff. Base: broken in centre. Profile.
1154	2122	C	C 3-4	R: 27.0 cm H: 20.6 cm		Ware: coarse pink to buff. Temper: grit and chaff. Base: hole in centre D: 5.0 cm. Complete.
1155	2123	C	C 3	R: 23.0 cm H: 26.0 cm		Ware: coarse light green. Temper: grit and chaff. Base: hole in centre D: 5.0 cm. Holes: two large oblong on opposite sides of pot. Complete.
1156		C 696	C 6a	R: 21.5 cm H: 26.1 cm	A 3 C 5-6	Ware: medium coarse dark brown. Temper: grit and chaff. Base: hole in centre D: 2.8 cm. Holes: three triangular. Profile.
1157	3134	A	A 1	R: 21.0 cm H: 16.0 cm		Ware: coarse buff. Temper: chaff. Base: very rough, with traces of bitumen outside. Complete.
1158		A 407	A 2	R: 24.0 cm H: 21.2 cm		Ware: coarse buff to red. Temper: white grit and chaff. Base: lemon-shaped hole in centre D: 17.0 cm. Holes: three triangular. Profile.
1159		A	A 3	R: 46.5 cm H: 20.2 cm		Ware: coarse buff. Temper: grit and chaff. Base: 3 legs with concave bases. Holes: 3 triangular. Profile.
1160		C 249	C 4	R: 14.5 cm H: 7.9 cm	C 4-5	Ware: medium coarse buff. Temper: grit and chaff. Surface: smoothed. Profile.
1161		C 933	C 4	R: 8.4 cm H: 7.3 cm		Ware: medium coarse buff. Temper: chaff. Profile.
1162		C 951	C 6	R: 19.3 cm H: 8.4 cm		Ware: medium coarse yellow, warped. Temper: grit and much chaff. Base: rough, folded in. Profile.
1163		A 667	A 3	R: 8.3 cm H: 2.3 cm	C 3-5	Ware: medium coarse buff. Temper: grit and chaff. Base: folded inwards. Profile.
1164		A 671	A 4	R: 11.0 cm H: 4.3 cm		Ware: medium coarse buff. Temper: grit and chaff. Profile.

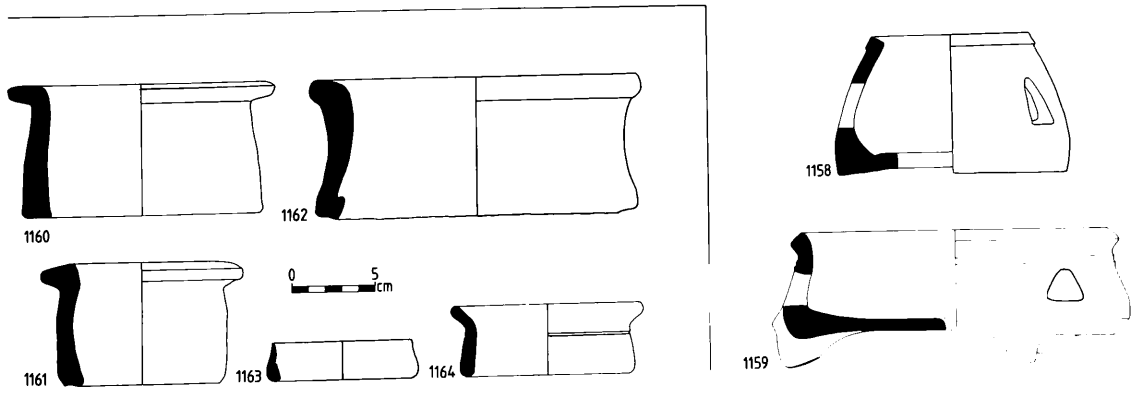
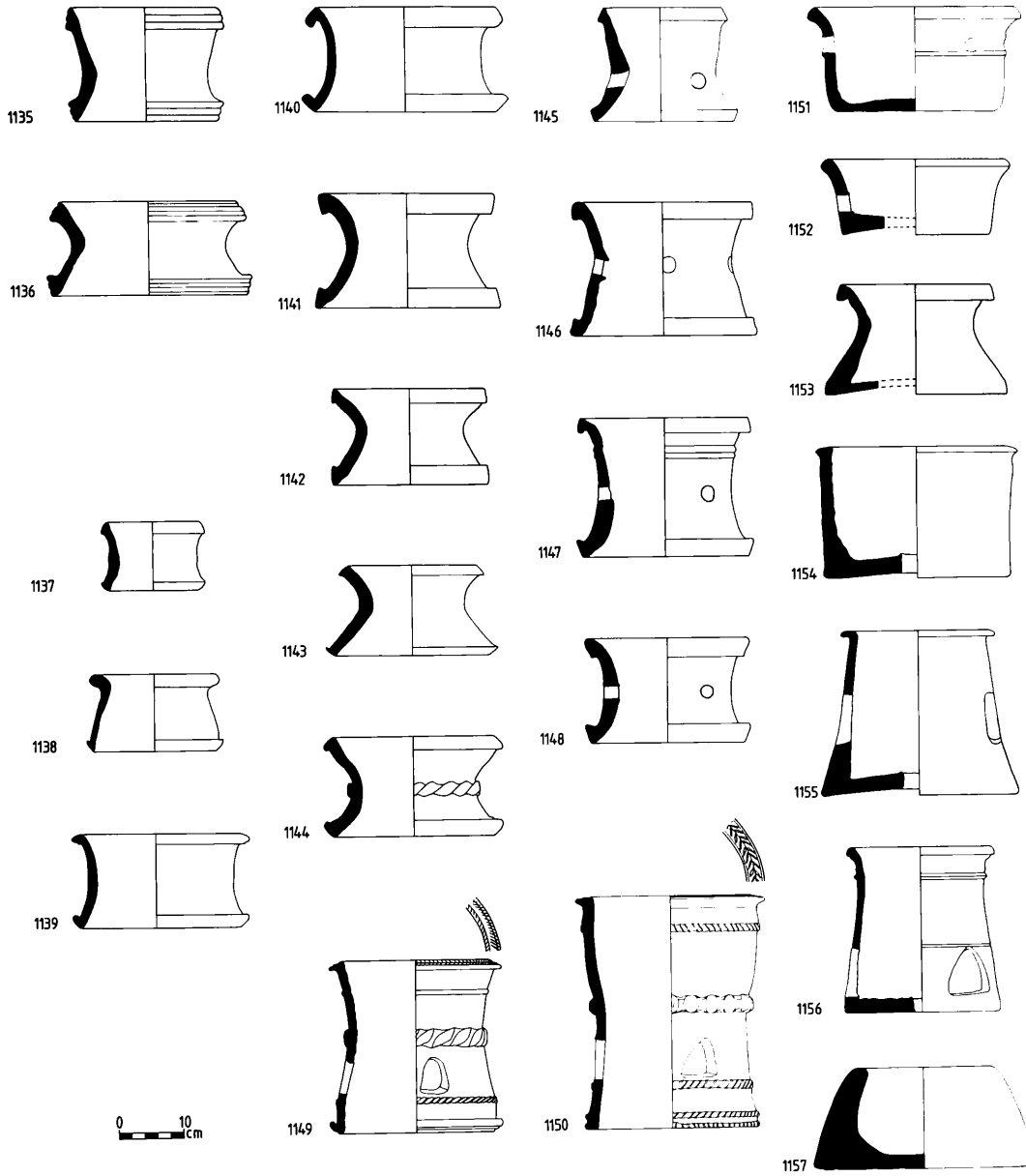

PLATE 96

FENESTRATED STANDS – OLD BABYLONIAN

Pot No	TR No	Batch	Level	Dimensions	Range	Ware and Remarks
1165	4125	C 83	C 5B	R: 19.5 cm H: 17.5 cm B: 21.7 cm	C 6	Ware: coarse light buff. Temper: grit and chaff. Base: hole in centre D: 2.0 to 3.6 cm. Windows: three large triangular. Found on a baked brick in the middle of the room. Signs of heavy burning on brick and base of pot. Almost complete.
1166		C 950	C 6a	R: 19.6 cm H: 18.2 cm B: 23.5 cm	C 5-6	Ware: coarse green. Temper: grit and chaff. Base: broken at centre. Windows: two rounded triangular extant, probably originally three. Profile.
1167		C 679	C 6a	R: 15.8 cm H: 15.8 cm B: 23.0 cm	C 5-6a	Ware: medium coarse buff. Temper: grit and chaff. Base: broken at centre. Windows: two triangular extant, probably originally three. Very roughly made. Profile.
1168	3135	A 465	A 3	R: 14.0 cm H: 15.2 cm B: 21.0 cm	C 56a	Ware: coarse buff. Temper: chaff. Base: hole in centre D: 1.2 to 3.0 cm. Windows: two triangular extant, probably originally three. Profile.
1169		C 950	C 6a	R: 19.0 cm H: 19.8 cm B: 25.6 cm	C 6	Ware: medium coarse green. Temper: grit and chaff. Base: broken at centre. Windows: three triangular. Profile.
1170		C 549	C 6a	R: 19.0 cm H: 17.9 cm B: 22.5 cm		Ware: medium coarse green. Temper: grit and chaff. Base: broken at centre. Windows: one triangular extant, probably originally three. Profile.
1171		A	A 3	R: 18.0 cm H: 15.0 cm B: 21.0 cm	A 3 C 6a-6	Ware: coarse buff. Temper: grit and chaff. Base: hole in centre D: 1.3 cm. Windows: one triangular extant, probably originally three. Profile. Found under stair vaults.
1172		C 22	C 5	R: 15.0 cm H: 13.0 cm B: 20.5 cm	C 6a	Ware: coarse buff. Temper: grit and chaff. Base: no hole. Windows: one rectangular extant, possible originally three. Profile.

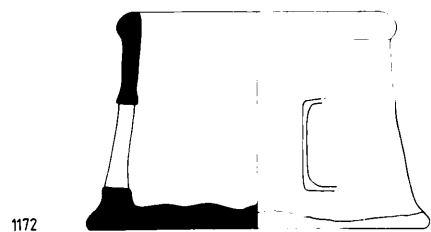
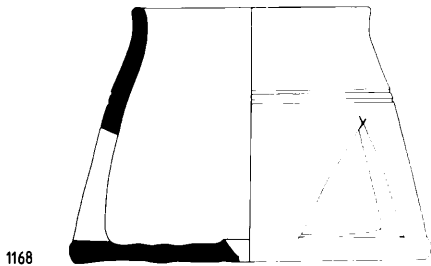
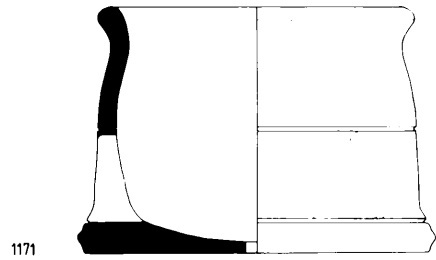
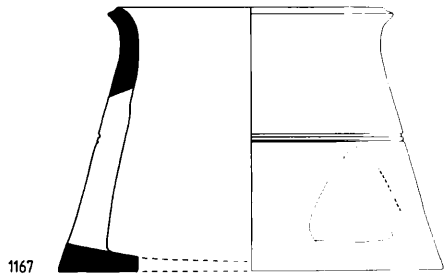
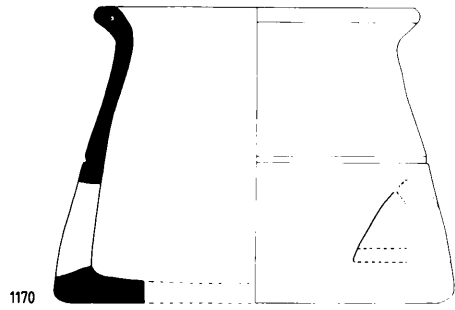
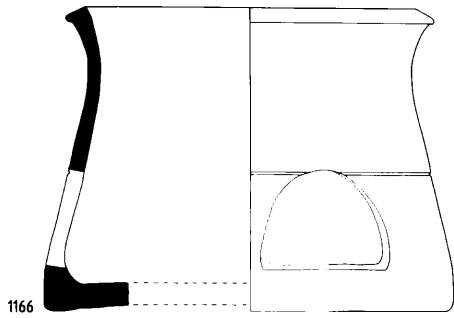
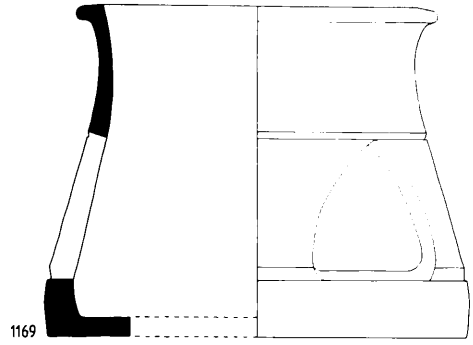
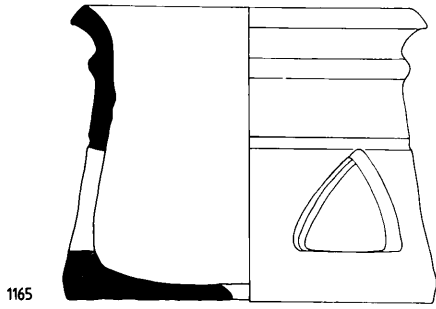

PLATE 97

LATE ASSYRIAN STANDS – DRAIN-PIPE – OVEN

Pot No	TR No	Batch	Level	Dimensions	Range	Ware and Remarks
1173	4128	A 592 LA shrine	A LA	H: 70.0 cm B: 30.5 cm		Ware: coarse pale orange-buff. Temper: white grit and chaff. Rim: missing. Decoration: four horizontal fluted raised bands. No traces of burning. Complete but for rim.
1174	4129	A 592 LA shrine	A LA	R: 14.0 cm H: 59.0 cm B: 26.0 cm		Ware: coarse orange-buff. Temper: white grit and chaff. Decoration: two incised wavy lines and two carinations with vertical slashes. Windows: six oval in two registers. No traces of burning. Almost complete.
1175	4127	A 592 LA shrine	A LA	H: 52.0 cm B: 26.0 cm		Ware: medium coarse buff. Temper: grit and chaff. Rim: missing. Decoration: horizontal ribs with vertical slashes and incised wavy lines all over. Windows: narrow rectangular in two registers, three in the lower set and three, possibly originally four, in the upper set. Almost complete. Plate 26d
1176	6014	C 650	C 1	R: 21.0 cm H: 37.5 cm B: 21.0 cm		Ware: coarse green. Temper: grit and chaff. Drain-pipe, found in a Late Assyrian drain. Complete.
1177		C 220	C 3-4	R: 25.0 cm H: 55.8 cm B: 34.0 cm	C 5b	Ware: very coarse brick red, probably unfired except by use as an oven. Temper: some grit and much chaff. Holes: two round set one above the other and one larger rounded oblong below. Drawn <i>in situ</i> , therefore the thickness of the base is approximate. Complete.

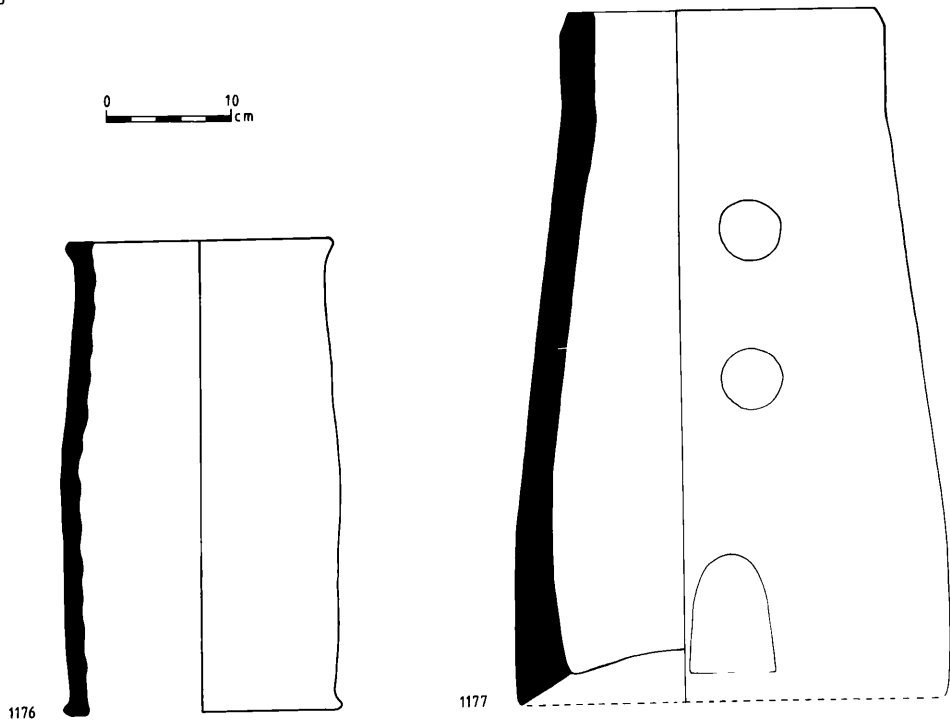
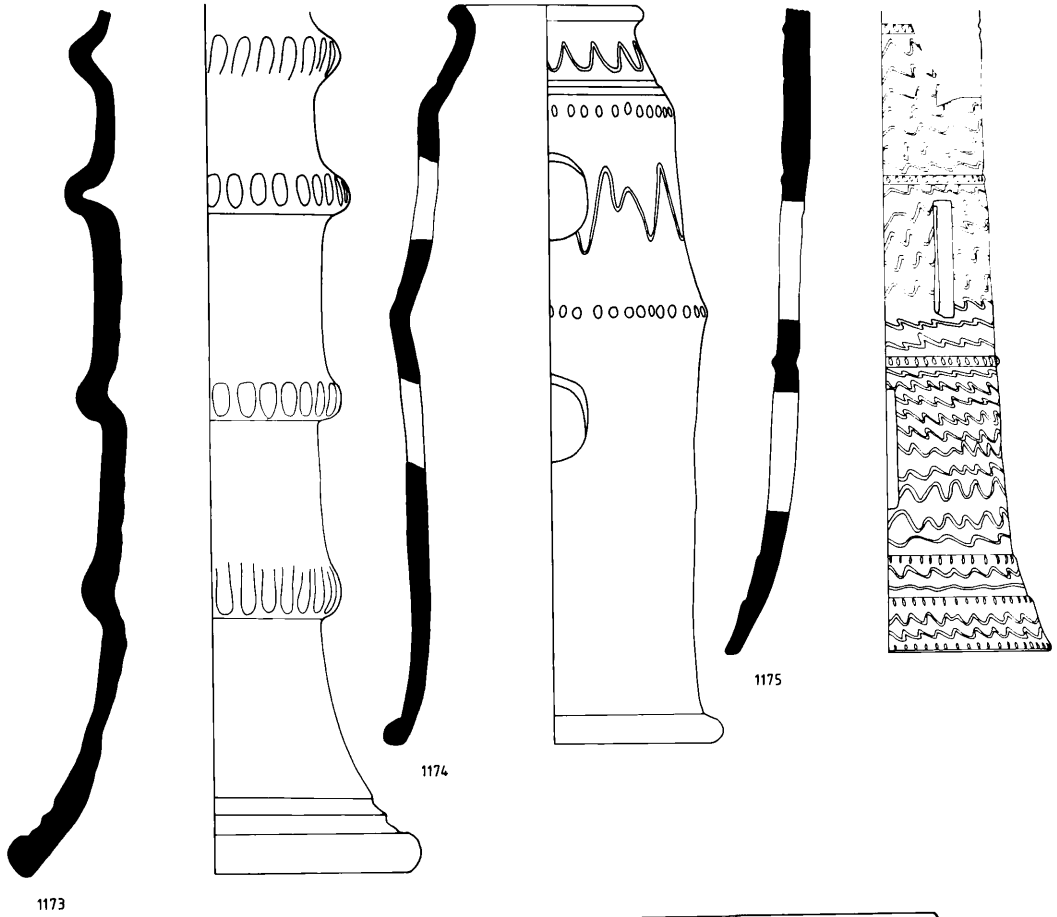

PLATE 98

TALL STANDS – MITANNI AND OLD BABYLONIAN

Pot No	TR No	Batch	Level	Dimensions	Range	Ware and Remarks
1178	3106	A 463	A 3 late	R: 13.0 cm H: 62.5 cm B: 18.0 cm		Ware: medium coarse buff. Temper: grit and chaff. Decoration: plain broad horizontal ribs. Handles: areas of attachment extant for two vertical handles on opposite sides of the stand. Almost complete.
1179		C 1015	C 6	D: 22.0 cm H: 45.0 cm		Ware: medium coarse green. Temper: grit and chaff. Decoration: deep horizontal grooves at intervals. Handles: stubs extant of two vertical handles on opposite sides of the stand. Rim: missing. Base: missing. Almost complete.
1180	4121	A 594	A 3	R: 9.2 cm H: 36.7 cm B: 15.0 cm		Ware: medium coarse orange-buff. Temper: grit and chaff. Paint: red horizontal bands. Windows: four triangular with apexes pointing alternately upwards and downwards. Almost complete. Plate 24a
1181		A 624 A 628	A 3	H: 11.0 cm W: 11.2 cm		Ware: medium fine buff. Temper: grit and chaff. Paint: thick red with splashes inside. Bodysherd.
1182	5030	C 349	C 5b	H: 46.0 cm B: 19.0 cm	C 5	Ware: medium fine buff to pink. Temper: grit and chaff. Paint: very worn dark brown or black. Pattern: as drawn, except for the vertical strokes near the base, which sometimes occur in groups of four. Decoration: horizontal ribs and grooves. Handles: stubs extant of two vertical handles on opposite sides of the stand. Windows: triangular, in two registers with four in the upper and five smaller in the lower. Rim: missing. Almost complete.
1183	4131	A 565	A 3	H: 36.0 cm B: 19.0 cm		Ware: medium coarse yellow-buff. Temper: grit and chaff. Decoration: horizontal ribs and grooves. Windows: in two registers, four triangular in the upper and five narrow rectangular in the lower. Rim: missing. Almost complete.
1184	4104	A	A 2c	D: 18.0 cm H: 36.5 cm	A 1-2a	Ware: medium coarse green. Temper: grit and chaff. Decoration: horizontal ribs. Windows: four alternately triangular and narrow rectangular. Rim: missing. Base: missing. Bodysherd.
1185		C 947	C 6a	D: 16.0 cm H: 28.8 cm		Ware: medium coarse green, very overfired and warped. Temper: grit and chaff. Decoration: horizontal ribs. Windows: three triangular with traces of probably four narrow rectangular in an upper register. Rim: missing. Base: missing. Bodysherd. used as a drain.

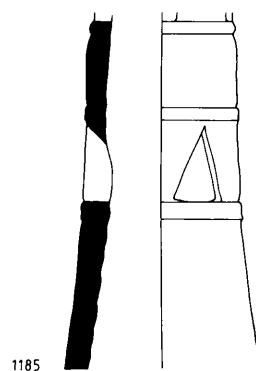
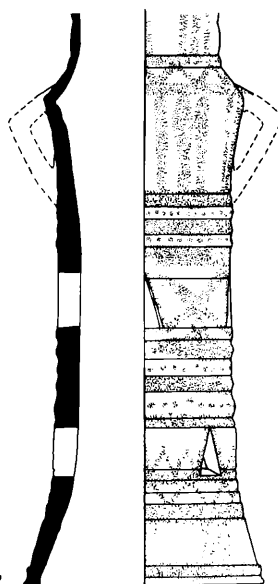
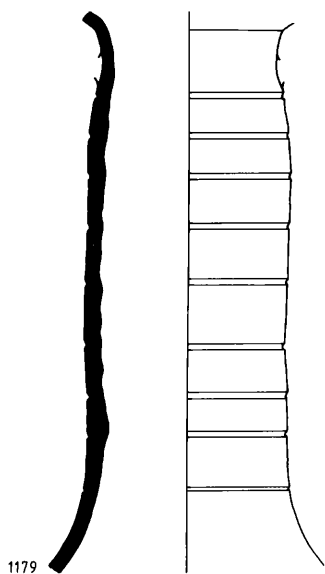
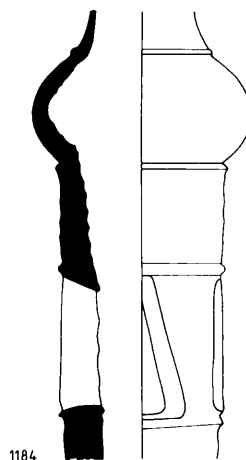
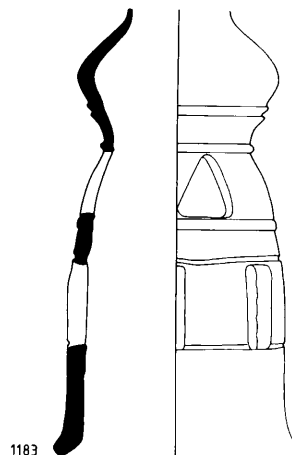
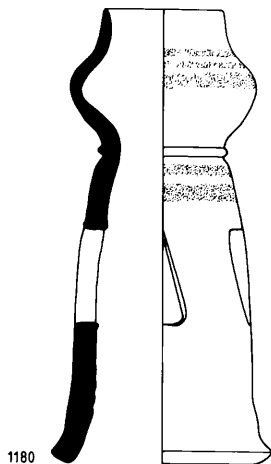
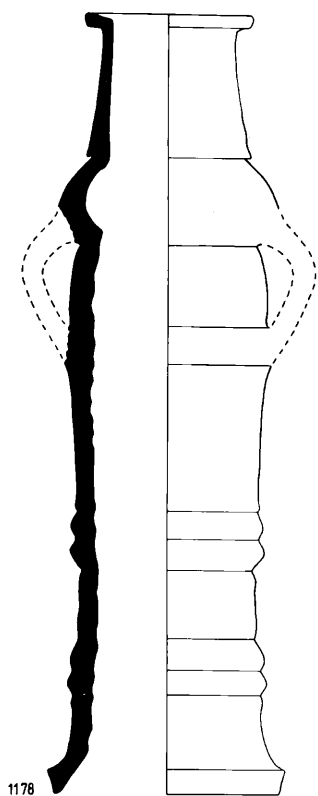

PLATE 99

MITANNI "PIG POTS" AND MISCELLANEOUS VESSELS

Pot	TR	Batch	Level	Dimensions	Range	Ware and Remarks
1186	2119	A 336	A 2a-b	H: 10.1 cm L: 14.1 cm W: 9.2 cm	A 1	Ware: medium fine light green. Temper: grit and chaff. Paint: faded brown. Pattern: as drawn, except for traces of two circles on the back. Decoration: feet, dugs and tail consist of applied clay, while the eyes and ears are modelled in slight relief. The snout is broken but may have served as a spout. Rim: the upper surface is decorated with a series of small holes. Inside the body is a funnel originally reaching nearly to the base. Almost complete. Plate 20d
1187		A 326	A 2c	L: 4.3 cm L: 4.3 cm		Ware: fine pink to cream. Temper: grit. Paint: red. Pattern: random strokes. Decoration: one foot and six dugs of applied clay. Two bodysherds of the same vessel.
1188		A 329	A 2c	L: 4.3 cm		Ware: fine pink to cream. Temper: grit. Paint: red. Pattern: random strokes. Decoration: one foot of applied clay. Bodysherd.
1189	3107	D 93	D 4	H: 10.3 cm L: 13.7 cm W: 9.8 cm		Ware: medium fine light green. Temper: grit and chaff. Decoration: six dugs and tail of applied clay, eyes and ears modelled in slight relief. Between the eyes is scratched a diagonal cross. The snout is broken but may have served as a spout. Rim: the upper surface is decorated with a series of small holes. Inside the body is a funnel reaching nearly to the base. On the right flank is inscribed an indecipherable cuneiform sign. Almost complete.
1190	2120	C	C ?	H: 16.5 cm L: 20.8 cm W: 11.0 cm	A 1-2a C 3	Ware: coarse light green. Temper: grit and chaff. Decoration: the tail is of applied clay with horizontal incisions. Instead of feet there are broad applied lugs (only one extant) pierced horizontally to admit axles for wheels. Next to the aperture at the top is the stump of head or neck, now broken. Surface: traces of a plaster coating on the underbelly and on existing and missing lugs suggest repairs in antiquity. Incomplete.
1191		C 713	C 4	H: 17.0 cm L: 20.0 cm W: 12.6 cm	A 2c C 5b-6	Ware: medium coarse buff. Temper: grit and chaff. Decoration: no tail but incised concentric circles around front aperture. Instead of feet there are broad applied lugs (only one extant) pierced horizontally to admit axles for wheels. Further forward from the aperture at the top is a large area of attachment for head or neck. Incomplete.
1192	3108	A 473	A 1	H: 6.5 cm L: 12.0 cm W: 12.0 cm		Ware: coarse green. Temper: grit and chaff. Handmade. The interior is a square box with a hollow clay tube applied to one side and bending in towards the centre. Decoration: applied band with vertical slashes around the outside, with niches below and castellations above. There are further applied castellations on the top edges and corners. Possibly an architectural model. Almost complete. Plate 24e
1193	2144	A 291	A 2a-b	H: 6.0 cm L: 8.9 cm W: 7.8 cm		Ware: coarse green. Temper: grit and chaff. Handmade. The interior is a square tray with one side formed into a pouring lip. On the outside is a horizontal ruff and groove formed by pinching out the clay, while below the lip is a crudely-modelled figure, possibly a bird. The vessel stands on four round legs, now broken. There are traces of burning, particularly in the tray. Possibly an incense burner. Incomplete.
1194	4337	C 76	C 5	D: 36.0 cm H: 4.0 cm B: 35.0 cm		Ware: medium coarse red. Temper: grit and chaff. Handmade, probably in a mould. Decoration: moulded designs in concentric circles. Base: scraped and partially smoothed. Possibly a bread mould. Incomplete. Plate 24c
1195		C 676	C 5b	D: 10.0 cm H: 3.0 cm	A 3	Ware: medium coarse red to cream. Temper: grit and chaff. Handmade, fairly rough. Handle: formed by pinching up the clay in the centre. Holes: probably fairly evenly spaced (five extant on sherds). Probably a lid. Incomplete.
1196		C 80	C 5b	D: 13.5 cm H: 5.4 cm		Ware: fine brown buff. Temper: grit and chaff. Paint: orange-brown. Pattern: as drawn, inside and out. Handle: irregular knob in centre. Probably a lid. Profile.

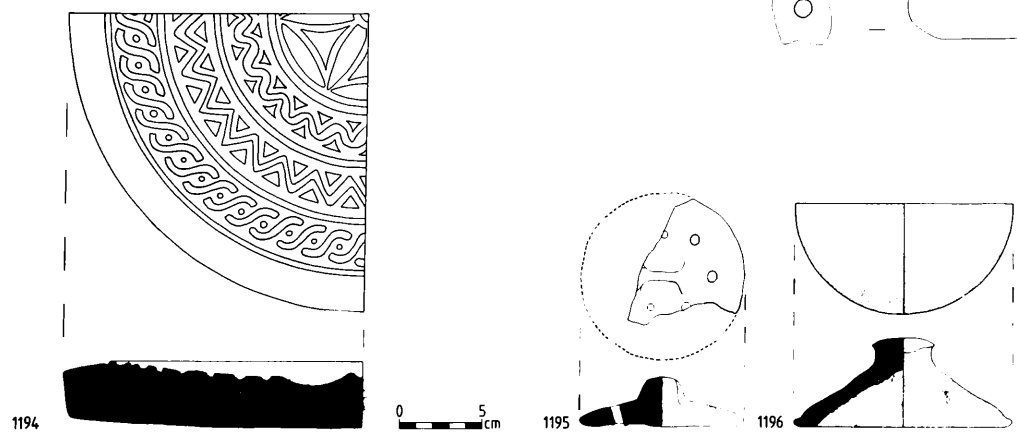
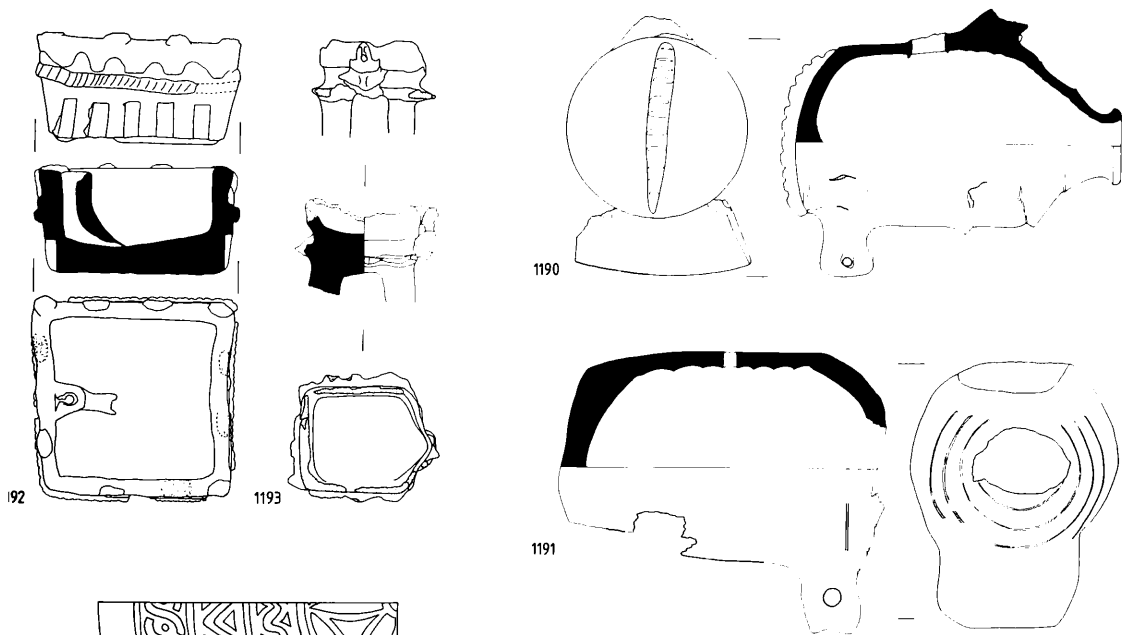
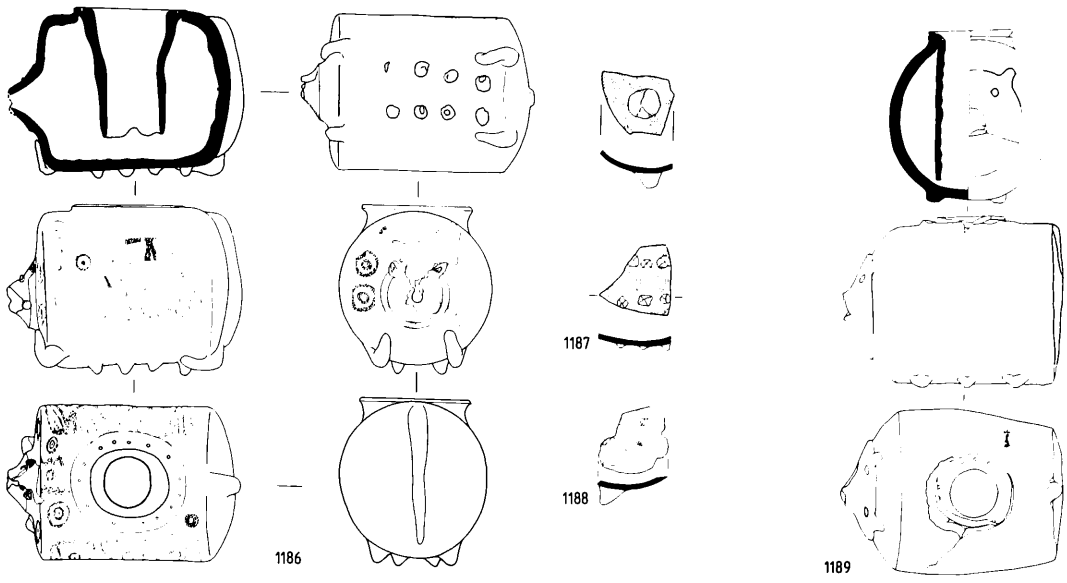

PLATE 100 TRIPOD VESSELS – INCISED GREY WARE – FOOTED VESSELS

Pot	TR	Batch	Level	Dimensions	Range	Ware and Remarks
1197	2108	C	C 3	R: 11.0 cm H: 18.0 cm B: 11.5 cm		Ware: medium coarse light green. Temper: grit and chaff. Paint: brown, in uneven horizontal bands. Legs: three short rectangular (two extant). Almost complete.
1198		A 277	A 1	R: 11.0 cm H: 5.3 cm		Ware: medium coarse buff to cream. Temper: grit and chaff. Surface: well smoothed. Legs: three applied to the sides of the bowl and connected by three flat struts 0.9 cm wide. Almost complete.
1199		A 277	A 1	R: 11.5 cm H: 4.7 cm		Ware: medium coarse buff. Temper: grit and chaff. Handmade. Surface: smoothed. Legs: three applied to the sides of the bowl, roughly modelled and attached to the base (two extant). Profile.
1200	2101	C	C 5	R: 14.0 cm H: 5.0 cm	A 2b C 1-5	Ware: medium fine green-buff. Temper: white grit and chaff. Legs: three applied rounded (two extant). Almost complete.
1201		C 335	C 5b	R: 12.0 cm H: 6.6 cm		Ware: medium fine buff fired pink to cream in places. Temper: grit and some chaff. Surface: burnished inside and out. Legs: three roughly applied broad and pointed (one extant on sherd). Profile.
1202	6017	C 591	C 5	R: 11.0 cm H: 5.9 cm		Ware: fine grey-brown. Temper: none. Surface: burnished inside and out. Legs: 3 broad and out-turned with incised claws (one extant on sherd). Decoration: 2 rows of impressed triangles on rim and squares on legs, probably originally white-infilled. Profile. Plate 23d
1203		A 565	A 3	R: 13.8 cm H: 4.6 cm		Ware: medium fine grey-brown. Temper: grit and chaff. Surface: burnished inside and out. Decoration: grooves below rim. Legs: 3 rounded, stumps of 2 extant. Profile.
1204		C 346	C 5	R: 28.4 cm H: 9.8 cm B: 13.5 cm	C 4	Ware: medium fine buff to white. Temper: grit and chaff. Surface: lightly burnished inside and out. Legs: three handle-shaped applied to lower part of bowl and ring-base (one extant on sherd). Profile.
1205		C 574	C 5	W: 7.5 cm H: 11.7 cm		Ware: fine light grey. Temper: large white grit. Surface: burnished out vertically above carination and horizontally below. Decoration: white-filled incised large triangles and impressed small triangles. 2 bodysherds. Plate 23d
1206		A 610	A 4	H: 5.1 cm	A LA-3	Ware: medium fine grey. Temper: grit and chaff. Surface: lightly burnished with vertical marks on neck. Decoration: white-infilled incised lines and impressed dots, possibly triangles below. Rim sherd.
1207			Surface	W: 2.0 cm H: 1.7 cm		Ware: medium fine grey. Temper: grit. Surface: smoothed. Decoration: white-filled incised lines, triangles and dots. Bodysherd.
1208		C 197 C 210	C 3	R: 11.0 cm H: 2.7 cm		Ware: medium fine grey. Temper: grit and chaff. Surface: not burnished. Decoration: impressed triangles on rim, possibly originally white-infilled. Profile.
1209		C 1006	C 5	H: 2.3 cm		Ware: fine brown. Temper: grit and chaff. Surface: highly burnished in and out. Decoration: white-filled impressed triangles and small roundels. 2 rim sherds. Plate 23d
1210		C 225	C 3	W: 6.0 cm H: 4.4 cm	A 3 C 5	Ware: medium fine grey. Temper: grit. Surface: lightly burnished inside and out. Decoration: incised circles and impressed triangles, all white-infilled. Rim sherd. Pl. 19e
1211		A 16	Mixed	W: 5.5 cm H: 3.7 cm		Ware: medium fine grey. Temper: grit. Surface: burnished inside and out. Decoration: white-infilled incised triangles and small impressed triangles. Rimsherd.
1212		A 449	A 3	W: 6.0 cm H: 2.6 cm		Ware: medium fine grey. Temper: white grit. Surface: probably originally burnished. Decoration: incised line and possibly triangles above wavy overhanging carination. Bodysherd.
1213	4101	B	B LA	R: 5.0 cm H: 21.0 cm		Ware: medium fine pink. Temper: grit and chaff. Surface: heavily burnt at the top. Almost complete.
1214	4120	A 592 LA shrine	A LA	H: 13.5 cm B: 8.7 cm		Ware: medium coarse buff. Temper: grit and chaff. Rim: missing. Almost complete.
1215		D 97	D 4	H: 5.8 cm B: 10.0 cm	C 4-5	Ware: medium fine light pink-buff. Temper: grit and chaff. Base: high pedestal, rest of pot missing. Base sherd.
1216		A 446	A 3	R: 9.6 cm H: 9.5 cm		Ware: medium fine orange fired plum red in places with dark buff core. Temper: grit and chaff. Surface: traces of burning inside bowl. Profile.
1217	5011	A 644	A 4	R: 10.5 cm H: 14.0 cm B: 7.0 cm		Ware: medium fine buff with dark core. Temper: white grit and chaff. Surface: smoothed. Windows: two ovoid on opposite sides of high pedestal base. Almost complete.
1218	5049	C 395	C 6	R: 10.0 cm H: 7.0 cm	A 2c-3 C 1-7	Ware: fine buff. Temper: fine grit. Surface: smoothed. Almost complete.

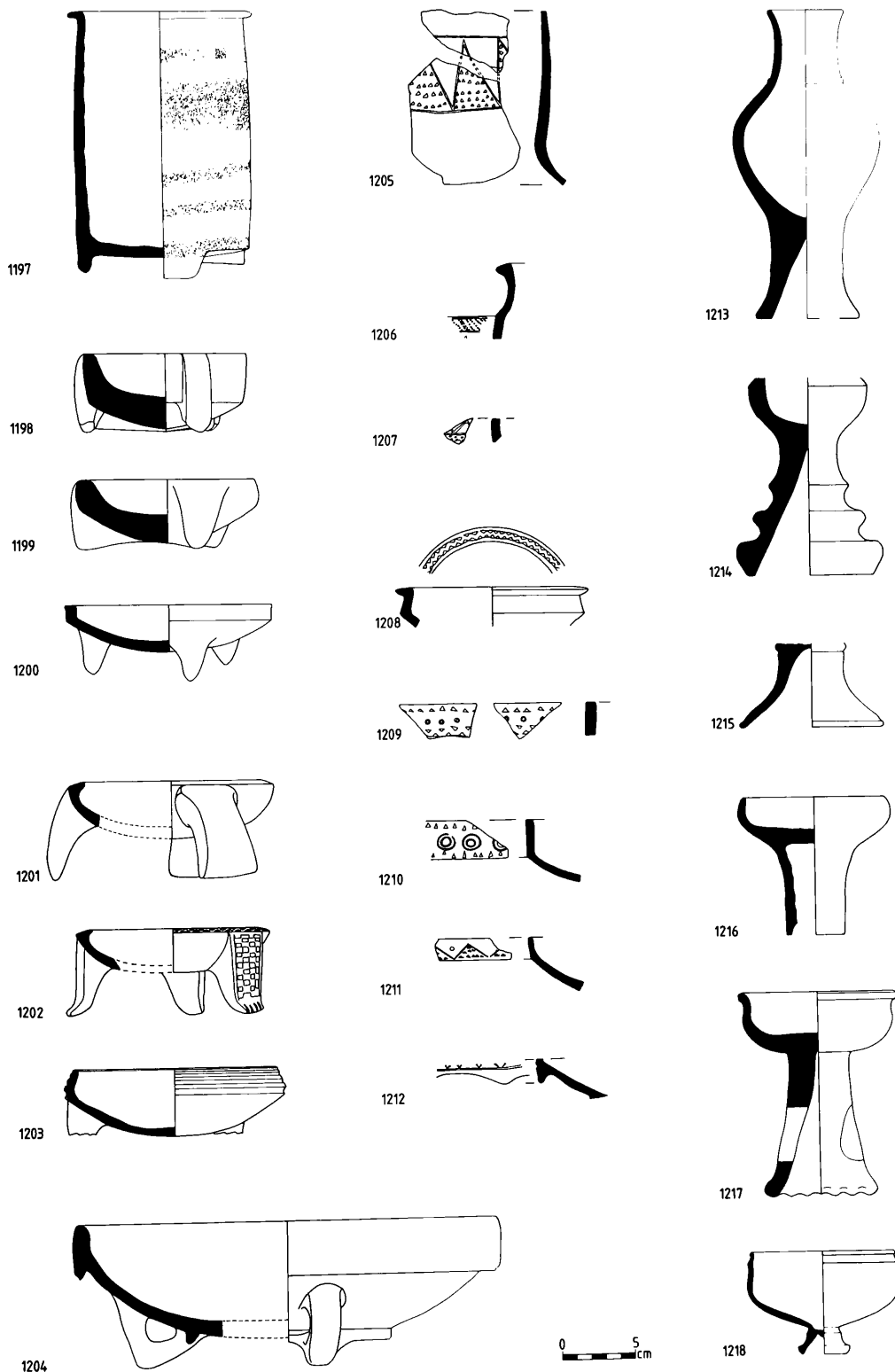
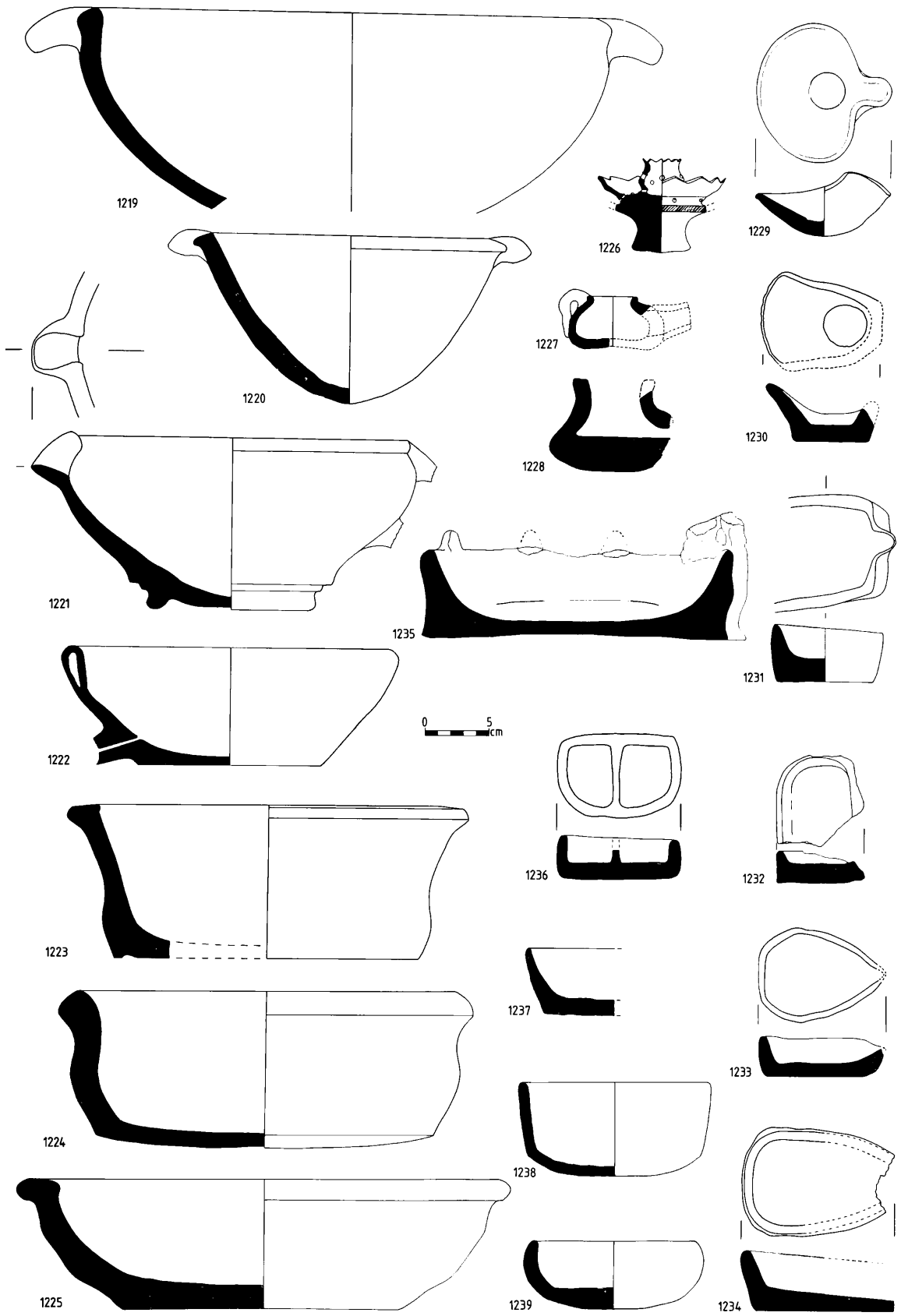

PLATE 101

BOWLS AND LAMPS

Pot	TR	Batch	Level	Dimensions	Range	Ware and Remarks
1219		A 353	A 1	R: 39.0 cm H: 15.3 cm	C 1	Ware: coarse red with dark grey core. Temper: sandy grit and much chaff. Handles: two large lugs. Profile.
1220		D 62	D 3	R: 21.5 cm H: 13.0 cm		Ware: medium coarse brick red with dark buff core. Temper: white grit. Surface: burnished inside and out. Profile.
1221	2608	A 266	A 1	R: 25.5 cm H: 13.4 cm B: 12.0 cm		Ware: medium coarse buff. Temper: grit. Surface: glaze inside and out, originally pale green faded to white. Rim: pinched to form rounded spout. Handle: vertical strap, broken. Almost complete. Plate 25a
1222		A 565	A 3	R: 24.5 cm H: 9.1 cm B: 14.0 cm		Ware: medium coarse buff. Temper: grit and chaff. Surface: traces of burnishing on flat base. Rim: folded inwards to leave a gap in some places. Spout: long narrow spout near base. Profile.
1223		C 391	C 6a	R: 26.0 cm H: 11.9 cm B: 23.5 cm	C 6a	Ware: very coarse buff. Temper: chaff. Profile.
1224		A 565	A 3	R: 28.8 cm H: 12.0 cm B: 26.0 cm		Ware: very coarse buff. Temper: grit and chaff. Ancient break mended with bitumen. Surface: traces of bitumen and plaster over all. Profile.
1225		C 594	C 6a	R: 36.4 cm H: 10.0 cm B: 21.0 cm		Ware: coarse buff. Temper: grit and chaff. Profile.
1226		A 86	A 1	R: 10.0 cm H: 7.2 cm B: 4.6 cm		Ware: fine green-buff. Temper: grit and chaff. Upper tulip-shaped cup is pierced with many holes. The larger saucer below has fewer holes leading to a lower part now broken. Traces of bitumen on spikes. Lamp. Incomplete.
1227		C 725	C 2	R: 4.0 cm H: 4.1 cm B: 5.0 cm		Ware: coarse yellow. Temper: grit. Surface: green glaze inside and large drips of glaze out over upper half. Handle: small vertical. Spout: trace extant. Lamp. Incomplete. Perhaps Parthian or later.
1228		D 119	D 3	W: 9.4 cm H: 7.2 cm		Ware: very coarse grey-buff, low-fired. Temper: much chaff. Handmade, ovoid in shape. Rim: broken. Spout: beginning extant on one side, on the long axis of the pot. Lamp. Incomplete.
1229	5010	C 107	C 1	H: 5.0 cm L: 10.6 cm W: 10.7 cm		Ware: medium fine red-orange. Temper: grit and some chaff. Rim: pinched to form spout. Lamp. Complete.
1230		D 105 D 110	D 3	H: 4.5 cm L: 8.6 cm B: 5.8 cm		Ware: very coarse grey. Temper: much grit. Handmade. Rim: high at one end, low at the other. Lamp. Incomplete.
1231		A 473	A 1	H: 4.5 cm L: 9.8 cm W: 9.0 cm		Ware: coarse red-buff. Temper: grit and chaff. Handmade, irregular. Lamp. Incomplete.
1232		C	C 1-2	H: 2.5 cm L: 7.1 cm W: 7.0 cm		Ware: medium coarse green. Temper: grit and chaff. Handmade, probably originally oval in shape. Base: fire-blackened. Possibly a lamp. Incomplete.
1233	6045	C 679	C 6a	H: 3.1 cm L: 9.8 cm W: 7.4 cm	A 2c	Ware: coarse red with grey core. Temper: grit and much chaff. Hand-made, triangular in plan with apex pinched to form lip on which there are traces of burning. Pot B <i>Figure 11</i> . Lamp. Complete.
1234		C 958	C 6	H: 4.6 cm L: 12.2 cm W: 8.4 cm		Ware: coarse buff with grey core. Temper: grit and much chaff. Handmade, triangular in plan with apex pinched to form lip, now broken. Much burning inside. Lamp. Incomplete.
1235		C 721	Topsoil	R: 23.5 cm H: 10.0 cm B: 25.5 cm		Ware: medium coarse brown-buff. Temper: grit and chaff. Handmade. Round plate with rim decorated with several triangular protuberances (six extant) and one larger, very roughly modelled, possibly a handle. Three-quarters complete.
1236		C 627	C 4-5	H: 3.5 cm L: 9.6 cm W: 6.6 cm		Ware: medium coarse green. Temper: grit and chaff. Handmade, well finished and base smoothed. Oval dish with central division. Almost complete.
1237		C 936	C 5	H: 5.2 cm L: 7.0 cm W: 6.0 cm		Ware: medium fine buff. Temper: grit and chaff. Handmade, smoothed inside and out. One corner extant of bowl, probably originally rectangular with rounded sides. Profile.
1238		A 402	A 1	R: 14.5 cm H: 7.2 cm	A 2a	Ware: very coarse green. Temper: grit and chaff. Profile.
1239		C 921	C 5b	R: 12.5 cm H: 5.2 cm		Ware: very coarse light buff. Temper: chaff. Handmade. Profile.



INDEX OF BATCHES CONTAINING ILLUSTRATED POTTERY
SITE A

Batch	Joining Batches	Year	Level	Provenance	Pot Numbers
A 6		1964	A 2a-b	Room 28 Floor	1091
A 15		1964	A 1-2	Room 12	111, 1054
A 16		1964	Mixed	Room 14	1211
A 17		1964	A 1	Room 2	29, 46, 651
A 19		1964	Topsoil	Room 32	120
A 20	352	1964	A 2a-b	Room 3 with tablets	76, 82, 687, 859, 861, 989
A 23		1964	A 2	Room 14	98, 645
A 25		1964	A 2c	Room 14	104, 1056
A 32		1964	A 2	Room 13	858
A 33		1964	A 1c	Courtyard Fill	55, 153, 653
A 36	49	1964	Mixed	Cobbled area	116, 117
A 37		1964	A 2c	Room 12 Fill above floor	681
A 38		1964	A 1c	Courtyard	7
A 40		1964	A 2b	Room 40	75
A 41		1964	A 2a-b	Room 2	92, 992
A 42		1964	A 1	Above cobbled path	94, 158, 170, 176, 177, 568, 854, 1071
A 44		1964	A 1	Courtyard	72
A 45		1964	A 3 late	Room XII	222, 472
A 47		1964	A 2a	Room 4	1140 + TR 4132
A 49	36	1964	Mixed	Cobbled area	116, 117
A 55		1964	A 2b	Room 6	1073, 1079, 1143 + TR 174
A 56		1964	A 3	Room XII	324
A 57		1964	A 2a-b	Room 7	79, 856 + TR 161
A 58		1964	A 2-3	Rooms 11, 12	108, 121, 1082
A 61		1964	A 1b	Room 3, 22 with tablets in jar	644, 941 + TR 187
A 62		1964	A 2a-b	Room 21 Floor	97
A 69		1964	A 2b	Room 5	722, 723, 920, 929
A 70		1964	A 1	Above Room 15	1070
A 71		1964	A 1	Courtyard	569
A 72	74, 88, 90	1964	A 2a	Cobbled street south of Room 7	77, 78, 93, 166, 171, 637, 718, 719, 720, 931, 936, 947, 966 + TR 176, TR 181, TR 186
A 74	72, 88, 90	1964	A 2a	Street Fill	cf A 72
A 78		1964	A 1	Room 15 Fill	703
A 80		1964	A 1-2	Room 27	151
A 81		1964	A 1-2	Room 19 over north wall of Level 2	655, 659, 921, 930 + TR 173
A 86		1964	A 1	Above street, batch 74	1226
A 88	72, 74, 90	1964	A 1	Street fill, above batch 72	cf A 72
A 89	98	1964	A 2b-c	Room 7	118
A 90	72, 74, 88	1964	A 2a	Street south of Room 7	cf A 72
A 92		1964	A 2	Room 16	60
A 93	94	1964	A 1	Courtyard	1, 4, 5, 23, 24, 654
A 94	93	1964	A 1	Courtyard	4, 23, 57, 588
A 95		1964	A 2	Room 16	102, 103
A 96		1964	A 1	Room 15	35, 73, 172 + TR 254
A 98	89	1964	A 2a	Rooms 3, 22	51, 118, 901
A 99		1964	A 2c-3	Rooms 11, X	873
A 205		1965	A LA	Above Room 15	650
A 208	282	1965	A 1	Above Room 6	888
A 220		1965	A 2c	Room 2	894
A 225		1965	A 1	Courtyard Fill above Level 1	961
A 228		1965	A 1b	Courtyard, late floor with MA tablets	32, 33, 56, 67, 1066, 1067, 1145

INDEX OF BATCHES CONTAINING ILLUSTRATED POTTERY
SITE A

Batch	Joining Batches	Year	Level	Provenance	Pot Numbers
A 229		1965	A 1	Courtyard, late floor	26
A 231		1965	Topsoil	Courtyard	40
A 232		1965	A 1	Courtyard	6, 705
A 233		1965	A 1	Courtyard	189, 570
A 234		1965	A 1	Courtyard Fill	634
A 236		1965	A 1	Courtyard	28 + TR 2701
A 241		1965	A 1	Courtyard Fill above Level 2	185
A 242		1965	A 1	Courtyard Fill	567
A 243		1965	A 1	Courtyard Fill	21
A 250		1965	A 1	Room 44 Fill above Level 1	65, 886
A 252		1965	Topsoil	Room 19	350, 383
A 254		1965	Topsoil	Room 19	43, 864
A 257		1965	Topsoil	Room 44	9, 39
A 258		1965	A 1	Courtyard Fill above Level 1	49
A 259		1965	A 1	Courtyard	37, 52, 61, 68, 71
A 263		1965	A 2c-3	Room 2	135
A 265		1965	A 2c-3	Room I	439
A 266		1965	A 1	Room 15	1221
A 269		1965	A 1	Room 15 Fill above Level 1	897
A 270		1965	A 1	Room 15	TR 2745a, TR 2745b, TR 2746
A 271		1965	A 1	Courtyard Fill	13, 14, 22
A 272		1965	A 2	Courtyard	575
A 274		1965	A 2	Rooms 42, 41	986
A 277		1965	A 1	Outside East Gate	691, 1198, 1199
A 280		1965	A 2	Outside East Gate, mixed fill	308
A 281		1965	A 1	Room 15 Fill	186
A 282	208	1965	A 1	Room 37 fill above Level 1	888
A 284	285	1965	A 1	Room 37	511, 635
A 285	284	1965	A 1	Room 37	511
A 286		1965	A 1	Room 37	688
A 287		1965	A 1	Room 15	58, 188
A 289		1965	A 1	Room 37 Fill	54, 583, 649
A 290		1965	A 1	Room 16 Fill above Level 1	198
A 291		1965	A 2a-b	Room 44	578, 1193
A 292		1965	A 2a-b	Room 44	144
A 293		1965	A 2	Room 44 (wadi)	38
A 301		1965	A 1	Room 16, with tablets on broken floor	34, 50, 184, 187
A 303		1965	A 1	Room 22 Fill	488, 712
A 305		1965	A 1	Room 22 Fill	932
A 307		1965	A 2a-b	Room 22	577, 737, 962, 963, 976
A 308		1965	A 2	Room 23	99
A 310		1965	A 2	Room 16	18, 20, 731, 733, 933
A 311		1965	A 2	Outside East Gate, mixed fill	1111
A 312		1965	A 2	Outside East Gate, mixed fill	867
A 313		1965	A 2c	Outside East Gate, mixed fill	TR 2603
A 314		1965	A 2	Outside East Gate, mixed fill	163, 270
A 317		1965	A 2	Outside East Gate, mixed fill	343
A 321		1965	Topsoil	Room 22 Upper fill	664
A 324		1965	A 2c-3	Room 43, courtyard	444
A 326		1965	A 2c	Room 24	728, 1187
A 328		1965	A 1	Courtyard	30, 63, 66
A 329		1965	A 2c	Room 43	325, 1188
A 331		1965	A 1	Room 45	648
A 332		1965	A 1	Room 25	173
A 336	343	1965	A 2a-b	Room 24	80, 679, 702, 934, 954, 959, 967, 1186

INDEX OF BATCHES CONTAINING ILLUSTRATED POTTERY
SITE A

Batch	Joining Batches	Year	Level	Provenance	Pot Numbers
A 337		1965	A 2	Room 37	199, 248
A 340		1965	A LA	Room 43 Fill above Level 1	1139
A 342	352	1965	A 2a-b	Room 16	573, 682
A 343	336	1965	A 2a-b	Room 24	679
A 345	346	1965	A 2c	Room 45	692, 747
A 346	345	1965	A 2c	Room 45	693, 694, 747, 748
A 348		1965	A 2c	Room III	675
A 352	342, 20	1965	A 2a-b	Room 3	17, 81, 101, 131, 191, 572, 662, 682, 938, 987, 988 + TR 2129
A 353		1965	A 1	Room 3 Fill	192, 1219
A 357		1965	A 1	Room 15 Fill	200
A 358		1965	A 3	Room XIII	355
A 361		1965	A 3	Room XV	893
A 363		1965	A 3 late	Room III	818
A 364		1965	A 3 late	Room III	611, 887
A 376		1965	A 2c	Room 45	829
A 380		1965	A 3	Room XV	825, 828
A 388		1965	A 3	Outside East Gate	236
A 389		1965	Mixed		686
A 395		1965	A 3 late	North of East Gate	375
A 400		1966	A 1	Courtyard	944
A 401		1966	A 1	Courtyard	10, 11, 12, 119, 478
A 402		1966	A 1	Courtyard floor with tablets	1238
A 403		1966	A 3-4	Room XXIV Fill	559
A 404		1966	A 3-4	Room XXIV Fill	555
A 406	408, 411	1966	2c-3	Room XIX	201, 279, 796, 1062
A 407		1966	A 2	Room 46	509, 1158
A 408	406, 411	1966	A 3 late	Room XIX	321, 449, 1062
A 409	411, 412, 413	1966	A 3 late	Room XIX	613, 1039
A 410		1966	A 4	Room XXIV Fill	563
A 411	406, 408, 409, 412, 413	1966	A 3 late	Room XIX	613, 1039, 1062
A 412	409, 411, 413	1966	A 3 late	Room XIX	234, 613, 830, 1039
A 413	409, 411, 412	1966	A 3	Room XIX	443, 445, 1039
A 416		1966	A LA	Ziggurat northeast corner	1135
A 419		1966	A 3	Room XIX	767, 1032
A 424		1966	Topsoil	Room 11	974
A 426		1966	A 2c	Room 11	143, 354
A 427		1966	A 2c	Room 11	388, 1023
A 434	585, 586	1966	A 3 late	Room XI	872
A 437		1966	A 2c	Outside East Gate	707
A 446		1966	A 2c-3	Room VIII Floors	806, 1216
A 449	452	1966	A 3 late	Room VIII	258, 628, 1212
A 452	449	1966	A 3 late	Room VIII	230, 448, 610, 628, 1035
A 453		1966	A 3	Outside South Gate. Fill	564
A 454		1966	A 3 late	Room VIII	362
A 455		1966	A 2	Room 19	657, 778, 1075
A 457		1966	A 2c	Outside South Gate	136
A 459		1966	A 2c	Outside South Gate	883
A 461		1966	A 1	Room 19 Fill above Level 2	44, 735, 942, 1116
A 462	498	1966	A 3 late	Room VIII Floor	218, 512
A 463		1966	A 3 late	Room 47/XVII	320, 1013, 1024, 1034, 1090, 1178

INDEX OF BATCHES CONTAINING ILLUSTRATED POTTERY
SITE A

Batch	Joining Batches	Year	Level	Provenance	Pot Numbers
A 465		1966	A 3	Ziggurat southwest corner, floor	807, 1127, 1168
A 468		1966	A 1	Courtyard	59
A 469		1966	Mixed		882
A 471		1966	A 2	Room 48	127, 202
A 473	487, 489	1966	A 1	Courtyard	95, 96, 122, 125, 154, 155, 157, 159, 178, 510, 571, 597, 857, 1053, 1060, 1192, 1231
A 474		1966	A 1	Courtyard	181, 660
A 477		1966	A 3 late	Room VIII	195, 245
A 478		1966	A 1	Courtyard Fill	394, 640
A 480	482	1966	A 3 late	Room VIII	465, 1063, 1102
A 481		1966	A 2a	Room 50	19 + TR 3325
A 482	480, 483	1966	A 3 late	Room VIII	393, 465, 672, 890, 1089
A 483	482	1966	A 3 late	Courtyard	393
A 484		1966	A 3	Room VIII	212, 322, 595, 596, 909, 911
A 487	473	1966	A 1	Courtyard Fill	123, 194, 1053, 1055
A 488		1966	A 1	Courtyard Fill	643
A 489	473	1966	A 1c-2a	Courtyard	96, 680
A 490		1966	A 2a	Courtyard	175, 1118
A 491		1966	A 3	Room VIII	915
A 492	493	1966	A 3	Room VIII Floor	396, 418, 447
A 493	492	1966	A 3	Room VIII Floor	396, 418
A 497		1966	A 3	Courtyard	349, 919
A 498	462	1966	A 3	Room VIII	241, 456, 512, 839
A 499		1966	Mixed		1074
A 500		1966	A 3	Room IV under vault	836
A 551		1967	A 3 late	Room XXV Floor 1	110, 112, 232
A 552		1967	A 3	Room XXV Floor 2	421, 906
A 553		1967	A 3	Room XXV Floor 3	757, 804
A 554	555, 556, 565	1967	A 3	Room XXV Floor 4 destruction level	1048
A 555	554, 556, 565	1967	A 3	Room XXV Floor 5 destruction level	617, 1048, 1059, 1151
A 556	555, 554, 565	1967	A 3	Room XXV Floor 6	226, 617, 753, 1015, 1151
A 558		1967	Topsoil	Room II	821
A 563		1967	A 2	Fill above North Gate	576, 820
A 565	555, 554, 556	1967	A 3	Room II destruction level with tablets	214, 217, 229, 256, 262, 280, 286, 288, 290, 301, 370, 471, 474, 475, 517, 560, 562, 620, 627, 779, 832, 898, 902, 907, 1020, 1059, 1093, 1129, 1183, 1203, 1222, 1224
A 568		1967	A 3	Room XXVI Floor 3	233, 398
A 569		1967	A 3	Room XXVI Floor 4	397, 407
A 570		1967	A 2c	Room XXVI Pit	254, 405, 1117
A 571		1967	A 3	Room XXVI Floor 5	374
A 572		1967	A 3 late	Room II Upper fill	912
A 573		1967	A 3	Room XVII Floor 2 and above	1037
A 574		1967	A 3	Room XVII Fill	406
A 577		1967	A 3	Room XXVI Fill Floor 2	791
A 578		1967	A LA	West of North Gate. Fill	1138
A 581		1967	A 3	Room XVII Floor 2	614, 615, 755
A 582		1967	A 3	North Gate Floor 1	823
A 583		1967	A 3	North Gate Floor 2	800
A 584		1967	A 3	North Gate destruction level	261, 269, 336, 404, 414, 876, 1084
A 585	434, 586	1967	A 3	Room XVII Floor 3	400, 462, 464, 872, 935
A 586	434, 585	1967	A 3	Room XVII Fill between Floors 2 + 3	872

INDEX OF BATCHES CONTAINING ILLUSTRATED POTTERY
SITE A

Batch	Joining Batches	Year	Level	Provenience	Pot Numbers
A 587		1967	A 3	Room XVII Fill between Floors 3 + 4	401, 1088
A 588		1967	A 3	Room XVII Floor 4 with tablets	335
A 589		1967	A 3	Under east ramp, East of Temple	965
A 590		1967	A 3 late	Room V Upper fill	399, 419, 802
A 592		1967	A LA	Late Assyrian Shrine	477, 495, 948, 1137, 1173, 1174, 1175, 1214
A 593		1967	A 3	Room II	297, 365
A 594		1967	A 3	Room V Lower fill	1180
A 595		1967	A 3	Room XVII lowest Floor	556
A 597		1967	A 3	Room V Lower fill	822
A 599	706, 709	1967	A 3	Room IV latest phase 3 Floor	219, 239, 240, 253, 277, 351, 363, 379, 384, 385, 395, 402, 408, 409, 410, 423, 453, 773, 777, 794, 805, 831, 871, 877, 903, 1061
A 600		1967	A 3	South of East Staircase with tablets	289, 307, 774
A 601		1967	A 3	Room XXV Floor 8	378, 885
A 602		1968	A 4	Shepherds' Caves (AS)	551
A 604		1968	A 4	AS 1 Phase 3	523, 766, 1041
A 605		1968	A 4	AS 1 Phase 3 Floor	566, 1017
A 606	609	1968	A 4	AS 1 Fill Phase 3	896
A 608	609	1968	A 4	AS 1 Phase 3	521
A 609	606, 608	1968	A 5	AS 8 Phase 2-3 mixed	521, 896
A 610		1968	A 4	AS 1 Phase 3	1103, 1206
A 611		1968	A 3	South face of Temple	215, 905
A 612		1968	Unstrat.	South side of Temple	776
A 613		1968	A 3	Southeast of Temple	246
A 614		1968	A 3	Southeast corner of Temple	211
A 615		1968	A 3-4	Pavement, at edge of mound, above AS 1	625, 1040
A 618		1968	A 3	Southeast corner of Temple	878
A 619		1968	A 2	Southeast corner of Temple	115, 134
A 621		1968	Unstrat.	Fill above vaulted building	916
A 624	628	1968	A 3	South of Temple Burnt debris	561, 1181
A 628	624	1968	A 3	South of Temple Burnt fill	1181
A 629		1968	A 3	South of Temple In drain	798
A 630		1968	A 4	AS Phase 3	880, 1064
A 631		1968	A 4	AS 1 Phase 3	237, 1051
A 632		1968	A 3	Southwest of AS 1 Stone floor	838
A 633		1968	A 3	Stone steps Upper fill	340
A 634		1968	A 4	Below black floor batch 631	540, 541, 542, 764
A 636		1968	A 4	AS 7 Phase 3	545
A 637		1968	A 3	East of Stone steps Fill	265, 266, 364
A 640		1968	A 3	Above upper floor, AS 2	895
A 641		1968	A 3	East of AS 1 Upper floor	1026
A 644		1968	A 4	Area AS, mixed deposit	1217
A 646		1968	A 3	Upper fill	251
A 650		1968	A 4	AS 4 Upper fill	544, 875
A 651		1968	A 4	AS 4 In oven	543
A 652		1968	A 3	Stone steps of Temple Burnt fill	473
A 653		1968	A 4-5	AS 8, Fill above batch 663	914
A 657		1968	A 4-5	AS 3 mixed deposit	1119
A 663		1968	A 6	AS phase 1	524, 533

INDEX OF BATCHES CONTAINING ILLUSTRATED POTTERY
SITE A

Batch	Joining Batches	Year	Level	Provenance	Pot Numbers
A 667		1968	A 3	AS Upper fill	1163
A 669		1968	A 3	AS 6 Upper fill	891
A 670		1968	A 3	Stone terrace Lower fill	371, 537
A 671		1968	A 4	AS 3 Phase 3 Floor	550, 1104, 1164
A 675		1968	A 4	AS 4 Phase 3 Floor	1100
A 677		1968	A 5	AS 11 Phase 2	525
A 682		1968	Topsoil	Islamic/Sassanian pit	969, 970, 971, 975
A 685		1968	A 5	AS 9 Phase 2	536
A 692		1968	A 4	AS 5 Phase 3 Fill	530
A 694		1968	A 5	AS 7 Phase 2 Fill	526
A 695		1968	A 3	East terrace Fill	331
A 700		1968	A 5	AS 9 Phase 2 Floor	531
A 701		1968	A 4	AS 5 Phase 3 Floor	522, 1098
A 702	718	1968	A 5	AS Phase 2 construction level	527, 529, 534, 535, 539, 546, 548, 553, 1101
A 705		1968	A 3	Room V Floor 2	450, 451, 913
A 706	599, 709	1968	A 3	Room IV Floor 2	871, 877
A 707		1968	A 3	Above pavement on edge of mound	558
A 708		1968	A 4	AS Phase 3	621
A 709	599, 706	1968	A 3	Room IV Floor 3	367, 565, 629, 877, 884, 910, 565
A 715		1968	A 3	Above AS 1	282
A 718	702	1968	A 5	AS Phase 2 construction level	528, 529
A 719		1968	A 3	Below drain	249, 565
A 720		1968	A 3 late	South of temple, mixed	292, 389, 390, 827
A 722		1968	A 5	AG 3-68 Grave AS Phase 2	547
A 723		1968	A 3	East face of Temple, fill above tablets	368
A 726		1968	A 3	Mixed	310
A 727		1968	A 6	AS Phase 1	532, 538, 554, 1099, 1134
A 728		1968	A 3	East face of Temple	772
A 732		1968	A 6	AS Phase 1 below batch 727	552
A 735		1968	A 3	Above terrace walls outside temple	196, 227, 250, 317, 775
A 737		1968	A 3	Next to terrace walls, lower fill	294, 372
A 739		1968	A 3	Pavement next to terrace wall	515

INDEX OF BATCHES CONTAINING ILLUSTRATED POTTERY
SITE C

Batch	Joining Batches	Year	Level	Provenance	Pot Numbers
C 1		1967	C 4	Room 43 Shrine floor	152
C 3		1967	C 2-3		622
C 14		1967	C 5	Room 55 Upper floor	220
C 17		1967	C 4	Room 43 Shrine destruction level	100
C 20	29	1967	C 6a	Room 59	514, 866
C 22		1967	C 5a	Below shrine room 43	1172
C 25	55	1967	C 4	Room 43 Shrine	107
C 28		1967	C 5b/6a	Room 59 Lower destruction level	264, 323, 373
C 29	20	1967	C 5b/6a	Room 59 Lower destruction level	326, 337, 344, 352, 358, 514, 797, 908
C 30		1967	C 6a	Second grey ash level	392
C 33		1967	C 6	Palace room I Floor 1	1036
C 34		1967	C 5b	Room 61 Lower floor	342
C 36		1967	C 6a	Second grey ash level above Palace room I	213
C 38		1967	C 5	West end of site	1058
C 42		1967	C 6	Palace room II Floor with tablets	416
C 43		1967	C 5b	Fill above Palace room I	799
C 46		1967	C 6	Palace room II Floor with tablets	235, 306, 403
C 48	77	1967	C 5	Fill north of courtyard	209, 210, 591, 665, 749, 1057
C 52		1967	C 6	Palace room IV	300, 305, 458, 549, 760
C 55	25	1967	C 4	Room 43 Upper floor	107, 1113
C 58		1967	C 3	Room 72 Fill	124, 190
C 62		1967	C 6	Palace courtyard III Fill	558
C 66		1967	C 1	North extension	2
C 67		1967	C 5a	Rooms 80, 81 Upper floor	508
C 68		1967	C 4	Floor above room 85	1133
C 75		1967	C 4	Room 83 Fill	736
C 76		1967	C 5	Above Palace room VII east	1194
C 77	48	1967	C 6a	Below room 80 Fill	302, 356, 793, 835, 1057
C 78		1967	C 6	Palace room VI with tablets	238, 293, 298, 299, 303, 304, 309, 311, 466, 759, 761, 1044
C 80		1967	C 5b	Room 85 Lower fill	1196
C 81		1967	C 3	Room 100	140, 203
C 82		1967	C 5b	Room 100 Lower level	268
C 83		1967	C 5b	Room 100 Lower floor	518, 1165
C 85		1967	C 6a	Room 100 Fill below Level 5	833
C 86		1967	C 5b	Room 101 Lowest floor	313
C 87		1967	C 6	Palace room X Fill	463, 881
C 89		1968	C 1	Area 101 Upper level	845
C 97		1968	C 1	Area 104 Fill	847
C 98		1968	C 1	Area 103 Floor of house	485
C 104		1968	C 1	Area 105 Floor	600
C 107		1968	C 1-2	Area 4 Fill	1229
C 110		1968	C 1-2	Area 3 Fill	928
C 111		1968	Surface		842, 943
C 117		1968	C 1	Mixed LA and MA	725
C 125		1968	C 1	Area 107 Upper fill	714
C 156		1968	C 1	Area 108 CG 2-68 Grave	476
C 165		1968	C 1	Area 15	493
C 168		1968	C 1	Area 15 Floor	850
C 173		1968	C 1	Area 15 Floor	479
C 181		1968	C 1	Area 11 Floor	925

INDEX OF BATCHES CONTAINING ILLUSTRATED POTTERY
SITE C

Batch	Joining Batches	Year	Level	Provenance	Pot Numbers
C 183		1968	C 3	Area 112 Fill	TR 5006
C 184	504	1968	C 1	Area 10 Floor, upper phase	497, 504
C 186		1968	C 1	Area 10 Over wall	841
C 187		1968	C 1	Area 15 Cut in north wall	599
C 189		1968	C 1	Area 11 Fill	480
C 197	210	1968	C 3	Area 113 Fill	1208
C 198		1968	C 1	Area 22 Fill, earliest LA	505, 927
C 200		1968	C 1	Area 14 CG 5-68 Grave	601, 602, 603
C 208		1968	C 1	Areas 10-13 To pavement	489
C 209		1968	C 2	Area 14 Floor	156
C 210	197	1968	C 3	Area 9 Fill above Level 3 floor	1208
C 213		1968	C 1	Area 103 Floor	1136
C 219		1968	C 1	Area 14 CG 8-68 Grave	492
C 220		1968	C 3-4	Destruction level	1177
C 222		1968	C 2-3	Area 103 Floor	968
C 223		1968	C 2	Area 15 Floor	64, 585
C 225		1968	C 3	Area 9 Fill	1210
C 226		1968	C 2	East of Area 14-16 Floor	165
C 227		1968	C 2	Area 8 Floor	952
C 230		1968	C 3	Small room	852
C 234		1968	C 1	Area 14 CG 10-68 Grave	982
C 237		1968	C 1	Area 17 CG 11-68 Grave	984
C 244		1968	C 5a	Area 9 Below shrine wall	147
C 247		1968	C 3	Area 15 Below pavement	1002 + TR 5018
C 248	270	1968	C 3	Area 16 (Glass hoard)	106, 592
C 249		1968	C 4	Area 105-110 Fill	1160
C 254		1968	C 2-3	Area 3, 4 Fill	484
C 258		1968	C 1	Area 1, 2 Below wall	486
C 265		1968	C 4	Area 104 Removal of wall	TR 5019
C 266		1968	C 2	Area 8 Within walls	142, 709
C 270	248	1968	C 3	Area 16 Below pavement	106, 592
C 272		1968	C 2	Area 8 Floor	652
C 277		1968	C 3	Northwest area	684
C 283		1968	C 4	Areas 1, 2, 7	711
C 288		1968	C 3	Area a Below pavement	918
C 302		1968	C 4	Area 104	149
C 308		1968	C 1	Area 15 CG 13-68 Grave	950
C 312		1968	C 4	Area 3	616
C 317		1968	C 5	Area 3 Floor	1094
C 319	320, 329, 677	1968	C 4	Area 106 Courtyard floor	1130, 1131, 1132
C 320	319, 329, 677	1968	C 4	Area 106 Courtyard floor	TR 5031, TR 5032, TR 5034, TR 5037, TR 5038, TR 5039, TR 5040
C 323		1968	C 5	Area 4 Shrine fill	917
C 326		1968	C 5	Area 3 Fill	126
C 329	319, 320	1968	C 4	Area 106 Courtyard floor	TR 5042
C 334		1968	C 6	Palace room I Floor	312
C 335		1968	C 5b	Area a Below Level 4 walls	150, 1201
C 344		1968	C 7	Palace room I Slit in floor	252, 291
C 345	347	1968	C 6a	Floor below Level 5 walls	285
C 346		1968	C 5	Area 3 Fill	1204
C 347	345	1968	C 6a	Area 3 Lower floor with tablet	285
C 348		1968	C 4	Baulk	605
C 349		1968	C 5b	Area 103 Floor, destruction level	224, 243, 1182
C 350		1968	C 5	Areas 3, 8 Upper floor	667
C 354		1968	C 4	Area 5 Two small rooms	590
C 358		1968	C 4	Area 21, 22 Square storage bin	855

INDEX OF BATCHES CONTAINING ILLUSTRATED POTTERY
SITE C

Batch	Joining Batches	Year	Level	Provenance	Pot Numbers
C 359		1968	C 4	Area 16 Fill	204
C 360		1968	C 5a	Area 16 Upper floor	316
C 361		1968	C 5	Northwest area Fill	341
C 368		1968	C 6a	Northwest area Fill to top of Palace walls	327
C 369		1968	C 6a	Area 104 Northwest area Fill	244, 259, 329, 334, 339, 790
C 370		1968	C 5a	Area 103 Fill and upper floor	242, 668
C 372		1968	C 5b	Area 3 Fill below Level 4 walls	206, 330, 345, 699
C 378		1968	C 5b	Area 101 Lower fill	338, 357, 359, 380, 382, 434, 440, 441
C 379		1968	C 5	Area a Fill and floor	387, 642
C 380		1968	C 5b	Areas 8, 16 Floor	863
C 382		1968	C 5b	Area 106 Lower fill	386, 391
C 383		1968	C 5b	Shrine building level	346
C 384		1968	C 5b	Area 15 Fill and floor	1014
C 385		1968	C 5a	Northwest area Upper level	415
C 391		1968	C 6a	Area 9 Below shrine	1223
C 392		1968	C 6	Area 3 Fill	318, 348
C 395	440, 444, 445	1968	C 6	Area a Next to north wall of Palace room XVI, with wine tablets	420, 425, 428, 459, 765, 1042, 1043, 1045, 1046, 1047, 1049, 1050, 1218
C 396		1968	C 5b	Area 2 Lower floor	677, 868
C 398		1968	C 5	Area 23 Fill	658
C 401		1968	C 5	Area 23 Below floor 1	381
C 403		1968	C 6a	Area 9 Above Palace	333, 756
C 404		1968	C 6a	Area 3 Lower fill	624, 746
C 406		1968	C 6a	Areas 21, 22 Fill	314
C 408		1968	C 6	Palace room XII Fill	557
C 410		1968	C 6a	Above Palace room II	789
C 411		1968	C 6	Palace room XIV Fill	260, 332, 347, 366
C 414		1968	C 6a	Area 14 Below Level 5b pavement	296, 315, 369
C 419		1968	C 6 a	Palace room II Upper fill	275
C 420		1968	C 6	Palace room XIV Fill	516
C 421		1968	C 6	Palace room XV Fill	377
C 431		1968	C 6a	Above Palace room XIV west	840
C 435		1968	C 6a	Cut into Palace room XIII	257
C 438		1968	C 6	Palace room XV Floor	1038
C 440	395	1968	C 6	Area a North of Palace room XVI (tablets)	1046
C 442		1968	C 6	Palace room II Floor (tablets)	985, 1018
C 444	395	1968	C 6	Area a North of Palace room XVI (tablets)	765
C 445	395	1968	C 6	Area a North of Palace room XVI (tablets)	287, 430, 457, 461, 673, 758, 770, 771
C 459		1968	C 7	Below Palace room XV	879
C 476		1968	C 7	Below Palace room IX	520
C 504	184	1971	C 1	Area Cn I Upper floor	483, 496, 504, 706
C 507		1971	C 1	Area Cn II	923
C 509		1971	C 1	Area Cn I "kitchen complex"	502
C 512		1971	C 1-2	Area Cn I	15
C 514	519, 521, 531	1971	C 3	Area Cn II Room D	955
C 516		1971	C 2	Area Cn I "kitchen complex"	174
C 517		1971	C 3	Area Cn II Room A	995
C 519	514, 521, 531	1971	C 3	Area Cn II Room B	955
C 520		1971	C 3	Area Cn II Room G	1072
C 521	514, 519, 531	1971	C 3	Area Cn II Room E	955
C 524		1971	C 4	Area Cn I	1007, 1110

INDEX OF BATCHES CONTAINING ILLUSTRATED POTTERY
SITE C

Batch	Joining Batches	Year	Level	Provenance	Pot Numbers
C 525		1971	C 4	Area Cn I	113, 586, 646
C 529		1971	C 3	Area Cn II Room D	47
C 531	514, 519, 521	1971	C 3	Area Cn II Room D	128, 139, 780, 955
C 532		1971	C 4	Area Cn II Room B	129, 133
C 535		1971	C 3	Area Cn II Room G	1153
C 537		1971	C 5	Area Cn I Upper Level 5	704
C 539	569	1971	C 5	Area Cn I	1092
C 540		1971	C 5	Area Cn I	900
C 542		1971	C 5b	Area Cn I CG 3-71 Grave, lower Level 5	994
C 544		1971	C 6a	Area Cn I	745
C 546		1971	C 5b	Area Cn I Removal of walls	197
C 549		1971	C 6a	Area Cn I Sump level	1170
C 553		1971	C 6	Area Cn I Palace Room XXI Fill and floor	422
C 557		1971	Mixed	Area Cn II Baulk removal	981, 991, 997
C 561		1971	C 7	Area Cn I Fill below Palace floor	267, 1052
C 568		1971	C 5	Area Cn I Upper Level 5	752,
C 569		1971	C 5	Area Cn I Upper Level 5	623, 1087 1092
C 574		1971	C 5	Area Cn II Room D	145, 1205
C 576		1971	C 5	Area Cn I Room F	678
C 578		1971	C 5	Area Cn I Removal of walls	87, 783
C 581		1971	C 6a	Area Cn I Sump	788
C 586		1971	C 5	Area Cn II Between room A and baulk	413
C 589		1971	C 6a	Area Cn I Sump	865
C 591		1971	C 5	Area Cn II Room A	1202
C 594		1971	C 6a	Area Cn II Under sump	1225
C 597		1971	C 6a	Area Cn I Over sump	608
C 601		1971	C 1-2	Area Cw I	481
C 602		1971	Topsoil	Area Cw III	482
C 605		1971	C 4-5	Area Cw I Mixed	717
C 614		1971	Topsoil	Area Cw IV	499
C 615		1971	C 1	Area Cw III	494
C 617		1971	C 3-4	Area Cw I	606, 607
C 624	627	1971	C 4-5	Area Cw I	148, 180
C 627	624	1971	C 4-5	Area Cw I	1236
C 631		1971	C 1	Area Cw II CG 4-71 Grave	88
C 640		1971	C 4	Area Cw I	589
C 646		1971	C 5	Area Cw II	1144
C 647		1971	C 5	Area Cw I Floor	584
C 649		1971	C 4	Area Cw IV Floor	105, 580, 739, 853, 960
C 650		1971	C 1	Area Cw III Late Assyrian drain	1176
C 651		1971	C 5	Area Cw I	958
C 652		1971	C 5	Area Cw I Floor	594, 740, 744
C 657		1971	C 5	Area Cw I	1152
C 658		1971	C 4	Area Cw III	647
C 661		1971	C 5	Area Cw I	663
C 669		1971	C 4	Area Cw IV North, floor	604
C 670		1971	C 5	Area Cw III Floor	612, 990, 1141, 1142, 1146, 1147
C 673	674, 679, 686, 696	1971	C 6a	Area Cw I Fill above "kitchen"	632, 1029
C 674	673, 679, 686, 696	1971	C 6a	Area Cw I Fill above "kitchen"	216, 271, 281, 813, 826, 1029 + TR 6020
C 676		1971	C 6a	Area Cw I	247, 376, 1125, 1126, 1128, 1195

INDEX OF BATCHES CONTAINING ILLUSTRATED POTTERY

SITE C

Batch	Joining Batches	Year	Level	Provenance	Pot Numbers
C 677	688	1971	C 5	Area Cw III Courtyard floor	83, 581, 957, 993, 1010, 1105, 1107, 1109, 1148 + TR 6049, TR 6050, TR 6051, TR 6052, TR 6053, TR 6054, TR 6055, TR 6056, TR 6057, TR 6058, TR 6059
C 679	673, 674, 686, 696	1971	C 6a	Area Cw I Fill of "kitchen"	216, 255, 271, 273, 281, 455, 469, 824, 1029, 1167, 1233
C 683		1971	C 4-5	Area Cw IV	716
C 685		1971	C 5b	Area Cw I Pit, lower Level 5	432
C 686	673, 674, 679, 696	1971	C 6a	Area Cw I Floor of "kitchen"	216, 255, 273, 276, 281, 412, 435, 436, 438, 452, 468, 519, 618, 626, 630, 631, 632, 784, 785, 801, 803, 810, 811, 812, 814, 816, 817, 824, 1021, 1022, 1025, 1028, 1031, 1096
C 688	677	1971	C 5	Area Cw III Courtyard floor	84, 1106, 1108, 1109 + TR 6061
C 689		1971	C 6a	Area Cw I	319
C 692		1971	C 5	Area Cw IV	179, 593
C 696	673, 674, 679, 686	1971	C 6a	Area Cw I Below floor of "kitchen"	278, 467, 815, 1011, 1030, 1156
C 697		1971	C 6	Area Cw I Palace fill	582, 787
C 698		1971	C 5	Area Cw III	208
C 699		1971	C 5b	Area Cw III Floor, lower Level 5	274
C 702		1971	C 4	Area Ce I and II	507
C 705		1971	C 4	Area Ce I and II	661
C 706	712, 713, 731	1971	C 4	Area Ce I and II	743, 860, 1009
C 710		1971	C 5	Area Ce I and II	689
C 712	706, 713, 731	1971	C 4	Area Ce I and II	860, 1009
C 713	706, 712, 731	1971	C 4	Area Ce I and II	1009, 1191
C 714		1971	C 1-2	Area Ce I and II	926
C 717	718	1971	C 1-2	Area Ce I and II	27
C 718	717	1971	C 1-2	Area Ce I and II	27, 62, 283
C 721		1971	Topsoil	Area Ce I and II	1235
C 725		1971	C 2	Area Ce I and II	1227
C 726		1971	C 4	Area Ce I and II	42
C 728		1971	C 4	Area Ce I and II	1081
C 731	706, 712, 713	1971	C 4	Area Ce I and II	860
C 732		1971	C 4	Area Ce I and II	506
C 734		1971	C 5	Area Ce I and II	1083
C 747		1971	C 5b	Area Ce I and II	636, 696, 697, 713
C 749		1971	C 4	Area Ce I and II	996, 1005
C 801	805	1971	C 6	Area Cn II Palace Floor	429, 674
C 803		1971	C 5	Area Cn II CG 11-71 Grave	741
C 805	801	1971	C 6	Area Cn II Palace Floor	674
C 806		1971	C 4-5	Area Cn III	676
C 808		1971	C 6	Area Cn II Palace Fill and floor	426, 460, 671, 762, 763, 768
C 813		1971	C 7	Area Cn II Beneath Palace Floor	427
C 900		1971	C 5b	Area Cw IV Lower Level 5	160
C 903		1971	Mixed	Area Cw III	85, 91
C 905		1971	C 5	Area Cw III	164, 446 + TR 6064
C 907		1971	C 5b	Area Cw II Lower Level 5	738
C 909		1971	C 6	Area Cw I Palace Floor	619
C 915		1971	C 4	Area Cw IV	846
C 916		1971	C 5	Area Cw V South	698
C 919		1971	C 6	Area Cw I Palace Fill and floor	904
C 920		1971	C 6	Area Cw I Palace Fill and floor	361

INDEX OF BATCHES CONTAINING ILLUSTRATED POTTERY
SITE C

Batch	Joining Batches	Year	Level	Provenience	Pot Numbers
C 921		1971	C 5b	Area Cw II Lower Level 5	1239
C 925		1971	C 6a	Area Cw II	433
C 926		1971	Topsoil	Area Cw VI	503
C 928		1971	C 6a	Area Cw III Sump level	272
C 933		1971	C 4	Area Cw IV	1161
C 934		1971	C 4-5	Area Cw IV	168
C 936		1971	C 5	Area CW IV Floor	1237
C 937		1971	C 4	Area Cw VI	574, 1027
C 939		1971	C 4-5	Area Cw IV	874
C 940		1971	C 4-5	Area Cw IV	207
C 942		1971	C 6a	Area Cw III Palace room XIX Pits	225
C 943		1971	C 4-5	Area Cw V North	721
C 944		1971	C 4-5	Area Cw VI Floor	862, 1004, 1006 + TR 6062
C 946		1971	C 6a	Area Cw III Palace room XIX Pits	1085
C 947	948	1971	C 6a	Area Cw IV Palace room XIV Pits	360, 1185
C 948	947	1971	C 6a	Area Cw IV Palace room XIV Pits	263, 353, 360, 442, 809
C 949		1971	C 1-4	Area Cw V South	141
C 950		1971	C 6a	Area Cw III Palace room XIII Pits	295, 328, 695, 782, 792, 808, 1166, 1169
C 951		1971	C 6	Area Cw III Palace room XIX Building level	411, 1097, 1162
C 953		1971	C 5	Area Cw VI Floor	1115 + TR 6063
C 954		1971	C 6a	Area Cw III Sump level	437
C 958		1971	C 6	Area Cw IV Palace room XIV Fill	1234
C 968		1971	C 6	Area Cw III Palace room XIII Building level	424, 889
C 1000		1971	C 6a	Area Cs I	1012
C 1001		1971	C 6a	Area Cs I	633
C 1006		1971	C 5	Area Cs II	609, 1209
C 1011		1971	C 5b	Area Cs II Early Level 5	1000
C 1015		1971	C 6	Area Cs II South of Palace room III	1179
C 1017		1971	C 6a	Area Cs II Above Palace room III	1095

INDEX OF BATCHES CONTAINING ILLUSTRATED POTTERY
SITE D

Batch	Joining Batches	Year	Level	Provenance	Pot Numbers
D 11		1966	D 1	Dc Islamic	973
D 28		1966	D 3	Db Fill between floors 4 and 5	193
D 33		1966	D 3	Dc Fill between floors 4 and 5	48, 69
D 36		1966	D 3	De Floor	892
D 47		1966	D 2	Dd Floor	946
D 49		1966	D 3	Dd Fill and floor	53
D 53		1966	D 3	Df Grave cut with large jar	36
D 57		1966	D 3	Di Fill	25
D 58		1966	D 3	Di Floor	999
D 59		1966	D 3	Di Floor	8
D 62		1966	D 3	Da Fill above floor	1086, 1220
D 65		1966	D 4	Da Floor	1003
D 69		1966	D 4	Di On pavement	732
D 82		1966	D 2		843
D 91		1966	D 3		205
D 93		1966	D 4	Dg	1189
D 96		1966	D 1	Islamic	972
D 97		1966	D 4		1215
D 105	110	1966	D 3		1230
D 106		1966	D 4		138, 182, 666
D 110	105	1966	D 3		1230
D 115		1966	D 4		700
D 119		1966	D 3		1228
D 122		1966	D 4		851
D 139		1966	D 3	Ds Fill in northeast corner of room	727
D 144		1966	D 4		284
D 147		1966	D 2		844
D 152		1966	D 4 ?		638
D 154		1966	D 3		41
D 162		1966	D 4		109

INDEX OF CATALOGUED POTTERY
1964

TR No	Pot No	Division	Museum No	Batch	Level	Provenance	Type
150	966	E		A 72 etc.	A 2a	Site A Cobbled street south of Room 7	Jug
151	940	P	UM 64111	C	Surface	Site C Fill above Level 1	Small jar
152	1077	E	BM 141458	C	C 3	Site C North area on floor	Strainer
153	870	P	UM 64112	C	C 5	Site C Sounding 1	Grain measure
154	989	E		A 20	A 2a-b	Site A Room 3 sunk into the floor	Jar
155	998	B	IM 69622	A	A 1	Site A Fill above Level 1	Jar
156	645	P	UM 64113	A 23	A 2	Site A Room 14 just below burnt floor	Deep bowl
157	937	B	IM 69623	A	A 2	Site A West of blocked doorway into Room 2	Small jar
158	930	B	IM 69579	A 81	A 1-2	Site A Room 19 over north wall of Level 2	Small jar
159	750	P	UM 64114	A	A 2	Site A Against outer face of north wall of Room 12	Beaker
160	947	B	IM 69624	A 72 etc.	A 2a	Site A Cobbled street south of Room 7	Small jar
161	~900	E	BM 141444	A 57	A 2a-b	Site A Room 7 on floor	Miniature cup
162	929	B	IM 69580	A 69	A 2b	Site A Room 5 beside oven	Small jar
163	920	B	IM 69581	A 69	A 2b	Site A Room 5 on floor	Miniature jar
164	651	B	IM 69625	A 17	A 1	Site A Room 2 on floor	Beaker
165	921	E	BM 141459	A 81	A 1-2	Site A Room 19 over north wall of Level 2	Miniature jar
166	171	E	AA 1968.33	A 72 etc.	A 2a	Site A Cobbled street south of Room 7	Bowl
167	992	B	IM 69595	A 41	A 2a-b	Site A Room 2 in floor	Jar
168	956	B	IM 69582	A	A 1	Site A Topsoil	Small jar
173	~1149	P	UM 64118	A 81	A 1-2	Site A Room 19 over north wall of Level 2	Potstand
174	~1147	B	IM 69626	A 55	A 2b	Site A Room 6 on floor	Potstand
175	1143	P	UM 64119	A 55	A 2b	Site A Room 6 on floor	Potstand
176	~1143	B	IM 69627	A 72 etc.	A 2a	Site A Cobbled street south of Room 7	Potstand
177	~1148	E	BM 141461	A	A 1	Site A Topsoil	Potstand
178	978	P	UM 64116	CG -64	C 3	Site C Room 3 Grave sunk into floor	Jar
179	1080	B	IM 69628	A	A 2	Site A Pavement outside Temple doorway	Strainer
180	1068	P	UM 641110	A	A 2	Site A Pavement outside Temple doorway	Strainer
181	~1190	B	IM 69578	A 72 etc.	A 2a	Site A Cobbled street south of Room 7	Pig pot
182	1079	B	IM 69629	A 55	A 2b	Site A Room 6 on floor	Strainer
183	941	B	IM 69583	A 61	A 1b	Site A Room 3 floor 3	Small jar
184	899	P	UM 64115	C	C 2	Site C Sounding 1	Miniature jar
185	1082	B	IM 69630	A 58	A 2-3	Site A Room 12 upper fill	Strainer
186	~953	E		A 72 etc.	A 2a	Site A Cobbled street south of Room 7	Jar
187	~1077	E	AA 1968.32	A 61	A 1b	Site A Room 3 floor 3	Strainer
189		London		A	Topsoil	Site A Topsoil above Temple Room XV	Sherds
190	644	B	IM 69631	A 61	A 1b	Site A Room 3 east end in fill between floors 1 and 2	Jar sherds
254		P	UM 652451	A 96	A 1	Site A Room 15	Sherd

Division:- From 1964 to 1968 all catalogued finds were allocated to one of the following:-
 B = Iraq Museum, Baghdad. E = British Expedition. P = University Museum, Pennsylvania.

Museum numbers are given where known:-

IM = Iraq Museum, Baghdad. BM = British Museum, London. UM = University Museum, Pennsylvania.
 AM = Ashmolean Musum, Oxford. AA = University Museum of Archaeology and Anthropology, Cambridge.

INDEX OF CATALOGUED POTTERY

1965

TR No	Pot No	Div	Museum No	Batch	Level	Provenience	Type
2100	97	P	UM 65241	A 62	A 2a-b	Site A Room 21 floor	Bowl
2101	1200	B	IM 69646	C	C 5	Site C Sounding 1	Tripod bowl
2102	931	E	BM 141462	A 72 etc.	A 2a	Site A Cobbled street south of Room 7	Small jar
2103	681	P	UM 65242	A 37	A 2c	Site A Room 12 fill above floor	Beaker
2104	795	B	IM for study	C	C 5	Site C Sounding 1 extension	Beaker
2105	653	E	AM '66.163-4	A 33	A 1c	Site A Courtyard fill	Beaker
2106	936	E	BM 141445	A 72 etc.	A 2a	Site A Cobbled street south of Room 7	Small jar
2107	~859	B	IM 69639			Unstratified	Grain measure
2108	1197	B	IM 128168	C	C 3	Site C North area section 2 on floor 3	Tripod jar
2109	858	E		A 32	A 2	Site A Rm 13 fill between floors 1 & 2	Grain measure
2110	669	B	IM 69640	C	C 3	Site C South trench 1	Beaker
2111	1069	B	IM 69641	C	C 3	Site C South trench 1	Strainer
2112	1076	E		C	C 3	Site C South trench 1	Strainer
2113	734	B	IM 69642	C	C 1	Site C Slope trench 2	Beaker
2114	191	B	IM for study	A 352	A 2a-b	Site A Room 3	Bowl
2115	511	E		A 284 etc.	A 1	Site A Room 37	Jar
2116	986	B	IM for study	A 274	A 2	Site A Room 42	Jar
2117	635	E		A 284	A 1	Site A Room 37	Deep bowl
2118	634	P	UM 65243	A 234	A 1	Site A Courtyard fill	Deep bowl
2119	1186	B	IM 69690	A 336	A 2a-b	Site A Room 24	Pig pot
2120	1190	E	BM 141484	C	C ?	Site C Slope trench 2	Pig pot
2121	962	B	IM 69691	A 307	A 2a-b	Site A Room 22	Small jar
2122	1154	B	IM 69643	C	C 3-4	Site C South trench 1 on floor	Potstand
2123	1155	E		C	C 3	Site C Slope trench 2	Potstand
2124	1150	B	IM 69644	C	C 2-3	Site C North of Rm 5 destruction level	Potstand
2125	954	E		A 336	A 2a-b	Site A Room 24	Small jar
2126	664	P	UM 65244	A 321	Topsoil	Site A Room 22 upper fill	Beaker
2127	679	E	AA 1968.27	A 336 etc.	A 2a-b	Site A Room 24	Beaker
2128	675	B	IM 69645	A 348	A 2c	Site A Room III	Beaker
2129	~857	P	UM 65245	A 352	A 2a-b	Site A Room 3	Grain measure
2130	964	B	IM 69647	C	C 2-3	Site C North of Room 5	Small jar
2131	1114	B	IM 69648	C	C 2-3	Site C North of Room 5	Potstand
2132	649	P	UM 65246	A 289	A 1	Site A Room 37 fill	Beaker
2133	1149	E		C	C 2-3	Site C Room 29 on floor	Potstand
2134	587	P	UM 65247	C	C 1	Site C Room 22 on floor	Bowl
2135	650	B	IM 69649	A 205	A LA	Site A Above Room 15	Beaker
2136	932	B	IM 69650	A 305	A 1	Site A Room 22 fill	Small jar
2137	938	B	IM 69651	A 352	A 2a-b	Site A Room 3	Small jar
2138	32	E	BM 141446	A 228	A 1b	Site A Courtyard	Bowl
2139	737	E		A 307	A 2a-b	Site A Room 22	Beaker
2140	221	B	IM for study	C	C 4	Site C Drain room	Bowl
2141	682	B	IM 69652	A 342 etc.	A 2a-b	Site A Room 16	Beaker
2142	933	B	IM 69653	A 310	A 2	Site A Room 16	Small jar
2143	963	P	UM 65248	A 307	A 2a-b	Site A Room 22	Small jar
2144	1193	B	IM 69654	A 291	A 2a-b	Site A Room 44	Model
2309		E	Cambridge	C	C 2	Site C Room 18	Ram's head
2603	~947	B	IM 69675	A 313	A 2c	Site A Outside East Gate	Glazed jar
2607	~948	B	IM 69677	C	C 1	Site C Room 41 Upper fill	Glazed jar
2608	1221	P	UM 652421	A 266	A 1	Site A Room 15	Glazed jug
2701		B	IM 69684	A 236+	A 1	Site A Courtyard	Glazed bowl
2745a		E	UM 652420	A 270	A 1	Site A Room 15	Glazed bowl
2745b		E	AA	A 270	A 1	Site A Room 15	Glazed bowl
2746		B	IM 69696	A 270+	A 1	Site A Room 15 and Courtyard	Glazed bowl

INDEX OF CATALOGUED POTTERY
1966

TR No	Pot No	Div	Museum No	Batch	Level	Provenance	Type
3100	89	P	UM 66171	DG 22-66	D 4	Site D Area Dd Grave 22	Bowl
3101	86	E		DG 22-66	D 4	Site D Area Dd Grave 22	Bowl
3102	90	B	IM 69701	DG 22-66	D 4	Site D Area Dd Grave 22	Bowl
3103	137	E		DG 22-66	D 4	Site D Area Dd Grave 22	Bowl
3104	848	B	IM 69702	DG 16-66	D 2	Site D Area Df Grave 16	Cup
3105	727	E		D 139	D 3	Site D Area Ds fill in northeast corner of room	Beaker
3106	1178	B	IM 69703	A 463	A 3 late	Site A Room 47 / XVII on floor	Stand
3107	1189	B	IM 69704	D 93	D 4	Site D Area Dg	Pig pot
3108	1192	P	UM 66172	A 473	A 1	Site A Courtyard	Model
3109	218	B	IM 69705	A 462	A 3 late	Site A Room VIII floor	Bowl
3110	735	B	IM 69706	A 461	A 1	Site A Room 19 fill above Level 2	Beaker
3111	806	P	UM 66173	A 446	A 2c-3	Site A Room VIII floors	Beaker
3112	945	P	UM 66174	DG 7-66	D 2	Site D Area Do Grave 7	Small jar
3113	639	P	UM 66175	DG 10-66	D 4	Site D Area Do Grave	Large beaker
3114	974	E	BM 141463	A 424	Topsoil	Site A Room 11	Jar
3115	1065	E	Cambridge		Surface		Strainer
3116	1075	B	IM 69707	A 455	A 2	Site A Room 19	Strainer
3117	1090	P	UM 66176	A 463	A 3 late	Site A Room 47 / XVII	Strainer
3118	1078	B	IM 69708	A	Topsoil	Site A South of east gate	Strainer
3119	949	B	IM 69709	DG 3-66	D 2	Site D Area Di Grave 3	Small jar
3120	1023	P	UM 66177	A 427	A 2c	Site A Room 11	Jar
3121	694	E		A 346	A 2c	Site A Room 45	Beaker
3122	680	E		A 489	A 1c-2a	Site A Courtyard	Bowl
3123	1135	B	IM 69710	A 416	A LA	Site A Ziggurat northeast corner	Potstand
3124	1055	B	IM 69711	A 487	A 1	Site A Courtyard fill	Deep bowl
3125	1124	B	IM for study	D	D 4	Site D Area Da	Potstand
3126	1116	B	IM for study	A 461	A 1	Site A Room 19 fill above Level 2	Potstand
3127	1127	E	BM 141470	A 465	A 3	Site A Ziggurat southwest corner, floor	Potstand
3128	1121	E	Cambridge	D	D 4	Site D Area Da	Potstand
3129	1123	P	UM 66179	D	D 4	Site D Area Da	Potstand
3130	~1120	B	IM 69712	D	D 4	Site D Area Da	Potstand
3131	1122	P	UM 661710	D	D 4	Site D Area Da	Potstand
3132	1120	B	IM 69713	D	D 4	Site D Area Da	Potstand
3133	1118	E	Cambridge	A 490	A 2a	Site A Courtyard	Potstand
3134	1157	B	IM 69714	A	A 1	Site A	Bowl
3135	1168	P	UM 661711	A 465	A 3	Site A Ziggurat southwest corner, floor	Stand
3136	396	P	UM 661712	A 492 etc.	A 3	Site A Room VIII floor	Bowl
3137	418	B	IM 69715	A 492 etc.	A 3	Site A Room VIII floor	Bowl
3138	922	B	IM 69716	D	D 1	Site D	Miniature bowl
3139	919	B	IM 69717	A 497	A 3	Site A Courtyard	Miniature cup
3140	167	B	IM 69718	A	A 2	Site A In plaster revetment of inscribed statue	Bowl
3141	807	B	IM 69719	A 465	A 3	Site A Ziggurat southwest corner, floor	Beaker
3325		E	BM 141485	A 481	A 2a	Site A Room 50	Sherds
3615		E	AM 1967.717	D	Topsoil	Site D Area Df Topsoil Pit	Glazed lamp

INDEX OF CATALOGUED POTTERY

1967

TR No	Pot No	Div	Museum No	Batch	Level	Provenance	Type
4100	781	B	IM 70514	C	C 3	Site C Room 1 northwest corner, set into wall	Beaker
4101	1213	B	IM 70534	B	B LA	Site B Late Assyrian house	Jar
4102	804	E	Cambridge	A 553	A 3	Site A Room XXV floor 3	Beaker
4103	729	B	IM 70517	A	A 3	Site A Room III East, fill immediately above grey layer	Beaker
4104	1184	B	IM 70537	A	A 3	Site A Room III East, fill immediately above grey layer	Stand
4105	~1114	B	IM 70532	C	C 4	Site C Room 50	Potstand
4106	1056	B	IM 70519	A 25	A 2c	Site A Room 14	Deep bowl
4107	16	B	IM for study	A	A 2a	Site A Upside-down on courtyard level in front of Lama relief, covered by plaster revetment	Bowl
4108	908	B	IM 70520	C 29	C 5	Site C Room 59 lower destruction level	Miniature jar
4109	755	E		A 581	A 3	Site A Room XVII floor 2, in southwest corner of room	Beaker
4110	264	E	BM 141464	C 28	C 5b/6a	Site C Room 59 lower destruction level	Bowl
4111	1129	E	BM 141475	A 565	A 3	Site A Room II	Potstand
4112	935	E	BM 141448	A 585	A 3	Site A Room XVII floor 3	Small jar
4113	615	E	BM 141468	A 581	A 3	Site A Room XVII floor 2, in southwest corner of room	Deep bowl
4114	614	B	IM for study	A 581	A 3	Site A Room XVII floor 2, in southwest corner of room	Deep bowl
4115	965	B	IM 70538	A 589	A 3	Site A Under east ramp, east of Temple	Small jar
4116	948	E		A 592	A LA	Site A Late Assyrian Shrine, against north wall of the ante-chamber	Small jar
4117	1137	E		A 592	A LA	Site A Late Assyrian Shrine, against north wall of the ante-chamber	Potstand
4118	419	E		A 590	A 3 late	Site A Room V upper fill	Bowl
4119	399	B	IM 70536	A 590	A 3 late	Site A Room V upper fill	Bowl
4120	1214	E	BM 141465	A 592	A LA	Site A Late Assyrian Shrine, in cella	Stand
4121	1180	B	IM 70531	A 594	A 3	Site A Room V fill against south wall, east of doorway	Stand
4122	1112	B	IM 70533	C	Topsoil	Site C west	Potstand
4123	769	E	Cambridge	A		Site A In angle between lower terrace & staircase walls	Beaker
4124	518	B	IM 70535	C 83	C 5b	Site C Room 100 lower floor	Bowl
4125	1165	E	BM 141473	C 83	C 5b	Site C Room 100 floor, on brick in middle of room	Stand
4126	902	E	AM 1970.96	A 565	A 3	Site A Room II floor	Miniature cup
4127	1175	B	IM for study	A 592	A LA	Site A Late Assyrian Shrine	Stand
4128	1173	B	IM 70539	A 592	A LA	Site A Late Assyrian Shrine	Stand
4129	1174	E		A 592	A LA	Site A Late Assyrian Shrine	Stand
4130	311	B	IM for study	C 78	C 6	Site C Palace Room VI in south corner of room	Bowl
4131	1183	E	BM 141477	A 565	A 3	Site A Room II floor	Stand
4132	~1056	E		A 47	A 2a	Site A Room 4	Deep bowl
4337	1194	B	IM for study	C 76	C 5	Site C Above Palace Room VII east	Mould

INDEX OF CATALOGUED POTTERY

1968

TR No	Pot No	Div	Museum No	Batch	Level	Provenance	Type
5000	905	B	IM 72586	A 611	A 2-4	Site A South face of Temple	Miniature jar
5001	928	E		C 110	C 1-2	Site C Area 3 fill	Small jar
5002	766	E	BM 141478	A 604	A 4	Site A AS 1 Phase 3	Beaker
5003	878	B	IM 72587	A 618	A 3	Site A Southeast corner of Temple	Grain measure
5004	927	B	IM 72623	C 198	C 1	Site C Area 22 fill, earliest LA	Small jar
5005	~495	B	IM 72624	CG 9-68	C 1	Site C Grave 9, child burial	Bowl
5006	~662	B	IM 72588	C 183	C 3	Site C Area 112 fill	Beaker
5007	914	E	BM 141450	A 653	A 4-5	Site A AS 8 fill	Miniature jar
5008	952	B	IM 72589	C 227	C 2	Site C Area 8 floor	Small jar
5009	1064	E	BM 141479	A 630	A 4	Site A AS Phase 3	Jar
5010	1229	B	IM 72608	C 107	C 1-2	Site C Area 4 fill	Lamp
5011	1217	B	IM 72590	A 644	A 4	Site A AS mixed deposit	Stand
5012	505	B	IM 72632	C 198	C 1	Site C Area 22 fill, earliest LA	Lugged bowl
5013	621	B	IM 72628	A 708	A 4	Site A AS Phase 3	Deep bowl
5014	493	E	BM 141451	C 165	C 1	Site C Area 15	Bowl
5015	1136	B	IM 72633	C 213	C 1	Site C Area 103 floor of rm, plastered bath	Potstand
5016	773	B	IM for study	A 599	A 3	Site A Room IV latest Phase 3 floor	Beaker
5017	913	E		A 705	A 3	Site A Room V floor 2	Miniature jar
5018	~1076	E		C 247	C 3	Site C Area 15 below pavement	Strainer
5019	~669	B	IM 72591	C 265	C 4	Site C Area 104 removal of Level 3 wall	Beaker
5020	969	B	IM 72634	A 682	Pit	Site A Islamic/Sassanian pit	Jar
5021	652	E	Cambridge	C 272	C 2	Site C Area 8 floor	Beaker
5022	165	E	BM 141452	C 226	C 2	Site C East of area 14-16 floor	Bowl
5023	156	B	IM 72625	C 209	C 2	Site C Area 14 floor	Bowl
5024	106	E		C 248 etc.	C 3	Site C Area 16 (with glass hoard)	Bowl
5025	950	B	IM 72629	CG 13-68	C 1	Site C Area 15 Grave 13	Small jar
5026	547	B	IM 72626	AG 3-68	A 5	Site A Grave 3, fill below domed building	Jar
5027	970	B	IM 72627	A 682	Pit	Site A Islamic/Sassanian pit	Jar
5028	975	E		A 682	Pit	Site A Islamic/Sassanian pit	Jar
5029	971	E		A 682	Pit	Site A Islamic/Sassanian pit	Jar
5030	1182	E	BM 141498	C 349	C 5b	Site C Area 103 floor, destruction level	Stand
5031	~1112	B	IM 72592	C 320	C 4	Site C Area 106 courtyard of house	Potstand
5032	~1132	B	IM 72593	C 320	C 4	Site C Area 106 courtyard of house	Potstand
5033	1132	E	Cambridge	C 319	C 4	Site C Northwest area courtyard of house	Potstand
5034	~1112	E	BM 141471	C 320	C 4	Site C Area 106 courtyard of house	Potstand
5035	1130	B	IM 72594	C 319	C 4	Site C Northwest area courtyard of house	Potstand
5036	1131	E	BM 141474	C 319	C 4	Site C Northwest area courtyard of house	Potstand
5037	~1112	E		C 320	C 4	Site C Area 106 courtyard of house	Potstand
5038	~1132	B	IM for study	C 320	C 4	Site C Area 106 courtyard of house	Potstand
5039	~1112	B	IM 72595	C 320	C 4	Site C Area 106 courtyard of house	Potstand
5040	~1129	E	Cambridge	C 320	C 4	Site C Area 106 courtyard of house	Potstand
5041	~1112	E	Cambridge	C	C 4	Site C South edge next to Level 3 wall	Potstand
5042	~1132	B	IM for study	C 329	C 4	Site C Area 106 courtyard of house	Potstand
5043	590	E	BM 88.4.10.46	C 354	C 4	Site C Area 5 two small rooms	Cooking pot
5044	285	E	Cambridge	C 345 etc.	C 6a	Site C Area 3 lower floor	Bowl
5045	428	E	BM 141453	C 395	C 6	Site C Area a next to Rm XVI, wine tablets	Lid
5046	746	B	IM 72596	C 404	C 6a	Site C Area 3 lower fill	Beaker
5047	789	E		C 410	C 6a	Site C Above Palace Room II	Beaker
5048	939	E	BM 141454	C	C 2-3	Site C Removal of wall	Small jar
5049	1218	B	IM 72597	C 395	C 6	Site C Area a next to Rm XVI, wine tablets	Cup
5050	420	E	BM 141455	C 395	C 6	Site C Area a next to Rm XVI, wine tablets	Bowl
5051	985	E	BM 141476	C 442	C 6	Site C Palace Room II on floor	Jar
5052	751	E	BM 141456	CG 17-68	C 5	Site C Grave 17, above Palace Room XVI	Beaker
5053	74	B	IM 72598	CG 17-68	C 5	Site C Grave 17, above Palace Room XVI	Bowl
5054	1103	B	IM 72599	A 610	A 4	Site A AS 1 Phase 3	Strainer
5055	1036	B	IM 78658	C 33	C 6	Site C Palace Room I floor	Jar with inscription
5710			IM for study				

INDEX OF CATALOGUED POTTERY

1971

TR No	Pot No	Museum No	Batch	Level	Provenance	Type
6000	612	IM 74736	C 670	C 5	Site C Area Cw III floor	Deep bowl
6001	1146	IM 74737	C 670	C 5	Site C Area Cw III floor	Potstand
6002	951	IM 74738	CG 5-71	C 1	Site C Grave 5 Late Assyrian adult burial	Small jar
6003	670	IM 74739	CG 10-71	C 1	Site C Grave 10 adult burial	Beaker
6004	741	IM 74740	CG 11-71	C 5	Site C Grave 11 child burial associated with Mitanni walls	Beaker
6005	88	IM 74741	CG 4-71	C 1	Site C Grave 4 adult burial	Bowl
6006	83	IM for study	C 677	C 5	Site C Area Cw III courtyard floor	Bowl
6007	740	IM for study	C 652	C 5	Site C Area Cw I floor	Beaker
6008	663	IM 74742	C 661	C 5	Site C Area Cw I	Beaker
6009	586	IM 74743	C 525	C 4	Site C Area Cn I	Bowl
6010	584	IM 74744	C 647	C 5	Site C Area Cw I floor	Bowl
6011	607	IM for study	C 617	C 3-4	Site C Area Cw I	Deep bowl
6012	606	IM for study	C 617	C 3-4	Site C Area Cw I	Deep bowl
6013	594	IM for study	C 652	C 5	Site C Area Cw I floor	Cooking pot
6014	1176	IM for study	C 650	C 1	Site C Area Cw III Late Assyrian drain	Drain pipe
6015	1092	IM 74745	C 539 etc.	C 5	Site C Area Cn I	Strainer
6016	1081	IM 74746	C 728	C 4	Site C Area Ce I and II	Strainer
6017	1202	IM 74747	C 591	C 5	Site C Area Cn II room A	Tripod bowl
6018	412	IM 128167	C 686	C 6a	Site C Area Cw I floor of kitchen	Bowl
6019	468	IM for study	C 686	C 6a	Site C Area Cw I floor of kitchen	Bowl
6020	~444	IM for study	C 674	C 6a	Site C Area Cw I fill above kitchen	Bowl
6021	435	IM for study	C 686	C 6a	Site C Area Cw I floor of kitchen	Bowl
6022	438	IM for study	C 686	C 6a	Site C Area Cw I floor of kitchen	Bowl
6023	519	IM 128166	C 686	C 6a	Site C Area Cw I floor of kitchen	Bowl
6024	1096	IM 74748	C 686	C 6a	Site C Area Cw I floor of kitchen	Strainer
6025	784	IM 74749	C 686	C 6a	Site C Area Cw I floor of kitchen	Beaker
6026	785	IM 74750	C 686	C 6a	Site C Area Cw I floor of kitchen	Beaker
6027	801	IM for study	C 686	C 6a	Site C Area Cw I floor of kitchen	Beaker
6028	811	IM for study	C 686	C 6a	Site C Area Cw I floor of kitchen	Beaker
6029	810	IM for study	C 686	C 6a	Site C Area Cw I floor of kitchen	Beaker
6030	814	IM for study	C 686	C 6a	Site C Area Cw I floor of kitchen	Beaker
6031	817	IM for study	C 686	C 6a	Site C Area Cw I floor of kitchen	Beaker
6032	816	IM 74751	C 686	C 6a	Site C Area Cw I floor of kitchen	Beaker
6033	812	IM for study	C 686	C 6a	Site C Area Cw I floor of kitchen	Beaker
6034	824	IM 74752	C 679 etc.	C 6a	Site C Area Cw I fill and floor of kitchen	Beaker
6035	618	IM for study	C 686	C 6a	Site C Area Cw I floor of kitchen	Deep bowl
6036	276	IM for study	C 686	C 6a	Site C Area Cw I floor of kitchen	Bowl
6037	1028	IM for study	C 686	C 6a	Site C Area Cw I floor of kitchen	Jar
6038	1030	IM for study	C 696	C 6a	Site C Area Cw I below floor of kitchen	Jar
6039	1025	IM for study	C 686	C 6a	Site C Area Cw I floor of kitchen	Jar
6040	1021	IM for study	C 686	C 6a	Site C Area Cw I floor of kitchen	Jar
6041	626	IM 127125	C 686	C 6a	Site C Area Cw I floor of kitchen	Deep bowl
6042	631	IM for study	C 686	C 6a	Site C Area Cw I floor of kitchen	Deep bowl
6043	632	IM for study	C 673 etc.	C 6a	Site C Area Cw I fill and floor of kitchen	Deep bowl
6044	630	IM for study	C 686	C 6a	Site C Area Cw I floor of kitchen	Deep bowl
6045	1233	IM for study	C 679	C 6a	Site C Area Cw I fill of kitchen	Lamp
6046	429	IM for study	C 801	C 6	Site C Area Cn II Palace floor	Lid
6047	904	IM for study	C 919	C 6	Site C Area Cw I Palace fill and floor	Miniature jar
6048	1000	IM for study	C 1011	C 5b	Site C Area Cs II early Level 5	Jar
6049	~1115	IM for study	C 677	C 5	Site C Area Cw III Courtyard floor	Potstand
6050	~1115	IM for study	C 677	C 5	Site C Area Cw III Courtyard floor	Potstand
6051	~1108	IM for study	C 677	C 5	Site C Area Cw III Courtyard floor	Potstand
6052	~1117	IM for study	C 677	C 5	Site C Area Cw III Courtyard floor	Potstand
6053	~1118	IM for study	C 677	C 5	Site C Area Cw III Courtyard floor	Potstand
6054	~1121	IM for study	C 677	C 5	Site C Area Cw III Courtyard floor	Potstand

INDEX OF CATALOGUED POTTERY
1971

TR No	Pot No	Museum No	Batch	Level	Provenance	Type
6055	~1117	IM for study	C 677	C 5	Site C Area Cw III Courtyard floor	Potstand
6056	~1117	IM for study	C 677	C 5	Site C Area Cw III Courtyard floor	Potstand
6057	~1117	IM for study	C 677	C 5	Site C Area Cw III Courtyard floor	Potstand
6058	~1118	IM 74753	C 677	C 5	Site C Area Cw III Courtyard floor	Potstand
6059	~1117	IM for study	C 677	C 5	Site C Area Cw III Courtyard floor	Potstand
6060	1105	IM for study	C 677	C 5	Site C Area Cw III Courtyard floor	Potstand
6061	~1131	IM for study	C 688	C 5	Site C Area Cw III Courtyard floor	Potstand
6062	~1131	IM for study	C 944	C 4-5	Site C Area Cw VI Adjoining room floor	Potstand
6063	~1106	IM 74754	C 953	C 5	Site C Area Cw VI Adjoining room floor	Potstand
6064	~1108	IM 74755	C 905	C 5	Site C Area Cw III	Potstand
6065	1128	IM for study	C 676	C 5b	Site C Area Cw I	Potstand
6066	991	IM 74756	C 557	Mixed	Site C Area Cn II Removal of baulk	Jar
6067	997	IM for study	C 557	Mixed	Site C Area Cn II Removal of baulk	Jar
6068	1019	IM for study	CG 17-71	C 5b	Site C Grave 17 Child burial	Jar
6311	604	IM	C 669	C 4	Site C Area Cw IV north, floor	Deep bowl with seal impressions

3 1198 02452 1077



N/1198/02452/1077X

Already available

R.G. Killick (Ed.)

TELL RUBEIDHEH: *An Uruk village in the Jebel Hamrin*

The excavations at Tell Rubeidheh were undertaken as part of the Hamrin Dam rescue project in Eastern Iraq and revealed a mound of the Uruk period. This volume is an excavation report of this site and includes reports on the archaeology, finds, animal and human bones and flints. A summary of the work in Arabic is provided. 0 85668 431 7 (1988)

A. Northedge, A. Bamber, & M. Roaf

EXCAVATIONS AT 'ANA

Qal'at 'Ana is an island in the stream of the Euphrates, the site of the ancient and medieval city of 'Ana, which lies on the Middle Euphrates some 150km below the modern Iraq-Syrian border. It was the centre of the autonomous governorate under the Assyrians, a border fort under the Parthians, Romans and Sasanians, and a caravan town and Bedouin centre under Islam. The excavation in 1981 by the British Archaeological Expedition to Iraq was a rescue project in the basin of the Qadisiyya Dam. 0 85668 425 2 (1987)

T.J. Wilkinson and D.J. Tucker

SETTLEMENT DEVELOPMENT IN THE NORTH JAZIRA, IRAQ, *A Study of the Archaeological Landscape*

Using data from archaeological surveys conducted during the late 80s, this volume charts the ebb and flow of human population in this important part of Upper Mesopotamia. The authors consider the archaeological landscape, water exploitation and the changes in each period studied, giving a picture of the settlement, land use and communications in the area through time. The archaeological landscape, when reviewed in conjunction with the settlement and artefact record, provides here a framework for assessing ancient economy and demography from the early post glacial period until late Islamic times. 0 85668 658 1 (1995)

MUSEUM LIBRARY
UNIVERSITY OF PENNSYLVANIA
PHILADELPHIA, PA 19104-6324
(215) 898-7840

Please return book on or before last date stamped below.

Overdue fines are 10 cents a day for each book.

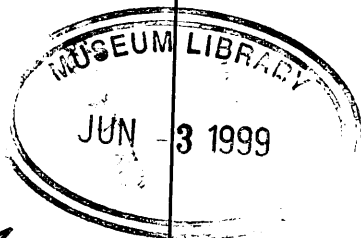

MAR 7 2002
APR 05 2002

APR 28 2003
APR 28 2003

MAY 26 2004
UNIVERSITY OF PENNSYLVANIA
INTERLIBRARY LOAN
FEB 06 2009
INTERLIBRARY LOAN

3 1198 02452 1077
N/1198/02452/1077X



ISBN 0-85668-700-6

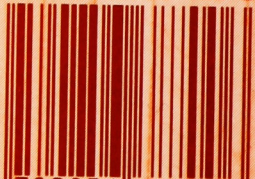

9 780856 687006

ARIS & PHILLIPS Ltd, Teddington House Warminster, Wiltshire, England BA12 8PQ
BRITISH SCHOOL OF ARCHAEOLOGY IN IRAQ