

SAMUEL M. PALEY - RICHARD P. SOBOLEWSKI

THE RECONSTRUCTION OF THE
RELIEF REPRESENTATIONS AND THEIR
POSITIONS IN THE NORTHWEST-PALACE
AT KALĪJU (NIMRŪD) III

SAMUEL M. PALEY – RICHARD P. SOBOLEWSKI

THE RECONSTRUCTION OF THE RELIEF REPRESENTATIONS
AND THEIR POSITIONS IN THE NORTHWEST-PALACE
AT KALĦU (NIMRŪD) III

DEUTSCHES ARCHÄOLOGISCHES INSTITUT
ABTEILUNG BAGHDAD

BAGHDADER FORSCHUNGEN

BAND 14



VERLAG PHILIPP VON ZABERN · MAINZ AM RHEIN

SAMUEL M. PALEY – RICHARD P. SOBOLEWSKI

THE RECONSTRUCTION OF THE
RELIEF REPRESENTATIONS AND THEIR
POSITIONS IN THE NORTHWEST-PALACE
AT KALĦU (NIMRŪD) III

(The Principal Entrances and Courtyards)

1992

VERLAG PHILIPP VON ZABERN · MAINZ AM RHEIN

XX, 56 Seiten mit 1 Textabbildung und 1 Tabelle; 11 Photoabbildungen (Fig. 1–11),
8 Tafeln mit 46 Abbildungen (Plates 1–8) und 5 Pläne (Plans 1–5)

Drawings: H. Lewakowa
Photographs: A. Bodytko & W. Jerke
Plans: R. Sobolewski

Die Deutsche Bibliothek – CIP-Einheitsaufnahme

Paley, Samuel M. – Sobolewski, Richard P.
The Reconstruction of the Relief Representations and their Positions
in the Northwest-Palace at Kalḫu (Nimrūd) III
Mainz am Rhein : von Zabern, 1992
(Baghdader Forschungen; Bd. 14)
ISBN 3-8053-1348-9

NE: GT

© 1992 by Philipp von Zabern, Mainz am Rhein
ISBN 3-8053-1348-9

Alle Rechte, insbesondere das der Übersetzung in fremde Sprachen, vorbehalten. Ohne
ausdrückliche Genehmigung des Verlages ist es auch nicht gestattet, dieses Buch oder Teile
daraus auf photomechanischem Wege (Photokopie, Mikrokopie) zu vervielfältigen.

Printed in Germany by Philipp von Zabern
Printed on fade resistant and archival quality paper (PH 7 neutral)

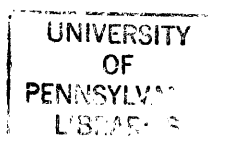

IN MEMORIAM
JANUSZ MEUSZYŃSKI

Contents

Vorwort des Herausgebers	IX	e. Reliefs in Collections Outside of Nimrūd	35
Bibliography and Abbreviations	XI	f. Identifications and Reconstructions	35
List of Abbreviations of Collections with Reliefs from the Northwest-Palace at Nimrūd	XIX	2. Catalogue	36
Introduction	1	IV. Courtyard WT	44
Acknowledgements	2	1. Walls and Entrances	44
I. The Outer Façade of the Throneroom	3	a. Present Condition	44
1. Walls and Entrances	3	b. According to Layard	44
a. Present Condition	3	c. Comparative Analysis of the Sources	45
b. According to Layard	4	d. Reconstruction	45
c. According to Mallowan	8	2. Catalogue	46
d. Comparative Analysis of the Sources	10	SUPPLEMENTS	49
e. Reliefs in Collections Outside of Nimrūd	11	Supplement 1: Catalogue of Relief Fragments at Nimrūd	49
f. Identifications and Reconstructions	12	Supplement 2: Lamassu Sculptures (LL-Lions and LS-Bulls) be- longing to the Official Part of the NW-Palace	52
2. Catalogue	13	Supplement 3: Errata and Additions to the Placement of Reliefs discussed in <i>Reliefdarstellungen I</i> and <i>Relief Representations II</i>	49
II. Room B	26	Supplement 4: Catalogue of Reliefs in Collections Outside Nimrūd	51
1. Entrances	26	List of Figures, Plates and Plans	53
a. Present Condition	26	Index	55
b. According to Layard	26	Figures 1–11	
c. According to Mallowan	28	Plates 1–8	
d. Comparative Analysis of the Sources	28	Plans 1–5	
e. Reliefs in Collections Outside of Nimrūd	29		
f. Identifications and Reconstructions	29		
2. Catalogue	30		
III. Courtyard Y	32		
1. Walls and Entrances	32		
a. Present Condition	32		
b. According to Layard	33		
c. According to Mallowan	34		
d. Comparative Analysis of the Sources	34		

Vorwort des Herausgebers

Mit diesem Band erscheint der dritte und letzte Teil der von Janusz Meuszyński initiierten, nach dessen tragischem Tod von Richard P. Sobolewski unter Mitarbeit von Samuel M. Paley (Buffalo) weiter- und zu Ende geführten Publikationen über die polnischen Untersuchungen in Nimrud¹.

Begonnen wurden sie in den 70er Jahren, als Janusz Meuszyński und Richard P. Sobolewski Stipendiaten der Humboldt-Stiftung waren.

Finanzielle Unterstützung, vor allem bei der Erstellung der druckreifen Zeichnungen, gewährte dankenswerterweise die Fritz Thyssen-Stiftung. Die Abteilung Baghdad des Deutschen Archäologischen Instituts übernahm die Druckkosten und die redaktionelle Betreuung des Bandes. Letztere wurde in allen Phasen durchgeführt von Herrn Stefan R. Hauser, M. A., dem ich dafür herzlich danke.

Sie war nicht einfach; Manuskript, Druckfahnen etc. gingen reihum von Warschau nach Berlin, dann nach Buffalo und wieder nach Warschau; und dies einige Male, bis die letzte Korrektur endlich vorlag.

Da die Autoren auch anderweitige Verpflichtungen hatten, nahm das einige Zeit in Anspruch, woraus sich das späte Erscheinen des Werkes, elf Jahre nach Teil 1 und fünf Jahre nach Teil 2, erklärt.

Ich danke allen Beteiligten für ihren Einsatz.

Auch dieser Band ist dem Andenken von Janusz Meuszyński gewidmet, dem ersten im Irak tätigen polnischen Kollegen, der allen, die ihn kannten, unvergessen bleiben wird.

Berlin, 2. Dezember 1992

Rainer Michael Boehmer

¹ Janusz Meuszyński: Die Rekonstruktion der Reliefdarstellungen und ihrer Anordnung im Nordwestpalast von Kalhu (Nimrud), BaF 2 (1981), S. M. Paley, R. P. Sobolewski: The Reconstruction of the Relief Representations and their Positions in the Northwest-Palace at Kalhu (Nimrud) II, BaF 10 (1987).

Bibliography and Abbreviations

- | | | | |
|---|---|------------------------------------|---|
| AA | Archäologischer Anzeiger, Berlin | BaF | Baghdader Forschungen |
| Abdul Hameed,
manuscript | Hazim Abdul Hameed, Ekal Aššur-
našir-apli II at Kalḫu-Second Re-
port on the Reliefs (unpublished
manuscript in English for Sumer) | BaM | Baghdader Mitteilungen |
| Afanasieva,
Kultura i Iskusstvo | V. Afanasieva, Kultura i Iskusstvo
Pierednej Asii (Leningrad 1971) | Barnett, AssPal | R. D. Barnett, Assyrian Palace Re-
liefs (London 1970) |
| AfO | Archiv für Orientforschung | Barnett-Falkner | R. D. Barnett–M. Falkner, The
Sculptures of Aššur-našir-apli II
(883–859), Tiglath-Pileser III
(745–727), Esarhaddon (681–
669) from the Central and South-
West Palaces at Nimrūd,
(London 1962) |
| Albenda, JANES 10 | P. Albenda, Assyrian Carpets in
Stone, JANES 10, 1978 pp. 1ff. | Bass–Moore | J. Bass–Chr. Moore, Treasures of
the Hood Museum of Art, Dart-
mouth College (New York 1985) |
| Albenda, JNES 31 | P. Albenda, Ashur-nasir-pal II Lion
Hunt Relief BM 124534, JNES 31
(July 1972), pp. 167–178 | Beek, BAK | M. A. Beek, Bildatlas der assyrisch-
babylonischen Kultur (Gütersloh
1961) |
| Albenda,
Palace of Sargon | P. Albenda, The Palace of Sargon
King of Assyria, Édition Ré-
cherches sur les Civilizations (Pa-
ris 1986) | Belke, BMusVars
(1969) | I. Belke, Un fragment de bas-relief
assyrien du Musée National de
Varsovie, BMusVars X I (1969)
pp. 4ff. |
| Ameen Agha &
al-Iraqi, Nimrud | A. Ameen Agha and M. Sa'ïd al-
Iraqi, Nimrud "Calah", Ministry
of Information, Directorate Gen-
eral of Antiquities (Baghdad
1976) | Berg | P. Berg, Man came this way. Ob-
jects from the Phil Berg Collec-
tion, Los Angeles County Mu-
seum of Art, 1971 |
| Amiet, Art of the
Ancient N.E. | P. Amiet, Art of the Ancient Near
East (translated from the French
by J. Shepley and C. Choquet),
H. N. Abrams, Inc., Publishers
(New York 1980) | BiOr | Bibliotheca Orientalis |
| Andrae,
Das Gotteshaus | W. Andrae, Das Gotteshaus und
die Urformen des Bauens im Al-
ten Orient, Hans Schoetz & Co.
(Berlin 1930) | Bleibtreu, Flora | E. Bleibtreu, Die Flora der neuassy-
rischen Reliefs (Wien 1980) |
| Andrae, Das wieder-
erstandene Assur | W. Andrae, Das wiedererstandene
Assur (second expanded edition
edited by B. Hrouda) Verlag
C. H. Beck (München 1977) | Bleibtreu,
WZKM 69 | E. Bleibtreu, Ein neuassyrisches
Relief in Wien, WZKM 69, 1977,
pp. 41ff. |
| Andrae, AfO 15 | W. Andrae, Ausgrabungen und
Forschungen . . . Nimrud, AfO 15
(1945–51), pp. 141–143 | Bleibtreu,
AfO XXV/1988 | E. Bleibtreu, rev. of. P. Albenda,
The Palace of Sargon in AfO
XXV, 1988, pp. 212–214. |
| Asher-Greve-Selz,
GKN | J. M. Asher-Greve–G. J. Selz,
Genien und Krieger aus Nimrūd,
Neuassyrische Reliefs Assurnas-
irpals II. und Tiglat-Pileasars III.,
Archäologische Sammlung der
Universität (Zürich 1980) | BMetrMus | Bulletin. The Metropolitan Mu-
seum of Art, New York |
| | | BMusArt | Bulletin des Musées royaux d'art et
d'histoire, Brüssel |
| | | BMusVars | Bulletin du Musée National de Var-
sovie, Warszawa |
| | | v. Bothmer, Glories
of the Past | D. von Bothmer, editor, Glories of
the Past. Ancient Art from the
Shelby White and Leon Levy
Collection, The Metropolitan
Museum of Art (New York 1990) |

- Botta–Flandin, MNin P. E. Botta–E. N. Flandin, *Monuments de Ninive* (Paris 1849/50)
- Brandes, Salle G M. A. Brandes, *La salle dite "G" du palais d'Assurnasirpal II à Kalakh, lieu de cérémonie rituelle, Compte-rendu de la XVII Rencontre Assyriologique Internationale* (1969) pp. 147 ff.
- Brunn, Beschreibung der Glyptothek H. Brunn, *Beschreibung der Glyptothek König Ludwig's I. zu München* (München 1877)
- Budge, AS E. A. W. Budge, *Assyrian Sculptures in the British Museum. Reign of Ashur-nasir-pal 850–860 B.C.* (London 1914)
- Budge–King E. A. W. Budge–L. W. King, *Annals of the Kings of Assyria I* (London 1902)
- Canby, Iraq 33 J. V. Canby, *Decorated Garments in Ashur-nasir-pal's Sculptures, Iraq 33*, 1971, pp. 31 ff.
- Christie's, Ant. and Prim. Art (1974) Christie's, *Antiquities and Primitive Art* (London, December II, 1974)
- Crawford, Harper, Pittman V. E. Crawford, P. O. Harper, H. Pittman, *Assyrian Reliefs and Ivories in the Metropolitan Museum of Art: Palace Reliefs of Assurnasirpal II and Ivory Carvings from Nimrud, The Metropolitan Museum of Art* (New York 1980)
- de Clercq, Catalogue L. de Clercq, *Collection de Clercq. Catalogue méthodique et raisonné. Tome deuxième: Antiquités assyriennes (cylindres orientaux, cachets, briques, bronzes, bas-relief, etc. . .)* (Paris 1903)
- Croft, Back on the Wall G. Croft, *Back on the Wall (where they belong)*, *Alumni Magazine*. Dartmouth, September 1985, pp. 31 ff.
- M. S. Damerji, Tür- und Torarchitektur Muayad Said Damerji, *Die Entwicklung der Tür- und Torarchitektur in Mesopotamien*, Ph. D. Dissertation, Ludwig-Maximilians-Universität zu München, (München 1973)
- Dyson, Bulletin R. H. Dyson, Jr., *A Gift of Nimrud Sculptures, The Brooklyn Museum Bulletin XVIII*, no. 3, 1937, pp. 1 ff.
- EtTrav Études et Travaux. Travaux du Centre d'Archéologie Méditerranéenne de l'Académie Polonaise des Sciences, Warszawa
- Furtwängler, Beschreibung der Glyptothek A. Furtwängler, *Beschreibung der Glyptothek König Ludwig's I. zu München* (München 1900)
- Gadd C. J. Gadd, *The Stones of Assyria* (London 1936)
- Gadd, Iraq 5 C. J. Gadd, *A Visiting Artist at Nineveh in 1850, Iraq 5*, 1938, pp. 118 ff.
- Gauthier, Palais et Musée M. Gauthier, *Palais et Musée du Louvre* (Paris 1962)
- Golenischtschev, Description W. Golenischtschev, *Impieratorskij Eremitage, Opisanie assyrijskich pamiatnikov* (Petersburg 1897)
- Goossens, BMusArt G. Goossens, *Reliefs d'Ashurnasirpal II, BMusArt 4/28*, 1956, pp. 31 ff.
- Grand Exhibition, Oasis and Steppe Routes The Grand Exhibition of Silk Road Civilizations, *The Oasis and Steppe Routes*, April 24–October 23, 1988, Nara Prefectural Museum of Art, The Association for Silk Road Exposition (Nara 1988)
- Hall, BAS H. R. Hall, *Babylonian and Assyrian Sculpture in the British Museum* (London 1928)
- Hill-Jacobsen, Old Babylonian Public Buildings I. H. D. Hill and T. Jacobsen. *Old Babylonian Public Buildings in the Diyala Region. Part One: Excavations at Ishchali. Part Two: Khafajah Mounds B, C and D by Pinhas Delougaz, OIP 98* (Chicago 1990).
- Hoffman, JHK 18 H. Hoffman, *Jahrbuch der Hamburger Kunstsammlungen 18*, 1973, pp. 216 ff.
- Hrouda, Vorderasien I B. Hrouda, *Vorderasien I, Handbuch der Archäologie 2* (München 1971)
- Hubbard, The National Gallery R. H. Hubbard, *The National Gallery of Canada, Catalogue. Painting and Sculpture, vol. I: Older Schools* (Ottawa 1961)
- Huot, Syria LXIV J. L. Huot, rev. of J. Meuszyński, *Die Rekonstruktion der Reliefdarstellungen und ihrer Anordnung im Nordwestpalast von Kalhu (Nimrud) I, Syria LXIV*, 1987, pp. 154 ff.

- ILN Illustrated London News, London
- Iraq Iraq, published by the British School of Archaeology in Iraq, London
- Iraq 35, EI Excavations in Iraq 1972–73, Iraq 35, 1973, pp. 192 ff. (Edited by N. Postgate)
- Iraq 37, EI Excavations in Iraq 1973–74, Iraq 37, 1975, pp. 59 f. (Edited by N. Postgate)
- Iraq 38, EI Excavations in Iraq 1975, Iraq 38, 1976, pp. 71 f. (Edited by N. Postgate)
- Iraq 39, EI Excavations in Iraq 1976, Iraq 39, 1977, pp. 307 ff. (Edited by N. Postgate)
- Jacobsen, Mesopotamian Temple Plan T. Jacobsen, The Mesopotamian Temple Plan and the Kititum Temple, *Eretz Israel* 20, 1989, pp. 78–91
- Jakob-Rost, Die Inschriften L. Jakob-Rost, *Assyrien. Die Inschriften* (Berlin 1982)
- JANES Journal of the Ancient Near East Society
- JAOS Journal of the American Oriental Society, New Haven
- Jastrow, JAOS 14 M. Jastrow, The Ashurnasirpal Slabs Belonging to the New York Historical Society, *JAOS* 14, 1889, pp. CXXXVIII ff.
- Karkaria, AR R.P. Karkaria, Assyrian Reliefs from Nimroud in the Possession of the B.B.R.A.S., *Journal of the Bombay Branch of the Royal Asiatic Society* 18, 1891, pp. 97 ff.
- Kinnier Wilson, Iraq 24 J. V. Kinnier Wilson, The Kurbail Statue of Shalmaneser III, Iraq 24, 1962, pp. 90 ff.
- Koefoed-Petersen O. Koefoed-Petersen, *Fra Assurnazirpal's Kongeborg i Nimrūd, Meddelelser fra Ny Carlsberg Glyptotek* 13 (København 1956)
- Kuznetsov–Nikulin–Rusakov, Hermitage Y. Kuznetsov–N. Nikulin–Y. Rusakov, *The Hermitage Museum* (Leningrad-Moscow 1965)
- Laessøe, People of Ancient Assyria J. Laessøe, *People of Ancient Assyria. Their Inscriptions and Correspondence* (Translated from the Danish by F.S. Leigh-Browne), Routledge & Kegan Paul (London 1963)
- Laessøe, JCS 7 J. Laessøe, *Reflexions on Modern and Ancient Oriental Water Works*, *JCS* 7, 1953, pp. 5–26 (see id., *JCS* 5, 1951, pp. 21–32)
- Layard, ICC A.H. Layard, *Inscriptions in the Cuneiform Character from Assyrian Monuments* (London 1851)
- Layard, Mon. I–II A. H. Layard, *Monuments of Nineveh I–II* (London 1849–53)
- Layard, Nin. I–II A. H. Layard, *Nineveh and its Remains I–II* (London 1848–49)
- Layard, Nin. Bab. A. H. Layard, *Discoveries in the Ruins of Nineveh and Babylon* (London 1853)
- Le Gac, Estampages Y. Le Gac, *Les inscriptions d'Aššurnāšir-aplu III roi d'Assyrie (885–860 av. J. C.)* (Paris 1907)
- Lerner, Journey's End J. Lerner, *Journey's End: The Assyrian Reliefs at Dartmouth*, *Alumni Magazine*, Dartmouth, Sept. 1985, pp. 30–31
- Lloyd, Foundations Seton Lloyd, *Foundations in the Dust* (London 1980)
- Loud, Khorsabad I G. Loud, et al., *Khorsabad I. Excavations at the Palace and at the City Gate*, University of Chicago Press (Chicago 1936) [OIP XXXVIII]
- Loud, Khorsabad II G. Loud and C. B. Altman, *Khorsabad II. The Citadel and the Town*, University of Chicago Press (Chicago 1938) [OIP XL]
- Madhloom, Chronology T. A. Madhloom, *The Chronology of Neo-Assyrian Art*, The Athlone Press (London 1970)
- Mallowan, Iraq 12 M. E. L. Mallowan, *The Excavations at Nimrud (Kalḫu)*, 1949–1950, Iraq 12, 1950, pp. 147 ff.
- Mallowan, Iraq 13 M. E. L. Mallowan, *The Excavations at Nimrud (Kalḫu)*, 1949–1950, Iraq 13, 1951, pp. 1 ff.
- Mallowan, Iraq 14 M. E. L. Mallowan, *The Excavations at Nimrud (Kalḫu)*, 1951, Iraq 14, 1952, pp. 1 ff.
- Mallowan, Iraq 15 M. E. L. Mallowan, *The Excavations at Nimrud (Kalḫu)*, 1952, Iraq 15, 1953, pp. 1 ff.
- Mallowan, Iraq 16 M. E. L. Mallowan, *The Excavations at Nimrud (Kalḫu)*, 1953, Iraq 16, 1954, pp. 59 ff.
- Mallowan, ILN M. E. L. Mallowan, in: *ILN*, Nr. 5805 (1950); 5806 (1950); 5914 (1952)

- Mallowan, Memoirs M. Mallowan, Mallowan's Memoirs (London 1977)
- Mallowan, Nimrud I–II M. E. L. Mallowan, Nimrud and its Remains I–II (London 1966)
- Margueron, Recherches sur les Palais J. Margueron, Recherches sur les Palais mésopotamiens de l'Âge du Bronze (two volumes), Librairie Orientaliste Paul Geuthner (Paris 1982)
- Markoe, Source II/4 G. Markoe, Five Assyrian Relief Fragments in the Glencairn Museum, Source. Notes on the History of Art II, no. 4 (1983) pp. 1 ff.
- Merrill S. Merrill, Assyrian and Babylonian Monuments in America, Bibliotheca Sacra 32, 1875
- Meuszyński, EtTrav 5 J. Meuszyński, Contribution to the Reconstruction of Interiors of the Northwest Palace in Kalḫu (Nimrūd), EtTrav 5, 1971, pp. 31 ff.
- Meuszyński, ZOW J. Meuszyński, Pałac Aszurnasirapli – Architektura i Propaganda, ZOW 37, 1971, pp. 171 ff.
- Meuszyński, EtTrav 6 J. Meuszyński, The Representations of the Four-Winged Genies on the Bas-Reliefs from Aššurnasirapli II Times, EtTrav 6, 1972, pp. 27 ff.
- Meuszyński, ZA 64 J. Meuszyński, The Throne-Room of Aššurnasirapli II, ZA 64, I, 1975, pp. 51 ff.
- Meuszyński, EtTrav 8 J. Meuszyński, The Aššurnasirapli II Reliefs in the Vorderasiatisches Museum Berlin, EtTrav 8, 1975, pp. 34 ff.
- Meuszyński, Iraq 38 J. Meuszyński, Neo-Assyrian Reliefs from the Central Area of Nimrūd Citadel, Iraq 38, 1976, pp. 37 ff.
- Meuszyński, AA 1976 J. Meuszyński, Die Reliefs von Aššurnasirapli II. Die Sammlungen außerhalb des Irak, AA 1976, pp. 423 ff.
- Meuszyński, EtTrav 9 J. Meuszyński, Some Reliefs from the North-West Palace at Kalḫu, EtTrav 9, 1976, pp. 30 ff.
- Meuszyński, Et Trav 9, Report I J. Meuszyński, Preliminary Report on the First Season of Polish Excavations at Kalḫu (Nimrūd), EtTrav 9, 1976, pp. 265 ff.
- Meuszyński, OM J. Meuszyński, Odkrywanie Mezopotamii, Biblioteka Problemów (Warszawa 1977)
- Meuszyński, EtTrav 10 J. Meuszyński, Original Drawings of Aššurnasirapli II Reliefs, EtTrav 10, 1977, pp. 40 ff.
- Meuszyński, EtTrav 10, Report II J. Meuszyński, Second Preliminary Report on the Polish Excavations at Kalḫu (Nimrūd), EtTrav 10, 1977, pp. 417 ff.
- Meuszyński, EtTrav II J. Meuszyński, La façade de la salle du trône au Palais Nord-Ouest à Nimrūd, EtTrav II, 1978, pp. 6 ff.
- Meuszyński, Reliefdarstellungen I J. Meuszyński, Die Rekonstruktion der Reliefdarstellungen und ihrer Anordnung im Nordwestpalast von Kalḫu (Nimrūd), Baghdader Forschungen 2 (1981)
- Meuszyński–Hazim, Sumer 30 J. Meuszyński–Hazim Abdul Hameed, EKAL Aššurnasirapli, First Report on Reliefs, Sumer 30, 1974, pp. III ff.
- Meyer, AD im VM (1970) G. R. Meyer, Altorientalische Denkmäler im Vorderasiatischen Museum zu Berlin (Leipzig 1970)
- Migeon, C. P. M. MMA, Guide (1966) G. Migeon, Collection Paul Mallon Metropolitan Museum of Art, Guide to the Collections: Ancient Near Eastern Art (New York 1966)
- Mon. I–II see Layard, Mon. I–II
- Moortgat, BJW A. Moortgat, Die Bildgliederung des jungassyrischen Wandreliefs, Jb. d. Preußischen Kunstsammlungen 51, 1930, pp. 141 ff.
- Moortgat, Art A. Moortgat, The Art of Ancient Mesopotamia. The Classical Art of the Ancient Near East, translated by Judith Filson, Phaidon Press (London 1969)
- Müller, Staatliche Sammlung H. W. Müller, Staatliche Sammlung Ägyptischer Kunst (München 1972)
- Nim. I–II see Mallowan, Nimrud I–II
- Nin. I–II see Layard, Nin. I–II
- Nin. Bab. see Layard, Nin. Bab.
- Oppenheim, Ancient Mesopotamia A. L. Oppenheim, Ancient Mesopotamia. Portrait of a Dead Civilization, The University of Chicago Press (Chicago 1969)
- Orthmann, Der Alte Orient W. Orthmann, et al., Der Alte Orient, Propyläen Verlag (Berlin 1975) [Propyläen Kunstgeschichte]
- Or. Dr. III, N. W. Original Drawings Vol. III, North-West Palace. Drawings in the archives of the British Museum
- Paley, KW S. M. Paley, King of the World, Ashurnasirpal II of Assyria

- (883–859 B.C.), *The Brooklyn Museum* (New York 1976)
- Paley, SMS Bulletin (1985) S. M. Paley, Reconstruction of an Assyrian Palace, *Bulletin. The Society for Mesopotamian Studies* 10 (Toronto 1985) pp. II ff.
- Paley, JANES, 1989 S. M. Paley, The Entranceway Inscriptions of the "Second House" in the Northwest Palace of Ashurnasirpal II at Nimrud (Kalḫu), *Journal of the Ancient Near East Society* [Held Memorial Volume], 1989, pp. 135–147
- Paley, Porticus XII/XIII S. M. Paley, A Kneeling Winged Genius in the Memorial Art Gallery, Porticus. *The Journal of the Memorial Art Gallery of the University of Rochester*, XII/XIII, 1989–1990, pp. 2–9
- Paley–Sobolewski (1977) S. M. Paley–R. Sobolewski, The Northwest Palace at Nimrud-Kalḫu: Some Remarks on the Present State of its Preservation; 187. Meeting of the American Oriental Society at Cornell University (April 1977)
- Paley–Sobolewski, Iraq 43 S. M. Paley–R. Sobolewski, A New Reconstruction of Room Z in the NW Palace of Ashur-nasir-pal II at Nimrud (Kalḫu), *Iraq* 43, 1981, pp. 85 ff.
- Paley–Sobolewski, Relief Representations II S. M. Paley and R. P. Sobolewski, The Reconstruction of the Relief-Representations and Their Positions in the Northwest-Palace at Kalḫu (Nimrud) II, *Verlag Philipp von Zabern (Mainz am Rhein 1987)*. [Baghdader Forschungen 10]
- Pallis, Handbook S. A. Pallis, *The Antiquity of Iraq. A Handbook of Assyriology* (København 1956)
- Paterson, Palace A. Paterson, *Assyrian Sculptures, Palace of Sinacherib* (The Hague n. d.)
- Peck, Amer. Conn. W. H. Peck, The Arts of the Ancient Near East in Detroit, *The American Connoisseur*, July, 1973, pp. 200 ff.
- Pillet, PA M. Pillet, *Un Pionnier de l'assyriologie – Victor Place* (Paris 1962)
- Place, NA V. Place, *Ninive et l'Assyrie III* (Paris 1870)
- Porada, Problems of Late Assyrian Reliefs E. Porada, Problems of Late Assyrian Reliefs, in A. Leonard, Jr. and B. B. Williams, ed., *Essays in ancient Civilization presented to Helen J. Kantor*, University of Chicago Press (Chicago 1989), pp. 233–248
- Porada–Hare E. Porada–S. Hare, *The Great King of Assyria, Assyrian Reliefs in the Metropolitan Museum* (New York 1946)
- Postgate-Read, RLA V J. N. Postgate–J. E. Reade, *Kalḫu in: RLA V*, 303–323
- Pottier, Catalogue (1924) E. Pottier, *Musée national du Louvre, Catalogue des Antiquités assyriennes* (Paris 1924)
- Ravn, AfO 16 O. E. Ravn, *Die Reliefs der assyrischen Könige*, AfO 16, 1952/53, pp. 231 ff.
- Reade, AAD J. E. Reade, *Assyrian Architectural Decoration: Techniques and Subject-Matter*, BaM 10, 1979, pp. 17 ff.
- Reade, NCAS J. E. Reade, *Narrative Composition in Assyrian Sculpture*, BaM 10, 1979, pp. 52 ff.
- Reade, Architectural Context J. E. Reade, *The Architectural Context of Assyrian Sculpture*, BaM 11, 1980, pp. 75 ff.
- Reade, AS J. E. Reade, *Assyrian Sculpture* (London 1983)
- Reade, BiOr 41 J. E. Reade, in: *BiOr* 41, 1985, Nr. 3–4, cols. 481 ff. (A Review of: J. Meuszyński, *Reliefdarstellungen I* [1985])
- Reade, Iraq 25 J. E. Reade, A Glazed-Brick Panel from Nimrud, *Iraq* 25 (1963), pp. 38 ff., pl. IX
- Reade, Iraq 27 J. E. Reade, *Twelve Ashurnasirpal Reliefs*, *Iraq* 27, 1965, pp. 119 ff.
- Reade, Iraq 30 J. E. Reade, *The Palace of Tiglath-Pileser III*, *Iraq* 30, 1968, pp. 69 ff.
- Reade, Iraq 34 J. E. Reade, *The Neo-Assyrian Court and Army: Evidence from Sculptures*, *Iraq* 34, 1972, pp. 87 ff.
- Reade, Iraq 47 J. E. Reade, *Texts and Sculptures from the North-West Palace, Nimrud*, *Iraq* 47, 1985, pp. 203 ff.
- Réalités, TL *Réalités*, eds. *Treasures of the Louvre. From the Fourth Millennium B.C. to the Dawn of the Renaissance* (New York 1966)
- RLA *Reallexikon der Assyriologie*
- RLV *Reallexikon der Vorgeschichte*
- Ross, VSJ J. F. Ross, *The Assyrian Reliefs at Virginia Seminary*, The Virginia

- Seminary Journal, Winter 1976, pp. 4ff.
- Russell, BASOR 276/1989 J. M. Russell, rev. of P. Albenda, The Palace of Sargon in BASOR 276 (1989), pp. 88ff.
- Russell, Bulls for the Palace J. M. Russell, Bulls for the Palace and Order in the Empire: The Sculptural Program of Sennacherib's Court VI at Nineveh, The Art Bulletin LXIX/4 (December 1987), pp. 520ff.
- Russell, Inscriptions J. M. Russell, manuscript. Neo Assyrian Palace Inscriptions: The Content and Architectural Context.
- Russell, Sennacherib's Palace J. M. Russell, Sennacherib's Palace Without Rival, Ph. D., Dissertation, University of Pennsylvania (Philadelphia 1985)
- Salman, Sumer 25 I. Salman, Foreword, Sumer 25, 1969
- Salman, Sumer 26 I. Salman, Foreword, Sumer 26, 1971
- Salman, Sumer 29 I. Salman, Foreword, Sumer 29, 1973
- Salman, Sumer 31 I. Salman, Foreword, Sumer 31, 1975 (Arabic Section)
- Schäfer-Andrae H. Schäfer-W. Andrae, Die Kunst des alten Orients (Berlin 1925) pp. 508f.
- Seton-Williams, Babylonien M. V. Seton-Williams, Babylonien (Hamburg 1981)
- Shukri, Sumer 12 A. Shukri, Report on the Reconstruction Work in Rooms D and E of the NW-Palace (in Arabic), Sumer 12, 1956, pp. 134ff.
- Sobolewski, AfO 25 Kalhu R. Sobolewski, Kalhu (Nimrüd), Die Ausgrabungen in Kalhu (Nimrüd) 1974-76, AfO 25, 1974/1977, pp. 230ff.
- Sobolewski, AfO-Beih. 19 R. Sobolewski, The Shalmanaser III Building in the Central Area of the Nimrüd Citadel, AfO-Beih. 19 (1982) pp. 330ff.
- Sobolewski, EtTrav XI R. Sobolewski, Preliminary Report on the Third Season of Polish Excavations at Kalhu (Nimrüd), EtTrav XI, 1978, pp. 253ff.
- Sobolewski, Palast und Hütte R. Sobolewski, Beitrag zur theoretischen Rekonstruktion der Architektur des Nordwest-Palastes in Nimrüd (Kalhu) Palast und Hütte, Beiträge zum Bauen und Wohnen im Altertum (Mainz 1982) pp. 237ff.
- Sobolewski, BiOr 1-2/1991 R. Sobolewski, rev. of P. Albenda, The Palace of Sargon in BiOr 1-2/1991
- Al-Soof, Sumer 19 B. A. Al-Soof, Further Investigations in Aššur-Našir-Pal's Palace, Sumer 19, 1963, pp. 66ff.
- Sotheby's, Catalogue 1968 Sotheby and Company, Catalogue of Egyptian, Western Asiatic, Greek, Etruscan and Roman Antiquities, New York, November 26, 1968
- Sotheby's, Catalogue 1969 Sotheby and Company, Catalogue of Egyptian, Western Asiatic, Greek, Etruscan and Roman Antiquities, also Islamic Pottery and Metal Work, New York, December I, 1969
- Sotheby's, Catalogue 1988 Sotheby's, Antiquities, London, Monday 12th, December 1988
- Stearns, AfO-Beih. 15 J. B. Stearns, Reliefs from the Palace of Assurnasirpal II, AfO-Beih. 15 (Graz 1961)
- Stephens, Bulletin 1936 F. J. Stephens, Assyrian Bas-reliefs Rejoined, Bulletin of The Associates in Fine Arts at Yale University VII (1936) pp. 26ff.
- Stephens, VHT F. J. Stephens, Votive and Historical Texts from Babylonia and Assyria, Yale Oriental Series, Babylonian Texts IX (New Haven 1937)
- Stettler M. Stettler, Die kulturelle Monatschrift 28, 1968
- Strommenger, 5000 Years E. Strommenger-M. Hirmer, 5000 Years of the Art of Mesopotamia (translated by Christina Haglund), (New York 1974)
- Sumer Sumer, A Journal of Archaeology and History in Iraq, Baghdad
- Turner, Iraq 32 G. Turner, The State Apartments of Late Assyrian Palaces, Iraq 32, 1970, pp. 177ff.
- Van Soldt, Cuneiform Texts W. H. Van Soldt, The Cuneiform Texts in the Rijksmuseum van Oudheden, Leiden (I). Oudheidkundige Mededelingen, Rijksmuseum van Oudheden 63 (1982) pp. 43ff.
- Verzeichnis Verzeichnis der Vorderasiatischen Altertümer und Gipsabdrücke (Berlin 1889)
- Weidner, AfO 12 E. F. Weidner, Review of C. J. Gadd, The Stones of Assyria, AfO 12, 1937-39, pp. 374ff.

- | | | | |
|--------------------------------|--|---------------------------|---|
| Weidner, AfO 15 | E. F. Weidner, <i>Ausgrabungen und Forschungen</i> , AfO 15, 1945–51, pp. 143 ff. | | tan Museum of Art (New York 1983) |
| Weidner, AfO 15.16.17.19 | E. F. Weidner, <i>Die Reliefs der assyrischen Könige</i> , AfO 15, 1945–51, pp. 138 ff.; AfO 16, 1952/53, pp. 352 f.; AfO 17, 1954–56, pp. 193 ff., 415 ff.; AfO 19, 1959/60, pp. 190 ff. | Winter,
Royal Rhetoric | I. J. Winter, <i>Royal Rhetoric and the Development of Historical Narrative in Neo-Assyrian Reliefs</i> , <i>Studies in Visual Communication</i> 7, no. 2, Spring 1981, pp. 2 ff. |
| Weidner, AfO-Beih. 4 | E. F. Weidner, <i>Die Reliefs der assyrischen Könige</i> AfO-Beih. 4 (Berlin 1939) | WZKM | Wiener Zeitschrift für die Kunde des Morgenlandes |
| Winter, The Program-Throneroom | I. J. Winter, <i>The Program of the Throneroom of Assurnasirpal II</i> in P. O. Harper and H. Pittman, <i>Essays on Near Eastern Art and Archaeology in Honor of Charles Kyrle Wilkinson</i> , <i>The Metropoli-</i> | ZA | <i>Zeitschrift für Assyriologie und Vorderasiatische Archäologie</i> |
| | | ZOW | <i>Z Otcłłani Wieków (Kwartalnik Polskiego Towarzystwa Archeologicznego)</i> , Warszawa |
- For the terminology and other abbreviations see J. Meuszyński, *Reliefdarstellungen I*, p. XV

List of Abbreviations of Collections with Reliefs from the Northwest-Palace at Nimrūd

Albany	Albany, New York, Institute of History and Art (now in Norfolk)	Copenhagen, Ny Carls.	Copenhagen, Ny Carlsberg Glyptotek
Alexandria	Alexandria, Virginia, Virginia Theological Seminary	Detroit	Detroit, Michigan, The Detroit Institute of Arts
Amherst	Amherst, Massachusetts, Amherst College	Dresden	Dresden, Staatliche Skulpturen-Sammlung
Baghdad, IM	Baghdad, Iraq Museum	Dublin	Dublin, Weingreen Museum of Biblical Antiquities, Trinity College
Baltimore	Baltimore, Maryland, Walters Art Gallery	Fort Worth	Fort Worth, Texas, Kimbell Art Museum
Berlin, VA	Berlin, Vorderasiatisches Museum	Genua	Genua, Museo Civico di Archeologia
Bern	Bern, Abegg-Stiftung	Glasgow	Glasgow, The Burrell Collection
Birmingham	Birmingham, City Museum and Art Gallery	Hamburg	Hamburg, Museum für Kunst und Gewerbe
BM	British Museum, London	Hanover	Hanover, New Hampshire, Dartmouth College, Hood Museum
BM, N. Gall.	British Museum, Nimrud Gallery, London	Hartford	Hartford, Connecticut, Wadsworth Atheneum
Bombay	Bombay, Prince of Wales Museum	Houston	Houston, Texas, The Museum of Fine Arts (ex-Sandon Hall 2)
Boston	Boston, Massachusetts, Museum of Fine Arts	Istanbul	Istanbul, Asariatika Müzeleri
Bristol	Bristol, Museum and Art Gallery	Kalamazoo	Kalamazoo, Michigan, Kalamazoo Public Museum
Brooklyn	Brooklyn, New York, Brooklyn Museum	Kansas	Kansas City, Missouri, William Rockhill Nelson Gallery of Art
Brunswick	Brunswick, Maine, Bowdoin College	Lausanne	Lausanne, Collection Samuel Josefowitz (ex-Sotheby, 1968)
Bruxelles	Bruxelles, Musées Royaux d'Art et d'Histoire	Leiden	Leiden, Rijksmuseum van Oudheden
Bryn Athyn	Bryn Athyn, Pennsylvania, The Museum, The Academy of the New Church	Leningrad	Leningrad, Gosudarstwiennyj Eremitage
Burlington	Burlington, Vermont, Fleming Museum, University of Vermont	Lissabon	Lissabon, Fundação Calouste Gulbenkian Museum
Cambridge	Cambridge, Fitzwilliam Museum	London,	London, England, British Rail Society, Pension Fund Collection (ex-Sandon Hall 1)
Cambridge, Mass.	Cambridge, Massachusetts, Fogg Art Museum	British Rail	
Chicago, AI	Chicago, Illinois, The Art Institute of Chicago	Los Angeles	Los Angeles, County Museum of
Chicago, OI	Chicago, Illinois, The Oriental Institute Museum of the University of Chicago		
Cincinnati	Cincinnati, Ohio, Cincinnati Art Museum		
Cleveland	Cleveland, Ohio, Museum of Art		
Copenhagen	Copenhagen, Nationalmuseet		

	Art, Los Angeles, California (ex-Newcastle)	Rochester	Rochester, New York, Memorial Art Gallery
		Rome	Rome, Museo Barracco
Manchester	Manchester, The Manchester Museum	Sandon Hall	Sandon Hall, Staffordshire (England) (1—now in London, British Rail; 2—now in Houston)
Middlebury	Middlebury, Vermont, Middlebury College	Santa Barbara	Santa Barbara (USA), Private Collection Logan T. McMenemy (now in London, private collection)*
Minneapolis	Minneapolis, Minnesota, Institute of the Arts	St. Louis	Saint Louis, Missouri, City Art Museum
Moşul	Moşul Museum (Iraq)	Shelby Coll.	Shelby White-Leon Levy Collection, New York
Munich	Munich, Staatliche Sammlung Ägyptischer Kunst	Stockholm	Stockholm, Nationalmuseum
Newcastle	Newcastle-upon-Tyne, Literary and Philosophical Society, now in Los Angeles (see J. E. Reade, Iraq 27, pp. 131f.)	Tokyo	Tokyo, Idemitsu Museum of Arts (ex-Christie's 1974) at The Middle Eastern Culture Center
New Haven	New Haven, Connecticut, Yale University	Toronto	Toronto, Royal Ontario Museum of Archaeology
New York	New York, New York, Metropolitan Museum of Art	Vatican	Città del Vaticano, Museo Vaticano
New York Hist. Soc.	New York, New York, Historical Society (now in Brooklyn)	Warszawa	Warszawa, Muzeum Narodowe
Norfolk	Norfolk, Virginia, Norfolk Museum of Arts and Sciences (ex-Albany)	Wien	Wien, Mechitharisten Congregation
Ottawa	Ottawa, National Gallery of Canada	Williamstown	Williamstown, Massachusetts, Williams College
Oxford, Ash.	Oxford, Ashmolean Museum	Worcester	Worcester, Massachusetts, Worcester Art Museum
Oxford, Christ	Oxford, Christ Church College	Zürich	Zürich, Archäologische Sammlung der Universität
Oxford, Mag.	Oxford, Magdalen College		
Paris, AO	Paris, Musée du Louvre, Antiquités Orientales		
Philadelphia	Philadelphia, Pennsylvania, University Museum		
Princeton	Princeton (USA), Princeton University		
Richmond	Richmond, Virginia, Virginia Museum of Fine Arts		

* see: Sotheby, Catalogue 1986

Introduction

This is the third and last of a three-volume work which had as its purpose the updating of research on the reconstruction of the decorated walls of Ashurnasirpal II's palace at Kalḫu (Nimrūd). This volume is dedicated to a discussion of the decoration of the principal entrances in and to the palace, and reviews, where applicable, associated relief-work and inscriptions. Readers are directed to the earlier volumes to familiarize themselves with the notation system used in this one* and for changes made in the exposition of the monuments owing to further research.

As in volume II, supplementary remarks are added at the end, revising mistakes made in the earlier publications and adding new data. One of the gratifying results of the work of Meuszyński and followed by our own, is that colleagues and friends have commented on the work and showed us where we have erred, and occasionally even provided us with references to fragments of relief that had escaped us and previous researchers. As we still have several items of unfinished business which could not be included here because of the pressures of the publication schedule, we hope to continue our work. We also hope that more fragments will be "unearthed" for our future publications, and that those fragments can be placed in our schema or be used to create new reconstructions.

Much of the data for this volume was collected during the years when we were writing volume II. And, although some of the text of this publication was completed from 1988 to 1990, it was not possible to compile the manuscript, check readings, and edit the manuscript until the 1991–92 academic year. Professional and personal commitments could not be put aside. Always the mails conspire against us. This time because of lack of funding for travel, we could not meet. A chapter planned (and promised) on the principles of Assyrian architecture has been put off for the future along with a thorough review of our reconstruction of room "I" which, because of the rediscovery of a relief from this room of which we had not been aware, must now be revised.

The concentrated work periods were made possible through the support of several institutions. The numerous thank-you's to be proffered must begin with the German

Archaeological Institute, which covered all the printing and redaction costs. A generous grant by the Fritz von Thyssen Stiftung helped the authors to complete the drawings. The photograph materials were made accessible to us thanks to the generosity of the Polish Center of Archaeology in Cairo and to its kind permission to publish them by the Iraqi State Organization of Antiquities. The State University of New York at Buffalo granted Paley a sabbatical for the purpose of finishing his part of the research and writing.

We thank our friends and colleagues for their patience: we promised that this project would be finished before this. We especially thank Professor Dr. R. M. Boehmer for his indulgence as one deadline after the other passed; to Professor A. K. Grayson for providing a copy of his unpublished manuscript of the inscriptions on the *lamassu*, which saved us time by allowing us to rely on his readings of examples we could not examine ourselves; to J. M. Russell for collaborating on the reading of the pavement slabs in his photo archive; to E. R. Barbanes for sharing detail shots of Assyrian architecture from her photograph collection.

Again, individual colleagues who helped answer questions are mentioned in the footnotes or text in the appropriate places and in the list that follows. Mrs. Halina Lewakowa rendered the drawings for this publication. Mr. W. Jerke and A. Bodytko rendered the photographs in Nimrūd. Typing was done on a Zenith Laptop in Word Perfect 4.2, initialized and then printed in Word Perfect 5.1 format by Bonnie Weiss in the Department of Classics at SUNY at Buffalo and at The Bit Bucket, West Newton, Mass.

This volume is dedicated to the memory of Dr. Janusz Meuszyński, colleague and friend.

* See, Meuszyński, *Reliefdarstellungen I* and Paley-Sobolewski, *Relief Representations II*.

ACKNOWLEDGEMENTS

Dr. Miassar Said Abdelraziq, former director of the Nimrūd Excavations, State Organization of Antiquities, Baghdad

Dr. Hazim Abdul-Hameed, director, The Moṣūl Museum, Moṣūl

Eleanor R. Barbanes, School of Architecture and Environmental Design, State University of New York at Buffalo

The British School of Archaeology in Iraq

Prof. Dr. Rainer M. Boehmer, director, German Archaeological Institute, Baghdad

Dr. Muayad Said Damerji, director, The State Organization of Antiquities, Baghdad

Dr. Muayad Said Damerji, director, The State Organization of Antiquities, Baghdad

Dr. Prudence O. Harper, curator, Department of Ancient Near Eastern Art, The Metropolitan Museum of Art

Prof. Dr. Barthel Hrouda, Institute for Ancient Near Eastern Archaeology, The University of Munich

The Alexander von Humboldt Stiftung

Prof. Dr. A. Kirk Grayson, Department of Near Eastern Studies, University of Toronto, Ontario, Canada and director of the Royal Inscriptions of Mesopotamia Project

The Iraqi State Organization of Antiquities

Mr. Richard Keresey, Sotheby's, New York

Dr. Glen Markoe, curator of Classical and Near Eastern Art, Cincinnati Art Museum, Ohio

Paula Metzner, registrar, Kalamazoo Public Museum, Michigan

Mr. Samuel Merrin and The Merrin Gallery, New York

The Late Professor Dr. Kazimierz Michałowski, director, The Polish Academy of Science, Warsaw

The Polish Center of Archaeology, University of Warsaw

Prof. Dr. Edith Porada, honorary curator of seals and tablets, The Pierpont Morgan Library, New York

Prof. Dr. Holly Pittman, Department of Art History, The University of Pennsylvania, Philadelphia

Dr. J. N. Postgate

Dr. Julian E. Reade, Department of Western Asiatic Antiquities, The British Museum, London

Prof. Dr. John M. Russell, assistant professor, Department of Art history and Archaeology, Columbia University, New York

Sotheby and Company, London and New York

The Fritz von Thyssen Stiftung, Köln

Nancy Thomas, associate curator, Ancient and Islamic Art, Los Angeles County Museum of Art, California

Buffalo and Warsaw, May 15, 1991

I. The Outer Façade of the Throneroom (incorporating the decorated elements of courtyards E, D and ED)

This façade was discussed previously by Mallowan and Meuszyński¹. Portions of the content of those discussions will be repeated here to help explain the subject matter in a broader context and to give reasons for the present recon-

struction. Layard discovered that this façade was preserved only on its eastern and western ends. He designated those areas as chambers E and D, respectively². The center of the façade was nearly obliterated.

1. Walls and Entrances

A. PRESENT CONDITION

Reconstruction work by the Iraqi State Organization of Antiquities has restored the areas around the east and west entrances of this façade, that is courtyards E and entrance B(E)-c and courtyard D and entrance B(D)-d. This restoration includes 5 complete or nearly complete wall reliefs, 6 partly preserved wall reliefs, 2 complete socles of wall reliefs, 4 complete or nearly complete lion colossi, 1 complete bull colossus and 1 significantly restored bull colossus³. (See Plans 1.4, Plates 1.2.3.4).

There is room for a single slab east of E-1, but we have no conclusive information about the original disposition of the walls of this space⁴.

All restorations by the Antiquities Organization were skillfully accomplished from the many dozens of fragments; plaster casts have been provided to replace missing pieces of relief that happened to have survived in collections outside of Iraq⁵. There are also inscribed floor pavement slabs in the entranceways.

Completely or nearly completely preserved wall reliefs:

D-1 (4 winged genius, A-II-a-ii-type, oversize, facing left, ←), D-3 (two officers with hands folded, facing left, ←), D-4 (one officer with hands folded, one herald; both facing left, ←), D-6 (one vassal with hands raised in a sign of submission, one bearing tribute; both facing left, ←), D-8 (three vassals with hands raised as a sign of submission, all facing left, ←).

Partly preserved reliefs:

E-1 (lower part of the garments and feet of two vassals, facing right, →); E-2 (lower part of the garment and feet of a vassal, facing right, →); E-3 (lower part of the garments and feet of two vassals, facing left, ←); E-4 (lower part of the garments and feet of two vassals, facing left, ←); E-5

(lower half of a 4-winged genius, A-II-a-i-35, oversize, facing right, →); D-5 (lower part of the garments and feet of two vassals, facing left, ←), and two additional fragments: the left vassals head and raised hands with the tribute carried by his fellow vassal following him, and the head and shoulders of this second tribute bearer); B(D)-d-3 (lower part of a slab for a Standard Inscription, only); B(D)-d-4 (lower part of a slab for a Standard Inscription, only); B(E)-c-3 (lower part of a slab for a Standard Inscription, only).

Completely preserved lion colossi:

B(E)-c-1 and B(E)-c-2 (each with human head and torso, and folded hands, facing left (←) and right (→), respectively); B(D)-d-1 and B(D)-d-2 (each with human head and torso, and carrying flowers and an offering, facing left (←) and right (→), respectively).

¹ Mallowan, *Iraq* 15, pp. 28–29; *Nim*, I, pp. 99, 103–6. Meuszyński, *EtTrav* XI; Meuszyński, *Reliefdarstellungen* I, pp. 31 ff., plates 5–6.2, plans 1–3.5.6.

² See below, pp. 6f.

³ These colossal doorway figures have been called *lamassu* and *alad-lammü*. Mallowan, *Nim*, I, p. 103 and Sobolewski, *ZA* 71/II, p. 273. n. 11 (after von Soden).

⁴ The British excavation discovered that it was rebuilt in antiquity with a new floor (the floor bricks were the size attributed to Shalmaneser III) and mudbrick buttresses. Mallowan, *Nim*, I, pp. 59 ff. See below, p. 25.

⁵ Shukri, *Sumer* 12, pp. 134 ff. Photographs of the fragments used in the reconstructions, the reconstructions in progress and the results, have been published by Meuszyński, Mallowan, Shukri, Ainachi and Ameen Agha and al-Iraqi. See the references collected below in the bibliographies of the items in the Catalogue. It is interesting to observe the depth at which these discoveries were found which answers the questions that modern students, unfamiliar with these sites, ask concerning why early excavators tunneled.

Completely preserved bull colossus:

ED-1 (oversize, facing left, ←).

Partly preserved bull colossus:

ED-10 (oversize, facing right, →).

Completely preserved socles:

D-2, E-7, (B)E-c-4.

No preserved socles:

east of E-1 (?), ED-2, ED-3, ED-4, ED-e-1, ED-e-2, ED-5, ED-6, ED-7, ED-8, ED-9, D-9 ff.

Preserved inscribed pavement slabs:

two rectangular slabs in entrance B(D)-d, one rectangular slab in entrance B(E)-c. The inscriptions on these slabs are worn away. Also, two seats and a threshold slab for entrance ED, inscribed (Plan 4).

Corners are composed of two slabs, the end of one abutting the face of the other at an angle. Blank margins are visible on the left side of the preserved, *in situ* portion of E-5 as well as on the right sides of D-1 and D-8. We assume that the same is the case in the reconstructed doorway ED as has been suggested on the plan. See below the discussion of the reconstruction of the center of the façade.

Inscribed stone slabs paved the entrances. Lines of text were cut left to right across the pavements. Wear from continuous pedestrian traffic is noticeable on each example, the inscribed signs being mostly effaced. Comparison of the present *in situ* evidence with Layard's publications of some of these pavement inscriptions in *ICC*, resulted in the present record which documents considerable deterioration since his time. Individual signs at the beginning of each line of inscription are best preserved close to the eastern colossi of entrances B(E)-c and B(D)-d, but hardly anything else survived. Some signs seem to have been inlaid with a metal composition (see below). Ancient wear and modern erosion have conspired to destroy these inscriptions.

B. ACCORDING TO LAYARD

The plans of "chambers" E and D can be found in *Nin. I*, plan 3, *Mon. I*, plate 100, and *Nin. Bab.* plan 3. Passages describing the way this façade and its entrances were discovered, as well as Layard's hypotheses concerning how they might have looked in their original state – in the end, he generalized from the evidence of other Assyrian monuments that he found, as we have – follow. These passages are particularly rich in details.

"Several doorways formed by gigantic winged lions or bulls, or by figures of guardian deities, led into other apartments, which again opened into more distant halls." (*Nin. II*, p. 208)

"The north-west palace having been so fully described in

my former work, I need only add that I have now been able to ascertain the position of its principal façade and entrance. It was to the north, facing the tower, and nearly resembled the grand approaches to Kouyunjik and Khorsabad. The two gateways formed by the sphinxes with human form to waist, appear to have flanked a grand centre portal to which they were united on both sides, as in Sennacherib's palace, by colossal figures of human-headed bulls and lions and winged priests. The remains of no other great entrances to the palace have yet been discovered, but I have little doubt from several indications on the ruins, that there was a similar façade on the river side, and that a terrace, ascended by broad flights of steps overlooked the Tigris. (I understand that Mr. Hormuzd Rassam has lately discovered the remains of some very fine bas-reliefs near this edge of the mound.)" (*Nin. Bab.*, p. 654)

Layard described the palace of Sennacherib at Nineveh in similar terms earlier in the same volume, including a reference to riverside steps, during which he made the following remarks about entrances, which are relevant to our discussion here:

"The western façade, like the eastern, was formed by five pairs of human-headed bulls, and numerous colossal figures (see plan I), forming three distinct gateways." (*Nin. Bab.*, p. 645).

Bulls notwithstanding, the statement is relevant in the context of a discussion of how Layard thought the throneroom façade in the Northwest Palace should have looked in its original state.

Size of the sculptures

"The slabs used as panelling to the walls of unbaked brick rarely exceeded twelve feet in height, and in the earliest palace of Nimroud were generally little more than nine; whilst the human-headed lions and bulls, forming doorways, vary from ten to sixteen"⁶. (referring to Nineveh, but relevant here: *Nin. II*, p. 203.)

Inscribed pavements in the doorways

"The pavement of the chambers was formed either of alabaster slabs, covered with inscriptions recording the name and the genealogy of the king, and probably the chief events of his reign, or of kilnburnt bricks, each also bearing a short inscription. The alabaster slabs were placed upon a thin coating of bitumen spread over the bottom of the chamber, even under the upright slabs forming its sides. The bricks were laid in two tiers, one above the other; a thin layer of sand being placed between them, as well as under the bottom tier. These strata of bitumen and sand may

⁶ The heights of individual parts of the façade were described elsewhere in his text; see below, p. 7.

have been intended to exclude damp; although the buildings, from their positions, could scarcely have been exposed to it. Between the lions and bulls forming the entrances, was generally placed one large slab, bearing an inscription." (*Nin.* I, p. 206)

Superstructure and Arches

"Even these colossal figures did not complete the height of the room; the wall being carried some feet above them. This upper wall was built either of baked bricks, richly colored, or of sun-dried bricks covered by a thin coat of plaster, on which were painted various ornaments. It could generally be distinguished in the ruins. The plaster which had fallen, was frequently preserved in the rubbish, and when first found the colors upon it had lost little of their original freshness and brilliancy . . .

The roof was probably formed by beams, supported entirely by the walls; smaller beams, planks or branches or trees, were laid across them, and the whole was plastered on the outside with mud. Such are the roofs in modern Arab cities of Assyria⁷." (*Nin.* II, pp. 203–5)

"It has been seen that the principle of the arch was known to the Assyrians, a small vaulted chamber of baked bricks having been found at Nimroud; but there are no traces of an arch or vault used on a large scale⁸." (*Nin.* II, p. 205)

Lighting

"If daylight were admitted into the Assyrian palaces, it could only have entered from the roof. There are no communications between the inner rooms except by the doorways, consequently they could only receive light from above. Even in the chambers next to the outer walls, there are no traces of windows⁹."

It might be conjectured therefore, that there were square openings or skylights in the ceilings, which may have been closed during winter rains by canvas or other such material. The drains, leading from almost every chamber, would seem to show that water might occasionally have entered from above and that apertures were required to carry it off . . . No other [*mode of lighting*] can have existed in the palaces of Assyria, unless, indeed, torches and lamps were used; a supposition scarcely in accordance with the elaborate nature of the sculptures, and the brilliancy of the colored ornaments; which, without the light of day, would have lost half their effect." (*Nin.* II, pp. 205–6)

Upper stories?

"Although there were houses in Assyria of two and three stories in height, as at Babylon (*Herod.*, lib. I. c. 180) and as

represented in the sculptures of Koujunjik (At Nimroud, although there were towers represented in the bas-reliefs, with windows evidently belonging to the upper stories, yet there were no houses of two stories.), yet it does not appear probable that the great buildings just described had more than a ground floor. If there had been upper rooms, traces of them would still be found, as is shown by the discovery of the chambers on the western face of the mound (see p. 19 of this volume)¹⁰. Had they fallen in, some remains of them would have been left in the lower rooms.

The houses and towers represented in some of the later sculptures, have windows and doors ornamented with cornices. We have no means of ascertaining the forms of the chambers, nor of learning any particulars concerning their internal economy and arrangement." (*Nin.* I, pp. 213–214)

Exterior of the palace

"All the edifices hitherto discovered in Assyria have precisely the same character, so that we have most probably the palace and temple combined; for in them the deeds of the king, and of the nation, are united with religious symbols, and with the statues of the gods.

Of the exterior architecture of these edifices, no traces remain. I examined as carefully as I was able the sides of the great mound at Nimroud, and of other ruins in Assyria; but there were no fragments of sculptured blocks, cornices or other architectural ornaments, to afford any clue to the nature of the façade. It is probable that as the building was raised on a lofty platform, and was conspicuous from all parts of the surrounding country, its exterior walls were either cased with sculptured slabs or painted. This mode of decorating public buildings appears to have prevailed in Assyria. At Khorsabad, a series of alabaster slabs, on

⁷ Layard continues with arguments against barrel vaulting, suggests and then dismisses the "king-post" method of roofing, and remains with the arguments for flat roofs and/or "in the larger halls a projecting ledge, sufficiently wide to afford shelter and shade, (which) may have been carried around the sides, leaving the centre exposed to the air". Beams for flat roofs come from either palm or poplar (*Nin.* II, p. 205). Cf. Mallovan, *Nim.* I, pp. 104 ff., for his version of this discussion.

⁸ Evidence for arches were discovered by British and Iraqi excavations on a scale large enough for the monumental doorways described here. See below our discussion of the arch and the evidence from courtyard Y and entrance *f*. Layard did not recognize the significance of some of the painted brick.

⁹ A footnote discards the notion of torch lighting or bitumen and naphtha fires because no traces of smoke or fire were found on the sculptures of the Northwest Palace. See also, note 10, below.

¹⁰ Later, when discussing the reconstruction of the Southwest Palace at Koujunjik, Layard doubles back on this point, acknowledging that further evidence showed that Assyrian palaces could have upper stories and that pillars might have been used, which, in addition, would have allowed more light to enter the rooms. His remarks do not include inner rooms for which there was no evidence at all. He did allow for windows in upper stories. *Nin. Bab.*, pp. 647–651.

which were represented gigantic figures bearing tribute, appeared to M. Botta to be an outer wall, as there were no remains of building beyond it. It is possible that the sculptures on the edge of the ravine in the north-west palace of Nimroud, also apparently captives bearing tribute, may have formed part of the north façade of the building, opening upon a flight of steps, or upon a road leading from the river to the great hall. (D and E, plan 3, and see Vol. I, p. 117)." (*Nin.* I, pp. 211–212)

Entrance c, Chamber B (B[E]-c)

"The first slab forming the northern wall after the cornerstone, was occupied by a human figure, with four wings; his right hand was raised, and in his left was a mace. Beyond were two lions (Entrance *c*, Chamber B, plan 3) to correspond with those forming the entrance *d*, from which they differed somewhat in form, the hands being crossed in front, and no animal being carried on the arm. They led to an outer wall or vestibule similar to that marked E, in the 3rd plan. The bas-reliefs represented figures bearing ornaments; there was another gigantic figure like that already described, which was also broken into two pieces.

As the edge of a deep ravine had now been reached by the trenches, the workman were directed to return to the yellow bulls..." (*Nin.* I, p. 124).

Appendix:

"N. 26. Colossal human figure, with four wings; the right hand raised, and in the left a mace: facing entrance *c*¹¹. Entrance *c*, 1 and 2, Winged human headed lions, with human arms, and with their hands crossed in front: facing chamber E. 3 and 4, slabs with standard inscription." (*Nin.* I, p. 310)

Chamber E

Appendix:

"Nos. 1 and 2. Figures resembling Nos. 5–8, chamber D, bringing earrings, bracelets, and other ornaments on trays.
3 and 4. Similar to 1 and 2.
5. Gigantic winged figure resembling No. 1, chamber D." (*Nin.* I, p. 312)

"Chamber" ED

"On the edge of the ravine, to the north of chamber B, (Plan 3) I discovered two enormous winged bulls, about seventeen feet in height, which had fallen from their places. They did not form an entrance, but each one stood alone, adjoining the great slabs with the colossal winged figures in

chambers D and E. I was unable to raise them, and the sculptured face of the slab was downward. They had evidently been long exposed to the atmosphere, and the heads had been greatly injured." (*Nin.* I, p. 88)

"Figures of captives bearing objects of tribute... may be seen on walls near this ravine; and two enormous bulls, and two winged figures above fourteen feet high, are lying on its very edge." (*Nin.* I, p. 92)

Entrance d, Chamber B (B[D]-c)

"I ascertained by the end of March the existence of a second pair of winged, human-headed lions, differing from those previously discovered in form, the human shape being continued to the waist and furnished with arms. In one hand each figure carried a goat or stag, and in the other, which hung down by the side, a branch with three flowers. They formed a northern entrance into the chamber of which the lions previously described were a portal. I completely uncovered the latter, and found them to be entire. They were about twelve feet in height, and the same number in length. The body and limbs were admirably portrayed; the muscles and bones, although strongly developed to display the strength of the animal, showed at the same time a correct knowledge of the anatomy and form. Expanded wings sprung from the shoulder and spread over the back; a knotted girdle, ending in tassels, encircled the loins. These sculptures, forming an entrance, were partly in full and partly in relief. The head and fore-part, facing the chamber, were in full; but only one side of the rest of the slab was sculptured, the back being placed against the wall of sun-dried bricks. That the spectator might have both a perfect front and side view of the figures, they were furnished with five legs; two were carved on the end of the slab to face the chamber, and three on the side. The relief of the body and three limbs were high and bold, and the slab was covered in all parts not occupied by the image, with inscriptions in the cuneiform character. These magnificent specimens of Assyrian art were in perfect preservation; the most minute lines in the detail of the wings and in the ornaments had been retained in their original freshness. Not a character was wanting in the inscriptions." (*Nin.* I, p. 75)

"Between them was a large pavement slab covered with cuneiform characters." (*Nin.* I, p. 110)

Appendix:

"No. 29. Colossal winged human figure, carrying stag on one arm, and in the left hand a flower with five blossoms; facing entrance *d*¹².

¹¹ This is B-26.

¹² This is B-29.

Entrance *d*, 1 and 2. Human-headed lions with arms, similar to those at entrance *e*, but carrying a stag or ram in one arm, and holding a flower with three blossoms in the right hand: facing chamber D. 3 and 4, unsculptured slabs with standard inscription.

No. 30. Two colossal winged human figures, back to back. That to the east similar to No. 29, and facing entrance *d*; the other bearing the square vessel and fir-cone, and facing no. 31¹³.

No. 31. Cornerstone, similar to No. 2¹⁴.
(*Nin.* I, p. 311)

Chamber D

“The two human-headed lions, forming the entrance *d* (chamber B, plan 3), led to another chamber, or to sculptured walls, which, as it will hereafter be explained, may have formed an outward face to the building. The slabs to the right and left, on issuing from this portal, had fallen from their original position, and all of them except one were broken . . .

On the slabs Nos. 2 and 3 was represented the King, holding his bow in one hand and two arrows in the other. He was followed by his attendant eunuch, who carried a mace, a second bow and a quiver for his use. Facing him was his vizir, his hands crossed before him, also followed by an eunuch. These figures were about eight feet high; the relief very low, and the ornaments rich and elaborately carved. The bracelets, armlets, and weapons, were all adorned with the heads of bulls and rams; color still remained on the hair, beard and sandals.

No. 1, forming a corner wall, was a slab of enormous dimensions; it had been broken in two: the upper part was on the floor, the lower was still standing in its place . . . It was a winged figure, with a three-horned cap, carrying the fir-cone and square utensil; in other respects, similar to those already described, except that it had two wings rising from both sides of the back and inclosing the person. Its dimensions were gigantic, the height being about sixteen feet and a half, but the relief was low.

The first slab on the other side of the entrance contained a vizir and his attendant, similar to No. 3. The succeeding slabs were occupied by figures, differing altogether in costume from those previously discovered, and apparently representing people of another race; some carrying presents or offerings, consisting of armlets, bracelets, and ear-ring, on trays; others elevating their clinched hands, either in token of submission, or in the attitude still peculiar to Easterns when they dance. One figure was accompanied by two monkeys, held by ropes: the one raising itself on its hind legs in front, the other sitting on the shoulders of the man, and supporting itself by placing its forepaws on his head. (This relief will be placed in the British Museum). The dresses of all of these figures are singular. They have high boots turned up at the toes, somewhat resembling those

still in use in Turkey and Persia. Their caps, although conical, appear to have been made up of bands, or folds of felt or linen. Their tunics vary in shape, and in the fringes, from those of the high-capped warriors and attendants represented in other bas-reliefs. The figure with the monkeys wears a tunic descending to the calf of the leg. His hair is simply fastened by a fillet. There were traces of black color all over his face . . .” (*Nin.* I, pp. 117–118.)

Appendix:

- “Slab 1. Winged figure, about fourteen feet high, with threehorned cap, fir-cone, and square vessel.
2. Colossal figure of king holding bow and arrows, followed by eunuch, carrying his arms; facing No. 3.
3. Vizir, facing the king (No. 2), and followed by eunuch.
4. Also vizir followed by eunuch.
5, 6, 7, 8. Colossal figures, apparently captives, bringing, as presents or tribute, ear-rings, bracelets, etc. Figure on slab 7, accompanied by two monkeys. All facing entrance *d*.”

(*Nin.* I, pp. 311–312)

(D-9) “The cornerstone (No. 1) was reversed; upon it was a figure with conical cap, apparently made of bands of linen or felt, and already described as represented in the sculptures of chambers D and E (plan 3) (See Vol. I, page 18. The head will be placed in the British Museum). The upper part of the stone (or the lower part of the reversed figure) had been purposely destroyed, the marks of the chisel being visible¹⁵.”

(*Nin.* II, p. 31)

Ninurta Temple Comparison

“I have already mentioned (p. 125) that a superstructure of bricks rested upon the stone basement-wall of the tower, at the north-west corner of the mound. It was against the eastern and southern faces of this upper building that the newly discovered temple abutted. Four of its chambers were explored, chiefly by means of tunnels carried through the enormous mass of earth and rubbish in which the ruins were buried. The great entrances were to the east. The principal portal (Ent. 1.B., Plan II) was formed by two colossal human-headed lions, sixteen feet and a half high and fifteen feet long. They were flanked by three small winged figures, one above the other, and divided by ornamental

¹³ This is B-30.

¹⁴ This is B-31, a “sacred tree”

¹⁵ This quotation comes from a description of reliefs recovered in the Southwest Palace at Nimrūd. Layard goes on to describe other reliefs also “quarried” from the Northwest Palace which were found near this one. These reliefs could have come originally from the “Great Northern Courtyard”, West Wing or Northwest Wing of the palace. See the discussion below and Paley-Sobolewski, *Relief-Representations* II, pp. 65 ff.

cornices, and between them was an inscribed pavement slab of alabaster. In front of each was a square stone, apparently a pedestal of an altar, and the walls on both sides were adorned with enamelled bricks.

About thirty feet to the right, or north, of the lion gateway was a second entrance (Ent. 2.B, same plan), at each side of which were two singular figures . . . This group appears to represent the bad spirit driven out by a good deity; a fit subject for the entrance to a temple, dedicated to the god of war . . .

On the slabs at the right angles to these sculptures, forming the outer part of the entrance, were two colossal human figures, without wings, wearing garlands on their heads, and bearing branches ending in three flowers.

Within the temple, at right angles to the entrance, were sculptured fish gods, somewhat different in form from those in the palace of Koujunjik. The fish's head formed part of the three-horned cap usually worn by the winged figures. The tail only reached to the waist of the man, who was dressed in the tunic and long furred robe commonly seen in the bas-reliefs of Nimroud."

(*Nin. Bab.*, pp. 348–350; illustration of Ent. 1.B, plan 2, is on p. 349)

C. ACCORDING TO MALLOWAN

General descriptions (The "Great Northern Courtyard").

"Until recently it had seemed most surprising that what was so obviously the throne room apparently opened onto a courtyard which according to Layard had been one of the principal thoroughfares into the city. In 1953 however we discovered that the ravine outside chamber B had only been eroded in relatively modern times, and that in fact this courtyard connected it with another wing of the palace further to the north . . ." (*Nim. I*, p. 99)¹⁶

Exterior of the palace (including the throneroom facade)¹⁷

"Along the north wall of the Palace at a point where Layard was known to have dug in the last century, we decided to make soundings in order to discover how much of the sculptured front of the palace had remained intact. Digging was therefore concentrated in the courtyard outside Gate D where we once more uncovered two leonine monsters which had flanked the gate and of which drawings had been published by Layard in the last century. In all we dug out a stretch of about 18 metres of wall-front, as is shown in Mr. Hamilton's plan, the blacked in portion, Fig. 2. The courtyard outside gate D, the second of the two gates in the north wall of the Palace, was found to be paved with burnt-brick, and lying in confusion upon it were many of the great carved stone blocks which had once decorated the Palace façade. A considerable portion of the frieze still survived

although with very few exceptions it was out of its original position, mostly in confusion in the debris of the courtyard itself. To the left of the gate, as one faced it, flanking the courtyard, lay a gigantic fallen bull monster which had originally stood next to a huge Nisroch, part eagle, part man. Two finely carved pieces of relief were found on the façade itself adjacent to it, representing the king's vizier and a youthful attendant with a staff under his arm. These two figures had originally approached the king, the figure of whom was no longer there, but it has been described by Layard. Right of the gate followed two Assyrian figures, the first bearded, and the second clean-shaven, but heavily bewigged, and wearing tabs round his neck; behind them followed a stately procession of tributaries. The tribute-bearers, some of whom wore pointed caps, were foreigners; they carried trays on which were depicted symbols, some of them cruciform, one crescent-shaped, and circular objects which no doubt represented metal ingots. . . . The reliefs also bore the standard inscription of king Aššur-nasir-pal II. The carving was of exceptionally good quality and in fact this façade may be numbered among the best sculpture in the Palace, appropriately enough since it faced the north external front and was one of the principal approached to the king's house. On several figures the black incrustation in the pupil of the eye and the white lime plaster in the iris was still fixed in position, and made the heads stand out very boldly.

It is hoped that eventually the Iraq Antiquities Department may be able to reset this sculpture in its original position, so that the visitor to Nimrūd may be able to see a long stretch of the front of the palace as it was intended to be seen by its founder in the ninth century B.C.

Little material of any interest was found on the floor of the courtyard, but there were traces of cedar-wood which perhaps had originally belonged to the wooden gates. There were also bronze nails and little rosettes which must have decorated the doors themselves, not unlike the rosette-decorations on the Balawat gates of Shalmaneser III. It is to be presumed that the doors themselves had once been heavily overlaid with bronze, probably with decorated figures in relief, but of them nothing remained. The great height of some of the figures — the monsters were no less than 12 feet high — contrasted with the comparative narrowness of the gate. But the entrances were obviously deliberately made small in proportion to the size of the Palace

¹⁶ Mallowan gives no reasons why he thinks the erosion was so recent. Layard saw it and if the stone dado were removed by the kings who built other edifices on the mound, the protective coverings for mudbrick walls would not have been there to help withstand the inevitable "melting" of the architecture and eroding of the mound itself, channels beginning through the stripped gateways of the palace, and ultimately attacking the surfaces of courtyards and the mound itself.

¹⁷ If the throneroom façade faced a courtyard within the palace complex, the description of the external appearance of the palace must be limited to external walls and not to walls of courtyards. External walls were buttressed, but further decoration is not attested.

for purposes of defence. The approach to the Palace may have been up a steep incline which led from the quay on the river, and we were fortunate in discovering a strip of this quay in excellent state of preservation. Unfortunately the original approach to the Palace has been eroded away. There is no possibility of recovering its original surface, but the topography of the ancient roadway which led up from the River Tigris into the Palace is perhaps defined by a well marked *wādī*. After ascending into the Acropolis the visitor could have turned right into the Palace, and left towards the temples on the Ziggurat Terrace. It is evident that the ascent was steep, and Calah would have been well nigh impregnable from the river side unless it were betrayed by an enemy within the gates. To the tribute-bearer in the ninth century B.C. the steep climb up from the river and admission to the great courtyard outside the two gates of the palace wall; the first sight of the long carved stretch of palace-façade was an unforgettable experience, well calculated to strike him with awe. The tale of the brilliance of this royal building must have carried to the furthest confines of the Assyrian empire."

(*Iraq* 15, pp. 28–29)

"The most impressive sculpture of wall was discovered on either side of the doorway leading into the Palace from the brick-paved courtyard E. On the western side of this courtyard we found the fallen bull-man colossus illustrated in *I.L.N.* July 29th, 1950, p. 180, and adjacent to it a fragment of a huge bas-relief of a bird-headed figure carrying a bucket. Layard, it may be remembered, had worked before photography had become of practical proposition, and these and other reliefs were in 1950 photographed *in situ* for the first time. Only by seeing the sculpture in its original setting can one appreciate the masterful vigour of Assyrian carving. The fine photograph of the monumental winged lioness on the frontispiece of the *Illustrated London News* gives some impression of these majestic monuments which, as we hope, will be carefully protected and left *in situ* for posterity."

(*Iraq* 12, p. 181)

"This change of direction between the main area of Z.T. and the Ziggurat and temple-area to the north is of considerable topographical significance, because it means that the Z.T. building was planned as an integral part of the N.W. Palace itself. The discoveries also tend to show that a part of Z.T. 1–31, especially the chambers on the south side of the corridor, may have served as the chancellery to the Palace, for in the eighth century B.C., official archives and the royal correspondence were stored there. . .

The main portion of the N.W. Palace, that is, the part excavated by Layard himself, was obviously devoted to royal functions, for it contained the King's throne-rooms, and in the eastern side there were some smaller chambers which may have been used for religious purposes. Our own discoveries have also shown that the southernmost wing, an extension of the main building, was the domestic quarter and the residence of the harem. Thus the N.W. palace com-

prised three main divisions each of which corresponded to a different function – residential, ceremonial, and administrative." [*Iraq* 16, Pl. 12 illustrates the Plan without the addition of Z.T. It is possible that the smaller chambers J.K.M. were used for the performance of religious offices.]

"Another important piece of information which this work has revealed to us is that the deep ravine which is clearly marked in the contour map opposite the northern entrances to the N.W. Palace in squares H.I.J.K5, down the slopes of which Layard a century ago dragged the colossi, was never one of the entrances to the inner city. Up till 1953 it had generally been supposed that this ravine marked one of the main approaches, but our recent excavations have definitely proved that this was not so." [Thus the statement in *Iraq* 15, Pt. I, p. 30 where a "broad thoroughfare" in K5 is mentioned must not be taken to mean that there was a street in antiquity.] "In fact the main level of Z.T. was more or less precisely that of the throne-room and adjacent chambers of the N.W. Palace itself; indeed the Z.T. building was contiguous to the Palace. The great ravine which is so striking a feature of the site to-day has, in fact, been caused by a continued process of erosion following on the fall and destruction of Calah.

Unfortunately this eroded ravine has inevitably obliterated the evidence of pavements and buildings, and it is therefore impossible to say exactly how the southern extension of Z.T. was adapted to the N.W. Palace proper. [None the less it was still possible to trace across the ravine the remains of the great mud-brick platform built by Assur-nasir-pal as a substructure for the N.W. Palace and Z.T.] But when the contour map of the mound with the additions made in each successive season comes to be published, as we hope, before long, the relation of the two buildings to one another will become plain. Meanwhile it may be said that the north-south axis of chamber 30 is closely related to that of the entrance through gate D to the N.W. Palace. In short, therefore, Z.T. in the main represents the extreme northern limits of the Palace and is separated from it by a forecourt at the same level."

(*Iraq* 16, pp. 116–117)

"We have unfortunately little idea of the external appearance of the palace except on the north façade of the throneroom where we once again unearthed in 1952 the splendid figures of tributaries first seen by Layard and drawn by him 105 years earlier. There, outside the gates, to the accompaniment of the usual colossi, was a picture of the king receiving his general, the turtanu, who preceded the procession of defeated foreigners with their tray-loads of gifts. The prostate bull-man outside gate E who when we uncovered him surveyed the scene sadly from the pavement of the courtyard, has now been re-erected.

No less imposing are the strong colossi which defend the narrow gates; in gate E the human-headed winged lionesses harnessed to the door show how brilliantly the Assyrians succeeded in importing an impression of realism to these fantastic monsters; another pair further to the west (gate

D) guarded the second doorway into the throneroom; these creatures were part man (they had bearded heads), part lion and part bird; each of them carried in his right hand a kid as offering to the gods, and in his left the plant of life.

It is logical to assume that the two gates D and E formed respectively the entrance and exit of the throneroom. The entrance was the furthest removed from the throne itself and the visitor after making obeisance was ushered out from the northern door nearest to the king. The organization of the throneroom in relation to the remainder of the building thus demonstrates that the king himself was easily accessible from the main northern courtyard of the building. No doubt he was properly guarded against assassination, but the royal letters make it quite clear that he was in close personal contact with his people, and it is interesting to find architectural evidence also confirming that he was no remote and secluded figurehead.

The visitor to Nimrud now receives a splendid impression of the original appearance of the external façade and entrances to the throneroom, thanks to the well-executed work of reconstruction which was achieved by the Iraq Antiquities Department. The great stone reliefs, the eagle-headed monsters, and the stone guardians of the gates have been set up in their original positions as intended by Assurnasir-pal himself, to be seen in perpetuity. Most striking perhaps are the two great winged bull-giants, one facing outwards towards the Tigris, the other inwards towards the akropolis, at the entrance and exit to the throneroom. Each of them wears a fish-hood, the symbol of Ea, god of magic, and has the belly of a fish, which became immortalized in the allegorical story of the prophet Jonah. The colossi are in this respect an interesting parallel with the stone reliefs depicting bearded figures wearing long fish cloaks which Layard found in the northernmost chamber of the Ninurta Temple."

(*Nim. I*, p. 103–4)

"Elsewhere the external façades are sadly ruined. The east side seems to have been unadorned; the west overlooked the river which washed the huge stone quays that formed an embankment to the palace."

(*Nim. I*, p. 105)

Superstructure and Arches

Mallowan agreed with Layard's early conclusion that portico-roofing with piers and columns would have obscured the reliefs and because there was no evidence¹⁸. He noted the remains of painted plaster which his excavation (like Layard's) discovered and explained that they came from above: secular scenes and geometrical patterns depicting "a coffered ceiling to which were attached traces of decayed roof beams. It seems possible therefore that the throneroom was roofed with beams of cedar or pine, the undersides of which were brilliantly painted."

(*Nim. I*, pp. 105–106)

"Here, lying on the brick pavement beneath the entrances, were a mass of glazed bricks which had fallen from above the door, into the courtyard. . . .

After reconstruction the panel was found to take the shape of a semi-elliptical Assyrian gate-arch. It stood 4.07 meters high and was 2.91 meters wide at its base. The top of the panel must have stood at least 8 metres above the ground."

(*Nim II*, p. 454 and fig. 373 [p. 453]).

Lighting

Mallowan concluded that the sculpture was ill-lit, having agreed with Layard's early ideas, in this case as well. The walls had been high — eleven or twelve meters high "as we may judge from their thickness, which occasionally amounts to nearly 5 meters." (*Nim. I*, p. 106) Also, doors had been too narrow to let in much light. He admitted to the possibility that there had been clerestory lighting beneath the roof and, with Layard, noted that they would have been closed in bad weather. The lamps discovered in the excavations were too small to have given much light.

D. COMPARATIVE ANALYSIS OF THE SOURCES

Extant remains and the excavators' descriptions are quite clear. Layard's later conclusions about the importance of this façade in the overall scheme of palace decoration have basically stood the test of time, requiring only refinements in details. For example, in recent years, beginning with Reade, scholars have concluded that this façade had originally three entrances, a plan and system that continued to be used by Assyrian architects at Khorsabad and Nineveh¹⁹. This had already been surmised by Layard²⁰. The origin of the three-entrance façade for a single, important (a "throne room"), long room is obscure²¹.

¹⁸ See above, n. 10.

¹⁹ Reade, *Iraq* 27, p. 123, Pl. XXXII; Reade, *Iraq* 30, p. 62 (n. 2); Turner, *Iraq* 32, pp. 181 ff.; Sobolewski, *Palast u. Hütte*, pp. 239 ff., figs. 2–6; Sobolewski, *ZA* 71/II, pp. 253–254, fig. 1; Meuszyński, *Reliefdarstellungen* I, plans 2,3; Postgate-Reade, "Kalḫu" in *RLA* V, p. 311; Paley-Sobolewski, *Relief Representations* II, plan 2; Winter, "Program", pp. 26–7. Reade and Winter took this a step further by drawing attention to the similarity of the subject matter in the throneroom reliefs of other major royal palaces, expanding and refining this notion to include the subject matter of the reliefwork. Reade, "Architectural Context", p. 76. See also an earlier version of Winter's "Program" article, "Royal Rhetoric", pp. 20 ff. and Russell, *Sennacherib's Palace*, p. 76 (n. 2).

²⁰ Layard, *Nin. Bab.*, pp. 138 ff. (See drawings comparing Khorsabad and Nineveh's Southwest palace, opposite p. 136), 654.

²¹ Stretches of courtyard wall with three doorways are known from the Old Babylonian period in the main temple court of the *Kūtūm* complex at Ischali (Jacobsen, "Mesopotamian Temple Plan", pp. 79* ff.; Hill-Jacobsen, *Old Babylonian Public Buildings* I, figs. 2–15, pp. 4–36) and along the south wall of room VII at Tell el Rimah (restoration!). They occur also in the Middle Assyrian palace of Adad-nerari (1304–1273 B.C.) at Assur

This façade, the throneroom façade, faced north and opened into the so-called “Northern Courtyard”²², which was evidently the largest courtyard in the palace complex. On the north and east sides of this courtyard were suites of rooms used for administrative purposes²³. Both of these sets of rooms had doorways giving access to the courtyard and other doors which led outside the palace complex. A third entranceway on the west probably led to another smaller courtyard ringed with more rooms²⁴. A short stump of the western wall of the “Northern Courtyard” is preserved, jutting out at the western end of the throneroom façade about 10 meters beyond entrance B(D)-d. A ravine, now partially filled in by erosion and modern earthwork, cuts across this end of the palace, passing east to west across the building remains, distorting the perspective of the modern viewer. The rooms west of the “Northern Courtyard” seem also to have been destroyed by erosion, which probably began when the palace began to be stripped of its stone wall-façades in ancient times²⁵.

The exact positions of the doorways on the north, east and west sides of this courtyard cannot be established without further investigation²⁶. The positions of these doorways in the reconstructed plan adopted in this volume (Plan 1. *Relief Representations II*) are based upon assumptions made using canons of size and the proportions of walls and rooms in the extant remains of the palace. The positions of the eastern and western courtyard entrances are also based upon the configuration of the ravine, the head of which was originally to the east of the palace, narrowing and/or deepening where the doorways should be²⁷.

The decorations of these entrances on the north, east and west sides of the courtyard and the adjacent façades, can be reconstructed in our imaginations by extending the motifs of the throneroom’s outer façade all around the courtyard. On a clue from Reade based upon an observation by Layard which placed one stray relief fragment on the western wall of this courtyard, the authors have placed this fragment in position D-9 in an earlier publication²⁸.

Full-size figures should then continue, interrupted only by the doorways, all around the courtyard. They should alternate in direction, facing to the right or to the left, depending upon the positions and directions of the royal figure. The subject of the reception scene, so appropriate to the great courtyard at one end of which was the palace’s principal reception suite, might also be intermixed with war and hunting scenes – reliefs in one and two registers such as we know from room B (the throneroom itself), WG and WK and from Khorsabad²⁹. As in court Y, pairs of lion (or lioness!)-colossi should alternate with pairs of bull colossi in every other gateway.

It is the opinion of many authors that the southern façade of the “Northern Courtyard”, that is the throneroom façade, was part of a grand design which Layard could only suggest in the latest of his writings on the subject.

To return to the specific discussion of the courtyard’s southern façade, the available evidence preserves the pre-

cise scheme of decoration only at the eastern and western end of the series of reliefs, and only at two of the three entrances. But, a hypothetical reconstruction of the central doorway and the sculpture adjacent to it can be attempted.

E. RELIEFS IN COLLECTIONS OUTSIDE OF NIMRÜD

All known reliefs outside Nimrüd were identified by Gadd, Weidner and Reade³⁰.

(the doorway positions of the “Old Palace” seem not to have been preserved) and in the temple of Kar Tukulti-Ninurta. The room configurations beyond the doorways differ from those of the Northwest Palace in all cases – the closest being the anteroom-courtyard combination at Mari (Winter, “Royal Rhetoric”, p. 10 after Moortgat, *Art*, figs. 4, 21 and 57) – so these remarks remain hypothetical. The Rimah and Adad-nerari buildings can now be studied in a comparative context in the useful work by Margueron on Bronze Age architecture and dwelling pattern traditions (*Recherches sur les palais*, figs. 273 and 328). In that work there are no other comparable examples. For Kar Tukulti-Ninurta, see now Amiet, *Art of the Ancient N. E.*, fig. 906 and Andrae, *Das Wiedererstandene Assur*, pp. 174 ff.

However, the view from the courtyard side of all of these earlier examples does bear a resemblance to the throneroom façades of later Assyrian palaces. Therefore, the late Assyrian palace façade may have been drawn from architectural tradition and memory because it seemed to be the appropriate frontal scheme for important rooms behind. A large central doorway flanked by smaller ones became the signature for a significant part of a palatial structure – whether the single throneroom or a suite of rooms lay behind. The throneroom suites may have been the invention of Ashurnasirpal’s age and architects, carried forth by later generations.

²² Reade’s “outer court”.

²³ Part of the “ZT Northern Extension”: Mallowan, *Iraq* 15, pp. 28 ff.; Mallowan *Iraq* 16, pp. 66 ff., 115 ff.; Mallowan, *Nim. I*, pp. 164 ff.

²⁴ Access to this northwest corner of the palace is preserved only through a corridor west of room C which runs in a south-north direction from WT, a courtyard facing the Tigris river. The western end of ZT would seem to encompass the northernmost rooms of the Northwest Wing. As the number of palace wings increases in our hypothetical reconstruction, we may yet reach the eight that Ashurnasirpal claims to have built in the complex according to the inscriptions. See Mallowan, *Nim. I*, p. 67, para. 4.

²⁵ Described by Layard and Mallowan, and shown on the topographic map: Mallowan, *Nim. I*, Folding Maps, Plans and Sections, 1. Recent aerial views show this “ravine”: Mallowan, *Nim. I*, p. 105 (fig. 51); Ameen Agha – al Iraqi, *Nimrud*, fig. 5. Previously described by Mallowan, *Iraq* 15, p. 28.

²⁶ In this palace, one of the canon principles in the plan is not to have doorways situated directly across one from the other. This preserved privacy, if desired, in inner rooms of the various palace wings, across palace grounds.

²⁷ See note 24, above.

²⁸ Reade, *Iraq* 27, p. 120 f.; see the Catalogue, below.

²⁹ Both combinations – full size, one-registered reliefs of tribute bearers approaching the king and his courtiers and/or mixed with two-registered (or one-registered) reliefs of war and other royal activities are known at Khorsabad: Albenda, *Palace of Sargon*, pls. 16, 19, 35–37, 40–43, 55–56. The scheme continued at Nineveh. See the recent study of Court VI in the Southwest Palace of Sennacherib: Russell, *Bulls of the Palace*, esp. fig. 4. Winter has suggested that one relief which we have placed in the West Wing (Barnett-Falkner, pl. CXXIV-V=Paley-Sobolewski, *Relief Representations II*, pl. 5:30 [WFL 27], p. 79) belonged in the “Great Northern Courtyard”. If true, this would be the only example that could be attributable to this area of the palace complex.

³⁰ Meuszyński, *Reliefdarstellungen I*, pp. 31–32.

D-2. A-VI-b-i/A-I-e-i (Louvre, Paris 7, AO 19851). King and attendant (→).

D-7. BM 124562. Two tribute bearers wearing boots with turned-up toes and turbans; one with two monkeys (←).

D-9. BM 116930. Upper part of a relief of a man doing obeisance (←)³¹.

E-3. Berlin VA 8747. Upper part of a relief of a man doing obeisance (←).

E-4. Baghdad IM 28143. Midsection of a tribute bearer from the left side of a slab (←).

F. IDENTIFICATIONS AND RECONSTRUCTIONS

Layard reburied most of the sculpture from the façade when he completed his excavations. Some of the sculptures survived where Layard had left them and were discovered when the British resumed excavations under Mallowan more than forty years ago. The pieces that reached Paris, London, Berlin and Baghdad were re-identified by Gadd, Weidner and Reade. There are some fragments missing.

Those that remained at Nimrūd were raised and restored *in situ* by the Iraq Organization of Antiquities. The restoration provides the basis for the hypothetical reconstruction attempted in the pages that follow here. Measurements of the height, width and thickness of all the “*in situ*” sculpture, wall slabs and colossi – including the gigantic colossi that commanded the center of the façade – were taken by the Polish excavators at Nimrūd in the early 1970’s. The seats for doorposts and a threshold from a large central doorway also came to light. These were discovered in the debris, along with the foot of a gigantic lion colossus (Fig. 11). The information gleaned from this new evidence has already been used to produce the text, plates and detailed ground plans of this part of the palace for Meuszyński, *Reliefdarstellungen I* and Paley-Sobolewski, *Relief Representations II*. This reconstruction seeks to go further, this time using comparisons from the relief work of Khorsabad and Nineveh. The reconstruction is documented in the Catalogue.

In general, reliefs associated with the side doorways (d and c – Courts D and E, respectively) were ca. 2.30 m high and were cut with 18-line Standard Inscriptions. The *lamassu*-colossi were ca. 3.10 m high and were cut with a special text, the “Bull-Lion-Altar Inscription”³². The colossal genies were ca. 3.90 m high. The two extant examples were cut with a Standard Inscription in 19 + 1 lines (D-1) and 22 + 1 lines (E-5) respectively. The bull and lion colossi associated with the central doorway – perhaps portal would be a better descriptive term – are no longer extant; they were probably removed in antiquity. We estimate that the side figures were ca. 4.50 m high and those in the doorway corridor itself ca. 4.75 m high. We have, of course, no information about the texts inscribed on these figures, but we might assume that more of the “Bull-Lion-Altar” text, the

fullest extent of which is on the “altar” (actually the throne-base!), would have found its way to these figures because, simply, they were larger and therefore there was more room. This does not *have* to be the case, since the cuneiform signs could also have been larger in size, not all the available space used, and/or the reliefwork could have extended over more of the face of the stone slabs. See the discussions of the inscriptions on ED-1, ED-10 and doorway (F)B-g, below.

We have arranged our discussion according to a perceived pattern of movement and activity in the great “Northern Courtyard”. People with “business” entered the main gate on the east and, if they were on specifically royal business and did pass on through the doorways to the palace’s administrative wings, they would have been ushered around (perhaps waiting in line), to finally arrive in the area of “court” D. They would have, by then, passed by various reliefs which portrayed audience scenes with tribute or tax bearers, royal officials and men doing obeisance, war scenes and perhaps hunting scenes. Before entering into the throneroom, if the visitors had passage that far, the last group of sculptures they would have seen were the first that we can describe, i.e., “court” D. And, if they did not already know the proper protocol, including “body language” (a slight stoop and raised hands), these visitors would have learned by viewing the scenes on the courtyard walls. (The throneroom repeated all this within the confines of a more restricted and probably more immediately intimidating space, because the king was there!) Exiting through “court” E, these visitors would have seen the themes repeated again – “education” and responsibility to the sovereign were constant themes made more relevant by continuous revolt³³.

³¹ See above, note 28. This notwithstanding that it did not come from another courtyard.

³² For this text, see the new edition by A. Kirk Grayson, manuscript, chapter 2, pp. 227ff. All references in the Catalogue below that refer to this inscription by line are to the Grayson edition, which is based upon the lineation of the “altar”. Our thanks to Professor Grayson for providing a copy of his manuscript prior to publication.

³³ For another point of view concerning the participation of the “spectator” in the experience of a palace audience, see Winter “Royal Rhetoric”, pp. 3, 14 and “Program”, pp. 27–8. She has described the throneroom and the southern façade of the “Great Northern Courtyard” (Her courtyard D is a misnomer for the northern courtyard, since that letter is the designation only for its southwest corner.) in reverse of the direction adopted here, that is from the point of view of the king as central, radiating out to his realm, not as approached by his subjects (“Royal Rhetoric”, pp. 16–22, 19–32; “Propaganda”, esp. pp. 24, 29) which is a central theme of the narrative reliefs. However, as she explains, the area around the throne is simply symbolic, in the traditional sense of an Assyrian, Mesopotamian ruler – symbols traditionally and immediately understood by his people: priestly devotee-protector of his realm. It is the ultimate purpose, the culmination of all this visual rhetoric and must be shown as simply and in as straightforward a manner as possible. It is in this manifestation of kingship that he would appear in public squares and in the main courtyard of the palace.

The central doorway was probably reserved for state occasions, including royal processions to the temples, for example, or for public business or spectacle in the “Northern

Courtyard”. Framed by the gigantic colossi which decorated this palatial portal, the king could and did make a forceful propaganda statement by just appearing there.

2. Catalogue

So-called “Court D”

D-9 (–)

Pl. 4.1

London, British Museum BM 118930. Upper part of a figure holding his hands before his face in the gesture of obeisance (←). He wears a turban and has a short curly beard. Only part of the upper edge is original. Because of the angle of his head, shoulder and arms in relation to the upper edge of the stone, he can be said to be bending slightly in deference to the king, as do similar figures in Assyrian sculpture.

Gadd following Layard, repeated by Reade, pointed out that the figure on this fragment, which was found by Layard in the Southwest Palace at Nimrūd with other reliefwork from the Northwest Palace in secondary use, resembled the figures on the façade of court D. Layard described the relief as a reversed cornerstone. We have placed it in position D-9, at the corner where this façade meets the courtyard’s western wall. It could be part of the first slab on the western wall.

Furthermore, if slab D-9 were originally approximate in size to D-8, we should expect more than one figure on the slab. Because the middle figure on slab D-8 is taller than his companions, we expect that – from a compositional point of view – BM 118930, a short figure, is part of either the first or third figure on the original slab D-9, in the procession of tributaries from the left to the right across the stone. That he is shorter is apparent from the distance between the upper edge of the fragment and the top of the turban he wears. The inscriptional evidence also shows that he is the first figure on the left hand side of the slab.

W 0.64 m; H 1.00 m

Middle band. 8 lines of the SI are preserved. The signs are close to the left edge of the original slab; for example:

L. 1:

É. GAL ^mAššur PA]P.A Sanga Aššur . . .

L. 2:

10-ÉR]IN.DAḪ MAN ŠÚ . . .

Bibliography: Layard, *Nin.* II. p. 31; Gadd, pp. 145–6; Barnett-Falkner, p. 25, pl. CXXI; Reade, *Iraq* 27, p. 131; Paley-Sobolewski, *Relief-Representations* II, pp. 84–5, pl. 6.32.

D-8 (W 2.36 m; H 2.30 m)

Pl. 4.1

Complete slab restored *in situ*. Three figures holding their hands before their faces in the gesture of obeisance (←). All wear the same clothes: turbans, fringed robes that are opened in front (the shawl of the middle figure is omitted), bracelets, armllets, counterweighted strings of beads around their necks, earrings and boots with turned-up toes and stepped decoration on the heels. They wear short curly beards, though the center figure’s is longer. He is also shown tallest of the three. The figure on the left is the smallest. There is overlapping: the left shoulder of the figure on the left is covered by the right elbow of the figure in the center; the right hand of the figure on the right overlaps slightly the tasselled counterweight of the figure in the center – though the same tassel overlaps the right figure’s forearm. Even though the bottoms of the robes are in one line, the right boot of the right figure overlaps the left boot of the center figure and the center figure’s right boot overlaps the left boot of the left figure. These are not figures in a single, straight line, but crowded together in a small group. The sense is that the figure on the left is further away from the viewer than the two others who, because they are “intertwined” at one point, have nearly bumped together. The sizes of the figures contribute to the success of this portrayal of a small group of fearful subjects. Perhaps this relief represents, with the others on this façade, the processions of the tributaries in this very courtyard.

Meuszyński noted that the size of the relief seemed too large for the socle. But our records show that the measurements are nearly the same; and, restored *in situ*, the relief fits.

Middle band. Complete SI in 18 lines ending: *ina lib-bi ú-kín*.

Bibliography: Layard, *Nin.* I, pp. 117–118, 311–312; Mallowan, *ILN* 5914, p. 296 f.; Shukri, *Sumer* 12, figs. 7–9 (showing the courtyard); Reade, *Iraq* 27, p. 131; Mallowan, *Nim.* I fig. 48 (a large fragment of the upper part of the relief before restoration); Meuszyński, *EtTrav* XI, p. 10, fig. 2; Meuszyński, *Reliefdarstellungen* I, pp. 31, 33, pl. 5.3; Paley-Sobolewski, *Relief-Representations* II, pl. 6.3.

D-7 (W 2.14 m; H 2.34 m)

Pl. 4.1

The socle is *in situ*. Layard dispatched the relief to the British Museum (BM 124562). Two figures, bending in defer-

ence to the king, are shown on the slab: on the left, a man holding his hands before his face in the gesture of obeisance (←) and, on the right, another leading two monkeys (←). Their beards seem to be as long as that of the center figure on D-8, though the shoulder of the figure on the right cuts his beard off from view. The left figure wears the same garments as do the figures on D-8; the figure on the right wears a short, fringed tunic over which has been draped in an ungainly fashion (Is he shown having difficulty managing his charges?) a fringed robe which hangs to just above the knee in front and to mid-calf in back. Instead of a turban, his hair is held by a headband, wider in front than in the back. One monkey sits on his shoulders, the other stands on the ground beside him with his head turned back. Boots with turned-up toes and stepped decorations on the heels are worn by both figures.

Middle band: Complete SI in 18 lines ending: *ina lib-bi ú-kiñ*.

Bibliography: Layard, *Nin.* I, pp. 117–118, 311–312; Layard, *Mon.* I, pl. 40; Budge, pl. XXVIII; Stearns, *Afo-Beih.* 15, 73 ff.; Gadd, p. 137 f.; Reade, *Iraq* 27, p. 131; Shukri, *Sumer* 12, fig. 7 ff. (showing the courtyard); Ainachi, *Sumer* 12, fig. 10; Meuszyński, *EtTrav* XI, p. 10; Ameen Agha – al-Iraqi, *Nimrud*, fig. 11; Meuszyński, *Reliefdarstellungen* I, p. 33, pl. 5.3; Paley-Sobolewski, *Relief-Representations* II, pl. 6.32. The illustration in Ainachi and Ameen Agha – al-Iraqi is of cast of the original in the British Museum. The cast has been restored on the original socle at Nimrud.

D-6 (W 2.19 m; H ca. 2.30 m)

Pl. 4.1

Restored from fragments *in situ* on the original socle. Two figures are shown (←). The one on the left holds his hands before his face and bends slightly, doing obeisance. He is dressed in the same garments as the figure on the left on D-7 and those on D-8. The figure on the right of this slab is dressed in a knee-length tunic and robe (see the figure with the monkey on D-7), and carries tribute above his head: a long tray upon which are large and small bowls, armlets and a set of jewellery made up of a neckband and two earrings. This figure is smaller. His right elbow is covered slightly by the tassel of the figure in front of him. See above D-8. Sections of the slab are missing across the stone about two thirds of the way up from its base. Both beards are damaged.

Middle band. Standard Inscription, originally in 18 lines. Large sections of the lines of this inscription are missing across the slab right to left as described above. The inscription was originally complete to: *ina lib-bi ú-kín*.

Bibliography: Layard, *Nin.* I, pp. 117–118, 311–312; Reade, *Iraq* 27, p. 131; Mallowan, *Nim.* I, fig. 47 (a fragment from the upper part of the relief before restoration); Meuszyński, *EtTrav* XI, p. 7, fig. 3; Meuszyński, *Reliefdarstellungen* I, p. 33, pl. 5.2.

D-5 (W 2.18 m; H ca. 2.30 m)

Pl. 4.1

Restored *in situ*, the lower third of the relief on its original socle with fragments of a right foot of a figure on the left side of the slab. The head and hands from the same figure and a tray of offerings from the second figure that stood to

his right (←) are on another fragment. A third large fragment has the head and shoulder of that second figure (←). About a third of the total relief is missing and that third has been restored in plaster.

As restored, the figure on the left holds his hands before his face and is slightly bent in the position of doing obeisance. He is dressed in the same garments as the left figures on D-6 and D-7, and those on D-8. The figure on the right is similarly dressed, but he carries a staff (the upper two-thirds is missing, so we do not know if it had a pommel) and a small tray or shallow bowl on which rests a set of jewellery: two bracelets and two earrings. Their beards are as long as that of the figure on the left on D-7, and are shown with ranks of curls.

Middle Band. Most of the SI is missing, but the fragments on the right hand side of the relief preserve the end of 15 of the probable 18 lines of inscription, as would be expected. The inscription was originally a complete SI, ending: *ina lib-bi ú-kín*.

Bibliography: Layard, *Nin.* I, pp. 117–118, 311–312; Mallowan, *ILN* 5914, pp. 296 ff.; Reade, *Iraq* 27, p. 131; Meuszyński, *EtTrav* XI, p. 7, fig. 1; Meuszyński, *Reliefdarstellungen* I, p. 33, pl. 5.2 Shukri, *Sumer* 12, fig. 9.

D-4 (W 1.96 m; H ca. 2.30 m – includes the part that was inserted behind the shoulder of the lion colossus to its left)

Pl. 4.1

Restored *in situ* from three large fragments (Fig. 2). The slab broke essentially in half, but there are pieces missing: about 10% of the right edge of the middle of the stone, including a part of the garment of the right figure with the last third of each line of inscription; a piece of the left figure's garment at knee height; and a bit more of the inscription on the right side at the beginning of the last lines. The surface of the stone along the bottom of the largest fragment (from the upper right part of the relief) is also broken away.

The figure on the left is an official, dressed in an ankle-length and fringed tunic and a shawl that is draped around his waist and over his shoulder. He wears a counter-weighted string of beads around his neck and a crescent-shaped (metal?) piece of jewellery rests on his chest above his wide belt. He also wears armlets, bracelets and earrings. He folds his hands left into right: see the discussion below of the door figures in entrance c. He faces left (←).

The second figure is also dressed in a long, fringed tunic and wide belt. His shawl is draped diagonally across his shoulders and around his waist. The tie cord of his tunic is shown below the strand of beads which hangs around his neck. He also wears earrings, armlets and wristlets. He also faces left (←). He holds his right arm downwards; the palm of his hand turns outwards toward the viewer. These are the hand positions of the herald who introduces the tribute bearers to the king. Neither officer wears a headband.

In contrast to the men on slabs D-5 to D-9, these figures stand upright.

Middle band. The Standard Inscription was originally 18 lines long, but almost a third of it, at the end of each line, is missing. The inscription is broken off at: ŠU-ia šá KUR. KUR(MEŠ) šá a-pe-[lu-ši-na-ni . . .], which is close enough to the end of the SI to say that it was complete to: *ina lib-bi ú-kín*.

Bibliography: Layard, *Nin.* I, pp. 117–118, 311–312; Shukri, *Sumer* 12, figs. 9, 10; Reade, *Iraq* 27, p. 131; Mallowan, *Nim.* I, fig. 49 (the large section of the upper part of the relief before restoration); Meuszyński, *Et-Trav* XI, p. 7, fig. 5; Meuszyński, *Reliefdarstellungen* I, p. 33, pl. 5.2.

(B)D-d-2 (L 3.71 m; W 0.76 m; H₁ 3.00 m; H₂ 3.25 m)

Pl. 1.1; 4.1

Winged lion colossus with human upper torso and head (Fig. 2). The figure wears a full Assyrian beard and long hair which falls neatly on its shoulders, a two-horned helmet and tight-fitting skirt. Its wide belt disappears behind the wing feathers. In its left hand, it carries an animal offering and in its right hand a rosette branch which it holds down against its right leg. There are right-facing genies that hold animals and flowering branches in a similar fashions, supporting the animals under their chests. See the discussion of balanced compositions below, s.v. (B)D-d-1.

The head, face, hair, and helmet of this figure have severely deteriorated since Layard's time, therefore our description must also depend upon his descriptions and drawings. The animal's head was already unrecognizable in Layard's time so that, at one point in his deliberations, Layard thought it might have been covered with metal³⁴. The human seems too small for the massive, powerful leonine body to which it was grafted. This is especially the impression from the side view. In the tradition of the door figures in the palace, this being has five legs. Also, it – like all lion colossi³⁵ – is tethered. There is no indication of sex, which raises the question of whether or not this is a lion or lioness, despite the bearded countenance. Perhaps the artist meant to portray an hermaphroditic monster.

The “Bull-Lion-Altar Inscription” is carved along the side of the figure, on all flat surfaces, between the legs and behind it, as follows:

Behind the figure: The upper left corner of the slab is broken away. The text begins with four eroded signs at the end of two effaced and broken lines and then becomes readable with – (line 4) [..?] TUK-ú mu-šak-niš la kan-šu-te-šú [šá nap-ḥar kiš]-šat ÚKU(MEŠ) i-pe-lu [NÍTA dan-nu] mu-kab-bi-is GÚ a-a-bi-šú da-a-iš [kul-lat K]JUR(MEŠ) mu-pa-ri-ru ki-iš-ri . . . the text is now readable to the end of this section, that is, to: *mu-rib a-nun-te* (line 19) Between the rear legs: MAN ta-na-da-a-te . . . ḥa-si-su pe-et uz-ni ne-me-qi É-a (line 23) Between the middle legs: MAN ZU.AB i-ši-man-ni . . . to . . . am-ḥur-šú-nu a-na KUR-ia Aššur (line 31) Between the forelegs: *lu u-ba-ši-na ina* URU Kal-ḥi . . . to . . . URU Kal-ḥi u É.GAL(MEŠ) KUR-ia ina É e-sir *lu-ú ad-di-šú-nu* (line 34)

Bibliography: Layard, *Nin.* I, pp. 75, 110, 311; *Or. Dr.* III, N.W. XXXIV; Shukri, *Sumer* 12, figs. 9–10; Reade, *Iraq* 27, p. 131; Meuszyński, *Et-Trav* XI, p. 10, fig. 5; Meuszyński, *Reliefdarstellungen* I, p. 33, pl. 5.2.

(B)D-d-4 (W 1.02 m; H 0.98 m)

Slab carved only with a band of the Standard Inscription against which the right door leaf could be swung when the gates were opened. The slab is preserved to just below where the inscription should end. The description of what this slab was like is from Layard (*Nin.* I, p. 311).

Pavements in the entranceway (L 3.21 m; W 2.02 m; L 0.72 m; W 2.05 m)

There are two slabs in this entranceway; one very large one filling most of the area between the door *lamassu*, and a smaller one – like a threshold – against the larger, on the side of “court” D. The larger one is cracked in half. They are both so badly effaced that only a few signs survive. Laessøe once wrote that the inscription in this entrance was the SI. A few signs survive with what appears to be a metallic inlay which has not been analyzed. A few other signs survive along the left side of the stone next to B(D)-d-1. The nature of the inscription cannot be confirmed.

Bibliography: Laessøe, *People of Ancient Assyria*, p. 102; and information courtesy of John M. Russell.

(B)D-d-3 (W 1.02 m; H 0.98 m)

Slab carved only with a band of the Standard Inscription against which the left door leaf could be swung when the gates were opened. Like B(D)-d-4, the slab is preserved to just below where the inscription should end. The description is known, therefore, only from Layard's remarks (*Nin.* I, p. 311)

(B)D-d-1 (L 3.70 m; W 0.72 m; H₁ 3.00 m; H₂ 3.25 m)

Pls. 1.1; 4.1; 4.5

The companion figure to B(D)-d-2 and like it in all details except that it is attached to the other side of the doorway so that the relief is on the front and right side of the stone. The animal is carried in its left arm and its right holds the rosette flower branch down against its right front leg (Fig. 1). For balance, we might have expected the animal to be held in the right hand and the rosette in the left. Compare the discussion of B(E)-c-1 and B(E)-c-2, below. This is an interesting anomaly for which we have no explanation.

There has been severe deterioration of the helmet, head, hair, beard and face of the figure. Actually, most of the head has broken away. The animal is not identifiable and has been nearly so since Layard's time. Drawings in *Mon.* I

³⁴ Layard, *Nin.* I, p. 110.

³⁵ This excludes, of course, the lions of the Ishtar Temple: Layard, *Nin. Bab.*, pp. 358–9; Budge, pl. VI; Ameen Agha – al Iraqi, *Nimrud*, fig. 8 (the companion to the lion in the British Museum).

and *Or. Dr.* III, N.W. III suggest a lamb though in his short appendix-descriptions, Layard identified it as either a stag or a ram (see above, p. 7). We rely here on Layard's published drawings to reconstruct the missing details. The inscription is carved along the side of the figure, between the legs and behind it, as follows:

Between the front legs: (É). GAL .. to .. (eroded)

¹⁰SIPA *tab-ra-te*

Between the middle legs: *la a-di-ru* GIŠ.LAL .. to ..
a-di ^{uru}*Hi-ri-mu*

Between the rear legs: ^{uru}*Ha-ru-tu* .. to .. *ši-it* ^d*Šam-ši*
(line 21)

Behind the figure: The top left corner of the slab is broken off. The text resumes with a few eroded signs:

(Line 24) *šá* A[N-e ù KI-tim ...] *ú-d*[*u-ni-ma* MAN-ti ...] *ina* K[A-šú-nu KÙ *ú-ša-a* ...] *u* *hur-šá-ni* *d*[*an-nu-te* ...] *ù* *šá-pa-ri* [...] *ina* *qf-bit* *Aššur* EN GA[L-e ...] ÁGA SANGA-*ti-ia* *a-n*[*a* ^{kur}*Lab-na-na*] *lu-ú a-lik* ...

The text then continues broken; only a few signs are missing at the end of each line on the slab, until the text becomes continuous again on (line 32) *ú-šab-ri ina ti-ri-ši ŠU-ia ú šu-uš-mur* ... and ends: *ina* ^{gis}*pu-aš-ḫi a-duk* (line 42).

Comparing the other exemplars, there are minor variants: numbers vary, some of the MEŠ signs are excluded as well as some of the items innumeraled in the lists of tribute and animals for the zoo and hunt.

Bibliography: Layard, *Nin.* I, pp. 75, 110, 311; Layard, *Mon.* I, pl. 42, left; *Or. Dr.* III, N.W. III; Mallowan, *JL N* 5914, pp. 296f.; Shukri, *Sumer* 12, pls. 9, 10; Reade, *Iraq* 27, p. 131; Meuszyński, *EtTrav* XI, p. 10, fig. 4.

D-3 (W 1.97 m; H ca. 2.30 m – the width measurement includes the portion that was placed behind the shoulder of B(D)-d-1) Pl. 4.1

Restored *in situ* from several large fragments into its original base (Fig. 1). Two royal (army) officials (←) stand before the king (on D-2), hands folded, right into left. Both are dressed in long, belted tunics with fringed bottoms and a band of fringe on the shoulders (a shawl?), and the conventional sandals. Each figure wears one crescent-shaped piece of jewellery which hangs on his chest, counterweighted strings of beads, earrings, armbands and bracelets. The official on the left carries a sword; the one on the right, a staff. The headband of the left official is wider in front than in the back and is tied in a knot at the back of the head; the remainder of the material hangs down his back and ends in fringes. The official on the right has a different headband made of what might be a folded piece of cloth which looks like a cord holding a triangular piece of material in place.

Middle band. The Standard Inscription is in 18 lines. Most of the missing pieces of the relief come from the break line which crosses the inscription. However, enough

is preserved to show the number of lineations and that the inscription was complete to: *ina lib-bi ú-kín*.

Bibliography: Layard, *Nin.* I, pp. 75, 311–312; Shukri, *Sumer* 12, figs. 7–10; Reade, *Iraq* 27, p. 131; Reade, *Iraq* 34, pp. 87ff.; Mallowan, *Nim.* I, figs. 45, 46; Meuszyński, *EtTrav* XI, p. 7, fig. 4; Meuszyński, *Reliefdarstellungen* I, p. 33, pl. 5.1.

D-2 (W 2.19 m; H 2.30 m)

Pl. 4.1

In situ, completely preserved socle.

The upper part of the relief was described by Layard and identified as Paris 7 (AO 19851: A-VI-b-i/A-I-e-i) by Reade. There are two figures on the Paris piece, which comprises the upper two-thirds of the stone (the lower third of the relief, above the socle, is missing): an arms bearer on the left and the king on the right (→). The arms bearer wears a long tunic fringed at the bottom, and a shawl draped across his middle and over his left shoulder. He has armbands, bracelets, earrings, and a beaded necklace with counterweight. His hair is held with a band tied behind the nape of his neck. He holds a bow on his shoulder in his left hand. It, and its quiver, are strung over his left shoulder. He also carries a sword. In his raised right arm is a flywhisk which he holds just behind the king's head. The king is dressed in a long tunic, fringed at the bottom, and a wide robe or shawl draped over his lower body, its corner thrown over his left shoulder. He also wears the royal polos, tied with a head band, the end of which hangs down his back. He has armbands, earrings, bracelets, a counterweighted necklace of beads, two knives in his belt and a sword on his left side. He sets his bow in a "parade rest" position with his left hand, and two arrows are held aloft in his right hand as a sign or gesture of triumph reserved for the end of a battle at the presentation of prisoners, booty or tribute. This is the way he holds his arrows in the war reliefs of the throneroom (B-18, B-7 – where the bow is not at parade rest: there is perhaps no cease fire yet?). For the bow held at "parade rest", see the reliefs in rooms G and H³⁶. Paris: W 2.15 m; H 1.63 m

Middle band. The inscription is completely preserved, an 18-line SI ending: *ina lib-bi ú-kín*.

Bibliography: Layard, *Nin.* I, pp. 117–118, 311; Pottier, *Catalogue*, pp. 58ff., pl. V; Reade, *Iraq* 27, p. 131; Meuszyński, *EtTrav* XI, p. 7; Meuszyński, *Reliefdarstellungen* I, p. 33, pl. 5.1. Gadd, pp. 200f. and Stearns, *AFO-Beih.* 15, pp. 72f. identified this relief with B-14, which is still at Nimrud and depicts an armsbearer and the king holding his staff of rulership³⁷.

D-1 (W 2.44 m; H 4.50 m)

Pl. 4.5

A nearly complete restoration *in situ* of a gigantic 4-winged genie (←), carrying a bucket and cone. He wears a 3-horned helmet with an open, flower-shaped spike on top. This spike is found on helmets of genies in room B. See E-5

³⁶ Meuszyński, *Reliefdarstellungen* I, pls. 1.3, 2.3, 8ff.

³⁷ Meuszyński, *Reliefdarstellungen* I, pl. 2.1.

below, which has been restored, based upon this figure. Except for size, the genie resembles others in the palace. He also wears armlets, bracelets, earrings, a counter-weighted, beaded necklace, knives and a whetstone. There seems to have been some confusion about the height of this figure in Layard's various descriptions of courtyard D.

Middle band. A few signs from the first line of the inscription are broken away, but the rest is complete in 19 + 1 lines to: *ina lib-bi ú-kín*. The inscription's band is carved from mid-thigh to mid-calf.

Bibliography: Layard, *Nin.* I, pp. 125-6, 311, 385-6; Shukri, *Sumer* 12, figs. 7-10; Meuszyński, *EtTrav* VI, p. 28, fig. 1; Meuszyński, *EtTrav* XI, p. 7; Meuszyński, *Reliefdarstellungen* I, pp. 32-33, pl. 5.1.

ED-10 (L 4.94 m; W 0.80 m; H₁ 4.50 m; H₂ 4.80 m)
Pl. 3.2; 4.1; 4.5

Restored *in situ*. About two-thirds of the figure survives: most of the wings, head and front of the figure (Fig. 7). The rear legs (except for one fragment of the tail and hock) and the lower half of the left front leg as seen from the side view, the back, and most of the belly are missing. This winged colossus is special. It has human, bull, bird and fish attributes. The three-horned helmet has been described as a "fish-hood". The beast's ears are fish fins, and its belly is carved with the profile of a fish body. Mallowan, after Layard, drew attention, again, to the parallel of human figures wearing "fish cloaks" in the Nunurta Temple at Nimrūd.

The figure is one of the largest bull *lamassu* on the mound, appropriate to the central doorway motif to which it belongs. See the discussion which follows. The bull can be reconstructed completely because of the restored example, ED-1; see below.

Most of the "Bull-Lion-Altar" Inscription is missing. There does not seem to have been any inscription carved behind the figure on the stone slab. What remains is between the front legs, as follows:

(line 32) ŠÚ-ia ú šu-uš-mur ŠÀ-ia . . to . . ana ma'-diš ú-ša-li-di (line 35)

Then the first signs of the next lines are either eroded away or broken off. Then there is a triangular piece missing which results in the following:

- X. UR mi-in-di-na-áš TI.LA(MEŠ) ina SU (MEŠ)
X+1. ú-šab-bi-ta su-gul-lat GU₄ AM(MEŠ)
X+2. [AM.SI(MEŠ)² UR.MAḤ] (MEŠ) GÁ.NU
MUŠEN (MEŠ) pa-ge-e pa-ša-a-t[e]
X+3. [ANŠE.EDI]N.NA(MEŠ) MAŠ.DÀ(MEŠ)
DÀRA. MAŠ(MEŠ) a-sa-[a-te(MEŠ)]
X+4. [ni-im-ri(MEŠ) se-en-ku]r-ri(MEŠ)
nu-š[e-ni(MEŠ) ú-ma-]am
X+5. [EDIN KUR-e DÜ-šú-nu ina URU-ia^{uru} Kal-ḫi lu-ú
ak-šur] ÛKU(MEŠ)
X+6. [KUR-ia DÜ-šú-nu ú-šab-ri NUN-ú EGIR-ú in]a
MAN(MEŠ)-ni

- X+7. [DUMU(MEŠ)-ia ša Aššur i-na-bu-šu lu-ú]
ÛKU(MEŠ) EGIR(MEŠ)
X+8. [lu-ú LÚ um-ma-an MAN lu-ú LÚ GAL-ú] lu-ú
LÚ šá-SAG
X+9. [la ta-ia-pil ina pa-an Aššur ZI ši-i TI⁹NIN.URTA
X+10. [ù⁹IGI.DU šá SANGA-ri] ÁGA-mu MÁŠ
ANŠE.EDIN
X+11. [ú-šat-li-m]u-ni e-peš ba-'-ri iq-bu-ni
X+12. [30 AM.SI(MEŠ)] ina šub-ti a-duk (line 41).

Bibliography: Layard, *Nin.* II, pp. 88, 92; Ainachi, *Sumer* 12, fig. 7, 9; Shukri, *Sumer*, 12, fig. 1, 7, 8, 13; Laessøe, *People of Ancient Assyria*, fig. 5; Crawford-Harper-Pittman, fig. 6; Mallowan, *Nim.* I, pp. 103-104; Meuszyński, *Reliefdarstellungen* I, pl. 5.1.

Since there were virtually no remains *in situ* in the 19.90 m. long space between the bull colossi ED-1 and ED-10, the following reconstruction remains speculative.

There must have been a doorway here, an educated guess originating with Layard and to which most scholars agreed, especially once it was known that the British and Iraqi expeditions had discovered a threshold, door post seats from a double-leaved door and a paw from a colossal stone lion in the debris (Fig. 11), while clearing room B (the throneroom) and "courts" D and E³⁸. The discoveries were made in an area so poorly preserved that Layard had not been able to follow the remains properly. The lion's paw was so large (ca. 0.15×0.35×0.35 m), that it had to have come from a figure at least as large as ED-1 and ED-10³⁹.

In sum, there was the following evidence for a reconstruction of this façade:

1. The space between the back of ED-1 (←) and the back of ED-10 (→) was large enough for a grand, central gate design (ca. 19.90 m×7.50 m or 150 square meters).
2. The thresholds and seats of the gate were extant.
3. There was a lion paw from a gigantic gate figure, which meant that at least two such figures once existed as part of the central façade's decoration. *Lamassu*-figures generally come in pairs, and certainly in the palace.

With Layard's idea that this façade had three entrances confirmed, it is now possible to develop his observations further, including the use of his Khorsabad and Nineveh parallels more specifically.

The reliefs in positions E-4 and E-5, and D-1 and D-2, which lined the corners of the western alcove of court E and the eastern alcove of court D, respectively, were not erected at 90° angles to one another or to the line of the north wall of room B. The north wall of room B runs in an east-west direction. The buttresses which flanked the central doorway were rhomboid in layout. This was a powerful structural concept; the result was massively protective in a

³⁸ The first generally known plan was Reade's (*Iraq*, 27, pl. XXXII); Sobolewski, *Palast u. Hüte*, pp. 241-3, figs. 3-5; Sobolewski, *ZA* 71/II, p. 253, esp. note 10.

³⁹ Reade, *Iraq* 27, p. 131.

physical sense. The brickwork had to have been carefully conceived and considered. Practically speaking, the mass of bricks of the walls and the buttresses that made up this façade were needed to support high walls, an imposing arch and probably a second floor or roof promenade⁴⁰.

A rhomboidal layout of the buttresses also meant that some interesting results (or solutions) were devised by the artists who were planning the decorations for the façade. Suspending discussion of the reconstruction of the central doorway for a moment, if one stands back from the façade and views the extant doorways *c* and *d* and their “courts” E and D, respectively, one immediately notices that all the reliefs are not visible. It seems as if the figures on the reliefs are emerging from hidden doorways and halls: the left figure on slab D-2 is partly hidden by the bull ED-10, the tribute bearer on the right of slab E-4 is partly hidden by the bull ED-1, and the tribute bearer on the left of E-1 is partly hidden by the northern wall and corner of alcove EA. Published photographs of the façade support this, as do our drawings. The artists and architects that worked together to conceive the façade’s arrangement (of course, with royal approval) were successful not only in portraying the relevant motifs but also in manipulating them in such a way that the scenes and the architecture work together in a single grand design: solid power and the associated relevant human activity⁴¹.

The next step in our hypothetical reconstruction is to determine just how the decorations of the central part of the façade – which we now knew existed – fit, and to reconstruct from parallels what was missing⁴²: that is, to divide up the space among the two postulated lion-colossi, the door thresholds, the doorpost seats, the mudbrick walls and the buttresses, before proceeding with further hypotheses.

The thicknesses of the walls were known from the existing remains, especially because the positions of the *in situ* slabs and *lamassu* of “courtyards” D and E were evident in the excavation. The lengths of the wall and the buttress segments between door *c* and the new door (“*e*”) and that new door and door *d* were computed by first positioning the doorpost seats and thresholds along the southern face of the northern wall line of room B⁴³. An assumption was made that the center of the new door *e* was equidistant from doors *c* and *d*, respectively – that is approximately at the 9.96 m point. Then a measurement was taken across the seats and the threshold from the inner edge of the doorpost hole of each seat. This determined both the width of the doorway – in any other configuration, the door leaves would not fit the space properly – and the positions of the inner side of the slabs (the *lamassu*) that must have lined the entranceway facing the new “court” ED. The measurement was 3.40 m (Plan 4).

Estimates were also made – as has been noted above – about the sizes of the lion-colossi, that they were at least the same size as the bull-colossi (L ~4.94; W ~0.85; H₁ ~4.50; H₂ ~4.80). (Drawings in this volume were made

based upon the iconography and proportions of human-headed lion-colossi elsewhere in the palace, eg. B-a-1 and B-a-2, but at the scale size of the bull-colossi ED-1 and ED-10). However, before positioning these lion-colossi, other points had to be considered: the amount of space, if any, between each bull-and lion-colossus – which we assumed would be standing back to back against the mudbrick buttresses – and what was in the space between each lion and bull. Subtracting the lengths of the lion-colossi and the width of the doorway on the court side from the total linear distance available (4.94 m×2+5.80 m), left 4.24 m. This was enough for two colossal genies (ED-2 and ED-9) estimated to be approximately the same size as either E-5 or D-1, which could be positioned between each lion and bull and the widths of two colossal *lamassu* (ED-e-1 and ED-e-2) that would have lined the new doorway *e*. Offering bearer-type genies (A-III-types) were chosen for the former positions. This type is often associated with doorways in the Northwest Palace and similar figures continue this tradition at Khorsabad and Nineveh⁴³.

Some assumptions were made:

1. that the central doorway was approximately in the center of the façade;
2. that the colossal *lamassu* that lined the entranceway of the central doorway would have been larger (taller, broader and longer) than any other *lamassu* in the façade. Even in this assumption we had the support of comparisons with Khorsabad and Nineveh⁴⁵;
3. that, based upon the principal of the alternating lion-and bull-colossi around other rooms and courtyards in the palace (eg. courtyard Y), the *lamassu* in the entranceway (ED-e-1 and ED-e-2) would have been bull-colossi; see room B, doors *a* and *c* (From the perspective of room B, this principal does not seem to work. However, the lions in entranceway *d* are different and do face court D.);

⁴⁰ Sobolewski, ZA 71/II, pp. 253–4; see below, notes 49, 53.

⁴¹ With the inscriptions even more so: see Porada, *Late Assyrian Reliefs*, p. 240. The realization of the importance of the façade as part of the “Great Northern Courtyard” originates with Mallowan, and has been repeated by Oppenheim (*Ancient Mesopotamia*, p. 328), Reade (*Loc. cit.*) and Winter (*Loc. cit.*).

⁴² Winter’s terminology “the incorporation of conventional units into extended sequences” which describes a process of combining “stock images” into narrative sequence (“Royal Rhetoric”, p. 11 and p. 33, note 5) has its parallel in the symbolic sequences of repetitive figures which can be described as “modular”. This is why this restoration can be attempted.

⁴³ Such as they were at Khorsabad: Loud, *Khorsabad I*, figs. 71, 82. See also the discussion in W. Andrae, *Das Gotteshaus*, p. 32 and fig. 25, an illustrative isometric drawing.

⁴⁴ Nimrud: Meuszyński, *Reliefdarstellungen I*, pl. 1.1 (B-26a and B-26), pl. 3.2 (B-30 and B-29). Nineveh: Southwest palace, Room I façade = *Or. Dr.* I, 33 in Russell, *Bulls for the Palace*, fig. 3. Khorsabad: Albenda, *Palace of Sargon*, pls. 15–17, 40, 63 (z facing away from the doorway) and passim without animal offering but carrying a floral branch. Cf. Russell, *BASOR* 276, p. 90, note s.v. p. 101 (rev. of Albenda, *The Palace of Sargon*).

⁴⁵ Khorsabad: Loud, *Khorsabad I*, fig. 45 (Court VII: a reconstruction); Albenda, *Palace of Sargon*, pl. 16 (a reconstruction).

4. The bulls in the new entrance *e* were so long that there was no room for plain, inscribed slabs behind them on the room-B side such as there were behind B(E)-c-3 and -4 and B(D)-d-3 and -4. This also meant that the positions of the seats and thresholds could really be inside the line of the north wall of room B as was suggested above⁴⁶.

If the widths of the slabs with the A-III genies (ED-2 and ED-9) were adjusted downward, these computations worked well with the assumptions. Therefore, the sizes of the genies were estimated at 2.12 m. The computations $2.12 \text{ m} \times 2 = 4.24 \text{ m}$ equalled the space available. It must be emphasized here that all the sizes were estimated, but the general scheme seemed logical.

The next problem in the reconstruction was the nature and arrangement of the alcoves which flanked the bulls of the central doorway in the new "court" ED – to continue in the style of Layard's nomenclature. As noted above, the layout of the buttresses was rhomboidal: that conclusion was based upon the positions of the socles of slabs E-4 and E-5; D-1 and D-2, and the oblique angle established for slabs ED-4 and ED-7 against slabs ED-5 and ED-6, respectively. The motif adopted for these two reliefs duplicates that of E-5 and D-1 – that is, 4 winged genies with bucket and cone⁴⁷.

This left the space between the right edge of ED-4 and the bull-colossus ED-e-1 and the equivalent space between the left edge of ED-5 and the bull-colossus ED-e-2. Three solutions to the decoration of these two slabs were possible:

1. Inscribed slabs with non-figural decoration;
2. Slabs with two genies (human-headed of two varieties, or one human-headed and one bird-headed) placed one above the other in a two-registered relief with either a cornice decoration or an inscriptional band separating the upper figure from the lower. There are parallels for this type of composition in the Northwest Palace as well as at Khorsabad⁴⁸.

3. Slabs with three registers of genies (mixed human-headed types or with human- and eagle-headed types), probably with a cornice decoration between the registers (presented on Pl. 4.3 in our reconstruction). There would be no room for an inscription. For this suggestion there are the closely examples from the entrance to the Ninurta Temple at Nimrūd, as well as at Khorsabad and Nineveh⁴⁹.

The decorated (or undecorated) slabs would have been arranged symmetrically on the two sides of the entrance-way on the façade of the alcove.

One of the figured-relief solutions is preferred, if only because of the fact that this is the main door of the throne-room, the most important single "show" door known in the whole palace complex. Also, genies mean that more protection is afforded to the doorway and more figures mean that attention is drawn to the entrance as being more important than the others were⁵⁰.

It is also important to remember that people looking in the direction of this entrance from the "Great Northern Courtyard" would presumably also be able to see slab

B-13, which stood opposite the entrance on the south wall of the throneroom. B-13 is a slab that duplicates the motif of part of slab B-23, the relief that stood behind the throne of the king. The figures on both B-13 and B-23 are carved in a pseudo-niche, that is, within a framed border which was probably finished in an arch in the brick and plaster work above the slabs⁵¹. The motif is the well-known scene of kings! and genies! symmetrically arranged on both sides of the "sacred tree". Therefore to look through this doorway, gave a view of "kingship" equivalent to that in the company of the enthroned king⁵². This observation supports a conclusion that compositions were well-placed everywhere in the palace, even uniting one architectural space with another (room and courtyard, room and room), to arrive at a total effect. This arrangement emphasized a particular role in which the king wanted to be portrayed, not only in the throneroom but also in the courtyard: the royal figure as priestly devotee and protector of the realm. The suggested height of the central bull-*lamassu* (~4.75 m) requires a relief next to it that would reach at least as high as the top of the second horn of their helmets. The three-figured relief idea could accomplish this easily, but a two-figured relief is also possible as follows:

Two genies formerly in Bryn Athyn and now in the Shelby White-Leon Levy collection, may belong to such a composition⁵³. There are several characteristics which make them attractive candidates for the reconstructed doorway façade.

⁴⁶ See n. 43.

⁴⁷ For a parallel at Khorsabad, see Loud, *Loc. cit.* (above n. 45).

⁴⁸ Nimrūd: Paley-Sobolewski, *Relief-Representations* II, pl. 3, 11, 12 (S-26 and S-27). Khorsabad: Albenda, *Palace of Sargon*, pl. 36, *porte p* and *porte Q*.

⁴⁹ Ninurta Temple: Layard, *Nin. Bab.*, pp. 348–9 (with illustration). Khorsabad: Albenda, *Palace of Sargon*, pl. 56 (*Façade m*). Nineveh: Russell, *Bulls for the Palace*, fig. 4 (court VI).

⁵⁰ We thank Professor Edith Porada for this observation.

⁵¹ Sobolewski, *ZA* 71/11, pp. 253–4, with reference to the painting from room 12 (the throneroom) in Residence (palace) K at Khorsabad: Loud-Altman, *Khorsabad* II, pp. 83 ff.; pl. 88; also pl. 44 (Nabû Temple) and pl. 85 (court I and court II). Note that the restorations are based upon a perceived notion of the height and shape of the arch. The shape of the 8th ce. B.C. arch can only be restored from the 19th century discovery recorded by Place: Sobolewski, "Palast u. Hütte", p. 244 (fig. 6). For the shape of the 9th century arch see, perhaps, the restored brick decoration from Fort Shalmaneser: Reade, *Iraq* 25, pp. 38 ff., pl. IX, and Mallowan, *Nim. II*, pp. 452–455, fig. 373 and the discussion below. The elevation of a restored west gate in Fort Shalmaneser (Mallowan, *Nim. II*, fig. 375) resembles the Khorsabad examples.

⁵² Winter has noted that the reliefs on B-13 and B-23 were carved about one-third of the way up the slab "in their own unique disposition of space, visually apart from the others" ("Royal Rhetoric", p. 10). There is a practical reason, as well as a "rhetoric"-communicative-symbolic and aesthetic reasons, for this. The figural decoration of B-23 was the backdrop behind the royal throne raised on a base above floor level; that on B-13 was more visible at a distance, as an identifiable unit through the central doorway, than it would have been had it been carved at the level of the other reliefs.

⁵³ von Bothmer, *Glories of the Past*, pp. 36–7, items 23 (article by Erika Bleibtreu).

1. There is no inscription carved on either of them. This is also true of some of the many smaller reliefs from slabs in two registers from other rooms in the Northwest palace and from the door of the Ninurta Temple.

2. The genies carry a bucket with a special decoration. Such genies are often placed next to doorways.

3. It is not certain that they were part of a single composition with a sacred tree between them. The reliefs have been trimmed, cutting off the wings and helmet of one, the wings of the other, and the socles of both. The right-facing genie's slab should have had at least the top of a tree frond on the right edge of the slab.

4. The reliefs are presently 0.65 m wide. Restoring the wings and adding to the stone in front of both figures so that the slabs could fit behind the shoulder of the door-*lamassu*, could increase the width of each to over 1.00 m, nearly what is needed in the spaces ED-5 and ED-6.

5. The heights of the slabs are 1.55 m and 1.62 m respectively. Double those heights for other human or eagle-headed genies, add a full socle and an inscripational band between the upper and lower figure on each slab, that is ca. 1.00 m, and the slabs would be nearly the height needed for the spaces under discussion.

No mention has yet been made about the arches that sprang from above the reliefs E-2 and E-3 over door *c*, above ED-5 and ED-6 over door *e*, and above D-3 and D-4 over door *d*. That there were arches is evident from the painted brick fragments found by the excavators in the debris in the doorways. The Iraqis have attempted a restoration of an arch in door *f* of courtyard Y which leads into room F (see below). This seems actually to have been an ad-hoc restoration made with various painted and glazed brick fragments, created as much for the purpose of giving an idea of another archway in the palace as for protecting the poorly preserved bull-colossi found in the doorway. The angle of the arch may be inappropriate; the arch should have had another rank of bricks supported by the tops of the *lamassu*-slabs. This seems to have been impossible given the weakness of the colossi⁵⁴. Ninth century BC Assyrian arches should be more straight-sided and taller appropriate for the narrow doorways⁵⁵. From the little evidence we have, the arch restored in door *f*, courtyard Y, may be more Sargonid in style⁵⁶. But this is unsure: Sargon did restore the Northwest Palace and may have altered the brickwork, the evidence for which may have given further reason for the present reconstruction. Arch restoration in entranceways *c* and *d* of the throneroom façade have also been made as part of the efforts to protect the sculptures from the environment, but these arches are pure fabrication.

What is interesting and important for the reconstruction under discussion here is the way these arches were built. They were with bricks supported from both ends – both by the mass of bricks of the adjacent wall and the tops of the entranceway slabs. Also, if the arches were straighter and higher, as we suggest ninth century BC arches should be,

the top of the arch could have been two or more times as high as the height of the *lamassu* in the doorways. In the case of doors *c* and *d*, this could be over 6.2 m; in the case of door *e*, 9.5 m! In fact, a restoration of the façade of the throneroom of the Northwest Palace might approach the scope of the restoration envisioned by V. Place for the Sin Temple at Khorsabad⁵⁷ or Loud and Altman for the Nabu Temple at the same site⁵⁸.

This hypothetical discussion concludes with the continuation of the catalogue, as follows:

ED-9 (W ~2.12 m; H ~4.50 m) Pl. 3.2; 4.1

4-winged, human-headed genie wearing diadem or “garland” (←). The figure holds an animal in its left hand and a flowering plant in its lowered right hand. This is a variant combining genies holding plants in downward positions and those holding them aloft and carrying animals. The downward position of the hand was decided on because it was felt that, with a 4-winged composition (a continuation of the idea that all the genies associated with this portal and the adjacent façades should have four wings as do E-5 and D-1), the plant would have had to be cut totally over an up-raised wing (a confusing image) and the composition would have been totally unbalanced. The parallels depicting genies holding plants and animals are all 2-winged.

Bibliography: Genies with plants only (rooms S and Z) – Paley-Sobolewski, *Relief Representations* II, pls. 3.11,13,14 (cf. 16); 4.22.20. Genies holding plant and animal (Rooms B and S) – Meuszyński, *Reliefdarstellungen* I, pls. 3.2;4.21.

ED-8 (L ~4.94 m; W ~0.85 m; H₁ ~4.50 m; H₂ ~4.80 m) Pl. 3.2; 4.1; 4.4

Gigantic lion-colossus (←). Prototype from room B, door *a* and courtyard Y, door *b* (room G). With three-horned helmet.

Bibliography: see below, the room B and courtyard Y discussions.

ED-7 (W 2.40 m; H 4.50 m) Pl. 4.4

4-winged genie. Prototype, E-5 and D-1. (→).

Bibliography: See E-5 and D-1, s.v.

ED-6 (W ~1.40 m; H ~4.75 m) Pl. 4.3

Two- or three-registered relief with small genies (←) and perhaps a Standard Inscription. Prototypes: Ninurta Temple façade, Khorsabad and Nineveh.

Bibliography: See the discussion above, p. 19, n. 53.

⁵⁴ Sobolewski, *Palast u. Hütte*, fig. 10 (Nimrūd).

⁵⁵ There remarks are based upon comparisons of the arches noted above, note 51, and below, note 56.

⁵⁶ Sobolewski, *Palast u. Hütte*, fig. 6 (Khorsabad, entrance 3 – an A.D. 19th century photograph from Pillet, *Un pionnier d'assyriologie*, Victor Place, p. VII; Loud, *Khorsabad* I, figs. 3–5).

⁵⁷ Loud, *Khorsabad* I, fig. 99.

⁵⁸ Loud and Altman, *Khorsabad* II, fig. 44.

ED-e-2 (L ~5.20 m; W ~0.80 m; H₁ ~4.75 m; H₂ ~5.00 m) Pl. 2.1; 4.1; 4.3; 4.4

One of the pair of the largest bull-colossi in the palace (→). Prototype: room B, door *b*; courtyard Y, doors *f* (room F) and *e* (room S).

Bibliography: See the discussion of room B and courtyard Y below, pp. 26 ff. and 32 ff.

Pavement slab(s) between the colossi (W ~3.40 m; L ~5.20 m)

No evidence has survived of the stone(s) themselves. See below, s.v. Doorseats and threshold.

Doorseats and threshold (Right doorseat: W ~1.17 m; L ~1.79 m; Threshold: W ~0.88 m; L ~2.56 m; Left doorseat: W ~1.17 m; L ~1.79 m) Plans 1; 4.

Fragments of the entire set survive: the complete left door-seat with raised ledge around the hole where the doorpost fit and a notched right upper corner to fit around the lower left corner of a pavement slab; two-thirds of the threshold from the left side, but preserving the hole for the vertical bar of the armature of the closing mechanism (The front, lower edge of the threshold has a stepped edge.); and, a fragment of the lower left part of the right door seat including the corner and part of the raised margin around the doorpost hole.

The extant fragments were all inscribed, but much of the inscription on each piece was effaced because of erosion and weathering. The inscriptions read from the room B side of the doorway, that is, if one stood *in* the doorway facing room B, the cuneiform signs would be upside down. In the case of the doorpost seats, the inscriptions read across the holes, but no signs are missing. (See the inscriptions that pass over the holes for horizontal armature bars cut into standing slabs in entranceways; for example, Room S, door *a*.) The left doorpost seat preserves portions of the first lines of an abbreviated Standard Inscription, expanded titulary or other display text. The threshold seems to continue with a fragment of an historical text, from annalistic paragraphs which may accompany the standard titulary perhaps from the 5th Campaign (Year 4). The right seat is too effaced to read. We have no information whether or not the reverses of these stones were also inscribed as were the ones attributed to door *e*, courtyard WT.

The inscriptions read (facing the entrance from room B):

Left seat:

1. É. GAL *Aššur*-PAP.A {} SANGA *Aššur* [..]
2. u MAŠ *na-ra-am* {} [..]
3. *ka-šu-uš* DINGIR(MEŠ) {} GAL(MEŠ) MAN [..]
4. MAN ŠÚ MAN ^{kur}*Aššur* A TUKUL.MAŠ {} MAN GAL-[..]
5. MAN ŠÚ MAN ^{kur}*Aššur* A 10-ÉRIN.DAḪ {} MAN ŠÚ MAN [..]
6. [..] *šá ina* GIŠ TUKUL-*tí Aššur* {} EN-šú DU. [DU-*ku-ma*]

7. [..] *šá kib-rat* {} LIMMU-*ta* [..]
8. *la-a* TUK-ú ^{bi}SIPA *tab-ra-a-* {} [..]
9. *e-du-ú gap-šú šá ma-ḫi-ra* [..]-u MAN *mu*-[..]
10. [..]-*ḫar kiš-šat* ÛKU(MEŠ) *i*-[..]
11. *da-a-iš kul-lat* KUR(MEŠ) *mu-pa*-[..]
12. DINGIR(MEŠ) GAL(MEŠ) EN(MEŠ)-šú DU.DU-[..]
13. KUR-*ud ḫur-šá-ni* DÛ-šú-*nu i*-[..]
14. [..] (There is room for about 18 signs on this line which would end: UGU DÛ-šú-*na* KUR.KUR-(MEŠ).

Threshold:

1. [..] TUKUL(MEŠ) [[[]]] [..] šú ...šá DÛ-šú-*nu ina mal?* [..]
2. [..]-*i ana* ^{kur}*Za-mu-a* [[[]]] *šá ur?* *ni?*
3. *x-x-na-a-a x-x-ti x-a-a*
4. [..] *za?-na-a-a am?-ḫur?*
5. Remainder completely effaced.

Right seat: Surface completely effaced.

Bibliography: Sobolewski, *Palast u. Hütte*, figs. 3–5. The inscription is partly reconstructed from photographs, and notes made by J. Meuszynski at Nimrūd, and read with the help of John M. Russell.

(B)E-e-1 (L ~5.20 m; W ~0.80 m; H₁ ~4.75 m; H₂ ~5.00 m) Pl. 2.1; 4.1; 4.3

The companion, gigantic bull colossus (→). See above, ED-e-2.

Bibliography: See the discussion above and ED-e-2.

ED-5 (W ~1.30 m; H ~4.75 m) Pl. 4.3

Two- or three-registered relief with small genies (→) and perhaps a Standard Inscription.

Bibliography: See the discussion of ED-6 and the reconstruction discussed above, pp. 17 ff. and 20 ff.

ED-4 (W ~2.40 m; H ~4.50 m)

4-winged genie. Prototype: E-5 and D-1. (←).

Bibliography: See the discussion of ED-7, E-5 and D-1, s.v. and the reconstruction discussed above, pp. 17 ff. and 20 ff.

ED-3 (L ~4.94 m; W ~0.85 m; H₁ ~4.50 m; H₂ ~4.80 m) Pl. 3.1; 4.1

Gigantic lion-colossus (→). Prototype from room B, door *a* and courtyard Y, door *b* (room G). The figure had a three-horned helmet. See above, ED-8.

Bibliography: See below, room B and courtyard Y discussions.

ED-2 (W ~2.12 m; H ~4.50 m) Pl. 3.1; 4.1

4-winged, human-headed genie wearing a diadem or "garland" (→). For the type, see the reconstruction discussed above, s.v. ED-9.

Bibliography: See above ED-9.

The description and discussion continue now with *in situ* reliefs.

ED-1 (L 4.94 m; W 0.85 m; H₁ 4.50 m; H₂ 4.80 m)

Pl. 3.1; 4.1; 4.2

Restored *in situ* (Fig. 6.5). A complete figure of a winged bull-colossus of a special type (see above ED-10) with four attributes: human, bird, bull and fish. Its three-horned helmet has a "fish hood", its ears are fish-fin shaped, and its belly is carved with a decoration which depicts the finned and scaled body of a fish⁵⁹. For the parallel of the human figures dressed in "fish cloaks", see above, n. 42.

The inscription is carved as follows along the side of the figure⁶⁰:

Between the front legs: É.GAL . . to . . *mu-šak-niš la kan-šu-te-šú* (line 4)

Between the middle legs: *ša nap-ḥar kiš-šat* . . to . . *ina KUR.KUR(MEŠ) ša a-pe-lu-ši-na-ni* (line 16)

Between the rear legs: LÚ GAR-*nu-te-ia* (badly eroded) . . to . . *a-na^{kur} Lab-na-na lu-ú a-lik*. (line 26)

There does not seem to have been a continuation of the inscription behind the figure, but it is possible that it has eroded away. More of the inscription is preserved on ED-10, suggesting that there is room for more inscription on this stone.

Bibliography: Layard, *Nin.* I, p. 124; Mallowan, *Nim.* fig. 50; Weidner, *AfO* 15, pp. 143-4, fig. 4; Reade, *Iraq* 27, p. 131; Ainachi, *Sumer* 12, figs. 4, 5, 7, 9, pp. 127ff.; Shukri, *Sumer* 12, figs. 2, 3, 6; Meuszyński, *Reliefdarstellungen* I, pl. 6.2; Ameen Agha — al Iraqī, *Nimrūd*, fig. 9; Amiet, *Near East*, fig. 912; Orthmann, *Der Alte Orient*, fig. 175 (p. 297); Madhloom, *Chronology*, pl. LXXI,1 (drawing).

So-called Court E

E-5 (W 2.30 m; H 1.98 m — preserved; H 4.50 m — reconstructed) Pl. 4.2

A-II-a-i-35. The lower half of a colossal 4-winged genie carrying a bucket and a cone, facing right (→) (Fig. 5). The restoration of the figure is based upon the nearly complete restoration of the relief in position D-1; see above, s.v. The helmet had an open, flower-shaped spike on the top. This spike is found on helmets of the genies in room B, including those adjacent to the other side of this doorway⁶⁰. Except for the size, the genie is conventional in all other ways.

Middle band. The Standard Inscription runs across the lower part of the figure, over wings and garment, and is carved in 22 + 1 lines, ending: *ina lib-bi ú-kín*.

Bibliography: Layard, *Nin.* I, pp. 134-5, 385; Gadd, p. 199; Weidner, *AfO* 15, p. 143, fig. 4; Ravn, *AfO* 16, p. 235 (note 7); Stearns, *AfO-Beih.* 15, p. 74; Mallowan, *ILN* 5806, pp. 180ff., fig. 1; Shukri, *Sumer* 12, fig. 3; Ainachi, *Sumer* 12, fig. 4; Reade, *Iraq*, 27, p. 131; Meuszyński, *EiTrav* VI, p. 30, figs. 2a and 2b; Meuszyński, *EiTrav* IX, p. 10; Meuszyński, *Reliefdarstellungen* I, p. 32,34.

E-4 (W 1.96 m; H 0.63 m — *in situ*)

Pl. 4.1

In situ is the lower third of a relief depicting two tributaries facing left (←). The left figure wears boots with turned-up toes and stepped decorations on the heels. The one on the right wears conventional sandals (Figs. 4.5).

The upper part of the relief is preserved on a large fragment in the Iraq Museum, Baghdad (IM 28143), that is about one-half of the total width of the slab, if one includes the part that was covered by the edge of the slab with which it made the corner; see above E-5. The present drawing, based upon Layard's, has been checked with what is preserved.

Both figures are dressed in the same heavy robes, headbands, bracelets and counterweighted, beaded necklaces that their companions on adjacent slabs wear. On this slab, the left figure raises his closed hands in a sign of obeisance. The figure on the right carries a bucket in his lowered, right hand and a tray filled with either enlarged earrings or necklaces. These are essentially the same figures, except for the offerings carried by the one on the right, that are shown on E-1, see below.

Baghdad IM 28143 (W 1.01 m; H 0.91 m)

Middle band: The Standard Inscription was 18 lines long. The last 17-20 signs from each line are missing from the Baghdad fragment. This was an abbreviated inscription, ending: ŠU-su KUR-ud⁶¹.

Bibliography: Layard, *Nin.* I, p. 312; Layard, *Mon.* I, pl. 49; Weidner, *AfO* 15, pp. 143f., fig. 4,7; Mallowan, *Nim.* I, fig. 50; Meuszyński, *EiTrav* XI, p. 10, fig. 9; Meuszyński, *Reliefdarstellungen* I, pp. 32, 34, pl. 6.2.

E-3 (W 0.72 *in situ*, of which 0.17 m is inserted behind the right shoulder of E-c-2; H 0.92 m-preserved) Pl. 4.1

The lower third of a relief depicting a tributary facing left (←). The figure wears the same footwear as those on E-2 and on the right side of E-1, that is with turned-up toes and stepped decoration on the heels. This is the fragment *in situ* (Fig. 4).

The upper part of the relief is in Berlin (VA 8747) and depicts the same type of figure, dressed in the same garments and jewellery (seen here open in front because of the

⁵⁹ Thus we have symbolized in a single figure (denizens of) earth, air, water and humanity, the context of the totality of human experience on earth — a concept perhaps not consciously acknowledged in a complete way by Ashurnasirpal's scribes, who described the figures decorating the gate as mountain and sea beasts of white limestone and alabaster (Paley, *KW*, p. 132, section VIII B). Ashurnasirpal, who is enthroned beyond these doors is, after all, the *šar kiššati*, the king of the world. His palace is protected, therefore, by composite figures which symbolize the parts of the world which he claimed to rule. The king protects and the world protects, a two-way "deal": the opposite of "fighting fire with fire".

⁶⁰ Meuszyński, *Reliefdarstellungen* I, plate 1 and 2.

⁶¹ Paley, *KW*, p. 127, para. G (line 5).

direction in which this figure is portrayed) and wearing the same headband, as the one on E-2.

The hands are held closed and raised. He is bent in a deferring pose and is as small as the figure on E-2; see below. The slab fits behind the shoulder of the lion-colossus to the left.

The surface of the upper part of the Berlin fragment is eroded, and the left edge is broken off at the point at which it would have been inserted behind the shoulder of the colossus. The inscription, however, which would have been completely visible, preserves the first sign in each line as far as line 14.

Berlin VA 8747 (W 1.12 m; H 0.71 m)

Middle band. Except for the eroded and broken signs, this Standard Inscription is continuous from line 1 (É.GAL etc. . . to . . KUR.KUR(MEŠ) DÛ-ši-na (Var B) to the end of line 13. Lines 14 and 15 are poorly preserved as follows:

14. ŠU-su KUR-ud hur-ša-ni DÛ-šú-n[u . . .

i-pe-l]u-ma

15. bi-la[*t*-su-nu im-hu-ru sa-bi]t li-i-[i šá-kin⁶²

16. . . .

If the inscription was ca. 18 lines long (allowing for going beyond the 18 spaces lineated) as were the ones from court D, the text would have ended: *a-na i-da-at EN-ti-a lu-ú it-mu⁶³*, that is, as a known shortened version of the SI for narrow slabs.

Bibliography: Layard, *Nin.* I, p. 312; Layard, *Mon.* I, pl. 49; Gadd, p. 213; Weidner, *Afo* 12, p. 378 (p. 213); Weidner, *Afo* 15, pp. 143-4, fig. 6; Meyer, *Altorientalische Denkmäler*, pp. 152-153, fig. 67; Reade, *Iraq* 27, p. 131; Meuszyński, *EiTrav* VIII, pp. 57-8, fig. 22; Meuszyński, *EiTrav* XI, p. 10, fig. 3; Meuszyński, *Reliefdarstellungen* I, p. 34, pl. 6.2.

(B)E-c-2 (L 3.62 m; W 0.78 m; H₁ ~3.10 m; H₂ ~3.30 m)
Pl. 1.2; 4.1; 4.2

Winged lion-colossus with human upper torso and head (Fig. 4.5). The figure wears a full Assyrian beard and long hair which falls neatly on its shoulders, a two-horned helmet, a tight-fitting shirt, and a wide belt which disappears behind the wing feathers. It folds its right hand into its left hand in the manner of Assyrian royal officials facing left on reliefs (←). There is damage to the face, helmet, hands and left arm. The human body seems too small for the massive, powerful, leonine body to which it has been grafted. In the tradition of door figures of this type in this palace, there are five legs. Also, it is tethered. There is no indication of sex, which raises the question of whether this is a lion or lioness, despite the bearded countenance.

The inscription is carved along the side of the figure between the legs and behind, as follows:

Behind the figure: The beginning of the inscription is eroded away until some point in line 2. The following signs are readable: [. . .] Aššur [. . .] kib-rat [. . . šá-ni]n-šú [la-a TU]K-ú⁶⁴SIPA [tab-r]a-a-te la a-di-ru [GI]Š.LAL [. . .] e-du-ú gap-šú šá ma-ši-ra [la-a TUK-ú MAN mu-šak-niš [la] kan-šu-te-šú . . to . . el-la-an^{kur}Zaban TA

^{uru}DU₆ šá Ab-ta-ni a-di URU DU₆ šá Za-ab-da-a-ni (lines 14-15 – note reversed order of the placenames)

Between the rear legs: ^{uru}Hi-ri-mu . . to . . URU.URU u hur-ša-ni (line 17)

Between the middle legs: paṭ gim-ri-šú-nu . . to . . pa-a 1-en ú-šá-aš-kin (line 21). The text then skips to line 52: ^{uru}Kal-hu mah-ra-a šá^{md}SILIM-ma-nu-SAG MAN^{kur}Aš-šur NUN a-lik pa-ni-a DÛ-uš URU šu-ú e-na-aḥ!-ma! iṣ-lal URU šu-ú ana eš-šu-te ab-ni ÛKU(MEŠ) ki-šit-ti ŠU-ia šá KUR.KUR(MEŠ) šá a-pe-lu-ši-na-ni šá^{kur} Su-ḥi^{kur}La-qi-e ana si-ḥir-ti-šá^{uru}Sir-qu šá ni-bir-ti^{id}A-rat (line 54)

Between the front legs: ^{kur}Za-mu-a paṭ gim-ri-šá^{kur}É A-di-ni u^{kur}Ḥat-te u šá Lu-bar-na^{kur}Pa-ti-na-a-a al-qa-a ina lib-bi u-šá-aš-bit DU₆ la-be-ru lu ú-na-ki-ir a-di UGU A(MEŠ) lu ú-šá-pil (line 56)

Bibliography: Layard, *Nin.* I, pp. 124, 310, 312; Layard, *Mon.* I, pl. 42 right; Weidner, *Afo* 15, pp. 143 f., figs. 4, 5; Mallowan, *Nim.* I, fig. 50; Shukri, *Sumer* 12, fig. 6; Ainachi, *Sumer* 12, figs. 4-5, 8-9; Meuszyński, *EiTrav* XI, p. 10; Ameen Agha – al Iraqi, *Nimrud*, fig. 9; Madhloom, *Chronology*, pl. LXXI, fig. 3 (a drawing); Meuszyński, *Reliefdarstellungen* I, pp. 32, 34.

(B)E-c-4 (W 1.11 m)

Slab carved only with a band of the Standard Inscription against which the right door leaf could be swung when left in an open position. Only the socle is preserved *in situ*. No other information is available.

Door seats and threshold.

No threshold or seats for doorposts are now *in situ*. The doorseats may have already been missing in Layard's time. The threshold inscription was published by Layard in *ICC*. It contained a portion of an abbreviated annalistic inscription from the sixth campaign (Year 5) beginning ^{uru}Ku-ú-ku-nu and ending ŠE.KIN.TAR^{kur}-šú-nu e-ši-di ŠE.AM(MEŠ). The text starts in the upper left corner of the stone. The slot for the closure mechanism, indicated in Layard's copy, does not destroy any cuneiform signs. There are 19 lines of text, suggesting a deeper threshold than in door *e*. The text was read from inside room B.

Bibliography: Layard, *ICC*, pl. 84; Le Gac, *Estampages*, pp. XVf and E 72 a-b; Paley, *KW*, p. 155, item 33; Russell, *Inscriptions (Manuscript), and conversations*.

Pavement in the doorway (L 3.70 m; W 1.82 m)

A single pavement slab with inscription. Layard was able to copy a significant portion of the annals text on this slab. Today the slab is almost totally effaced. A number of signs can still be identified on the left hand side of the stone, next to E-c-1. The inscription records abbreviated titles for Ashurnasirpal, his father and grandfather and an excerpt from the text of the sixth campaign ending with: *ma-da-tu šá*

⁶² Paley, *KW*, p. 127, para. G (line 5).

⁶³ Paley, *KW*, p. 127, para. I (line 6).

^{kur}[Ni-ir-du-un ANŠE-KUR.RA] (MEŠ). There are about ten lines missing from the text which starts at the beginning of the campaign and ends at the *Tuša* episode.

Bibliography: Layard, *ICC*, plates 48–49, 84; King, *AKA*, p. 326, line 86 to p. 340, line 117; Paley, *KW*, p. 155 (item 33).

(B)E-c-3 (W 1.15 m; H ~0.50 m)

Slab carved only with a band of the Standard Inscription against which the left door leaf could be swung when the doors were open. The slab is broken just below where the inscription should end. No other information about this slab is available.

(B)E-c-1 (L 3.62 m; W 0.76 m; H₁ 3.10 m; H₂ 3.30 m)
Pl. 1.2; 4.1

The companion figure to E-c-2 and like it in all details except reversed (Figs. 3;5). The hands are folded left into right in the manner of right-facing Assyrian royal officials (→). There is significant damage to the face, helmet and to the hands.

The inscription is carved along the side of the figure on all flat surfaces, between the legs and behind it, as follows:

Between the front legs: É.GAL .. to ..
10-ERÍN-DAḪ (line 2)

Between the middle legs: MAN GAL-*e* MAN *dan-ni*
MAN ŠÚ MAN ^{kur}Aššur-ma .. to .. KUR.KUR(MEŠ)
e-nu-ma Aššur EN *na-bu-ú* (line 8)

Between the rear legs: MU-*ia* .. to .. *aš-gu-um* MAN
šá e-bir-tan (line 11)

Behind the figure: [eroded ^ḫHAL.ḪAL/IDIGNA?
...] GAL-*t[e* ...] *ana si-ḫír-ti-š[á]* ^{kur}*Suḫi a-d[í]*
^{uru}*Ra-pi-q[í]* .. to .. *ḫa-si-su pe-et uz-ni né-me-qi* ^{dÉ}-*a*
(line 23)

Bibliography: Layard, *Nin.* I, pp. 124, 310, 312; Layard, *Mon.* I, pl. 42; *Or.Dr.* III, N.W. IV; Mallowan, *Nim.* I, fig. 50; Shukri, *Sumer* 12, fig. 6; Ainachi, *Sumer* 12, figs. 4–5, 8–9; Meuszyński, *EtTrav* XI, p. 10; Ameen Agha – al Iraqi, *Nimrud*, fig. 9; Meuszyński, *Reliefdarstellungen* I, p. 32.

E-2 (W 0.72 m – *in situ*; 0.18 m inserted behind the shoulder of the door colossus; H 1.00 m – preserved)
Pl. 4.1

The lower third of a relief depicting one figure facing right (→). He wears the same footwear as the figure on the right of E-1, for example, with turned-up toes and stepped decoration on the heels. Figs. 3.5.

The upper part of the relief is missing but was recorded by Layard. The drawing shows a proportionately smaller version of the figure on the right of E-1 and on E-4 (see above). The slab fits behind the shoulder of the lion-colossus to the right.

Middle band: No inscription is preserved.

Bibliography: Layard, *Nin.* I, pp. 124, 312; *Or.Dr.* III, N.W. XXXVI; Mallowan, *ILN* 5805, p. 149f.; Shukri, *Sumer* 12, fig. 6; Ainachi, *Sumer* 12, fig. 5; Ameen Agha – al Iraqi, *Nimrud*, fig. 9; Meuszyński, *EtTrav* XI, p. 10, fig. 7; Meuszyński, *Reliefdarstellungen* I, p. 34.

E-1 (W 2.17 m; H. 0.72 m – preserved) Pl. 4.1

The lower third of a relief depicting two figures facing right (→). The one on the right wears boots with turned-up toes and a stepped decoration on the heels as do other figures on this façade. The one on the right wears conventional sandals. Figs. 3.5.

The upper part of the relief was lost, but it was recorded by Layard when it was found. The drawing shows that the figure on the right was a full-bearded male wearing a fringed robe, bracelets, and a counterweighted string of beads around his neck. A diadem, wider in front than in the back, holds his hair in place. He raises both his arms before him, hands closed, as a sign of obeisance. His companion behind him wears a similar robe, necklace, bracelets and diadem, but holds gifts: a flask in his lowered right hand and a tray filled with earrings, bracelets and a necklace is raised in his left.

As a further signal of their approach to their sovereign, both figures bend forward slightly in deference.

Middle band: No inscription is preserved.

Bibliography: Layard, *Nin.* I, pp. 124, 312; *Or.Dr.* III, N.W. XXXVI; Mallowan, *ILN* 5805, pp. 149ff.; Shukri, *Sumer* 12, fig. 6; Ainachi, *Sumer* 12, fig. 5; Ameen Agha – al Iraqi, *Nimrud*, fig. 9; Meuszyński, *EtTrav* XI, p. 10, fig. 6; Meuszyński, *Reliefdarstellungen* I, p. 34.

The balanced composition of pairs of human figures – gift or tax bearers on the outside and others doing obeisance on the inside – and the two lion-colossi in the doorway, their human aspect cast in an attitude of attending courtiers and essentially replacing such officials in this scene⁶⁴, has been enhanced by the artist's clever reduction of the size of the two closest to the doorway. This compositional scheme provides a sense of perspective rarely so evident in Assyrian art⁶⁵.

The king's presence on relief is not required here (compare court D, above) since his majesty was seated on his throne just beyond the doorway⁶⁶. The composition also acts as a decorative signature pointing to the throne's location. The front of the thronebase and the busy courtiers were visible when the doors of this entranceway were thrown open and the king was present in his official capa-

⁶⁴ There is the additional possibility that some of the tribute bearers are Assyrians bearing the spoils of war and the courtyard scenes depict part of what the inscriptions, including those on the door colossi, say about what went on when the city was built and became the center of the king's life. Assyrians and non-Assyrians should be participating in homage to the ruler.

⁶⁵ See on this subject, Albenda, *JNES* 31, pp. 168ff.

⁶⁶ Russell, *Bull* (Manuscript), p. 5 with footnotes 28a and 29.

city. Thus the combination of human and animal figures in the relief and the activity around the throne complete the picture of the king's majesty⁶⁷.

The space designated as EA by the British Excavations in the 1950's, which is east of the area just now described, did not have stone dado when excavated. It is not known whether it ever did. A yellow sandstone stele of Ashurnasirpal II, inscribed with a text summarizing his conquests and describing his new capital and the feastday commemorating its completion, was found in the center of this space. At a later period, the mudbrick walls were strengthened with a mudbrick buttress and a new pavement was laid⁶⁸.

⁶⁷ Mallowan once wrote that this was the exit from the throneroom used by those granted a royal audience, and he is probably correct: Mallowan, *Nim.* I, pp. 103 ff. Could the fact that the lion colossi in court D hold offerings and those in court E not, have anything to do with the pattern of movement and activity in the Northern Courtyard? Could the offering-bearer genies and *lamassu* be a "suggestion"? – Enter here, bring gifts, tribute! Leave by that door (emptyhanded but reverent)!? – this despite the fact that some of the figures adjacent to the doorway in court E do hold offerings as a recurrent reminder of continuing responsibility for tribute.

⁶⁸ See above, note 4.

II. Room B

1. ENTRANCES

A. PRESENT CONDITION

Originally discovered by Layard, this room was re-excavated by M.E.L. Mallowan¹ and Behnam Abu es-Soof. Abu es-Soof finished clearing the room and extending the work to include room C, the stairwell beyond it, the passageway WZ connecting courtyard WT and the Northwest Wing of the palace, and the preserved portions of two of three adjacent rooms to its west at the present-day edge of the mound. Abu es-Soof also had the walls of all these rooms restored in stone and cement and reassembled the fragments of relief in their proper positions². At some point, the "yellow" limestone bulls were removed to the Iraq Museum in Baghdad from the doorway B-b leading to room F. There are no extant door figures facing towards room B remaining *in situ*.*

The positions of the doorways and the widths of the walls could be established from the remains of the mudbrick, the bases of the reliefs removed by Layard and others and now in the British and other museums, and paving on the floors. This must have been particularly difficult in the area of entrance B-a since Layard's description of the removal of the lion-*lamassu* which were shipped to the British Museum, explains that the adjacent mudbrick walls were dismantled down to the artificial platform upon which the palace was built.

This room has been discussed by Mallowan and Meuszyński³. (See Plan 1).

Completely preserved socle of a wall relief: B-b-4 (Standard Inscription only).

Partly preserved socle of a wall relief: B-b-3 (Standard Inscription only).

No preserved socles: B-a-1 and B-a-2 (Human-headed lion *lamassu*, → and ←); B-b-1 and B-b-2 (Human-headed bull *lamassu*, → and ←).

B. ACCORDING TO LAYARD

Entrance b, Chamber B

"As there was a ravine running far into the mound, apparently formed by winter rains, I determined to open a trench in the centre of it. In two days the workmen reached the

top of a slab, which appeared to be both well preserved, and to be still left standing in its original position. On the south side I discovered, to my great satisfaction, two human figures, considerably above the natural size, sculptured in low relief, and still exhibiting all the freshness of recent work. This was chamber B in the third plan... The ornaments delicately graven on the robes, the tassels and fringes, the bracelets and armlets, the elaborate curls of the hair and beard, were all entire. The figures were turned back to back, and furnished with wings. They appeared to represent divinities, presiding over the seasons, or over particular religious ceremonies. The one, whose face was turned to the East, carried a fallow deer on his right arm, and in his left hand a branch bearing five flowers. Around his temple was a fillet, adorned in front with a rosette. The other held a square vessel, or basket, in the left hand, and an object resembling a fir cone in the right. On his head he wore a rounded cap at the base of which was a horn. The garments of both, consisting of a stole falling from the shoulders to the ankles, and a short tunic underneath, descending to the knee, were richly and tastefully decorated with embroideries and fringes, whilst the hair and beard were arranged with study and art. Although the relief was lower, yet the outline was perhaps more careful, and true, than that of the Assyrian sculptures of Khorsabad. The limbs were delineated with peculiar accuracy, and the muscles and bones faithfully, though somewhat too strongly, marked. An inscription ran across the sculpture.

To the west of this slab, and fitting to it, was a corner-stone ornamented with flowers and scroll-work, tastefully arranged, and resembling in detail those graven on the injured tablet, near entrance *d* of the S.W. Building. I recognized at once from whence many of the sculptures, employed in the construction of that edifice, had been brought; and it was evident that I had at length discovered the earliest palace of Nimroud."

"The cornerstone led me to a figure of singular form [No. 32, chamber B, plan 3]. A human body, clothed in

* see Reliefdarstellungen I, Plan 2.

¹ Mallowan, *Iraq* 14, pp. 10–11.

² Abu es-Soof, *Sumer* 19, pp. 66–68, plates I, II.

³ Meuszyński, *Reliefdarstellungen* I, pp. 17–25, plates 1–3 (see esp. entrances a and b, p. 25). Meuszyński, *ZA* 64.

robes similar to those of the winged men on the previous slab, was surmounted by the head of an eagle or of a vulture [It has been suggested that this is the head of a cock, but it is unquestionably that of a carnivorous bird of the eagle tribe.]. The curved beak, of considerable length, was half open, and displayed a narrow pointed tongue, which was still covered with red paint. On the shoulders fell the usual curled and bushy hair of the Assyrian images, and a comb of feathers rose on the top of the head. Two wings sprang from the back, and in either hand was the square vessel and fir cone."

(*Nin.* I, pp. 70–2)

"They had uncovered the upper part of the figure, the remainder of which was still buried in the earth. I saw at once that the head must belong to a winged lion or bull, similar to those at Khorsabad and Persepolis. It was in admirable preservation. The expression was calm, yet majestic, and the outline of the features showed a freedom and knowledge of art, scarcely to be looked for in the works of so remote a period. The cap had three horns and, unlike that of the human-headed bulls hitherto found in Assyria, was rounded and without ornament at the top. . .

I now ordered a trench to be dug due south from the head, in the expectation of finding a corresponding figure, and before night-fall reached the object of my search about twelve feet distant."

(*Nin.* I, pp. 72–3)

"It was remarkable that whilst such parts of the chamber B as had been uncovered were paved with kiln-burnt bricks, and the entrance *d* with a large slab of alabaster, between the two great lions there was only a flooring of common sun-dried brick. In the middle of the entrance, near the forepart of the lions, were a few square stones carefully placed. I expected to find under them small figures in clay, similar to those discovered by M. Botta in the doorways at Khorsabad, but nothing of the kind existed."

(*Nin.* I, p. 111)

"In chamber B the wall was continued to the south, or to the left facing the great lion [entrance a, Chamber B, plan 3], by an eagle-headed figure resembling that already described; adjoining it was a cornerstone, occupied by the sacred tree; beyond, the wall ceased altogether. On digging downwards, it was found that the slabs had fallen in; and although they were broken, the sculptures, representing battles, sieges, and other historical subjects, were, as far as it could be ascertained by the examination of one or two, in admirable preservation. The sun-dried brick wall, against which they were placed, was still distinctly visible to the height of twelve or fourteen feet; and I could trace, by the accumulation of ashes, the places where beams had been inserted to support the roof, or for other purposes."

(*Nin.* I, pp. 118–9)

Appendix:

"Entrance a. 1 and 2, winged human-headed lions, facing chamber B.

No. 1. Eagle-headed, winged, human figure, bearing square vessel and fir cone.

No. 2. Corner stone with sacred tree.

No. 32. Eagle-headed, winged, human figure, similar to No. 1."

(*Nin.* I, pp. 308, 311)

"The gigantic human-headed lions, first discovered in the north-west palace at Nimroud [*Nineveh and its Remains*. vol. I, p. 65 (72ff.)] were still standing in their original position. Having been carefully covered up with earth previous to my departure in 1848, they had been preserved from exposure to the effects of the weather, and to wanton injury on the part of the Arabs. The Trustees of the British Museum wishing to add these fine sculptures to the national collection I was directed to remove them entire. A road through the ruins, for their transport to the edge of the mound, was in the first place necessary, and it was commenced early in December. They would thus be ready for embarkation as soon as the waters of the river were sufficiently high to bear a raft so heavily laden, over the rapids and shallows between Nimroud and Baghdad. This road was dug to the level of the pavement or artificial platform, and was not finished till the end of February, as a large mass of earth and rubbish had to be taken away to the depth of fifteen or twenty feet. During the progress of the work we found some carved fragments of ivory similar to those already placed in the British Museum; and two massive sockets in bronze, in which turned the hinges of a gate of the palace. No remains of the door-posts, or other part of the gate were discovered in the ruins, and it is uncertain whether these rings were fixed in stone or wood [The sockets, which are now in the British Museum, weigh 6 lb. 3 3/4 oz.; the diameter of the ring is about five inches, The hinges and frames of the brass gates at Babylon were also of brass (Herod. 1. 178)]."

(*Nin. Bab.* pp. 162–163)

"By the 28th of January, the colossal lions forming the portal to the great hall in the north-west palace of Nimroud were ready to be dragged to the river-bank. The walls and their sculptured panelling had been removed from both sides of them, and they stood isolated in the midst of the ruins."

(*Nin. Bab.*, p. 201)

"Beneath the lions, embedded in earth and bitumen, were a few bones, which, on exposure to air, fell to dust before I could ascertain whether they were human or not. The sculptures rested simply upon the platform of sun-dried bricks without any other sub-structure, a mere layer of bitumen, about an inch thick, having been placed under the plinth."

(*Nin. Bab.*, p. 203)

Entrance b, Chamber B

"This wall (with historical subjects – see entrance a) served as my guide in digging onwards, as, to the distance of 100 feet, the slabs had all fallen in. . . .

The first sculpture, still standing in its original position, which was uncovered after following this wall, was a winged human-headed bull of yellow limestone. On the previous day the detached head, now in the British Museum, had been found. The bull, to which it belonged, had fallen against the opposite sculpture, and had been broken by the fall into several pieces. I lifted the body with difficulty; and, to my surprise, discovered under it sixteen copper lions, admirably designed, and forming a regular series, diminishing in size from the largest, which was above one foot in length, to the smallest, which scarcely exceeded an inch. To their backs was affixed a ring, giving them the appearance of weights. Here I also discovered a broken earthen vase, on which were represented two priapean human figures, with the wings and claws of a bird, the breast of a woman, and the tail of a scorpion, or some similar reptile. I carefully collected and packed the fragments. Beyond the winged bull the slabs were still entire, and occupied their original positions. On the first was sculptured a winged human figure, carrying a branch with five flowers in the raised right hand, and the usual square vessel in the left. Around his temples was a fillet adorned with three rosettes. On each of the four adjoining slabs were two bas-reliefs, separated by a band of inscriptions. . . ."

(*Nin.* I, pp. 119–120)

"As the edge of a deep ravine had now been reached by the trenches, the workmen were directed to return to the yellow bulls, which were found to form the entrance into a new chamber, marked F in the 3rd plan."

(*Nin.* I, p. 124)

Appendix:

"No. 15. Colossal winged figure facing entrance *b*, with garland round head, carrying a flower with five branches in one hand, and square vessel in the other.

Entrance *b*. 1 and 2, winged human-headed bulls in yellow limestone, facing chamber B. 3 and 4, slabs with standard inscription.

No. 16. Similar to 15; figure facing entrance *b*."

(*Nin.* I, p. 310)

C. ACCORDING TO MALLOWAN

"Excavations at the east end of this room exposed the great stone table with stepped top which had been discovered by Layard a century ago. This was leaning at an angle of about thirty-five degrees, presumably as he had left it, and has now been moved to the Mosul Museum. We cut away a broad section of the already ruined eastern wall in order to see if there was a foundation deposit embedded within it, as was the case in the Ishtar Temples at Ashur, but none were

discovered. In the south-eastern sector of the room, however, there were fallen frescoes, presumable from the upper parts of the walls. The painting was done directly on to a prepared mud plaster and included a large fragment of a chariot scene with horses' heads and an eight-spoked wheel. There was also a polygonal design in brilliant cobalt blue, red and white, which looked like the representation of a coffered ceiling. Beneath the frescoes lay a number of finely engraved fragments of ivories which were covered by a layer of 10 cm. of clay and rested directly on a hard beaten mud pavement overlaid with bitumen, apparently contemporary with the reign of Assur-nasir-pal. This pavement was flush with the bottom of the high plinth which had formed a base or edging to the wall-sculpture, and Layard, who had been mainly interested in cutting away the sculpture, had evidently not dug down to the floor level in this section. Inevitably therefore we are led to suspect that the centre of this great Hall may be worth digging again, and that only the soil immediately adjacent to the walls can have been thoroughly cleared."

(*Iraq* 14, pp. 10–11; see also *Iraq* 15, pp. 26–7.)

"In rooms F and B we dug out a small portion of the centre of the chambers, for we suspected that Layard had in fact only trenched along the wall facing in order to recover the sculpture and that he had left much of the middle portion of the chambers undug. This, in fact, proved to be the case: the floor was encumbered with a heavy belt of fallen mud-brick, which was the remains of the collapsed mud-brick wall and roof. Mixed with the mud-brick were many traces of painted frescoes at varying levels. Some would appear to have fallen from high up on the walls, other fragments possibly from the ceiling. Most striking was a portion of panel with a geometric design discovered in the middle of chamber B, a series of interlocking circles forming a kind of guilloche executed in a brilliant cobalt blue, red and black. This geometric band must have once been placed either high up on the room walls, or possibly on the ceiling."

(*Iraq* 15, pp. 26–7)

"Two bearded monsters which had guarded either side of the entrance connecting room F with room B were also partially re-excavated and found to be in good condition."

(*Iraq* 12, pp. 180–1)

D. COMPARATIVE ANALYSIS OF THE SOURCES

This room has been discussed many times, most recently by Meuszyński⁴ and Winter⁵. It is not the purpose of this discussion to repeat any of their conclusions. What must be emphasized, however, is that the doorways were designed as separate units, with the geniuses on adjacent wall slabs

⁴ Meuszyński, *loc. cit.*

⁵ Winter, "Royal Rhetoric"; Winter, "Program".

facing the *lamassu*, i. e. facing the entrances, whether or not the *lamassu* were facing room B or the Great Northern Courtyard. Attention to an entrance is paramount in this arrangement; the bas-relief between the entrances belong to other design conceptions and serve other purposes⁶. This includes also the room-B side of entrance (B)ED-e, and slabs 26g and 26h in our reconstruction, which may have had eagle-headed, winged figures depicted on them⁷.

E. RELIEFS IN COLLECTIONS OUTSIDE OF NIMRŪD

All four *lamassu* which faced room B have been removed from Nimrūd. Gadd listed and identified them:

B-a-1. BM 118801. Winged, human-headed lion, with five legs, facing (→).

B-a-2. BM 118802. Winged, human-headed lion, with five legs, facing (←).

(F)B-b-1. BM 118894 (human head) + IM 26472 (the rest of the figure). Winged, human-headed bull, with five legs, facing (→).

(F)B-b-2. IM 26473. Winged, human-headed bull, with five legs, facing (←).

F. IDENTIFICATIONS AND RECONSTRUCTIONS

Since the positioning and identifications of these door figures is relatively certain, the following discussion relates only to the relationship between the door compositions and the other sculpture in the room. At the same time, it is perhaps important to note that there is an internal imbalance resulting from the fact that the two doors that lead to the inner parts of the palace – B-a, leading to the West and Northwest Wings, and (F)B-b, leading to the south – have figures that face room B, but (E)B-c, (ED)B-e and (D)B-d face the Great Northern Courtyard. This imbalance has the effect of drawing one through room B, the throneroom, to the other state apartments of the palace for other ceremonies and to do other state business. Had there been figures facing room B in all doorways, the inclusiveness of the unit would have been communicated in the architecture and design of the room and no singular sign of passage to other rooms would have been indicated.

We estimate, based upon an average width of the slabs in other parts of the room, that there were four additional narrative slabs between entrances (B)ED-e and (B)D-d,

and five between (B)ED-e and (B)E-c. There is also the possibility that the slabs opposite entrance (F)B-b were arranged differently than we indicate on the plan and that a scene of the same type as B-13 and B-23 was portrayed there. This is pure speculation, but would be consistent with the idea that passage through a major entrance to the throneroom (B-b is the main entrance from the south) resulted in a confrontation with a symbolic representation of kingship.

We also assume that the artists would have used different ancillary, attending figures at each doorway, which is indeed the case: B-a (eagle-headed winged geniuses, carrying bucket and cone), B-b (human-headed, winged geniuses, wearing fillet, holding a branch up and a bucket down), B-c (human-headed, four-winged geniuses, wearing horned helmet, carrying mace in the lowered hand and raising up the other in a sign of greeting[!]), B-d (human-headed, winged geniuses, wearing fillet, carrying an animal offering in one hand and a raised branch in the other)⁸. Also, we might expect another type of human-headed genius or a pair of eagle-headed ones in positions 26g and 26h, alternating between two pairs of human-headed figures, and attending to the rears of the bull-*lamassu* of entrance (ED)B-e.

We have no information concerning the nature of the arches above the *lamassu* of entrances B-a and (F)B-b. We can only assume that they are similar to those of the other entrances in the room. The thickness of the walls that enclose room B, which point to the importance of the room, suggest that the walls were high, supporting either a second floor and/or a high ceiling with a clerestory lighting system. We think that the arches were similar in shape to those we propose for the main entrances to the throneroom from the Great Northern Courtyard. However, the doorway and arch of (F)B-b are smaller than the others: the *lamassu* from that doorway are ca. 0.75 m shorter in height and over 1 m shorter in length than those in (E)B-c, (D)B-d or B-a. These bulls maybe of a lower rank, since they are smaller and wear helmets with only one set of horns. See our remarks at the beginning of this section. Are these indications of a difference in this doorway from the others associated with this room?

⁶ See above chapter I and Winter, *loc. cit.*

⁷ See below, s.v. Identifications and Reconstructions.

⁸ Meuszyński, *Reliefdarstellungen* 1, plates 1 and 2.

2. CATALOGUE

Entrance B-a

B-1. For this figured slab see Meuszyński, *Reliefdarstellungen* I, p. 20, pl. 3.1.

B-a-2 (L 3.71 m; W 0.81 m; H₁ 3.08 m; H₂ 3.50 m)
Pl. 5.1

London, British Museum, BM 118802. Winged, human-headed lion, facing (←). The figure wears a three-horned helmet, earrings, and traditional Assyrian hair and beard style. It has a tie-cord around its midriff. It also has five legs. The inscription begins between the front legs and continues under the belly (between the middle legs), between the hind legs and behind the figure, as follows:

Between the front legs: É.GAL . . to . . *et-lu qar-du* (line 2)

Between the middle legs: *ša ina* ^ŠTUKUL-ti *Aššur* . . to . . ÉRIN.ĦI.A(MEŠ) ^{kur}*Lu-ul-lu-me-e* (line 9)

Between the rear legs: DAGAL(MEŠ) *ina qe-reb tam-ħa-ri* . . to . . TA ^{kur}*Né-reb* (line 13)

Behind the figure: *ša* ^{kur}*Kir-ru-ru* . . to . . u ^dNin-urta
AGA SANGA-ti-ia (in the middle of a sentence, line 26)

Bibliography: Layard, *Nin.* I, pp. 70 ff., 118 ff., 308; Layard, *Nin.* II, p. 74; Layard, *Nin. Bab.*, pp. 62, 162–163, 201–205; Bonomi, *Nineveh and its Palaces*, frontispiece; Gadd, pp. 125, 247; Barnett, *AssPal*, pl. 1; Stearns, *AfO-Beih.* 15, pp. 72 f.; Reade, *Iraq* 27, 130 f.; Meuszyński, *Reliefdarstellungen* I, p. 25, pl. 3.1.

When Layard discovered this doorway, he noted that there were bricks on the floor of the entranceway between the two *lamassu*. This was either an ancient repair – the stone pavement having been damaged or removed to be used elsewhere – or an indication that the throneroom and room C were somehow united⁹, the bricks being a continuation of the throneroom flooring, uninterrupted by a separating stone threshold or pavement.

B-a-1 (L 3.63 m; W 0.85 m; H₁ 3.08 m; H₂ 3.50 m)
Pl. 5.1

London, British Museum, BM 118801. Winged, human-headed lion facing (→). The figure wears a three-horned helmet, earrings and conventional Assyrian-style hair and beard. It has a tie cord around its midriff and five legs. The inscription begins behind the figure and continues between the rear legs, between the middle legs and between the front legs as follows:

Behind the figure: É.GAL . . to . . ^{kur}*U-ru-ar-ti ŠU-su*
KUR-ud (line 13)

Between the rear legs: *ša* ^{kur}*né-reb ša* ^{kur}*Kir-ru-ri* . . to . . *ur-du-ti ú-pu-uš* (line 17)

Between the middle legs: ^m*Aššur-PAP.A NUN-ú na-du* . . to . . *ħa-si-su pi-it uz-ni né-me-qi ša* (line 23)

Between the front legs: ^d*É-a* MAN ZU.AB . . to . . *ana*
^{kur}*Lab-na-na* (in the middle of a sentence, line 26)

Bibliography: Layard, *Nin.* I, opposite p. 70, pp. 70–73; 118–119, 308; Layard, *Nin.* II, p. 74; Layard, *Nin. Bab.*, pp. 62, 162–163, 201–205; Layard, *Mon.* I, pl. 3; *Or.Dr.* III N.W. I; Budge pl. IV; *Guide* (1922), pl. VII, Gadd, pp. 124–125, 247; Stearns, *AfO-Beih.* 15, pp. 72 ff.; Reade, *Iraq* 27, p. 130 f.; Barnett, *AssPal*, pl. 1; Meuszyński, *Reliefdarstellungen* I, pl. 25, pl. 3.1.

B-32. For this figure see Meuszyński, *Reliefdarstellungen* I, p. 25, pl. 3.1.

Entrance (F)B-b

B-16. For this figure see Meuszyński, *Reliefdarstellungen* I, p. 22, pl. 1.4.

(F)B-b-2 (L 2.59 m; W 0.49 m; H₁ 2.40 m; H₂ 2.79 m)
Pl. 5.2

Baghdad, Iraq Museum, IM 26473. Winged, human-headed bull-colossus, facing (←). The figure wears a full Assyrian beard and long hair which falls neatly on its shoulders. It wears a one-horned helmet. This is one of the pair of “yellow limestone bulls” described by Layard. Ashurnasirpal’s inscriptions state that he used “white limestone” for the carving of some of “the beasts of the mountains and the fields” and it is possible that this is the stone and the figures to which he referred, the limestone having aged to its presentday yellowish color. Examination of the top of the slab shows that there are slots for braces that anchored the slab in place – either to adjacent stones or to the superstructure. The wings stretch out above the back as if the animal is ready for flight as is the case with all these winged door figures. This time however, the wings (and tail) fill the whole space reaching the back edge of the stone and precluding the inclusion of as much inscription as we have on other examples. The signs are also very large compared to other inscriptions on *lamassu*. In fact, the inscription is carved only between the legs of this figure and ends not only in mid-sentence but also in the middle of a place-name, a classic case of misplanning the inscriptional space. There is not much text:

Between the front legs: É.GAL . . to . . *la* TUK-ú (line 3)

Between the middle legs: ^{lu}SIPA *tab-ra-a-te* . . to . . ÉRIN.ĦI.A(MEŠ)-at (line 9)

⁹ Winter has suggested that the depiction of the king on the western wall of room C, which could be seen from the throne through door B-a, was part of the artistic conception of the throneroom. “Royal Rhetoric” p. 10. The depiction is of the king with bowl and bow flanked by attendants: Meuszyński, *Reliefdarstellungen* I, p. 27, pl. 4.

Between the rear legs: ^{kur}*Lu-ul-lu-me-e* . . . to . . . ^{kur}*Zaban*
TA ^{ur}DU₆ (breaking in the middle of the place name *Til*
ša Zabdanī, line 13)

Bibliography: Layard, *Nin.* I pp. 119, 124, opposite p. 127; Layard, *Mon.* I, pl. 4; Gadd, 228–9, 247; Reade, *Iraq*, 27, p. 131f.; Meuszyński, *Reliefdarstellungen* I, p. 25, pl. 4.1; *Oasis and Steppe Routes*, no. 6, pp. 35–37¹⁰.

(F)B-b-3 (W 1.33 m – preserved, ca. 2.45 originally)

Fragment of a socle of a slab which originally had only the Standard Inscription carved on it. See Meuszyński, *Reliefdarstellungen* I, p. 25.

We have no information concerning whether or not there was a paving stone in the entranceway.

(F)B-b-4 (W 2.43 m)

Socle of a slab which originally had only the Standard Inscription carved on it. See Meuszyński, *Reliefdarstellungen* I, p. 25.

(F)B-b-1 (L 2.56 m; W 0.55 m; H₁ 2.45 m; H₂ 2.20 + ca. 0.59 m) Pl. 5.2

Baghdad, Iraq Museum, IM 26472 (the body) and London, British Museum, BM 118894 (the head). Winged, human-headed bull colossus, facing (→). This is the second of the pair of “yellow limestone bulls” described by Layard and is like the first in every regard except for the fact that it faces in the opposite direction. There is a piece of the slab mis-

sing from the upper left corner. Examination of the top of the slab shows that there are slots for anchoring the slab in place – either to adjacent stones or to the superstructure. The bull also fills the space on the slab so that there is no room for much inscription behind the figure. So, like its pair, it is not inscribed there. The cuneiform signs are also very large which means that there is not much text. There are no published photographs from which we can determine the placement of the inscription between the legs of the figure. The inscription ends with the phrase: *a-di* ^{kur}*Gilza-ni* (line 12). The figure is also inscribed on the reverse with a short version of a Standard Inscription¹¹.

Bibliography: Layard, *Nin.* I, p. 119–120, opp. 127, 124, 127–8, 139–41, 310; Layard, *Nin.* II, 315, *Or. Dr.* III, N.W. 2; Schaeffer – Andrae, pl. XXX; Gadd, 228–9, 127–8, pl. 2; Amiet, *Art*, pp. 405, 454, fig. 595; Meuszyński, *Reliefdarstellungen* I, p. 25, pl. 4.1¹².

(Photographs of this bull show the head restored in plaster.)

B-15. For this figure, see Meuszyński, *Reliefdarstellungen* I, p. 22, pl. 2.1.

¹⁰ Our thanks to Nicholas Postgate for measuring the bulls and for the information about the slotting, and to John M. Russell for the reference to *Oases and Steppe Routes*.

¹¹ We owe the information about the inscription on the reverse to John M. Russell.

¹² See above n. 10.

III. Courtyard Y

1. WALLS AND ENTRANCES

A. PRESENT CONDITION

After excavating this courtyard, the Iraqi State Organization of Antiquities restored the walls and reerected the fallen slabs which had collapsed on the floors. The clearance of the courtyard revealed the terracotta pavement (in two layers) as well as a large number of the square stone slabs with round openings in their centers. The stone slabs form some kind of the system, mainly near the entrances leading to the neighbouring rooms, but also in the open area of the courtyard. Some of these slabs, situated in the center of the courtyard led to a trough for rain water. (Plan 2.)

Mallowan's excavations in the southeast corner of the courtyard at corridor P had revealed two phases of repair work subsequent to Ashur-nasir-pal's original floor: the first was dated to the reign of Shalmaneser III, the second to that of Sargon II (See below). Only one phase beyond the original floor could be clearly distinguished in the courtyard proper in the Iraqi excavation. The pavement is partly destroyed in the southwest part of the space, in the center, and wherever wall slabs and doorway figures had been removed by ancient builders or by modern archaeologists*. In the areas where the pavement is not preserved, one can see the mudbricks of the deck upon which the whole palace complex was built¹.

Only one set of poorly preserved colossal doorway figures survives *in situ*, that of Y(F)-f. The Iraqi's have restored an arch above it². The walls were buttressed on either side of entranceways (Y)F-f, Y(G)-b, Y(S)-e, and, as restored, Y(WG)-g; these were the doorways that had colossi as part of the decoration.

About half of the more than eighty wall slabs that lined the courtyard survived either whole or in part; they were inscribed with the text of the Standard Inscription but not carved with figured decoration.

Completely or partially preserved wall slabs and socles. Y-1,2,3,4,5a, are in P: 1 and 2 have the Standard Inscription only); Y-5 to 9 (8, uninscribed, closes a niche which may once have been lined with wall slabs, behind which is the brick fill which closed off a corridor that led to room AG/AJ – evidence of a change in the plan of this corner of the palace which led to the harem quarters); Y-10 to 17; Y-28 to 47; Y-53 to 55; Y-60 and 61; Y-65 and 66; Y-70 to

76; Y-84 and 85; Y(G)-c-1 (socle and two fragments, one reconstructed *in situ*, the other Baghdad IM 29053; wingless genius, wearing helmet and carrying bucket and cone, facing [←]); Y(G)-c-2 (socle and Istanbul 6: wingless genius, wearing helmet and carrying bucket and cone, facing [→]); Y(S)-a-1 (lower half of the slab *in situ*, upper half in New York MMA 17.190.2077: winged geniuses standing back to back, the one facing courtyard Y carries a bucket and cone and faces [←]); Y(S)-a-2 (lower half of the slab *in situ*, upper half in New York MMA 17.190.2080: winged geniuses standing back to back, the one facing courtyard Y carries a bucket and cone and faces [→]). Layard numbered the slabs in Passage Z separately. Z-5 has the socle *in situ* and part of a lower portion of a genius facing (←); Z-10 has the socle and the lower two-thirds of a genius carrying a bucket facing (→), also *in situ*.

Missing wall slabs and socles. Y-18 to 27; Y-48 to 52; Y-52a; Y-56 to 59; Y-62 to 64; Y-67 to 69; Y-77 to 83; Y(WG)-d-1 and 2; Y(WG)-h-1 and 2.

Preserved lion colossi in situ. Y(F)-f-1 and 2.

Missing lion colossi. Y(G)-b-1, New York, MMA 32-143-2, winged lion facing (←); Y(G)-b-2, London, BM 118873, winged lion facing (→); Y(WG)-g-1, winged lion facing (←); Y(WG)-g-2, winged lion facing (→).

* The paved area was measured in 1976, at the end of the 3rd season of the Polish Excavations. The very limited time did not permit us to finish all the work. White areas on the plan do not determine existing pavement.

¹ The stone wall slabs and doorway figures were erected directly on the platform which served as a deck for the whole palace complex. The slabs were anchored from above by metal clamps and the floors, raised alongside of the walls, held them firmly in place along the bases. Removal of the pavement slabs eased access to the wall slabs when the latter were being taken away. Often when slabs were found in the collapse of roof materials, ceilings and walls on the floors of the palace halls and courtyards, they are broken at floor level. The wall slabs were easier to remove because of the way they were found; the colossal door figures had to be dug out in place.

² The excavation and restoration work of this doorway and adjacent areas is shown in Ameen Agha – al-Iraqi, *Nimrūd*, fig. 13. They were misidentified as "winged bulls" by Reade, *Iraq* 27, p. 131, though he was the first since Layard to mention that a pair of colossi still survived in this position. See also Salman, *Sumer* 29, fig. 3a (in the Arabic section) and Meuszynski, *Reliefdarstellungen* 1, p. 39.

Missing bull colossi. Y(S)-e-1, London, BM 118874, winged bull facing (←); Y(S)-e-2, New York, MMA 32-143-1, winged bull facing (→); Y(WG)-g-1 and 2.

Preserved inscribed pavement slabs. Y(F)-f – pavement between colossi broken into four pieces, threshold in front of the colossi is broken into seven pieces; Y(G)-c; Y(S)-a.

Missing inscribed pavement slabs. Y(G)-b, Y(S)-e, Y(WG)-d, Y(WG)-g, Y(WG)-h.

The signs of all the preserved, inscribed pavement slabs were turned in such a way that they could be read from the courtyard side of all entranceways. This must have been the case for all inscribed pavements in the doorway corridors.

Sets of thresholds and doorpost seats are missing for all nine doors, although a fragment of a stone paving has been restored inside WG at Y(WG)-g. See also the C-shaped stone in front of Y(F)-f-1, below. We have no information about whether or not this stone is inscribed³.

B. ACCORDING TO LAYARD

“The entrance formed by the pair of small human-headed lions discovered in chamber G, led me into a new hall, which I did not then explore to any extent, as the slabs were not sculptured.”
(Nin. I, p. 280)

“Three sides alone of the great hall Y, were found entire. From its size it is probable that it was not roofed in, but was an open court. It appears to have been nearly square; but the western wall has been completely destroyed; the slabs having been carried away to be used in the construction of the southwest palace. Three entrances are still standing. The one at *b*, formed by a pair of winged lions – those at *e* and *f*, by winged bulls. There was probably a fourth entrance on the western side, formed by a pair of lions, to correspond with that on the eastern; but I found no remains of it, although some might perhaps be discovered on a more careful examination. The removal of the slabs, which formed the western wall, has caused a depression in the mound; and consequently, if any large sculptures, such as the winged lions, had been left, when the slabs adjoining them were taken away, they would probably have been exposed to decay; and the upper part, remaining longest uncovered, would have been completely destroyed.”

(Nin. II, pp. 13–14)

“The slabs in hall Y were plain, having only the usual inscription. The bas-reliefs on those adjoining the lion, in chamber G, had been almost entirely destroyed, apparently by the action of water.”

(Nin. II, p. 75)

“I have already alluded (p. 67 of this volume) to the existence of a drain beneath almost every chamber in the

older palace of the Nimroud. These were connected with the floor by a circular pipe of baked clay, leading from a hole, generally cut through one of the pavement slabs, in a corner of the room. They joined one large drain, running under the great hall (Y, in plan 3) and from thence into the river, which originally flowed at the foot of the mound.”
(Nin. II, pp. 206–7)

Appendix:

“One side of this chamber has completely disappeared; that which remains is formed by unsculptured slabs with the usual inscription.

Entrance *f*. Winged bulls, facing chamber Y, and corresponding with those on the opposite side at entrance *e*.”
(Nin. I, p. 317)

“Entrance *b*, (to chamber G)

I quitted this chamber, after uncovering the upper part of four or five bas-reliefs; and returning to the entrance *a* (chamber G), traced to the south it two slabs upon which were groups similar to those on the opposite wall, except that the right hand of the king rested on the hilt of his sword, and not on the bow. On No. 27 was an eagle-headed figure, and beyond it was discovered another pair of human-headed lions, smaller than those forming entrance *a* of chamber B, but excelling them in the preservations of the details. The slabs on which they were carved were slightly cracked; but otherwise they appeared to have issued but the day before, from the hand of the sculptor. The accumulation of earth and rubbish above this part of the ruins was very considerable, and it is not improbable that it was owing to this fact that the sculptures had been so completely guarded from injury.”

(Nin. I, p. 127)

Appendix:

“(In chamber G)

21,22,27, Eagle-headed figures: facing entrances *c* and *b*.

26. Unsculptured with usual inscription.

Entrance *b*. 1 and 2, Human-headed winged lions: facing chamber Y.

Entrance *c*. 1 and 2. Colossal winged figures, holding fir-cone and basket; facing hall Y. 3 and 4, unsculptured, with usual inscription.”

(Nin. I, pp. 312–313)

Entrance e (to chamber S)

Appendix:

“(In chamber S)

26. A narrow slab divided by the usual inscription into two compartments, each containing a small winged figure, with horned cap, carrying basket and fir-cone.

³ If the stone is a doorseat it is in a secondary position. A doorpost would have obstructed the view of the sculpture. See the discussion below.

Entrances *b*, *c* and *d*, formed by colossal winged figures with the usual horned cap, bearing sacred flowers.
e. Winged bulls: facing chamber Y.”
 (Nin. I, pp. 315–6; for entrance *a*, see s.v. chamber [corridor] P, below.)

Entrance f (to chamber F)

See above s.v. Hall Y.

Chamber (corridor) P

“No. 1. Unsculptured, with usual inscription. 2,3,4. Colossal winged figures, with horned cap.
 The other slabs were unsculptured. They end abruptly at 4 and 5. The chamber is continued by a wall of sun-dried bricks.
 Entrance *a*. Two large slabs, each with two colossal winged figures, back to back, and facing respectively chambers S and Y.”
 (Nin. I, p. 315)

Chamber (corridor) Z

“A narrow passage, connecting hall Y with a chamber which has been completely destroyed.
 Nos. 1, 2, 6, 7, are narrow slabs, divided by the usual inscription into two compartments, each occupied by a small winged figure. On the remaining slabs are colossal winged figures, with horned cap.”
 (Nin. I, p. 317)

C. ACCORDING TO MALLOWAN

Chamber (passage) P

“There was much archaeological evidence to show that the Palace had been kept in an excellent state of repair over a long period of time. In the corridor P, for example, three pavements directly superimposed one over the other represented the passage of time between Assur-nasir-pal II and Sargon II, a period which amounted to about 160 years. Elsewhere in the southern wing four main periods of occupation were detected, with a fairly considerable rise in the last period of occupation, which must take us into the seventh century B.C., . . .”
 (*Iraq* 12, p. 180)

“In the passage P, Fig. I, which separates Layard’s wing from ours, the evidence from stratification is both clear and easy to demonstrate. There, at a depth of about 3 metres from the top, we found three successive stone pavements directly superimposed, one over the other. Of these three

stone pavements, the bottom was inscribed with the name of Assur-nasir-pal II, the founder of the palace; the next bore the name of his son and successor, Shalmaneser III; the uppermost pavement, though not inscribed, corresponded to pavements in JJ and HH in which room, as we have already stated, we found a document dated to the reign of King Sargon, in association with the ivories. There is no evidence to show that there was any substantial alteration in the plan or repair of the walls throughout this period, though some unimportant modifications were made in the S. E. Wing.”
 (*Iraq* 13, pp. 2–3)

D. COMPARATIVE ANALYSIS OF THE SOURCES

The courtyard was barely described by Layard and Mallo-
 wan.

Hall Y served as the central courtyard for the relief-decorated rooms of the palace. It was the second or third largest courtyard in the complex, ca. 27 m×36,5 m, or over 950 square meters in area. The largest courtyard was the Great Northern Courtyard, nearly three times the size of Y; the second largest was probably WT, the eastern face of which was over 50 m long⁴.

The North, South and East walls of Y were discovered by Layard, who did not expend any significant effort trying to trace the western wall: it and the “West Wing” seemed practically destroyed⁵. The Iraqi State Organization of Antiquities excavated here (final details as yet unreported) in the late 1960’s and restored the walls and buttresses based upon the traces of mudbrick and stone fragments which were discovered in the debris. The surviving wall slabs were reerected *in situ* along the restored walls, including the western wall of the courtyard, doorways were marked and an arch was built above the doorway Y(F)-f (and a second one above the doorway Y(S)-e).

As reconstructed, the western wall has three entrances, the center of which was decorated with bull-colossi. A three-door entrance arrangement suggests a throneroom and indeed the subject matter of the fragments of relief found there, the stone tracks for a brazier, and the other special paving stones strengthen that suggestion⁶.

According to the drawings published by Layard in *Nin. I*, frontispiece and *Nin. II*, frontispiece, the southern wall

⁴ If courtyard WT extended anywhere near the line of the citadel wall which ran some 35 m to the west, WT could have been 20% or more larger than courtyard Y. However, since the western wall of the palace is estimated to have been just over 20 m away to the west – this estimate based upon the proposed juncture between the western wall of the northwest corner of the complex and the southern wall of the complex at the southwest corner – the two courtyards might have been approximately the same size. See below, Chapter IV and Plan 3.

⁵ Rassam seems to have noted relief fragments in what is now called room WG. See Paley-Sobolewski, *Relief Representations II*, pp. 65 ff.

⁶ See Paley-Sobolewski, *Relief Representations II*, p. 70–71.

of the courtyard had survived intact when he discovered it. Some of the slabs must have been dismantled to enable the workmen to remove the bull-colossi. A number of these seem not to have survived. The reconstruction of this wall of the courtyard relies not only on the *in situ* remains of the brick wall and slabs, but also on Layard's drawings.

Originally, there were eighty-seven individual slabs, including the numbering of corridor (passage) P by Layard, lining the courtyard. Y(P)2–4 were carved with figures of geniuses; all the rest were cut only with the Standard Inscription, except slab Y–8 (uninscribed). The cuneiform signs are larger and the inscriptional bands are wider on these slabs than on those cut both with relief and inscription. There were 27 lines of inscription on each slab. Complete or portions of about 60% of these slabs survive. One of these slabs is now preserved in the Mosul Museum.

The floor of the courtyard was paved with terracotta and stone paving slabs. Either Shalmaneser III or Sargon II repaired this surface with another. It is the Ashurnasirpal pavement that is shown on the plan. The original pavement was laid on a layer of sand spread across the mudbrick deck upon which the whole palace complex was built. This process was repeated by the repairers. Bitumen was used as a sealant and fixent, as elsewhere in the palace. Underfloor drainage by means of clay pipes passed from the adjacent halls to join stonecovered troughs in this courtyard. The troughs led to other pipes which carried the water outside the palace walls, probably westward toward the Tigris River. The trough covers are distinguished on the central part of the plan as square pavement stones with holes in their centers through which the standing water in the courtyard could drain to the troughs below. The other holes, which served probably for the fastening of temporary decorative elements, were plugged with mushroom-shaped pottery vessels covered with a thin coat of bitumen⁷. The pavements also anchored the stone slabs, which lined the walls of the courtyard, securely in place.

Originally there were nine doorways to this courtyard, four of which – all buttressed, as outside entrances with colossi decoration were in this palace – had colossi in them: *e*, *f* – lion-*lamassu*; *b*, *g* – bull-*lamassu*. All the other doorways, except for the entranceway to passage (corridor) P, had decorated relief. On the basis of the extant examples, all these geniuses were helmeted, carried bucket and cone, and faced the courtyard. (See below, Catalogue, p. 36f. The slab with geniuses standing back to back in entrance Y(S)-a, should not be taken as an exception.)

The only colossi still *in situ* are the poorly preserved lion-*lamassu* in entranceway Y(F)-f. Inscribed pavements survive in rather delapidated states in entranceway Y(F)-f, Y(G)-c and Y(S)-a. The inscriptions are read from the courtyard side of the entranceways, emphasizing the fact that the courtyard acted as a center for access to the rooms that surrounded it. A paving stone was placed in the entrance to passage (corridor) Z at a later period. Decorated

with lines of rosettes, it seems to be Sargonid in date⁸. Since no stone pavement was discovered on the original surface of the entrance to passage (corridor) P, any thresholds, doorposts seats or paving stones may have been removed in antiquity. When the repairs were made, new pavement blocks repaved the original and then, later, the second surface. A different solution seems to have been adopted for passage (corridor) Z⁹. Finally a piece of pavement has been placed inside room WG at entrance Y(WG)-g by the Iraqi restoration team¹⁰.

E. RELIEFS IN COLLECTIONS OUTSIDE OF NIMRŪD

All known reliefs outside Nimrūd were identified by Gadd¹¹.

Y(G)-b-1. New York MMA 32.143.2

Y(G)-b-2. London BM 118873

Y(S)-e-1. London BM 118872

Y(S)-e-2. New York MMA 32.143.1

For the reliefs in entranceways Y(G)-c, see Meuszyński, *Reliefdarstellungen* I, p. 50. For the reliefs in Y(S)-a, see Paley-Sobolewski, *Relief Representations* II, pp. 46–47.

F. IDENTIFICATIONS AND RECONSTRUCTIONS

The door-colossi of Y(G)-b and Y(S)-e which were removed in the nineteenth century, were identified by Gadd¹². The geniuses of Y(G)-c were identified by Meuszyński¹³; those of Y(S)-a by Reade¹⁴. Fragments of Z-5 and 10 are *in situ*, as are many of the slabs that lined the courtyard walls now that the area has been reconstructed.

The lion-colossi are shorter in length but taller in height than the bull-colossi. It is to be noted that the northern and southern walls of this courtyard are thicker than the eastern and western walls. The relation between the height of the colossi and the thickness of the wall may have something to do with the height of the façades (second floors?) and the arches on the north and south side of the courtyard. The walls next to the doorways decorated with colossi were buttressed.

See also the discussion in section D, above.

⁷ One of our suggested uses for the so-called *siqqatu*.

⁸ *Op. cit.*, p. 59.

⁹ It is, of course, unknown what the exact sequence of events was that might help us date the repairs in the entrances to these two corridors. If the third repair of P coincides with the laying of the decorated slab in Z, who was responsible for removing the original thresholds and doorposts seats; or, are we mistaken in hypothesizing the existence of doorways to these passages in the first place? See above, n. 6.

¹⁰ See the (inscribed) floor slab on the north end of room BB(WK). *op. cit.*, p. 72.

¹¹ Gadd, pp. 125–7, 234, 238. See also Reade, *Iraq* 27, pp. 132, 134.

¹² *Loc. cit.*

¹³ Meuszyński, *Reliefdarstellungen* I, pp. 49–50.

¹⁴ Reade, *Iraq* 27, p. 134.

2. CATALOGUE

The wall slabs are inscribed with the Standard Inscription in 27 lines. Paragraph (para.) references to the end of the inscription are to Paley, *KW*, pp. 125 ff. It is interesting to note that with the possibility of inscribing the SI alone on the slab without interference of figural decoration, the scribes did not take care to space the inscription consistently so that all the copies would end in the same place. Narrow and wide inscriptions end where they end, sometimes even in mid sentence. It is the inscription as inscription that is important here, not the individual words or the text *per se*.

Y(P)-1 (W 1.49 m)

The slab overlaps P-2 and stands in the entrance to corridor P. There is a square hole for a closing mechanism on the right side of the slab in lines 8 to 11. The inscription was cut after the hole since no signs are missing in the text of the SI. The inscription ends: *pa-a 1-en ú-šá-áš-kín* (para. V.I).

(No. 2–4 are figured wall slabs in corridor P.)

Y-5a

Small uninscribed slab buried in the wall behind the end of Y-5, probably to help anchor the end of the line of stone slabs in place against the mudbrick wall. Clamps were used in the top of the slabs to hold them together.

Y-5 (W 0.87 m)

Narrow slab. No information available about the inscription on this slab.

Y-6 (W 1.68 m)

Wide slab with large signs. The inscription ends: *šá^{kurÉ} a-di-ni* (para. VI.C).

Y-7 (W 2.08 m)

Wide slab with large signs. The inscription ends: *ina KÁ(MEŠ)-šá ú-re-ti* (para. VII.B).

Y-8 (W 1.47 m)

Wide slab which stands in front of an area (alcove?) in the wall which may once have been the northern end of a corridor to the harem area of the palace. The southern end was closed off with brick fill. What remains is a closed space, which may once have been lined with slabs. (Another area in the wall is to be found further east in corridor P.). It is the only uninscribed slab in courtyard Y.

Y-9 (W 2.26 m)

Wide slab that fronts the north end of the eastern wall of room S. The slab abuts the back of the northern end of Y(S)-a-l. The inscription ends: *ina KÁ(MEŠ)-šá ú-re-ti* (para. VII.B).

Y-10 (W 2.04 m)

Wide slab at the Southern end of a wall segment on the east side of the courtyard. The southern edge of the slab abuts the back of the western end of Y(P)-1 and the western end of P-2. The inscription ends: *ina lib-bi ú-kín* (the end of the SI).

Y-11 (W 1.94 m)

Wide slab with large signs. The inscription ends: *ina KÁ(MEŠ)-šá ú-re-ti* (para. VI.B).

Y-12 (W 1.93 m)

Wide slab with large signs. The inscription ends: *ú-ma-am KUR(MEŠ)-e u A.AB.BA(MEŠ) šá^{na^api-li} BABBAR-e <u>^{na^apa-ru-te}* (para. VII.B).

Y-13 (W 1.91 m)

Wide slab with large signs. The inscription ends: *ina lib-bi ú-kín* (the end of the SI).

Y-14 (W 1.83 m)

Wide slab. There is no information about the inscription.

Y-15 (W 2.16 m)

Wide slab. There is no information about the inscription.

Y-16 (W 2.11 m)

Wide slab with large signs. The inscription ends: *ina lib-bi ú-kín* (the end of the SI).

Y-17 (W 1.60 m)

Narrower slab with large signs. This slab is at the northern end of this segment of wall and at entrance Y(G)-c. The inscription ends: *u^{kur} Ĥat-te u šá^m Lu-bar-na* – the end of the line is eroded (para. VII.C).

Y(G)-c-2 (W. 0.77 m)

The western end of the slab abuts the back of Y-17. The genius faces court Y. For this figure see Meuszyński, *Reliefdarstellungen I*, pp. 49–50, pl. 10.2.

Inscribed pavement slab between Y(G)-c-1 and 2. The inscription is nearly completely obliterated. Only a few signs survive. Based on preserved inscriptions and parts of inscriptions in other doorways, the inscription was probably a shortened version of the SI¹⁵.

Y(G)-c-1 (W 0.74 m)

See Meuszyński, *Reliefdarstellungen* I, pp. 49–50, pl. 10.2. The western end of the slab once abutted the back of Y-18. The genius faced court Y.

The wall segment between doorway Y(G)-c and Y(G)-b is destroyed and was not in existence in Layard's time. This means that Y-18 to Y-25 are missing.

Entrance Y(G)-b has been restored based upon the configuration of entrance Y(F)-f, that is, with buttresses. The colossi in this entrance were removed; one is in the Metropolitan Museum of Art in New York, the other is the British Museum, London.

Y(G)-b-2 (L 2.81 m; W 0.62 m; H₁ 2.91 m; H₂ 3.28 m)

Pl. 6.2

London. BM 118873 (50-12-28, 1 = N.G. 77). Winged, human-headed lion (or lioness) with five legs, facing (→). The helmet has three horns. The figure has human ears with conventional earrings. There is a halter rope around the animal's midriff. This figure and its pair in New York are taller than the bulls in entrances Y(F)-f and Y(S)-e, but not as long. This is probably because of the planned widths and heights of the walls – those of the east and west side of the courtyard may not have supported second floors, while those on the north and south did. The inscription begins behind the tail of the animal and continues between the legs as follows:

Behind the tail: É.GAL .. to .. *šá-ina* ^{gis}TUKUL-ti DINGIR(MEŠ) GAL(MEŠ) (line 6)

Between the rear legs: EN(MEŠ)-šú. DU.DU-ku-ma .. to .. MAN EN(MEŠ)-e mu-la-it (line 18)

Between the middle legs: *ek-šu-te a-pi-ir šá-lum-ma-te* .. to .. KA-a e-ta-nam-du-ru (line 22)

The inscription then omits *ú-sa-pu-ú EN-ti* .. to .. *ú-šá-pa-ri a-gi-iš ú-ma-'ru-ni* (line 25)

Between the front legs: *ina qí-bit Aššur* .. to .. *ina* ^{gis}GIGIR(MEŠ)-ia pa-tu-te (line 41)

Bibliography. Gadd, pp. 125 ff.; Schäfer-Andrae, 508 f.; Reade, *Iraq* 27, 132 f.; Madhloom, pl. LXX, 1; Meuszyński, *Reliefdarstellungen* I, pp. 49–50, p. 10.2.

The pavements, threshold and doorpost seats are missing.

Y(G)-b-1 (L 2.76 m; W 0.61 m; H₁ 2.95 m; H₂ 3.34 m)

Pl. 6.2

New York, MMA 32.143.2. Winged, human-headed lion wearing three-horned helmet and facing (←). It has human

ears and conventional earrings, five legs and a halter around its midriff. The inscription begins between the front legs as follows:

Between front legs: É.GAL .. to .. *hur-šá-ni DÛ-ši-na i-pe-lu-ma* (line 6)

Between the middle legs: *bi-lat-su-nu* – to EN-ti-[šú] MAN(MEŠ)-ni (line 20)

Between the rear legs: *ek-du-te la pa-du-te* .. to .. *lu aš-bat* (line 27)

Behind figure: *ina UD-me-šú-ma* .. to .. *iq-bu-ni* (line 40)

Bibliography: Porada-Hare, p. 8 (right); Crawford-Harper-Pittman, fig. 18 (p. 26)

Slabs Y-26 and Y-27 are missing.

Y-28 (W 1.76 m)

Wide slab on the front of the northern buttress. The inscription, with large signs, is eroded but ended: *ina lib-bi ú-kin* (the end of the SI).

Y-29 (W. 1.74 m)

Wide slab on the front of the northern buttress. The inscription, with large signs, is eroded but ended: *a-di* UGU A(MEŠ) *lu ú-šá-píl* ... (para. VI.D)

Y-30 (W 1.27 m)

Narrower slab on the front of the northern end of the northern buttress on the eastern wall of the courtyard, broken below the end of the inscription and badly eroded.

Y-31 and Y-32 (W. 0.88 m; W 0.46 m)

In a niche in the wall created by the end of the northern buttress and the north wall of the courtyard. No information about the inscription or the preservation of the slabs is available.

Y-33 (W 1.18 m)

Narrow slab in the corner, the first on the northern wall of the courtyard. The slab is broken below the inscription and badly eroded.

Y-34 (W 1.78 m)

Wide slab with large signs. The inscription ends: URU *šu-ú e-na-aḥ-ma iṣ-lal* URU *šu-ú* (para. VI.B)

Y-35 (W 1.89 m)

Wide slab with large signs. The inscription ends: É.GAL ^{gis}e-ri-ni É.GAL ^{gis}ŠUR.MÏN (para. VIIA)

¹⁵ Information about these pavement inscriptions was shared by John M. Russell who is preparing a catalogue of inscriptions in doorways of Assyrian palaces.

Y-36 (W 1.80 m)

Wide slab with large signs. The Inscription ends: *a-di* UGU A(MEŠ) *lu ú-ša-píl* (para. VI.D.)

Y-37 (W 0.81 m)

Narrow slab at the eastern end of the eastern buttress on the northern wall of the courtyard at doorway Y(F)-f. The inscription ends: *u* A.AB.BA GAL-*te*^{kur} *La-qi-e* (para. IV.B.2)

Y-38 (W 2.00 m)

Wide slab on the front of the eastern buttress of doorway Y(F)-f. The inscription is broken but the last line can be read as: ^š*e-ri-ni* ^š*ŠUR.MÎN* [...] AN.NA(MEŠ) KUR-*ti ŠU-ia* [...] (MEŠ) (para. VII.C)

Y-39 (W 2.09 m)

Wide slab on the front of the eastern buttress of doorway Y(F)-f. The inscription ends: *ú-še-zi-iz ú-si-im* (para. VII.B)¹⁶

Y-40 (W 2.17 m)

Wide slab on the front of the eastern buttress of doorway Y(F)-f. This piece makes the corner of the buttress at the entrance. The end of slab Y-41 rests against the back of its western edge. The inscription ends: *ina lib-bi ú-kín* (the end of the SI). (Figs. 8;10).

Y-41 (W 0.85 m)

Narrow slab on the western end of the eastern buttress of doorway Y(F)-f. This is a whole slab, eroded at the top. The inscription ends: ^u*Ra-pi-qi ana* *GÎR-šú ú-šék-ni-šá* (para. IV.B.2). (Figs. 8;10).

Y-42 (W 0.50 m)

Narrow slab in the alcove created by the end of the buttress and the right side of the bull-colossus. This is a whole slab, badly eroded, especially on the left side near to the colossus and on the top. Y-41-42 and the colossus itself are missing several centimeters off their tops. The inscription ends: *MU-[ia mu-šar]-bu-ú* (para. IV.A.1.). (Figs. 8;10).

Y(F)-f-1 (L 3.58 m; W 0.64 m; H₁ 1.80 m existing – 2.90 m reconstructed; H₂ 2.75 m existing – 3.10 m reconstructed) Pl. 6.1

In situ. Human-headed, bull-eared, winged bull with five legs (Figs. 8,10), facing right (→). The helmet has eroded away. There is also damage across the whole top of the slab, including the upper feathers of the wings and the beginning of the inscription behind them. As explained above the slab is longer than that upon which the lion-colossi of Y(G)-b were carved, to support the wider wall at this end

of the courtyard. This gives more space for the inscription behind the figure: the figure itself is approximately the same size, though if restored based upon the better preserved pair in London and New York which are assigned to entranceway Y(S)-e, it is taller.

There is a C-shaped stone in the pavement in front of the bull. The stone looks to be a seat for a doorpost – it is even stepped – but of a type different from those in room B and assigned to room WK (BB): it is not a pavement slab with a hole for the post carved out of it. Also, it is not inscribed. It is difficult to think of a doorway and doorpost obscuring figural decoration in this palace considering the pains taken by the planners to assure clear viewing of all such carved slabs. It may be part of the restoration of the palace in antiquity, or in modern times.

The inscription begins near the left edge of the slab and is eroded at the beginning of the first ca. 26 lines which mentions the palace, the king and the two generations that preceded him.

Behind the figure, the first readable signs are: *la a-di-ru* ^š*LAL* (line 4). The first completely readable line begins: *ana si-ḫír-ti-šá*^{kur} *Su-ḫi a-di*^u *Ra-pi-qi* ... (line 12). The column ends: *šá ina qi-it-ru-ub EN-ti-šú* MAN-(MEŠ)-*ni* (line 20)

Between the rear legs: *ek-du-te la pa-dute* .. to .. *šá*^{dÉ-a} MAN ZU.AB *i-ši-man-ni a-na iá-ši* (line 23)

Between middle legs: DINGIR(MEŠ) GAL(MEŠ) *šá* AN-*e u KI-tim* .. to .. *ana!* KUR-*ia Aššur lu ub-la-ši-na* (line 31)

Between front legs: *ina*^u *Kal-ḫi* .. to .. *ina É e-sir lu ad-di-šú-nu* (line 34)

Bibliography: Salman, *Sumer* 29, pl. 3a; Ameen Agha – al-Iraqi, *Nimrud* figs. 13, 14; Meuszyński, *Reliefdarstellungen* I, p. 39.

Pavements in doorway Y(F)-f (L 3.32 m; W 2.16 m).

Between the two bulls is an eroded pavement stone broken into four parts. It was inscribed with what seems to be a complete text of the Standard Inscription. There is a channel cut on the western side of the stone to channel water out of room F into the courtyard.

On the courtyard side of this pavement stone are the remains of an unscribed threshold broken into seven fragments.

Y(F)-f-2 (L 3.52 m; W 0.58 m; H₁ 2.85 m existing – 2.90 m reconstructed; H₂ 1.60 m existing – 3.10 m reconstructed) Pl. 6.1

Winged, human-headed bull (Figs. 9, 10). The stone has eroded badly. Most of the front of the figure is missing and

¹⁶ The pronoun *ši* is omitted, but this happens elsewhere. See Brooklyn 55.147 – *ú-šar-riḫ(-ši)*: Paley, *KW*, p. 132, n. 11.

¹⁷ See above, note 3.

the details of the feathers on the wing are almost obliterated. The inscription is also badly damaged, especially between the front legs and behind the wing at the top of the slab. The slab is longer than those of entrance Y(G)-b because of the width of the wall in which it stands. This is the same as its pair, Y(F)-f-1.

The inscription is preserved as follows:

Between the front legs. Eroded except for signs at very few points where the surface survives. The section ends: *ina malki*(MEŠ) *šá kib-rat* (line 3)

Between the middle legs: LIMMU-*ta šá-nin-šú la-u* TUK-ú .. to .. (the last lines are also damaged) ^{kur}*Lu-ul-[lu]-me-e* DAGAL(MEŠ) *ina qéreb* (line 9)

Between the rear legs: *tam-ḫa-ri ina* ^{is}TUKUL(MEŠ) .. to .. ^{id}*Su-ub-na-at a-di* ^{kur}*Ū-ra-ar-ḫi* (line 13)

Behind the figure: Eroded and unevenly preserved until (the first entirely readable line) *dan-nu-te ana pe-li šuk-nu-še ú šá-pa-ri a-gi-iš ú-ma-i'-ru-ni* (line 25) .. to .. *la ta-ta-píl ina pa-an Aššur ZI ši-i TI* (line 39)

The inscription goes right to the left edge of the stone. There is some damage, especially behind the knot in the tail.

Bibliography. Salman, *Sumer* 29, pl. 3 a; Ameen Agha – al-Iraqi, fig. 13; Meuszyński, *Reliefdarstellungen* I, p. 49.

The arch above the figures has been restored with new burnt bricks and with fragments of glazed brick found in the debris. The arch springs from the wall behind the door colossi rather from the top of the colossi themselves. This is understandable in a reconstruction of a part of the palace which is not well preserved. The tops of the figures, as noted, are eroded away and the slabs themselves are cracked in many places. Y(F)-f-1 has been clamped together so as not to fall apart. The arch was constructed so as not to damage the bulls.

The result may give the wrong impression, especially of the shape of the arch. In fact, it is reminiscent of the Sargonic arch, preserved at the time of discovery by the French at Khorsabad. Originally the arch should have sprung from the top of the colossi slabs. Slots for anchoring metal clamps, wood and brick were discovered on the tops of the “yellow limestone bulls” of doorway B-b¹⁸. We assume that the slots were a feature of all the colossi, for the purpose of anchoring slabs and arch together. The shape of the arch may also have been different.

Several of the glazed bricks had cuneiform signs painted on them and they have been mounted as part of the arch decoration along with semicircular bricks. The various bricks have been arranged to approximate the placement of a short inscription along the front of the arch. The inscription included the identification statement that this was the palace of Ashurnasirpal, king of Assyria, and gave his lineage¹⁹.

Y-43 (W 0.51 m)

Slab in the alcove to the west of Y(F)-f-2. It suffered the same damage as the front of the adjoining bull-colossus, especially at the top of the slab. The inscription ends: *ana GĪR-šú ú-šék-ni-šá* (para. IV.B.2) (Figs. 9.10).

Y-44 (W 0.86 m)

Slab on the eastern end of the western buttress of entranceway Y(F)-f. The surface of the upper third of the slab is broken off. The inscription ends: MAN šá TA *e-ber-tan* ^{id}ḪAL.ḪAL (para. IV.B.2) (Figs. 9.10).

Y-45 (W 2.10 m)

Wide slab with large cuneiform signs, on the face of the western buttress of entranceway Y(F)-f. The slab is eroded on top and on the side nearest the doorway. The end of the inscription is illegible. The last readable signs are: *ina KÁ-*(MEŠ)-*šá ú-re-ti* (para. VII.B). There is room for about 20 more signs which means that the text ended short of the phrase: *ina lib-bi ú-kiñ* (Fig. 10).

Y-46 (W 2.06 m)

Wide slab with large cuneiform signs, on the face of the western buttress of entranceway Y(F)-f. The slab was broken horizontally across the area of the inscription so that lines 20–22 are mostly destroyed on the right side and the last readable signs on line 27 are *a-na ma-'a-diš a[l-qa-a]*. The inscription originally ended: *ina lib-bi ú-kiñ*.

Y-47 (W 2.16 m)

Poorly preserved slab on the western end of the face of the western buttress of entranceway Y(F)-f. The slab was wide and had large cuneiform signs. Much of line 27 is missing, but the last sign is preserved. The inscription ended: *ina lib-bi ú-kiñ*.

Y-48-51

A small alcove was created by these slabs which comprise the western end of the western buttress (Y-48) of entranceway Y(F)-f, a wall slab on the northern wall of the courtyard Y-49), and two slabs which make its northwest corner (Y-50-51). Small fragments of slabs are laying on the ground and standing against the reconstructed brick walls. No complete slabs survive and there is no information about the inscriptions.

¹⁸ See above the discussion of the reconstruction of the center of the façade of the throneroom on the south side of the Great Northern Courtyard, pp. 17ff.

¹⁹ For a photo of the available bricks and brick fragments with decoration, see Ameen Agha – al-Iraqi, *Nimrūd*, figs. 15, 16.

Y(WG)-h-2.4

Y(WG)-h is a reconstructed doorway in the western wall of courtyard Y. The Iraqi restoration points to single slabs on the northern and southern sides of this entrance. Based on other doorway figures in the existing entrances of courtyard Y, of secondary importance: Y(G)-c and Y(S)-a, we restore here two slabs decorated with two genies standing back to back, one facing courtyard Y and a second one facing room WG.

The pavement in this doorway probably had all or a part of the SI inscribed on it. None survives.

Y(WG)-h-1.3

In this place would be a symmetrical arrangement on the opposite side of this entranceway. Two genies standing back to back, facing courtyard Y and room WG, respectively.

Y-52a

The restoration puts a narrow slab in this position, the back of which abuts the eastern end of Y(WG)-h-1.

Y-52

The restoration puts this slab at the end of the northern buttress of Y(WG)-g on the western wall of the courtyard. Its western end would have leaned against the left side of Y-52a. A narrow slab, it would have had an abbreviated version of the SI.

Y-53 (W 1.26 m)

Narrow slab on the face of the northern buttress of entranceway Y(WG)-g, on the western wall of courtyard Y. The right end of the slab abuts the back of the left side of Y-52. The inscription ends: *a-na* ÛKU(MEŠ) KUR-*ia am-nu* (para. IV.B.5).

Y-54 (W 1.79 m)

Wide slab with large cuneiform signs, on the face of the northern buttress of entranceway Y(WG)-g, on the western wall of courtyard Y. The inscription ends: É.GAL ^{gis}mes-ka[n-ni É.GA]L ^{gis}bu-ut-ni (para. VII.A).

Y-55 (W 1.72 m)

Wide slab with large cuneiform signs, on the face of the northern buttress of the entranceway Y(WG)-g, on the western wall of the courtyard. The inscription ends: É.[GAL] ^{gis}ŠUR.MĪN É.GAL [^{gis}dá]p-ra-ni (para. VII.A).

Y-56 and Y-57

These two slabs are missing. Y-56 formed the southern end of the northern buttress of Y(WG)-g, its right end abutted the back of the left end of Y-55. Y-57 formed the corner of

the alcove of the same entrance with Y-56. There is no information about the inscriptions, but the size of the slab suggests abbreviated Standard Inscriptions as in entrance Y(F)-f.

Y(WG)-g-1 (L ~ 2.90 m; W ~ 0.62 m; H₁ ~ 2.90 m; H₂ ~ 3.30 m) Pl. 7.2

Missing. Human-headed, winged lion wearing a horned helmet, facing (→). This figure would match Y(G)-b-2 and would be inscribed with the appropriate inscription. The width of the restored western wall of the courtyard suggests that this lion colossus was the same size as the one on the opposite side of the courtyard.

The pavement, threshold and door seats that would have been placed in this doorway are missing. A pavement slab with a small step on its western side has been placed on the room WG-side of the entranceway; but whether or not this is the original position for this slab is not clear.

Y(WG)-g-2 (L ~ 2.90 m; W ~ 0.62 m; H₁ ~ 2.90 m; H₂ ~ 3.30 m) Pl. 7.2

Missing. Human-headed, winged lion wearing a horned helmet, facing (←). This figure would match Y(G)-b-1 and would be inscribed with the appropriate inscription. The width of the restored western wall of the courtyard suggests that this lion colossus was the same size as the one on the opposite side of the courtyard.

Y-58

Missing. A narrow slab on the western wall, in the alcove beside the lion colossus. The inscription would have been abbreviated.

Y-59

Missing. A narrow slab on the northern end of the southern buttress of entranceway Y(WG)-g, set at a right angle to Y-58, its right end abutting against the left side of that slab, and forming the corner of the southern side of the alcove. The inscription would have been abbreviated.

Y-60 (W 2.14 m)

Wide slab with large cuneiform signs, on the face of the southern buttress of entranceway Y(WG)-g, on the western wall of courtyard Y. The slab is badly damaged. Much of the bottom of the slab is broken away and the rest has been elevated to simulate the position of the surviving fragments. The last readable signs on line 27 are: *ú-re-ti* KÛ-BABBAR [...] [ZABAR(MEŠ) AN.BAR] (MEŠ) <KUR-ti ŠU-ia> šá KUR.KUR [...] (para. VII.C)

Y-61 (W 2.08 m)

Wide slab with large cuneiform signs, on the face of the

southern buttress of entranceway Y(WG)-g, on the western wall of courtyard Y. The inscription ends: ZABAR(MEŠ) [ŠU-]ia šá KUR.[KUR ... There may be enough room for the remainder of the SI to *ina lib-bi ú-kin*.

Y-62

Missing. The southernmost slab on the face of the southern buttress of entranceway Y(WG)-g, on the western wall of courtyard Y. This was a narrow slab and most probably had an abbreviated inscription.

Y-63

Missing. This slab was on the end of the southern buttress of entranceway Y(WG)-g. Its right end abutted the back left side of Y-62. The slab was narrow and most probably had an abbreviated SI.

Y-64

Missing. This slab made the right angle with Y-63 and was placed on the western wall of courtyard Y. A narrow slab, it most probably had an abbreviated inscription.

Y-65 (W 2.15 m)

Wide slab, badly damaged. About half of the inscription is gone from the right side of the last line (27). The last readable signs are: KÛ.BABBAR(MEŠ) GUŠKIN(MEŠ) AN.NA(MEŠ) ZABAR AN.BAR [...]. It is then eroded for about 10 more signs and the end is completely broken away. The text could have ended: *ina lib-bi ú-kin*.

Y-66 (W 2.16 m)

This is the last slab before entranceway Y(WG)-d. It is badly broken and part of the lower left hand side of the slab is gone. Originally, the right end of Y(WG)-d-2 rested against the back of the left end of this slab. It was a wide example; the inscription, mostly eroded away, ended: *ina lib-bi ú-kin*.

Y(WG)-d-2.4

Missing. Based upon the parallels in the restorable entranceways to courtyard Y, here should be two slabs decorated with two genies standing back to back, one facing courtyard Y, and a second one – facing room WG. See above, Y WG-h.

No pavement slab, threshold or seats for a doorpost are preserved.

Y(WG)-d-1.3

Missing. The matching pairs to Y(WG)-2.4. Two genies standing back to back, one facing courtyard Y, and a second one-facing room WG. See above, Y(WG)-h.

Y-67

Missing. A wide slab on the wall, south of entranceway Y(WG)-d. Originally, the left end of Y(WG)-d-1 abutted the back of the left side of this slab. The inscription may have been complete to: *ina lib-bi ú-kin*.

Y-68

Missing. A wide slab on the wall, south of entranceway Y(WG)-d. The inscription may have been complete to: *ina lib-bi ú-kin*.

Y-69

Missing. A wide slab on the wall, south of entranceway Y(WG)-d. The inscription may have been complete to: *ina lib-bi ú-kin*.

Y-70

Only a fragment of this wide slab is *in situ* – about one third of the lower left hand section. It is the last slab on this section of wall before the entrance to corridor (passage) Z. The last line of the inscription (27) is preserved as follows: AN.BAR(MEŠ) KUR-ti ŠU-[ia ... (para. VII.C). There would have been room for the remainder of the text of the SI.

Z-10 and Z-5. Entranceway to corridor (passage Z). For these reliefs and the pavement stone between them, see Paley-Sobolewski, *Relief Representations* II, pp. 62–64. Both figures face courtyard Y. No original threshold or seats for doorposts are preserved.

Y-71 (W 1.49 m)

Wide slab on the south wall of courtyard Y. Its right side is tucked behind the left edge of Z-5. No information is available about the inscription.

Y-72 (W 2.00 m)

Wide slab on the south wall of courtyard Y. No information is available about the inscription.

Y-73 (W 1.45 m)

Narrow slab on the south wall of courtyard Y. This slab makes a corner with Y-74. No information is available about the inscription.

Y-74 (W 1.00 m)

Narrow slab on the western end of the western buttress of entranceway Y(S)-e. The inscription ends: *a-di^{kur}Haš-mar* (para. IV.B.5).

Y-75 (W 0.66 m)

Narrow slab on the face of the western buttress of entranceway Y(S)-e. No information is available about the inscription.

Y-76 (W 2.10 m)

Wide slab on the face of the western buttress of entranceway Y(S)-e.

Y-77

Missing. Wide slab on the eastern end of the western buttress of entranceway Y(S)-e.

Y-78

Missing. Narrow slab on the eastern end of the western buttress of doorway Y(S)-e.

Y-79

Missing. Narrow slab on the south wall of courtyard Y, in the western alcove of entranceway Y(S)-e. This slab and Y-78 make the corner of this part of the alcove.

Y(S)-e-2 (L 3.10 m; W 0.61 m; H₁ 2.89 m; H₂ 3.09 m)

Pl. 7.1

New York MMA 32. 143.1. Winged, human-headed bull-*lamassu* with five legs. The figure wears a three horned helmet and faces (→). On the size of this figure relative to the other door colossi that face this courtyard, see above Y(WG)-g, Y(F)-f, and Y(G)-b.

The inscription is preserved as follows:

Behind the figure: É.GAL .. to .. *a-di* ^{kur}*Lab-na-na u* ^{kur}*né-reb* (line 11)

Between the rear legs: GIM ⁴*IŠKUR ra-ḫi-še* .. to .. *mu-la-iṭ ek-šu-te a-pi-ir* (line 18)

Between the middle legs: *ša-lum-ma-te la* *⟨a⟩di-ru* ^š*LAL* .. to .. A[N].NA(MEŠ) (line 29)

Between the front legs: ZABAR(MEŠ) ÚTUL(MEŠ) ZABAR .. to .. *ú-ša-li-di* (line 35)

Bibliography: Layard, *Nin.* I, frontispiece; Layard, *Nin.* II, frontispiece; Gadd, pp. 127, 134; Porada-Hare, p. 8; Paley, *KW*, p. 72, *BMetMus* 1933, p. 17; MMA, *Guide* (1966), fig. 29; Meuszyński, *AA* 1976, p. 471; Crawford-Harper-Pittman, fig. 18 (p. 26); Paley-Sobolewski, *Relief Representations* II, p. 49.

There are no thresholds, pavements stones or seats for doorposts preserved in this entranceway.

Y(S)-e-1 (L 3.14 m; W 0.60 m; H₁ 2.89 m; H₂ 3.10 m)

Pl. 7.1

London BM 118872 (50-12-28.2 = N.G. 76). Winged, human-headed bull-*lamassu* with five legs. The figure wears a three-horned helmet and faces (←). For the size of this figure relative to other door colossi facing room Y, see Y(WG)-g, Y(F)-f, and Y(G)-b.

The inscription is preserved as follows:

Between the front legs: É.GAL .. to .. *mu-pa-ri-ru* (line 5)

Between the middle legs: *ki-iš-ri mul-tar-ḫi* .. to .. *ana mi-iš-ri KUR-ia* [*ú*]-*te-ri* (line 15)

Between the rear legs: TA ^{kur}*né-re-be šá* ^{kur}*Ba-bi-te* .. to .. *ú-ša-az-ni-ni* (line 22)

Behind the figure: *nab-li mul-mul-li* .. to .. *am-ḫur-šú-nu* (line 31)

Bibliography: Layard, *Nin.* I, frontispiece; Layard, *Nin.* II, frontispiece, pp. 74ff.; Budge, *AS*, pl. V; Gadd, pp. 127, 134; Reade, *Iraq* 27, p. 134; Strommenger, *5000 years*, pls. 198–9; Paley, *KW*, p. 72; Madhloom, pl. LXX,2; Meuszyński, *AA* 1976, p. 470; Paley-Sobolewski, *Relief Representations* II, p. 49.

Y-80

Missing. Narrow slab in the eastern alcove of entrance Y(S)-e, on the southern wall of the courtyard. It made the corner with Y-81.

Y-81

Missing. Narrow slab in the eastern alcove of entrance Y(S)-e, on the western end of the eastern buttress of the doorway. See above, Y-80. Its left end abutted the rear of the right side of Y-82.

Y-82

Missing. Wide slab on the face of the eastern buttress of entranceway Y(S)-e, on the southern wall of courtyard Y.

Y-83

Missing. Wide slab on the face of the eastern buttress of entranceway Y(S)E-e, on the southern wall of courtyard Y.

Y-84 (western leg W 0.60 m; southern leg W 0.82 m)

Corner slab at the eastern end of the eastern buttress of entranceway Y(S)-e, on the southern wall of the courtyard. This is the only such slab in the courtyard. No information is available about the inscription.

Y-85 (W 0.41 m)

Narrow slab on the eastern end of the eastern buttress of entranceway Y(S)-e, at entranceway Y(S)-a. The left side of the slab is tucked slightly behind the right side of Y(S)-a-2. There is no information about the inscription available.

Y(S)-a, 1 and 2. On these two slabs which form the entranceway to room S, east of the eastern buttress of entranceway Y(S)-e, see Paley-Sobolewski, *Relief Representations* II, pp. 46–47. The geniuses facing courtyard Y wear helmets and carry pails and cones. The left end of Y(S)-a-1 abutted the rear of the right side of Y-9.

Pavement in the entranceway (L 2.53 m; W 0.84 m).

The narrow pavement slab between the two wall reliefs was inscribed with the Standard Inscription, the end of which is eroded away. How much of the full text of the SI cannot be determined any longer. The last clear signs are *u A.AB.BA* ... (para. IV.B.2). There were originally more than 46 lines of text on the slab.

IV. Courtyard WT

1. WALLS AND ENTRANCES

A. PRESENT CONDITION

This chapter will review some of the information collected for the discussion of the West Wing in *Relief Representations* II, pp. 65–7, 72–3. Also see *Reliefdarstellungen* I, Plans 1.2; *Relief Representations* II, Plans 1.2. Restoration by the Iraqi State Organization of Antiquities did not extend beyond a segment of wall between entrances WT (BB/WK)-d and WT(BB/WK)-b and the area immediately around WT(BB/WK)-a, including the eastern parts of rooms AB and AA. It was in WT(BB/WK)-a that Layard discovered a pair of winged lion-colossi. We have no current information concerning the status or preservation of the colossi beyond the record left to us by Layard in his publications and a single drawing. Our restoration below is therefore very hypothetical. The edge of the citadel mound and the beginning of the descent to the old bed of the Tigris begins just beyond the remains of the eastern façade of WT.

B. ACCORDING TO LAYARD

Western Façade and WK

“The two gateways formed by the sphinxes with the human form to the waist (see woodcut at head of chapter XVI), appear to have flanked a grand centre portal to which they were united on both sides, as in Sennacherib’s palace, by colossal figures of human-headed bulls and lions and winged priests. The remains of no other great entrance to the palace have yet been discovered, but I have little doubt from several indications in the ruins, that there was a similar façade on the river side, and that a terrace, ascended by the broad flight of steps, overlooked the Tigris.”
(*Nin. Bab.* pp. 654–5 – see also plan III in that publication.)

Entrance to chamber “BB” (WK)

“A pair of winged lions, the heads and upper part destroyed, were also discovered. They appear to form an entrance into a chamber, were admirably designed and very

carefully executed. . . I uncovered only the upper part of these sculptures.”

(*Nin.* I, pp. 59–60; see also p. 64)

“The workmen were directed to dig behind the small lions, which appeared to form an entrance, and to be connected with other walls. After removing much earth, a few unsculptured slabs were discovered, fallen from their places, and broken in many pieces. The sides of the room of which they had originally formed a part could not be traced.”

(*Nin.* I p. 70)

Appendix:

“Unsculptured slabs, the greater part destroyed. Entrance *a* is formed by two small winged lions.”

(*Nin.* I, p. 317)

Chamber “AB”

“The newly discovered chamber was part of the north-west palace, and adjoined a room previously explored. (It was parallel to, and to the south of, the chamber marked AA, in the plan of the north-west palace. [*Nineveh and its remains*, vol. I, Plan III.]) Its only entrance was to the west, and almost on the edge of the mound. It must, consequently, have opened upon a gallery or terrace running along the river front of the building. The walls were of sun-dried brick, panelled round the bottom with large burnt bricks, about three feet high, placed one against the other. They were coated with bitumen, and, like those forming the pavement, were inscribed with the name and usual titles of the royal founder of the building. In one corner, and partly in a kind of recess, was a well, the mouth of which was formed by brickwork about three feet high. Its sides were also bricked down to the conglomerate rock, and holes had been left at regular intervals for descent. When first discovered it was choked with earth. The workmen emptied it until they came, at the depth of nearly sixty feet, to brackish water. (Few wells in the plains bordering on the Tigris yield sweet water.)”(*Nin. Bab.*, pp. 176–177)

C. COMPARATIVE ANALYSIS OF THE SOURCES

It is not certain whether Layard meant the WT-façade we hypothesize here, or an entrance on the river-side of the palace which fronted the Northwest Wing of the palace and passage to the Great Northern Courtyard. Mallowan seems to have had the latter opinion at the beginning of his deliberations. See above, Chapter I, p. 9.

The size of the courtyard depends on how one reconstructs the western wall of the citadel mound and the western wall of the palace. See below.

We assume that there was no figural decoration on the wall slabs of this courtyard as in courtyard Y. Layard mentioned that a few fragments of unsculptured slabs were found "behind" the lion-colossi. However, we have considered other possibilities.

The lion-colossi of entranceway WT(BB/WK)-a should still be *in situ*. Despite Layard's remark that he did not have the lions completely excavated by his workmen, there does exist a drawing of a figure, shown to the socle, from the south side of the doorway. The first signs of each column of the preserved inscription are marked on the drawing. Also, the variants of the inscription on these lions are buried in the footnotes to this text as published in *Inscriptions in Cuneiform Character*, pl. 43–5.

The passage citing the excavation of chambers "AA" and "AB" explains the damage to the palace at its furthest, preserved, western extremity. The well mentioned there is not indicated on our plan (Relief Representations II, Plans 1.2).

D. RECONSTRUCTION

We begin with a discussion of the size and shape of this courtyard. Since the placement on the plan of the western, northern and southern walls of the space is a matter of conjecture, this is a difficult subject to broach. The reconstruction on Plan 3, comes from the following deliberations (see above, p. 40):

1. The line of the western wall of the courtyard is established by assuming that:
 - a. the external walls of the palace on the east and west were the same width;
 - b. the corner at WT 19 was an inside corner of a room, the western wall of which was the western wall of the palace; and
 - c. that the southern wall of the palace made a corner with the western wall, (The exact position of the southwest corner makes little difference as long as the configuration of the framework (grid) within which the palace itself is placed can help determine the direction and situation of the western wall).

The result is a wall ca. 23 m to the west of the eastern façade of the courtyard. Whether this wall had an entrance or entrances which might have led to a narrow street between

it and the acropolis wall, or to a bridge crossing to the ramparts of the acropolis wall, is pure speculation. The technical engineering for the later type of construction was surely at hand¹.

2. The position of the northern wall of the space is inferred by adding a fourth room to (the remains of) three small rooms west of the throneroom complex. The southeast corner of the southern wall of this set of rooms as preserved, suggests that the corridor's west wall continued further south.

The reconstruction has been limited to one more room, slightly narrower than the others. The line of the crossing wall at the southwest corner of room WI has been used as the limit of this group of small rooms. Access to these (now) four small chambers cannot be marked on the plan because of preservation, but it is assumed that there were doorways both on the courtyard WT-side and on the Northeast Wing-side, as well as from one to the other. Another small room also been added across from and east at the fourth room, with an entrance to it from the corridor.

3. It is even more difficult to locate the position of the southern wall. The area around entrance WT(BB/WK)-a seems empty enough to suggest that the southern wall of the courtyard should be an extension of the wall that divides room AA from AB. A corridor has been provided west of rooms AA and AB, opposite the reconstructed corridor leading away from the north wall, the idea copied from the positions of corridors P and Z at two sides of one end of courtyard Y. Additional rooms must therefore be provided to fill the space limited by the proposed walls in the reconstruction on the plan.

The result is a long rectangular courtyard, ca. 49 m long × 23 m wide, or 1127 sq. meters in area, the second largest courtyard known in the palace. See above the discussion of the size of courtyard Y, p. 34. A courtyard of this size deserves a special set of doorways, as is explained below.

The reconstruction of the southern wall of the courtyard was based upon the throneroom façade. The reason for this not only relied upon Layard's remarks quoted above², but also on the drawing he made of one of the lion-colossi of entranceway WT(BB/WK)-a. This drawing shows the badly preserved remains of a lion-colossus, at the front of which is a protruberance, the position of which suggests to us not the bottom of the head and beard of the conventional figure (it is too low) but the arms and chest of the same type of lion-colossus which we have described in entranceways E(B)-c and E(D)-d, above, pp. 5 f., 23 f.³ It is not possible to say which of the two types of lion-colossus with human torso (with hands folded or carrying an animal) stood in the doorway. The choice was made to choose the simpler of the two possibilities.

¹ See the bridge that connected the palace to the Nabû Temple at Khorsabad, dated in the next century.

² Layard, *Nin. Bab.*, pp. 654–655.

³ See below, *Catalogue*, item 9a.

The identification of such a figure on this courtyard's façade suggests further that there was another entranceway between WT(WK/BB)-a and WT(WK/BB)-d, probably decorated with large bull-colossi. The courtyard wall has also been provided with buttresses, the remains of one of which were discovered by the Iraqi excavation and restored. This is the buttress between entranceways WT(WK/BB)-d and WT(WK/BB)-b.

Therefore, looking at the wall from the courtyard side, this façade had the bull-colossi in the center doorway, flanked by pairs of lion-colossi in side doorways, and then two plain doorways at the extreme ends, north and south, of the wall. This could have been a unique façade for the special room WK(BB), which lay behind it⁴.

Since no slabs with figural decoration were discovered in the area of this courtyard, we assume that the slabs of courtyard WT were only inscribed with the Standard Inscription although perhaps the central doorway did have figural decoration adjacent to the bull-colossi (see Plan 3). We do not know the height of the palace wall on the western side of the courtyard, or of the citadel wall for that

matter. Therefore, we also do not know whether this façade was visible from the river as was suggested by Layard in his comparison with the palace of Sennacherib at Nineveh⁵.

⁴ This is not the place to speculate at any great length about the purpose of this room, at one end of which is a large grooved pavement with a section of the annals inscribed on it. On the Plan 2, published in *Relief Representations II*, this slab is positioned at the large entrance of another small room WI. Room WI is of the character of the so-called "bathroom" (see rooms: I.L.V in the NW Palace). This configuration is not conventional in these palace suites. For this reason we adopted here a conception which was presented by J. Reade in Iraq 47, p. 208. (see our Plan 3). We repeat here a fragment of Reade's discussion:

"It is also unlikely that the south door of Room WI, leading to WT, is an original feature: Room WI is obviously a bathroom, part of lay-out corresponding roughly to Rooms T 22-4 in the equivalent part of the state apartments in the arsenal (Mallowan 1966: III, Plan VIII), and can hardly have had an original door leading directly into Room WK, though one might have been cut in the eighth century."

⁵ See Paley-Sobolewski, *Relief Representations II*, pp. 72-3, with references.

2. CATALOGUE

1. Missing. Western segment of the southern wall: slabs with SI only.

2. Missing. Entranceway to a corridor. The width of the southern wall of the courtyard as established by the width of the southern wall of room AA suggests that there was room for only one slab in the east and west sides of the entranceway to the proposed corridor.

3. Missing Eastern segment of the southern wall: slabs with SI only.

4. Missing. Short segment of the eastern wall of the courtyard; probably one slab with only an abbreviated version of the SI.

5. Missing. Entranceway to room AA. The width of the thick eastern wall of the courtyard suggests that this was an entranceway with four slabs, arranged so that a door could be positioned in it, i.e. the ones on the WT side closer together than those on the AA side, and with some overlapping. The slabs were probably inscribed with the SI only.

The pavement slab in the doorway was probably inscribed with a version of the SI. The threshold and seats for the doorposts were probably inscribed with the royal titulary. See above entranceway WT(WK/BB)-e. The configuration adopted for this entranceway's slabs is that of H(G)-e. See below, s.v. no. 21.

6. Missing. Two slabs, one north of the doorway, the other at right angles to it. The second slab was against the

southern wall of the buttress. Both were probably inscribed only with the abbreviated version of the SI.

7. Missing. Slabs along the face of the buttress, inscribed probably with the SI only.*

8. Missing. Southern part of the alcove of entrance WT(WK/BB)-a: two slabs, the first on the northern end of the buttress, the other at right angles to it, one end inserted behind the front of the door colossus. Probably inscribed with short versions of the SI.

9. Entrance WT(WK/BB)-a

a. WT(WK/BB)-a-1 (L ~ 2.25 m; W ~ 0.55 m; H₁ ~ 2.30 m; H₂ ~ 2.45 m) Pl. 8.1

Winged-lion with human torso, facing (→). Layard described the figure as small. The knot on the tie-cord in the drawing is disproportionately large. According to the notations on the drawing, the inscription could have been preserved as follows:

Behind the figure: missing to GÚ *a-a-bi-šú(?)* then perhaps preserved to TA ^{kur}*né-reb* (line 16)

Between the rear legs: *šá kurBa-bi-te* .. *pa 1-en* (line 21)

Between the middle legs: *ú-šá-áš-kín* .. to .. *a-na KUR-ia Aššur* (line 31)

* For the slabs 1-7, see *Relief Representations II*, Plans 1.2.

Between the front legs: *lu-ú ub-la-ši-na* . . . (perhaps) *ina URU-ia* ^{uru} *Kal-ḫi lu-ú ak-šur* (line 37)⁶

Bibliographie: OR. DR. N.W. IV. Misc 4. Reade, *Iraq* 27, p. 134; Paley-Sobolewski, *Relief Representations* II, pp. 65, 67, 72.

b. Pavement slabs. There is no record of a pavement slab in this doorway. It was probably inscribed with a version of the SI. The inscribed threshold and doorpost seats are also missing.

c. WT(WK/BB)-a-2 (L ~ 2.25 m; W ~ 0.55 m; H₁ ~ 2.30 m; H₂ 2.45 m) Pl. 8.1

Companion to the winged lion-colossus of WT(WK/BB)-a-1. There is no information other than Layard's brief description that it was there. It faced (←).

Bibliography: See above, s.v.a.

d. WT(WK/BB)-a-3 and 4.

Missing? Two narrow slabs inscribed with the SI only, the right and left ends inserted behind the backs of the door colossi. The threshold and doorpost seats were probably between these two slabs. These may have been among the fragments of the wall slabs mentioned by Layard in one of the descriptions of the discovery of this doorway area.

10. Missing. Two slabs in the northern part of the alcove of the entrance. One stands on the wall, the other at right angles to it, on the southern end of the buttress between entranceways WT(WK/BB)-a and e. Both were inscribed, perhaps with abbreviated versions of the SI only⁷.

11. Missing. Series of slabs (6?) along the face of the buttress between the two doorways mentioned above (s.v. 10). Inscribed only with the SI.

12. Missing. Two slabs in the southern part of the alcove of entranceway WT(WK/BB)-e. One is on the northern end of the buttress mentioned above, the other, at right angles to the first, against the wall. The left end of this latter slab was inserted behind the front of the colossus to its left. We assume that both of these slabs were inscribed only with the SI. However, it is also possible that at least the slab next to the colossus was decorated with figural design. On the possibilities for the decoration in reliefs of one, two or three registers (including the possibility of a Standard Inscription only) in an important central doorway such as this one, see the discussion of door ED(B)-e, above, pp. 17f. The slab on the end of the buttress could also have had a helmeted 4-winged genius with bucket and cone.

13. Entrance WT(WK/BB)-e – (the central doorway of this façade),

a. WT(WK/BB)-e-1 (L ~ 3.30 m; W ~ 0.60 m; H₁ ~ 3.30 m H₂ ~ 3.60 m)

Missing. Winged, human-headed bull-colossus wearing a horned helmet, and facing (→). This figure is suggested because of the established principal of alternating lions and bulls in the entranceways of this palace. Because this figure is in the central doorway of the façade, it is larger than the lions flanking it.

b. There is no record of the pavement that we assume was once on the floor of the entranceway between the two figures. It was probably inscribed with a version of the SI. The inscribed threshold and doorposts seats are also missing. A set of thresholds with door seats has been assigned to the room WK side of this entranceway. They were inscribed with copies of the lineage of the king of the palace; one of the copies identified the set with the "second house"⁸ (Plans 3.5).

c. WT(WK/BB)-e-2 (L ~ 3.30 m; W ~ 0.60 m; H₁ ~ 3.30 m; H₂ ~ 3.60 m)

Missing. The companion figure to WT(WK/BB)-e-1, facing (←).

14. Missing. Two slabs in the alcove of the entranceway WT(WK/BB)-e. One stands against the wall (for its decoration see above, no. 12). The other is on the southern end of the buttress which stretches between entranceways WT(WK/BB)-e and WT(WK/BB)-d. The latter slab was probably inscribed with an abbreviated version of the SI only, but could also have had the figure of a helmeted, 4-winged genius with bucket and cone.

15. Missing. Series of wall slabs (6?) on the face of the buttress north of WT(WK/BB)-e. They were probably all inscribed with only the Standard Inscription.

16. Missing. Two slabs in the southern part of the alcove of entrance WT(WK/BB)-d. One was situated on the northern end of the buttress mentioned above, s.v. 15, and inscribed with a version of the Standard Inscription. The other was at a right angle to it and on the wall, its left end inserted behind the colossus to its left. It was also inscribed with a version of the SI, probably abbreviated.

17. Entrance WT(WK/BB)-d

a. WT(WK/BB)-d-1 (L ~ 2.25 m; W ~ 0.55 m; H₁ ~ 2.30 m; H₂ ~ 2.45 m)

Missing. Winged lion colossus with human torso. The figure was probably similar to one of those suggested for the entranceway WT(WK/BB)-a. The figure faced (→). See above s.v., n. 9.

b. Missing. A pavement slab, probably inscribed with a version of the SI. The inscribed threshold and doorpost seats are also missing.

c. WT(WK/BB)-d-2 (L ~ 2.25 m; W ~ 0.55 m; H₁ ~ 2.30 m; H₂ ~ 2.45 m)

Missing. Winged lion colossus with human torso. The figure was probably similar to one of the types suggested for the entranceway WT(WK/BB)-a. The figure faced (←). See above s.v., n. 9.

⁶ This assumes that the inscription ended at the close of a sentence, which is not always the case on other examples. Also, the scribe would have had to omit all or at least some of the MEŠ-signs to have had enough room to reach this point in the text.

⁷ In one of his descriptions of the discovery of these lion colossi, Layard notes that the fragments of wall slab in the immediate area were inscribed only with the Standard Inscription; there was no figural relief.

⁸ Paley, JANES, 1989

d. WT(WK/BB)-d-3 and 4

Missing. Two narrow slabs with abbreviated SI only, the right and left ends inserted behind the backs of the door colossi. The threshold and doorpost seats were probably between them.

18. Missing. Two slabs in the northern part of the alcove of entranceway WT(WK/BB)-d. One on the wall, inscribed with a short version of the SI; the other on the southern end of the buttress north of this entranceway at a right angle to the first slab and also inscribed with a version of the SI.

19. Missing. The series of slabs (3?), inscribed with versions of the SI, which once lined the face of this buttress. The buttress was restored by the Iraqi State Organization of Antiquities.

20. Missing. Two slabs in the southern alcove of entranceway WT(WK/BB)-b. One was placed on the southern end of the buttress south of this doorway. It was probably inscribed with a version of the SI only. The other was on the wall, at a right angle to the first. It abutted the back of the right end of WT(WK/BB)-b-1 and was probably inscribed with an abbreviated version of the SI only.

21. Entranceway WT(WK/BB)-b. This entranceway was made up of four slabs, two of them probably inscribed with abbreviated versions of the SI and others two decorated with genies. The mudbrick walls on both sides of the entranceway have been restored by the Iraqi State Organization of Antiquities. The configuration of the entranceway is similar to that of H(G)-e: this is the same configuration used for our reconstruction of WT(AA)-h; see above s.v. no. 5. The inscribed pavement slab is also missing – it lay

between WT(WK/BB)-b-1 and 2 – as are the inscribed threshold and doorposts, which lay between WT(WK/BB)-b-3 and 4. For the view through this doorway, see above, note 4.

22. Missing. A slab on the restored wall, the right end of which abutted the back of the left side of WT(WK/BB)-b-2. The slab made the northeast corner of WT with a slab that stood to the left of it against the north wall of the courtyard, and therefore the northern side of the alcove to entranceway WT(WK/BB)-b. This slab was probably inscribed with an abbreviated version of the SI.

23. Missing. Segment of the northern wall of WT and the slabs that faced it as far as the theoretical, reconstructed entrance to a corridor leading north toward the Northwest wing of the palace. For the reason why this wall has been placed here on the plan, see above the discussion of the group of four rooms, in section D.2, p. 45. The first slab to the right made the corner with the slab discussed s.v. no. 22, above. All the slabs were probably inscribed with the SI.

24. Missing. Entranceway to the corridor leading to the Northwest Wing. For this entranceway, made of two slabs inscribed with the SI, see above section D.2, p. 45, s.v. no. 2 and *Relief Representations II*, Plans 1.2.

25. Missing. Eastern segment of the northern wall of the courtyard, with its inscribed wall slabs. See *Relief Representations I*, Plans 1.2.

26. Missing. The western wall of the courtyard, with its inscribed wall slabs. For this wall, see above section D.1 p. 45 and *Relief Representations II*, Plans 1.2.

Supplements

Supplement 1

Catalogue of Relief Fragments at Nimrūd

91. The lion's paw. Part of the Lamassu ED-3 or ED-8. (ca. 0.15×0.35×0.35 m)

Supplement 2

Lamassu Sculptures (LL-Lions and LS-Bulls) belonging to the Official Part of the NW-Palace (cf. p. 52).

Supplement 3

Errata and Additions to the Placement of Reliefs discussed in *Reliefdarstellungen I* and *Relief Representations II*.

1. L-3,14 (?)

Bryn Athyn. SP 1550 (A-II-a-ii-18). (←); head and the upper part of the right shoulder of a winged, human-headed genius wearing a two-horned helmet, the horns of which are decorated with chevrons, as is the bottom of the helmet behind the ears, below the rope which holds the helmet and hair in place. A characteristic of the relief is the narrowness of the beard and the waviness of the hair and beard tresses. The wing feathers do not seem to have been completely cut into the relief, but only traced with the sculptor's point. The hair overlaps the shoulder.

This fragment was provisionally assigned to the West Wing (WFL-7). A reevaluation of that assignment was necessary after new photographs of other reliefs in room L were examined. The resemblance of this fragment to reliefs in room L seems so strong that we have decided to change our minds. A characteristic not clear to us before, that is also shared with the room L examples, is the double outline of the figure's horns. We therefore return to G. Markoe's original assignment, but are unable to decide in which of the two positions it actually belongs.

W 0.54 m; H 0.61 m

Bibliography: Stearns, *AfO-Bch.* 15, p. 22, pl. 30; Reade, *Iraq* 27, p. 131; Meuszyński, *AA* 1976, pp. 464–5, 479; Markoe, *Source* II, 4; Paley-Sobolewski, *Relief Representations II*, p. 75 (pl. 5, 24).

2. L-9(?)

Cincinnati 1952.7 (A-II-a-ii-6). (←); the head, right shoulder, portions of the wings and chest of a human-

headed, winged genius wearing a two-horned helmet, decorated with chevrons on the horns. The bottom of the helmet behind the ears and below the rope that holds helmet and hair in place, is decorated with chevrons. The surfaces of the face and helmet are eroded.

A new photograph and remeasurement of the piece has caused us to reconsider the placement of this piece of relief. It shares characteristics with room L reliefs which have recently been reexamined: the narrowness of the beard and waviness of the hair and beard tresses, the hair bob that overlaps the shoulder and a certain polished look and fineness to the relief as a whole and, despite eroded surfaces, to the face. The horns are decorated with chevrons and have a double outline. There is one vacant space for a left-facing genius in room L: L-9. We assign this fragment of a figure there.

W 0.86 m; H 0.86 m

Bibliography: Stearns, *AfO-Bch.* 15, p. 33, pl. 30; Meuszyński, *AA* 1976, pp. 400, 479; Paley-Sobolewski, *Relief Representations II*, p. 74, pl. 5,23.

The reassignment of the above two reliefs has effectively reduced group C of our West Wing one-register reliefs to two examples, WFL-9 and WFL-30, neither of which can be assigned to other West Wing groups because of preservation.

Our thanks to Dr. Glen Markoe of the Cincinnati Museum for providing new measurements and a photograph with which to work.

3. G-19.

A fragment of a relief, the head and shoulders of a left-facing genius with two-horned helmet (A-II-a-ii-17), assigned by Meuszyński to G-19 (*Reliefdarstellungen I*, p. 47, pl. 9,1; 10,3), formerly in a private collection in Santa Barbara, Ca. and Rockford, Illinois, then in the collection of Rockford College, was recently sold to a New York Private collector. Pictures of it appear on the cover and in the Sotheby catalogue, though somewhat cropped. See Sotheby's, *Antiquities and Islamic Art*, New York, Monday, November 24, 1986, cover and pp. 38–39.

Our thanks to Richard Keresey and Sotheby's, New York, for bringing this sale to our attention.

4. S-24. (W 0.57 m; H 0.51 m)

A fragment of a relief, the front part of a head of a left-facing genius with three-horned helmet (A-II-a-ii-type). The

head and helmet are of a type assigned to room S. The fragment can be attached to the rear part of a head of a genius in position S-24 *in situ* at Nimrūd, fitting exactly.

From a private collection in London and now in a private collection in New York. See Sotheby's, *Antiquities*, London, Monday 12th December 1988 at 11 AM and 2:30 PM, no. 54. The head fragment has been cleaned, during which time the fragment of beard attached to the old restoration was removed. Although it was claimed that the beard fragment did not belong to the head, this is not sure. The reliefs along this wall in room S were restored from large and small fragments, some as small as the beard fragment in question.

Our thanks to Samuel Merrin and The Merrin Gallery, New York, for bringing this sale to our attention and for providing photographs of the cleaned piece.

5. I (?). (W 0.73 m; H 0.78 m)

Los Angeles County Museum of Art M.71.73.1A. Winged, human-headed genius, wearing horned helmet, kneeling, hands outstretched. (→); on the right side of the relief part (ca. 1/3) of a Sacred Tree. The left edge of the relief is original. On the lower edge is preserved a portion of the first line of the Standard Inscription, as follows:

[É.GAL Aššur.PAP.A SANGA Aššur ni-sit ^aBEu]
^aMAŠ na-ra-am ^dA-nim...

This relief was unknown to us when we published a theoretical reconstruction of the decoration of room I (*Relief Representations* II, pp. 3ff.). In the scheme that we developed for room I, all the positions of right-facing genie from the left side of slabs were filled with relief fragments that we knew. This example will require a rethinking of our reconstruction, in the basic premise of which we still believe. Some detail must be changed in order to accommodate this example. Since we have not come to any conclusion as yet, this must wait for some further publication.

Bibliography: Berg, pp. 18–19, fig. 1.

The Los Angeles County Museum has three other fragments of Assyrian wall slabs, all sections of the Standard Inscription, from the middle bands of two-register reliefs or

from reliefs with only the Standard Inscription. They will be included among the exemplars in A. Kirk Grayson's *The Royal Inscriptions of Mesopotamia: Assyrian Periods*.

Our thanks to Nancy Thomas of the Los Angeles County Museum for providing photographs and other details concerning these fragments.

6.I-19 and I-21.

Research concerning the placement of relief fragments on the north wall of room I went through several revisions before final publication. The final text placed Nimrud 44, Vatican 19849 and Rochester 44.10 in the upper register of I-19 but the drawing shows Nimrud 44, Ottawa 2918 and Rochester 44.10. The text reflects the correct placement; the drawing of Vatican 19849 should be moved from I-21 to I-19 and that of Ottawa 2918 moved to I-21 in its place.

Bibliography: Paley-Sobolewski, *Relief Representations* II, pp. 19 and 21; Paley, "The Winged Genius", p. 9, n. 14.

7.G-25. (?)

Michigan, Kalamazoo Public Museum 60.253. Fragment of the lower part of the sheath of a sword of a figure facing (←). This is probably a missing piece of the king's sword from slab G-25, as suggested by J. Reade (private correspondence). There are cuneiform signs from two separate lines of text on the upper edge of the fragment. The signs are from the royal titulary, as follows:

X...*tab-ra*]-te [...

X+1...*a*]-*a-bi-šu* [...

(Paley *KW*, p. 126, IIc and IIe)

The sword sheath goes deeper into the area of the inscription than is shown on the published drawing of the fragments of the slab: the piece with the king's left arm and torso should be rotated clockwise to make the adjustment. This would improve the alignments of the inscription. See Meuszynski, *Reliefdarstellungen* I, pl. 9, 3.

Our thanks to Dr. Julian Reade, and to Ms. Paula Metzner for providing a photograph of the fragment in the Kalamazoo Public Museum.

*Supplement 4:
Catalogue of Reliefs in Collections Outside Nimrūd*

No.	Collection and Registration No.	Stearns' Classification or Short Description	Position of Slab	Found on:		In the text on page/s/:
				Plan	Plate, Drawing	
315	Los Angeles County Museum of Art 71.73.1A	B-II-e-i type genius	I /?/ or West Wing	—	—	50
316	Shelby White-Leon Levy Collection (ex.Bryn Athyn)	A-II-a-i type genius	ED-5 /?/	—	—	49
317	Shelby White-Leon Levy Collection (ex.Bryn Athyn)	A-II-a-ii type genius	ED-6 /?/	—	—	19f., 49
318	Sotheby, Catalogue 1988 (private Collection)	Front part of a head of genius type A-II-a-ii	S-24	—	—	19f., 49f.
319	Kalamazoo Public Museum 60.253	Fragment of a sword's scabbard (royal)	G-25 /?/	—	—	50

Supplement 2: Lamassu Sculptures (LL - Lions and LS - Bulls)

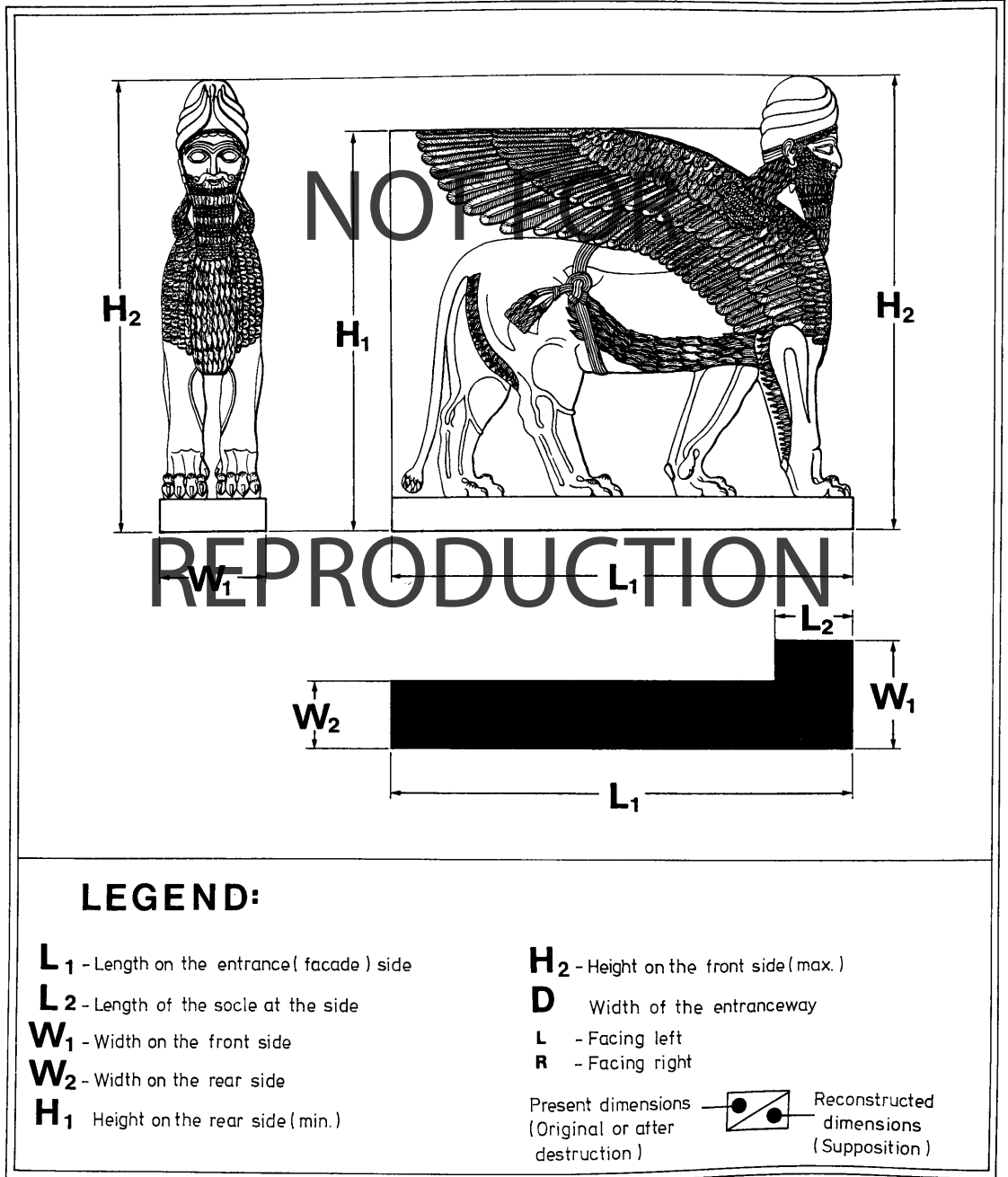

belonging to the Official Part of the NW - Palace

No	Representation	Facing	Position in NW-Palace	In Collections, In Situ, Reconstruction	Dimensions in Metres							In Text on Page/s/	Found on:			Remarks
					L ₁	W ₁	W ₂	L ₂	H ₁	H ₂	D		Plate	Photogr.	Plan	
1	Lion	R	B-a-1	London, B.M.118801	3,63	0,85	0,39	0,59	3,08	3,50	4,00(?)	26, 29, 30	5.1	—	1	Measurements by J.Reade.
2	Lion	L	B-a-2	London, B.M.118802	3,71	0,81	0,48	0,68	3,08	3,50		26, 29, 30	5.1	—	1	
3	Bull	R	B-b-1	Baghdad, IM 26472 Lond., B.M.118894	2,56	0,55	0,47	0,44	2,45	2,20	2,26(?)	26, 29, 31	5.2	—	1	Measurements by N.Postgate and J.Reade.
4	Bull	L	B-b-2	Baghdad, IM 26473	2,59	0,49	0,42	0,45	2,40	2,79		26, 29, 30	5.2	—	1	
5	Lion	L	D-d-1	Nimrud	3,70	0,72	0,43	0,70	3,00	3,25	2,10	3, 6, 15	1.1; 4.1 4.5	1	1	
6	Lion	R	D-d-2	Nimrud	3,71	0,76	0,46	0,64	3,00	3,25		3, 6, 15	1.1; 4.1	2	1	
7	Lion	L	E-c-1	Nimrud	3,62	0,76	0,49	0,69	3,10	3,30	1,89	3, 6, 24	1.2; 4.1	3,5	1	
8	Lion	R	E-c-2	Nimrud	3,62	0,78	0,52	0,70	2,20	3,20		3, 6, 23	1.2; 4.1 4.2	4,5	1	
9	Bull	L	ED-1(façade)	Nimrud	4,94	0,85	0,47	0,96	4,50	4,80	—	22	3.1; 4.1 4.2	5,6	1	A reconstruction corresponding to the shape of the sculptures in B-a.
10	Lion	R	ED-3(façade)	Reconstruction	—	—	—	—	—	—	—	21	3.1; 4.1	—	1	
11	Lion	L	ED-8(façade)	Reconstruction	—	—	—	—	—	—	—	20	3.2; 4.1 4.4	—	1	
12	Bull	R	ED-10(façade)	Nimrud and Reconstruction	4,94	0,80	0,47	0,80	4,50	4,80	—	17	3.2; 4.1 4.5	7	1	The reconstructed width of entranceway "e" is based on the measurements of the doorsill slabs of the tallest and main entrance of the palace.
13	Bull	L	ED-e-1	Reconstruction	—	—	—	—	—	—	—	21	2.1; 4.1 4.3	—	1	
14	Bull	R	ED-e-2	Reconstruction	—	—	—	—	—	—	—	21	2.1; 4.1 4.3	—	1	
15	Bull	R	F-f-1	Nimrud	3,58	0,64	0,54	0,54	1,80	2,75	2,18	32, 38	6.1	8.10	2	The upper parts of both sculptures are partly destroyed. Original heights are reconstructed.
16	Bull	L	F-f-2	Nimrud	3,31	0,58	0,45	0,27	2,85	1,60		32, 38f.	6.1	9.10	2	
17	Lion	L	G-b-1	N.York, MMA321432	2,76	0,61	0,31	0,55	2,95	3,34	2,02(?)	32, 37	6.2	—	2	Measurements by H.Pittman.
18	Lion	R	G-b-2	London, B.M.118873	2,81	0,62	0,39	0,55	2,91	3,28		32, 37	6.2	—	2	
19	Bull	L	S-e-1	London, B.M.118872	3,14	0,60	0,31	0,60	2,89	3,10	2,20(?)	32, 42	7.1	—	2	Measurements by H.Pittman.
20	Bull	R	S-e-2	N.York, MMA321431	3,10	0,61	0,20	0,53	2,89	3,09		32, 42	7.1	—	2	
21	Lion	R	WG-g-1	Reconstruction	—	—	—	—	—	—	2,20(?)	32, 40	7.2	—	2	A reconstruction corresponding to the sculptures of the entrance G-b.
22	Lion	L	WG-g-2	Reconstruction	—	—	—	—	—	—		32, 40	7.2	—	2	
23	Lion	R	WK-a-1	Nimrud and Reconstruction	—	—	—	—	1,20	1,28	1,60(?)	44, 46	8.1	—	3	After Layard's notes - not yet reexcavated. The width of the entranceway is as WK-d (symmetry).
24	Lion	L	WK-a-2	Nimrud and Reconstruction	—	—	—	—	1,20	1,28		44, 47	8.1	—	3	
25	Lion	R	WK-d-1	Reconstruction	—	—	—	—	—	—	1,60(?)	47	—	—	3	A reconstruction corresponding to the decoration of entrance WK-a. The width of the passage between the mud-brick walls was restored by the Iraqi mission.
26	Lion	L	WK-d-2	Reconstruction	—	—	—	—	—	—		47	—	—	3	
27	Bull	R	WK-e-1	Reconstruction	—	—	—	—	—	—	2,30(?)	47	—	—	3	Assigning the doorsill slabs of the so-called "Second House" to passageway WK-e, determines its width.
28	Bull	L	WK-e-2	Reconstruction	—	—	—	—	—	—		47	—	—	3	

List of Figures, Plates and Plans

FIGURES

Fig. 1. The front part of the Lamassu-lion (1) forming the decoration of the eastern side of passageway D-d. To the left, relief D-3

Fig. 2. The front part of the Lamassu-lion (2) decorating the western side of passageway D-d. To the right, two courtiers of the relief D-4

Fig. 3. Lamassu-lion (1) of the eastern side of entrance E-c. To the left, the lower parts of two reliefs: E-1 and E-2

Fig. 4. Lamassu-lion (2) of the western side of entrance E-c. To the right, the fragments of two reliefs: E-3 and E-4

Fig. 5. A perspective view of entrance E-c, leading to throneroom B. From the left: two Lamassu-lions (1 and 2), a fragment of the slab E-5 (four-winged genius) and a front part of the gigantic Lamassu-bull (ED-1)

Fig. 6. Lamassu-bull (ED-1) decorating the eastern side of the southern façade of main courtyard ED

Fig. 7. Fragmentary preserved Lamassu-bull (ED-10) decorating the western side of the southern façade of main courtyard ED. To the right, the four-winged genius D-1

Fig. 8. Lamassu-bull (1) of the eastern side of passageway "f", joining room F with courtyard Y. To the right, unsculptured inscribed slabs belonging to the southern courtyard façade (Y-42.41.40)

Fig. 9. Lamassu-bull (2) of the western side of passageway "f". To the left, two inscribed slabs: Y-43.44

Fig. 10. The middle part of the northern façade of courtyard Y. Entrance "f" with two sculptures of bulls. The arch over it is modern work

Fig. 11. A fragment of a lion's paw, belonging to the gigantic statue of the Lamassu which decorated the southern façade of main courtyard ED, (ED-3 or ED-8)

Plates

The Outer Façade of the Throneroom

1.1 Entrance D-d (D-d-1.D-d-2). Scale 1:40

1.2 Entrance E-c (E-c-1.E-c-2). Scale 1:40

2.1 Entrance ED-e (ED-e-2.ED-e-1). Scale 1:40

3.1 Eastern part of the façade (ED-1.ED-2.ED-3). Scale 1:40

3.2 Western part of the façade (ED-8.ED-9.ED-10). Scale 1:40

4.1 General view of the outer façade of the Throneroom. (E-1.E-2.E-c-1.entrance E-c.E-c-2.E-3.E-4.ED-1.ED-2.ED-3.ED-e-1.entrance ED-e.ED-e-2.ED-8.ED-9.ED-

10.D-2.D-3.D-d-1.entrance D-d.D-d-2.D-4.D-5.D-6.D-7.D-8.D-9). Scale 1:50

4.2 Western side of passageway E-c (E-c-2.E-5.ED-1). Scale 1:50

4.3 Reconstruction of the main entrance ED-e. Three-registered narrow reliefs on both sides of the front parts of the gigantic Lamassu-bulls decorating entranceway "e". Scale 1:50

4.4 Western side of passageway ED-e (ED-e-2.ED-7.ED-8). Scale 1:50

4.5 Eastern side of passageway D-d (ED-10.D-1.D-d-1). Scale 1:50

Room B

5.1 Entrance B-a (B-a-2.B-a-1). Scale 1:40

5.2 Entrance B-b (B-b-2.B-b-1). Scale 1:40

6.2 Entrance G-b (G-b-1.G-b-2). Scale 1:40

7.1 Entrance S-e (S-e-1.S-e-2). Scale 1:40

7.2 Entrance WG-g (WG-g-1.WG-g-2). Scale 1:40

Courtyard Y

6.1 Entrance F-f (F-f-2.F-f-1). Scale 1:40

Courtyard WT

8.1 Entrance WK-a (WK-a-1.WK-a-2). Scale 1:40

Plans

1. Plan of the northern area of the official part of the NW-Palace. Rooms: B.C.D.E.ED. Scale 1:100
2. Plan of the inner Courtyard Y with the passageways leading to the neighbouring rooms: F.G.P.S.Z and WG. Scale 1:100
3. Plan of the western area of the West Wing. Room WK/BB with outer Courtyard WT (the reconstruction). Scale 1:100
4. The doorsill slabs of main entrance ED-e leading from courtyard ED to Throneroom B. Scale 1:40
5. The doorsill slabs of the so-called "Second House", probably belonging to passageway WK-e joining outer Courtyard WT with room WK/BB. Scale 1:40

Index

- Additions and Errata to Reliefdarstellungen I and Relief Representations II (see Supplement 3, pp. 49 ff.); G-24.25 (?) (p. 49f.); I-3.14.19.21 (p. 49f.). I (or West Wing) (p. 50); L-3.9.14 (p. 49); S-24 (p. 49)
- Altar Inscription (Bull-Lion)– fragments with transliteration; (B) D-d-1.2 (p. 15f.); ED-1 (p. 22); ED-10 (p. 17); (B) E-c-1.2 (p. 23f.); B-a-1.2 (p. 30); (F) B-b-1.2 (p. 30f.); Y (G)-b-1.2 (p. 37); Y (F)-f-1.2 (p. 38f.); Y (S)-e-1.2 (p. 42); WT (WK/BB)-a-1 (p. 46)
- Animal (attribute); D-d-1.2 (p. 15); ED-1.2.9.10 (pp. 17ff.)
- Animal (other representation); Monkey: D-7 (p. 13f.)
- Annalistic Inscription – fragments with transliteration; Threshold and Pavement – entrance (B) E-c (p. 23f.)
- Arm (attribute); D-2.3 (p. 16)
- Attributes; see: animal, arm, bucket, cone, diadem, fish, plant, sword
- Bucket (attribute); D-1 (p. 16f.); E-5 (p. 22); ED-4.5.6.7 (p. 20f.)
- Cone (attribute); D-1 (p. 16f.); E-5 (p. 22); ED-4.5.6.7 (p. 20f.)
- Courtier; D-2.3.4 (pp. 14.16)
- Diadem; ED-2.9 (p. 20f.)
- Entrances decorated with Lamassu-Bulls; B-b (p. 30f.); ED-e (p. 21); F-f (p. 38); S-e (p. 42); WK-e (p. 47); See also Supplement 2 (p. 52)
- Entrances decorated with Lamassu-Lions; B-a (p. 30); D-d (p. 15); E-c (p. 23f.); G-b (p. 37); WG-g (p. 40); WK-a.d (p. 46ff.); See also Supplement 2 (p. 52)
- Entrances decorated with reliefs; Y (S)-a (p. 42f.). Y (Z 10 and Z 5) (p. 41). Y (WG)-d (p. 41). Y (WG)-h (p. 40); WK-b (p. 48). WK-c.g (Plan 3)
- Eunuch; see Courtier
- Fish (attribute); ED-1 (p. 22); ED-10 (p. 17)
- Genius (G), winged, human-headed, kneeling (hands outstretched); Type B: I (or West Wing)- See Supplement 3 (p. 50)
- Genius (G), winged (two wings), eagle-headed, standing (with cone and bucket); Type B or C: ED-5.6 (p. 20f.)
- Genius (G), winged (two wings), human-headed, standing (with cone and bucket); Type B or C: ED-5.6 (p. 20f.)
- Genius (G), winged (two wings), human-headed, standing (with plant); Type B or C: ED-5.6 (p. 20f.)
- Genius (G), winged (four wings), human-headed, standing (with animal and plant); Type A: ED-2.9 (p. 20f.)
- Genius (G), winged (four wings), human-headed, standing (with cone and bucket); Type A: D-1 (p. 16); ED-4.7 (p. 20f.); E-5 (p. 22)
- Helmet (one-horned); B-b-1.2 (p. 30f.)
- Helmet (two-horned); D-d-1.2 (p. 15); E-c-1.2 (p. 23f.); WK-a-1.2 (p. 46f.)
- Helmet (three-horned); B-a-1.2 (p. 30); D-1 (p. 16); E-5 (p. 22); ED-1.3.4.7.8.10 (p. 17ff.); ED-e-1.2 (p. 21); F-f-1.2 (p. 38); G-b-1.2 (p. 37); S-e-1.2 (p. 42); WG-g-1.2 (p. 40)
- Inscription – fragments with transliterations; See: Altar Inscriptions (Lion-Bull), Annalistic Inscriptions and Standard Inscriptions
- King (K); D-2 (p. 16)
- Lamassu-Bulls (LS); B-b-1.2 (p. 30f.); ED-1.10 (pp. 22.17); ED-e-1.2 (p. 21); F-f-1.2 (p. 42); WK-e-1.2 (p. 47); See also Supplement 2 (p. 52)
- Lamassu-Lions (LL) – (human-headed); B-a-1.2 (p. 30); ED-3.8 (p. 20f.); G-b-1.2 (p. 37); WG-g-1.2 (p. 40); See also Supplement 2 (p. 52)
- Lamassu-Lions (LL) – (with human torso); D-d-1.2 (p. 15); E-c-1.2 (p. 23f.); WK-a-1.2 (p. 46f.). WK-d-1.2 (p. 47); See also Supplement 2 (p. 52)
- Nimrud-fragments; See Supplement 1 (p. 49)
- Plant (attribute); D-d-1.2 (p. 15); ED-2.9 (p. 20f.). ED-5.6 (p. 20f.)
- Reliefs and Sculptures outside Nimrud (a continuous list); See Supplement 4 (p. 51), also in: Reliefdarstellungen I, Nachtrag Nr. 2 pp. 81 ff. and Relief Representations II, Supplement 5, pp. 88 ff.
- Sacred Tree (ST)-Type VIII; Type B: I (or West Wing); see Supplement 3 (p. 50)
- Slabs with one-registered reliefs (Type A); D-(1–9) (p. 13ff.); E-(1–5) (p. 22ff.); ED-2.4.7.9 (p. 20f.); Y (S)-a (p. 42f.); Y-(Z-10 and Z-5) (p. 41); Y (G)-c

- (p. 36f.); Y (WG)-d (p. 41); Y-(WG)-h (p. 40); WK (WT)-b (p. 48); WK (Z)-g (Plan 3); WK (WH)-c (Plan 3)
- Slabs with two-registered reliefs (Type B) or three-registered reliefs (Type C); ED-5.6 (p. 20f.)
- Slabs with Standard Inscription, only (I); (B) D-d-3.4 (p. 15); (B) E-c-3.4 (p. 24); (F) B-b-3.4 (p. 31); Y-1.5.6.9-17.28.29.34-47.52-70.74 (pp. 36ff); WK-a-3.4 (p. 47); WK-b-3.4 (p. 48); WK-c-3.4 (Plan 3); WK-d-3.4 (p. 47)
- Standard Inscription (SI) – fragments with transliteration:
- D-1 (p. 17). 3 (p. 16). 4 (p. 15). 5 (p. 14). 6 (p. 14). 7 (p. 14). 8 (p. 13). 9 (p. 13); E-3.4.5 (p. 22f.); ED-e (Threshold and Door-posts) (p. 21); G-25 (?) (p. 50); I (or West Wing) (p. 50); Y (P)-1 (p. 36). Y-6.7 (p. 36). 9–13 (p. 36). 28.29 (p. 37). 34–47 (pp. 37ff.) 53–55 (p. 39f.). 60.61 (p. 40f.). 65–70 (p. 41). 74 (p. 41)
- Sword (attribute); D-2.3 (p. 16)
- Threshold, entrances: E-c (p. 23); ED-e (p. 21); WK-e (p. 47)
- Tribute bearers; D-(5–9) (pp. 13ff.); E-(1–4) (pp. 22ff.)

Figures 1–11

Plates 1–8

Plans 1–5

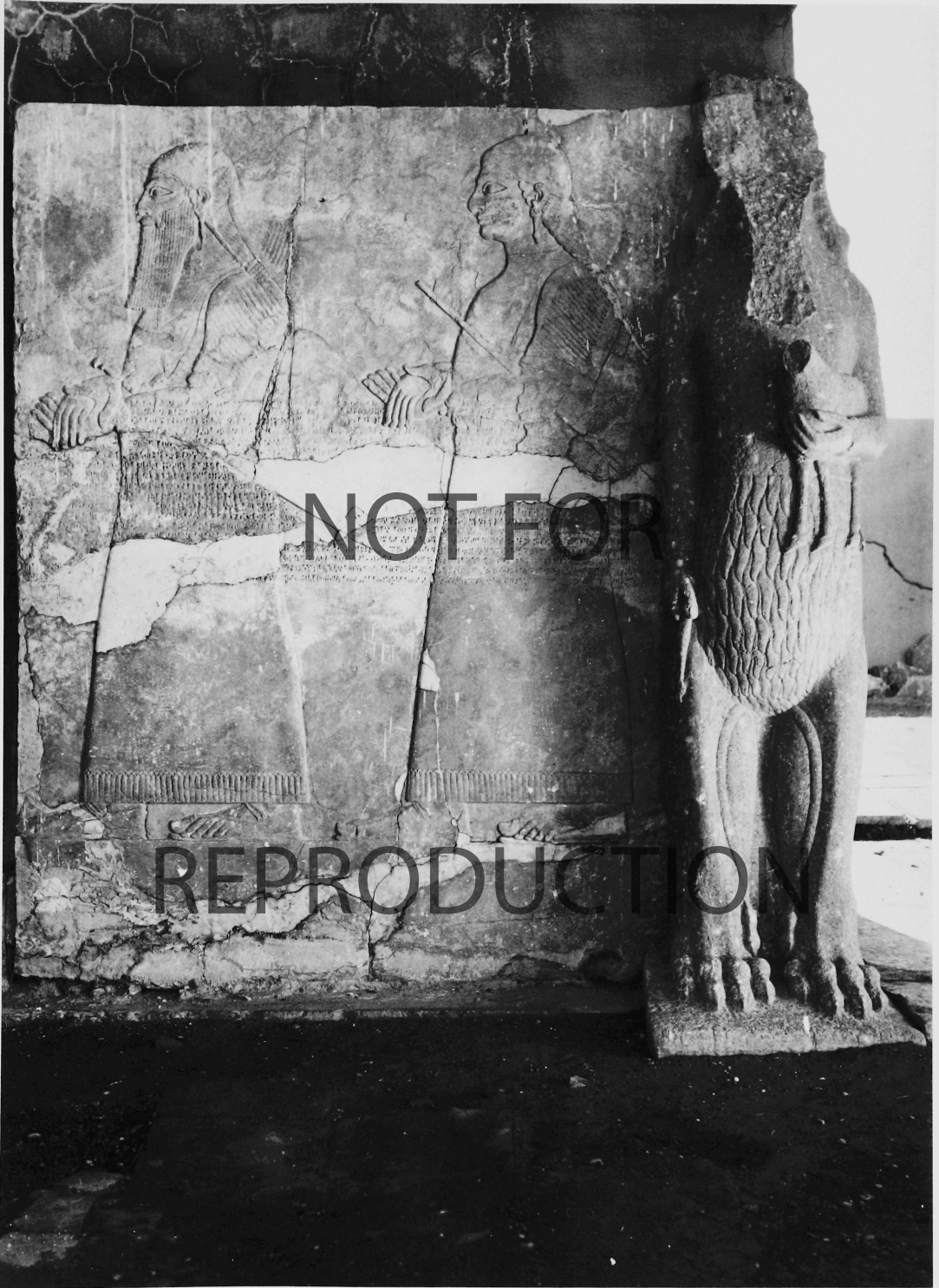

The front part of the Lamassu-lion (1) forming the decoration of the eastern side of passageway D-d. To the left, relief D-3

FIG. 2

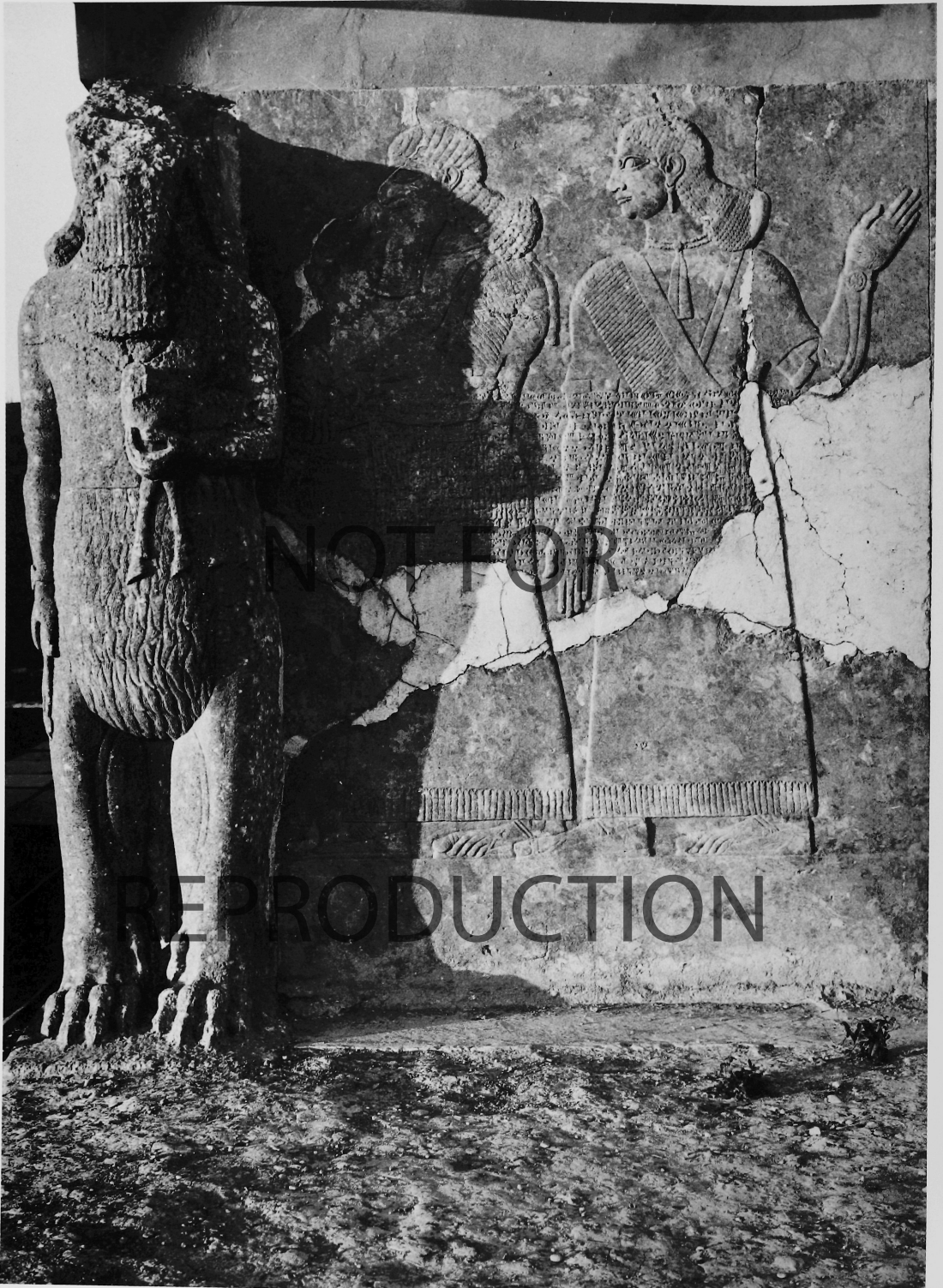

The front part of the Lamassu-lion (2) decorating the western side of passageway D-d. To the right, two courtiers of the relief D-4



Lamassu-lion (1) of the eastern side of entrance E-c. To the left, the lower parts of two reliefs: E-1 and E-2

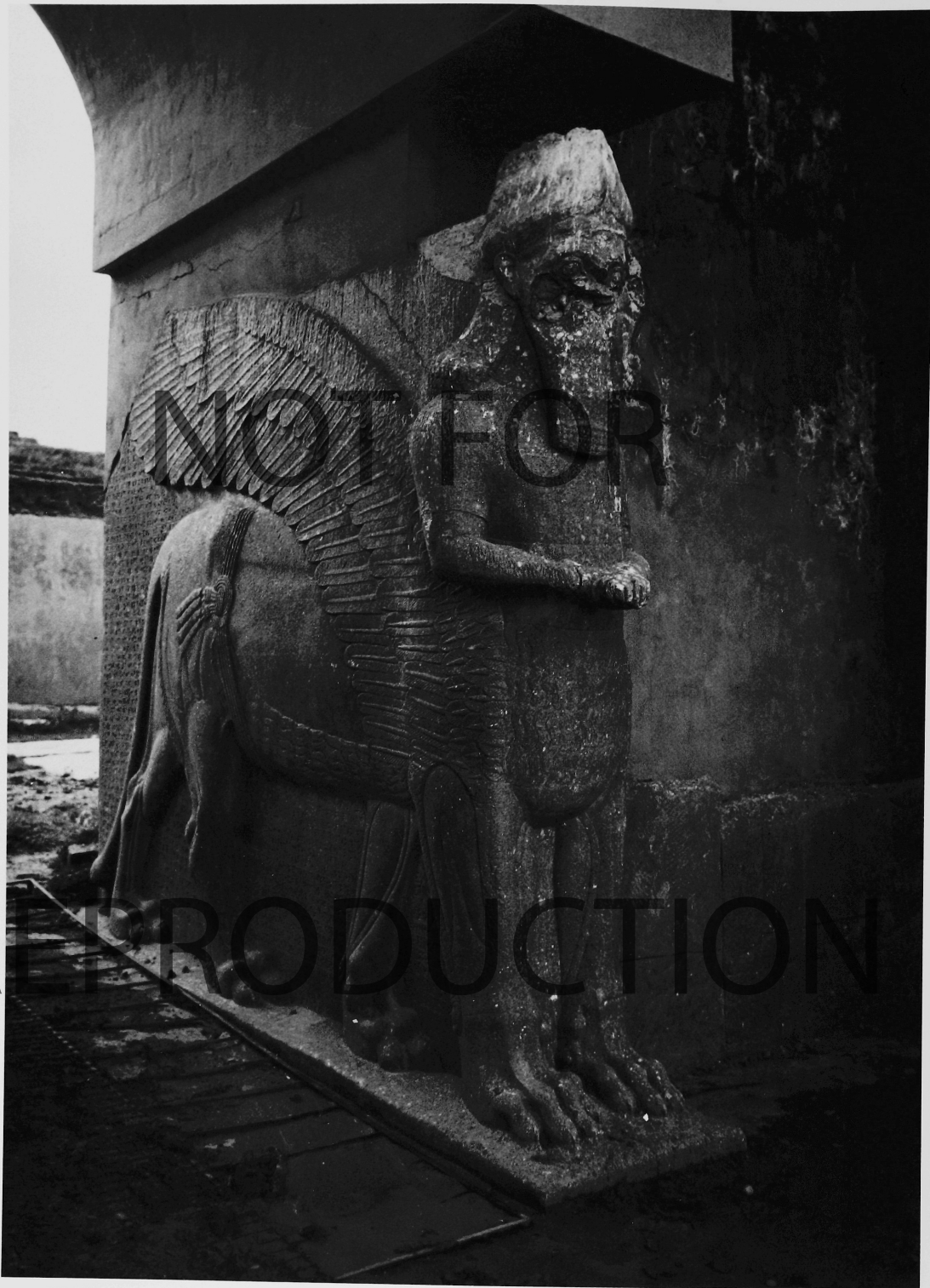

Lamassu-lion (2) of the western side of entrance E-c. To the right, the fragments of two reliefs: E-3 and E-4

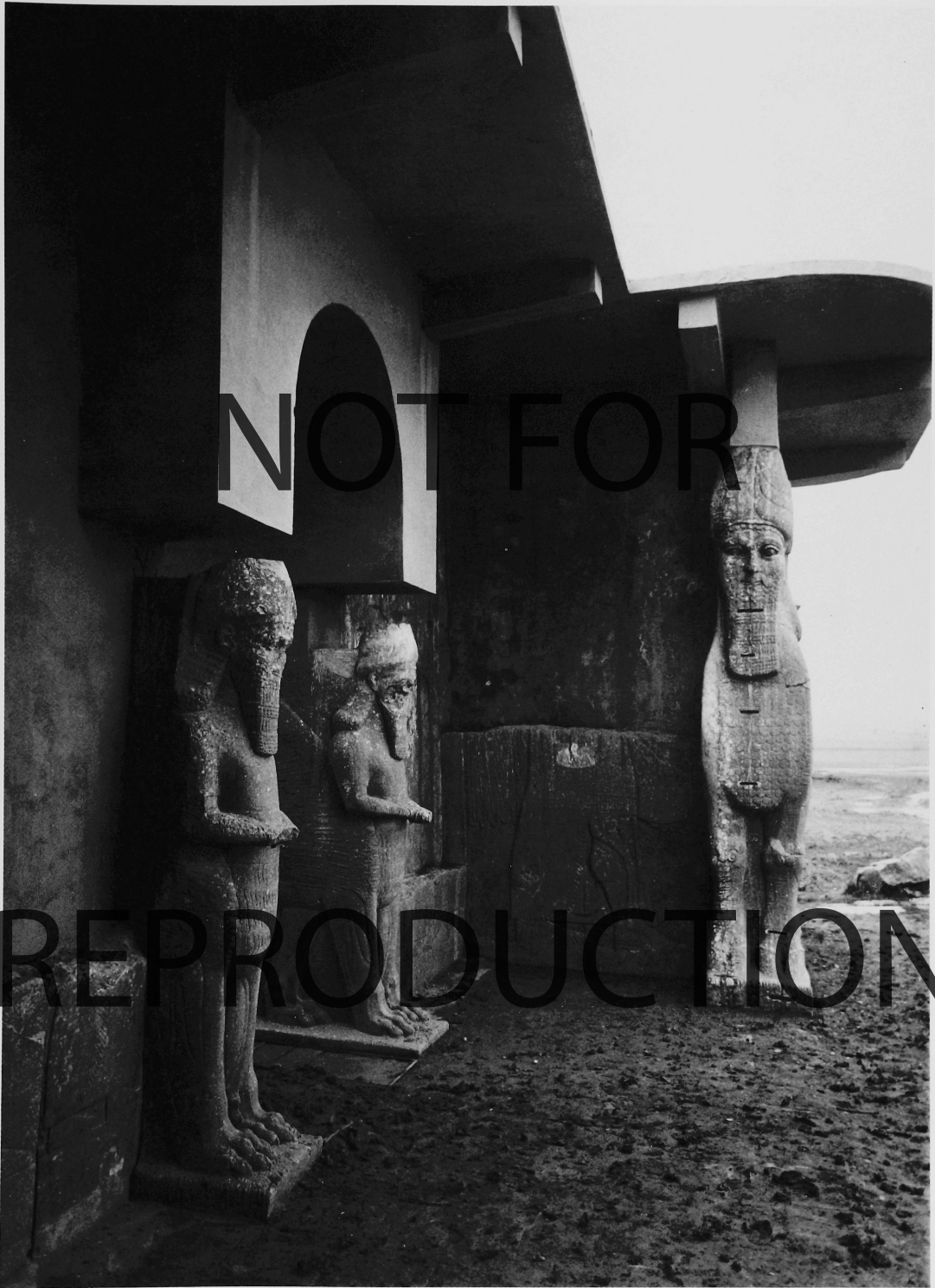

A perspective view of entrance E-c, leading to throneroom B. From the left: two Lamassu-lions (1 and 2), a fragment of the slab E-5 (four-winged genius) and a front part of the gigantic Lamassu-bull (ED-1)

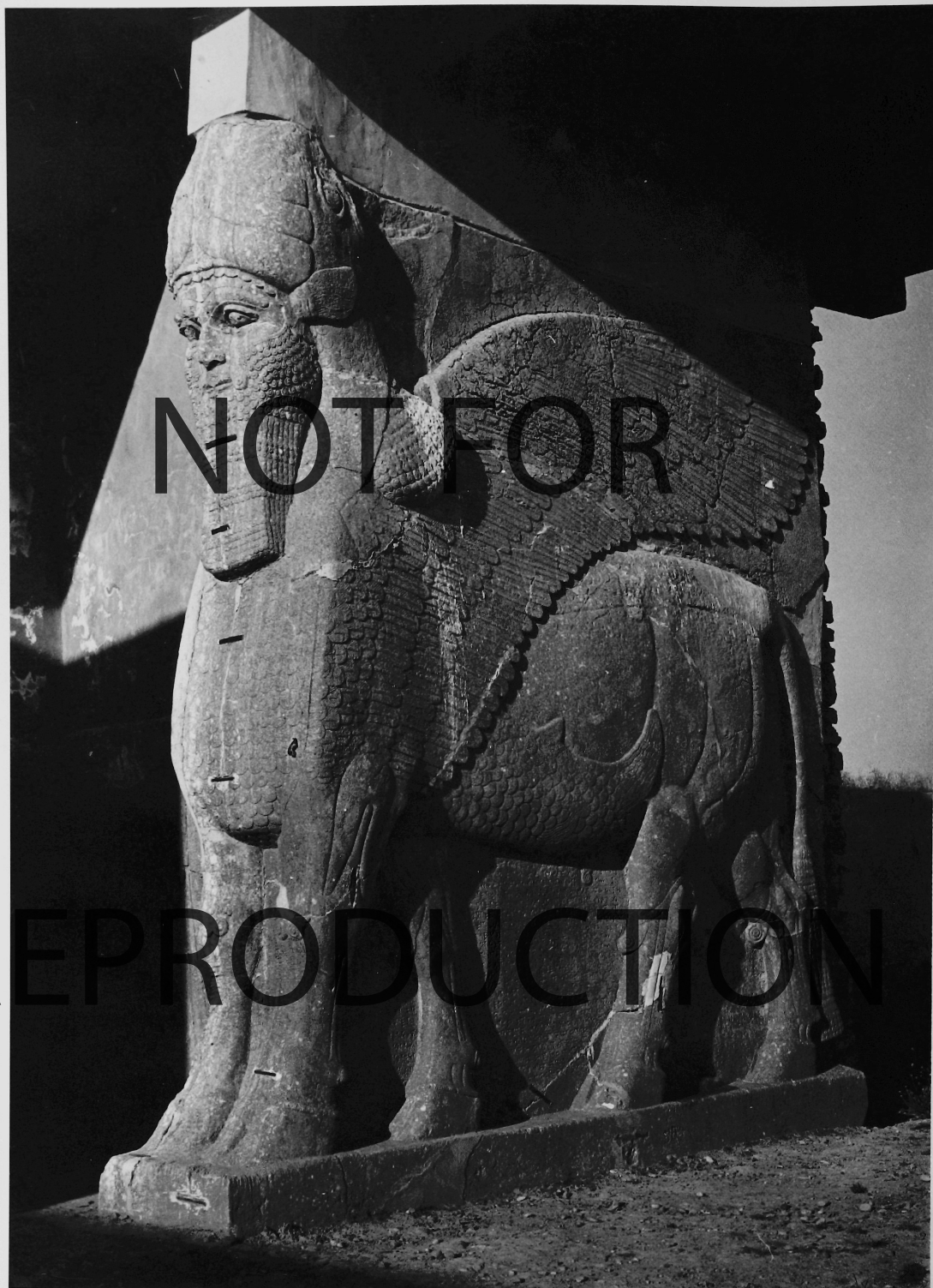

Lamassu-bull (ED-1) decorating the eastern side of the southern façade of main courtyard ED



Fragmentary preserved Lamassu-bull (ED-10) decorating the western side of the southern façade of main courtyard ED. To the right, the four-winged genius D-1

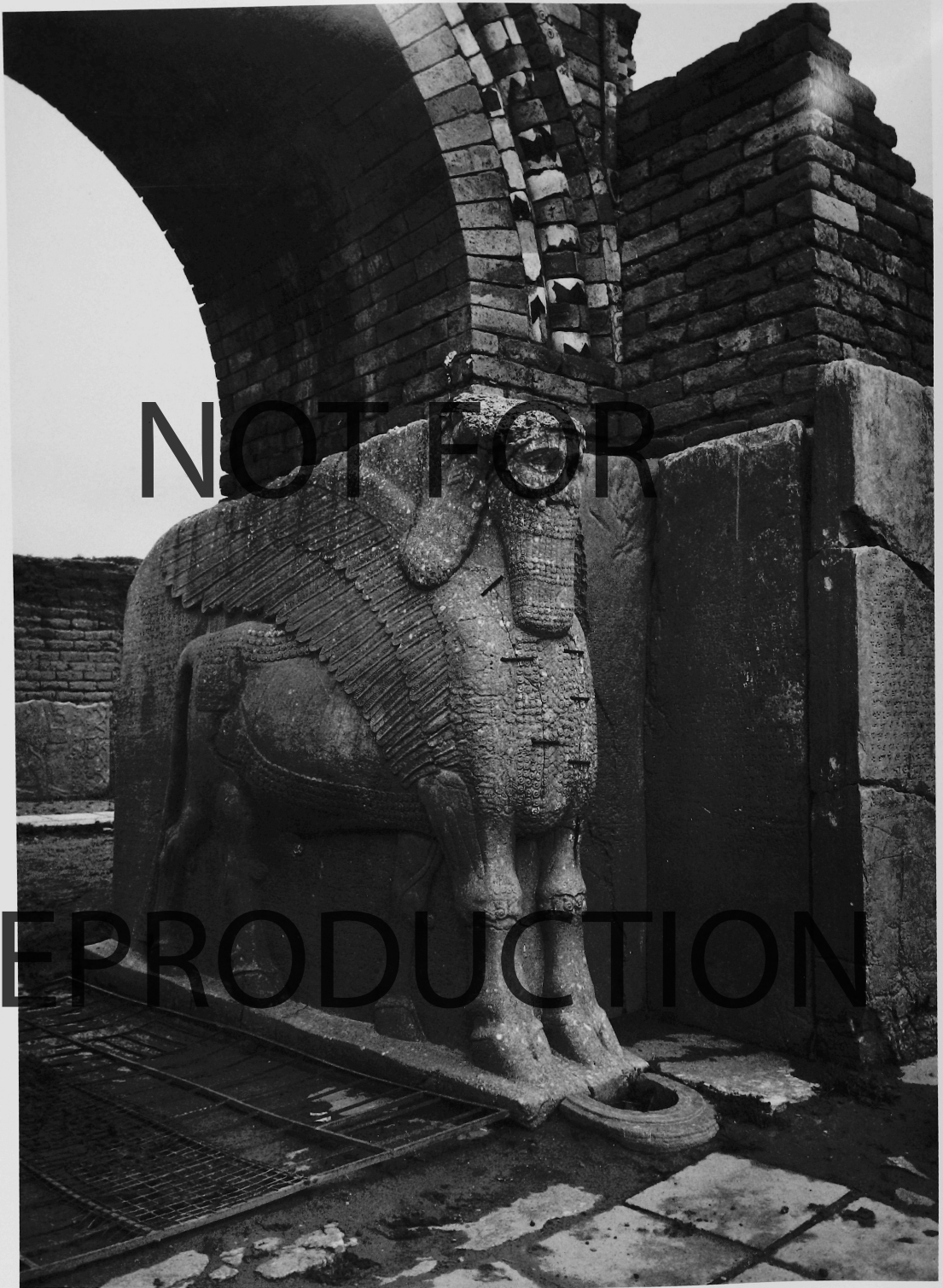

Lamassu-bull (1) of the eastern side of passageway "f", joining room F with courtyard Y. To the right, unsculptured inscribed slabs belonging to the southern courtyard façade (Y-42.41.40)

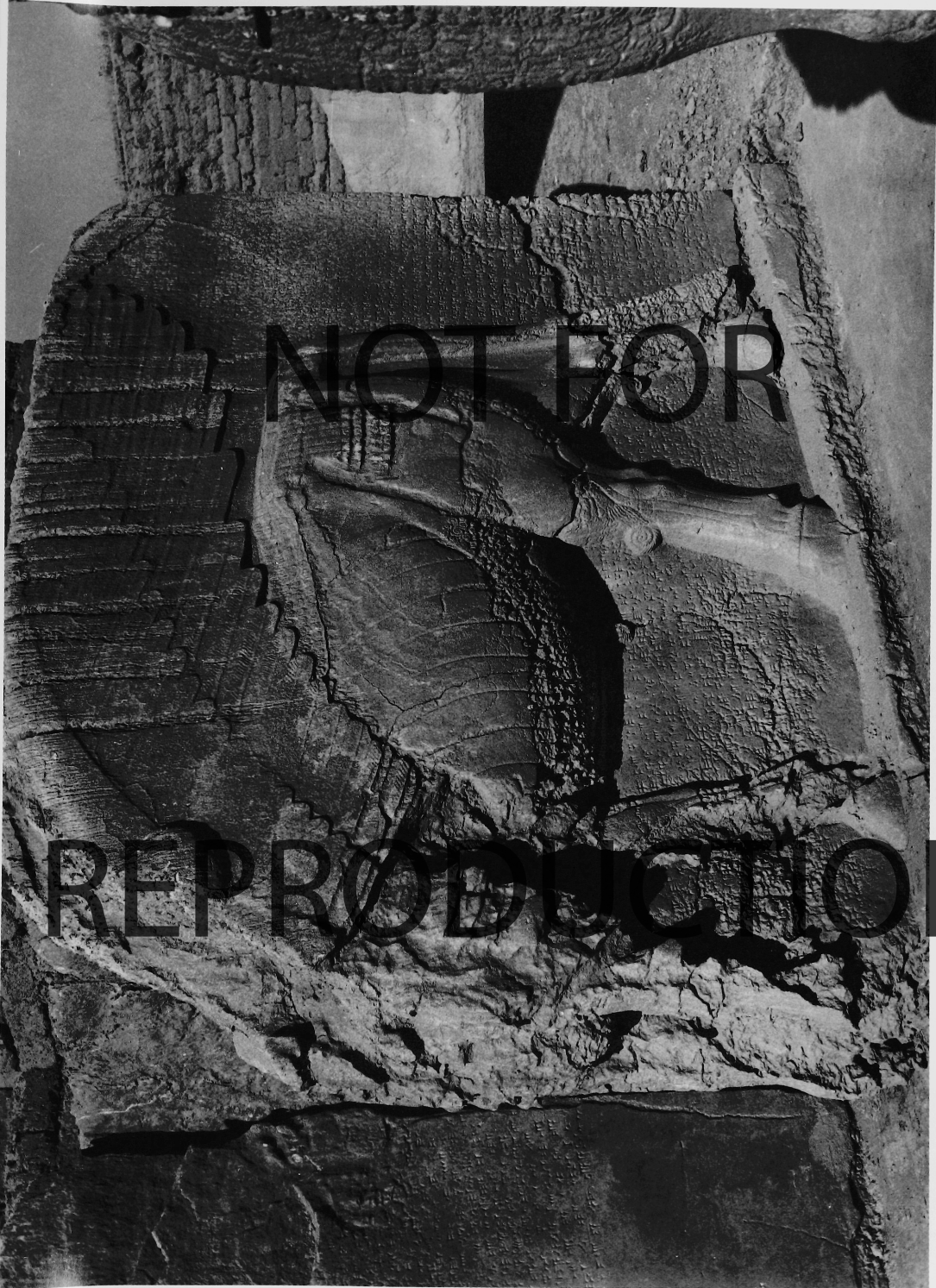

Lamassu-bull (cf. of western side of passageway "f"). To the left, two inscribed slabs: Y-43.44

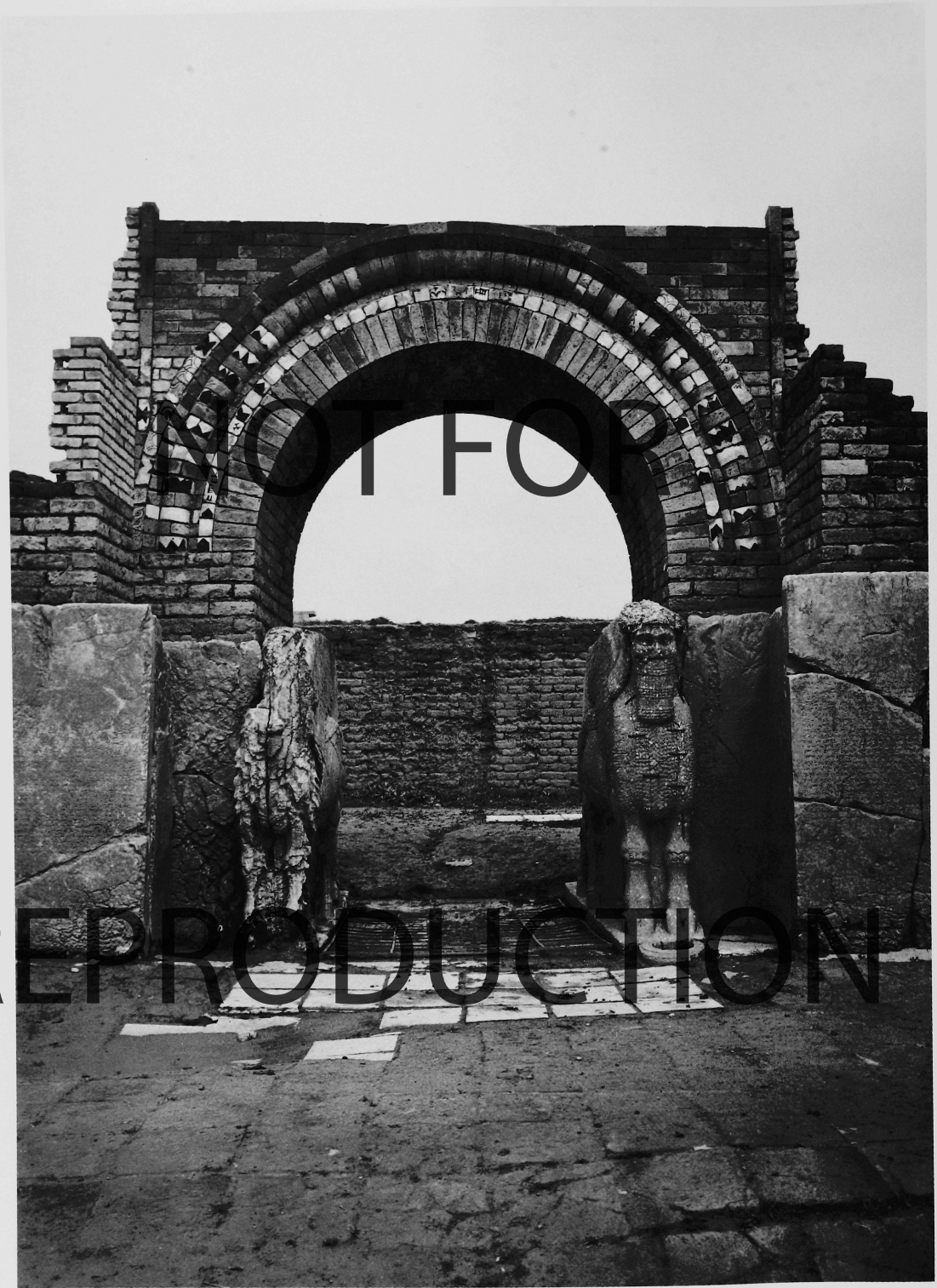

The middle part of the northern façade of courtyard Y. Entrance "f" with two sculptures of bulls. The arch over it is modern work

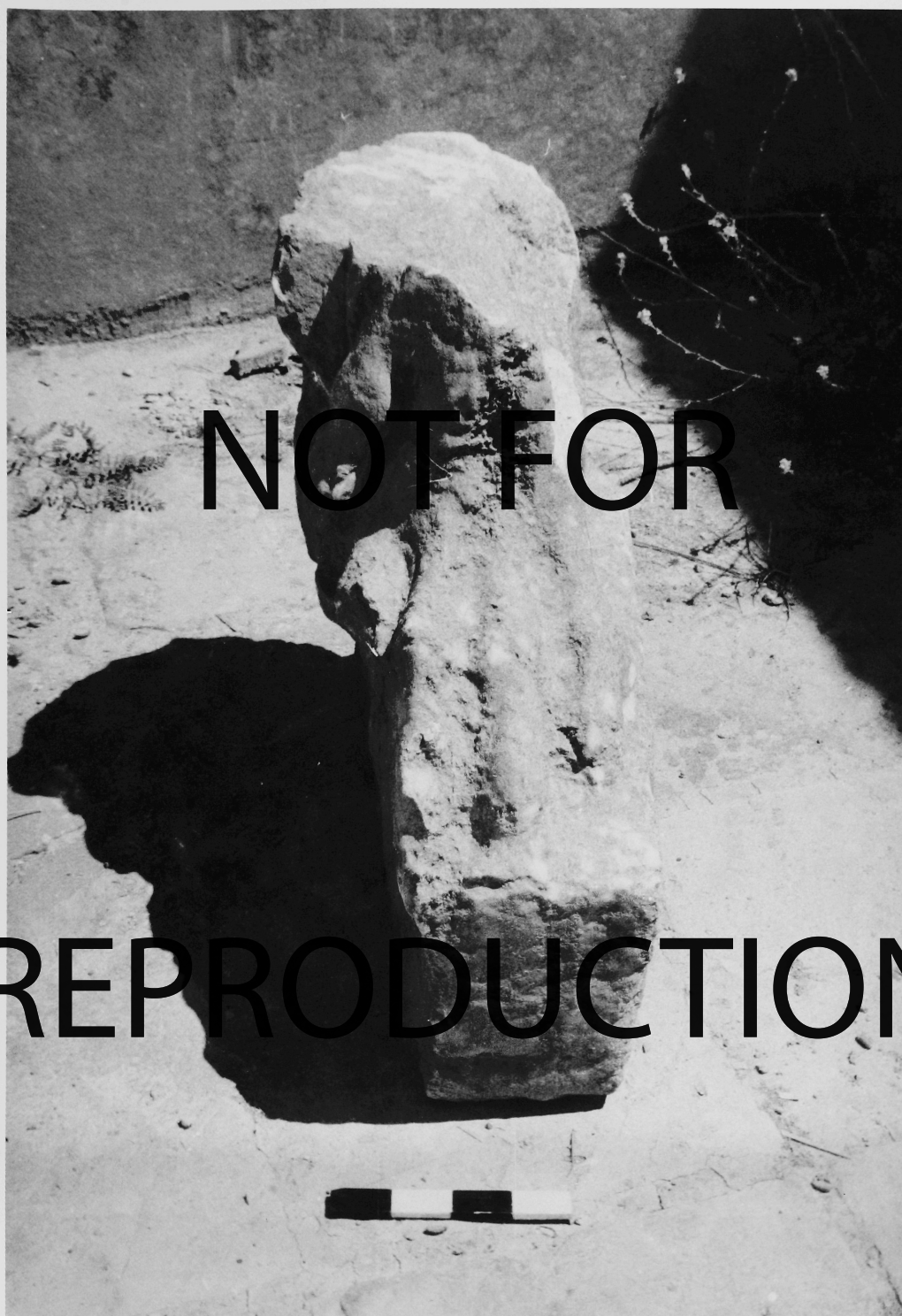

A fragment of a lion's paw, belonging to the gigantic statue of the Lamassu which decorated the southern façade of main courtyard ED (ED-3 or ED-8)

NOT FOR

NOT FOR

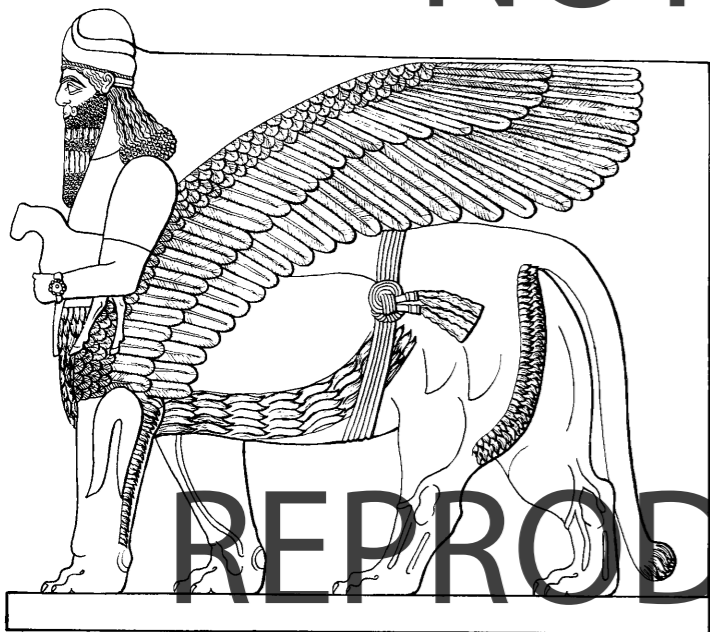

„d”

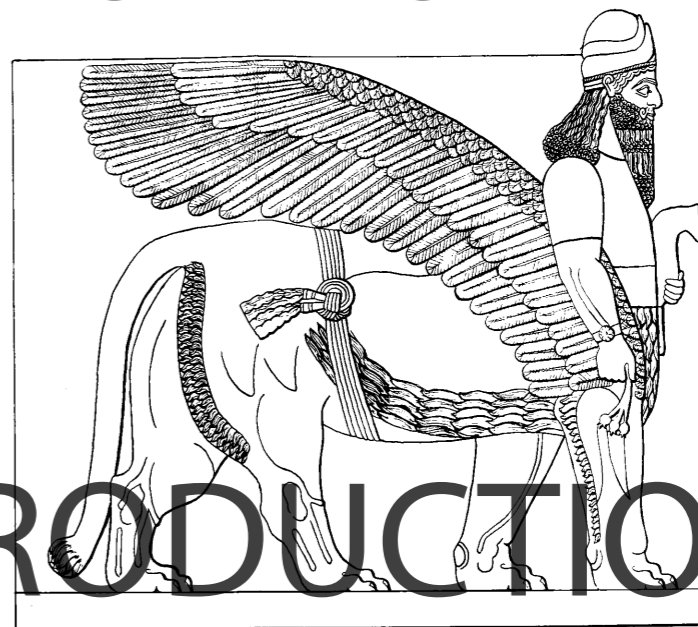
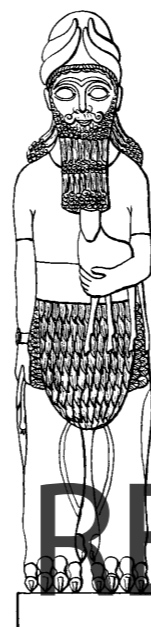

D-d-1

D-d-1

D-d-2

D-d-2

1.1 Entrance D-d (D-d-1,D-d-2). Scale 1:40

NOT FOR

NOT FOR

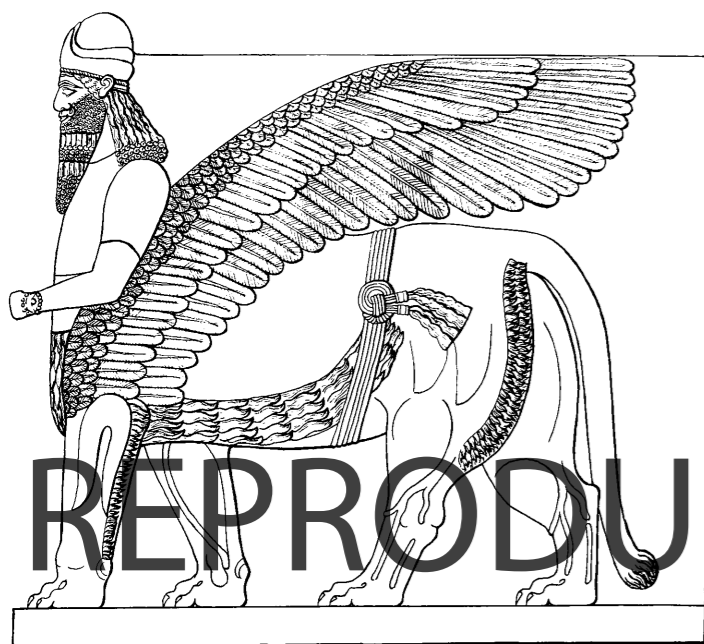

„C”

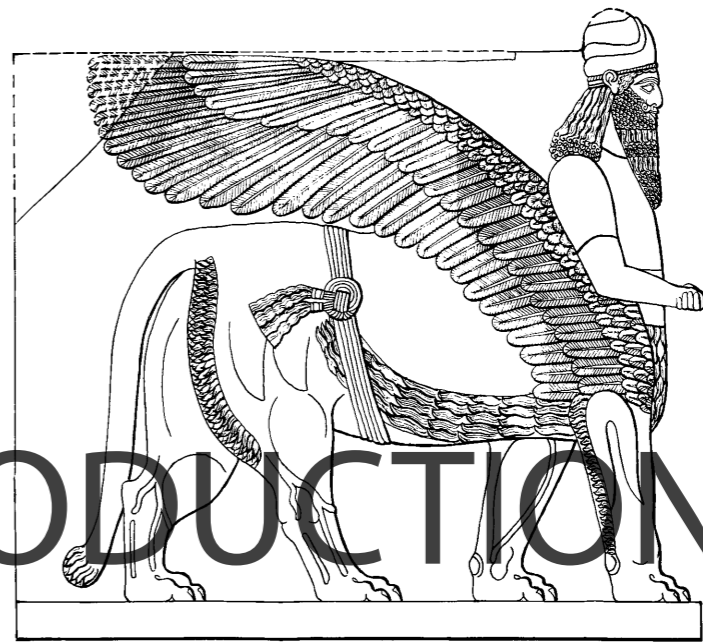

REPRODUCTION

REPRODUCTION

E-c-1

E-c-2

E-c-2

1.2 Entrance E-c (E-c-1,E-c-2). Scale 1:40

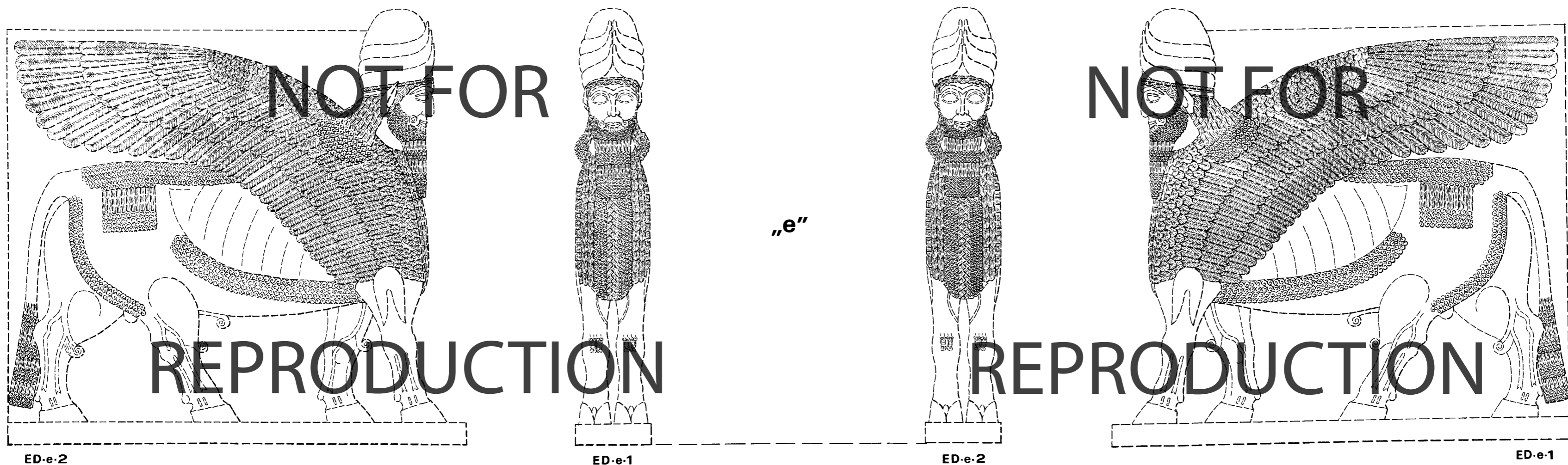

ED-e-2

ED-e-1

ED-e-2

ED-e-1

2.1 Entrance ED-e (ED-e-2.ED-e-1). Scale 1:40

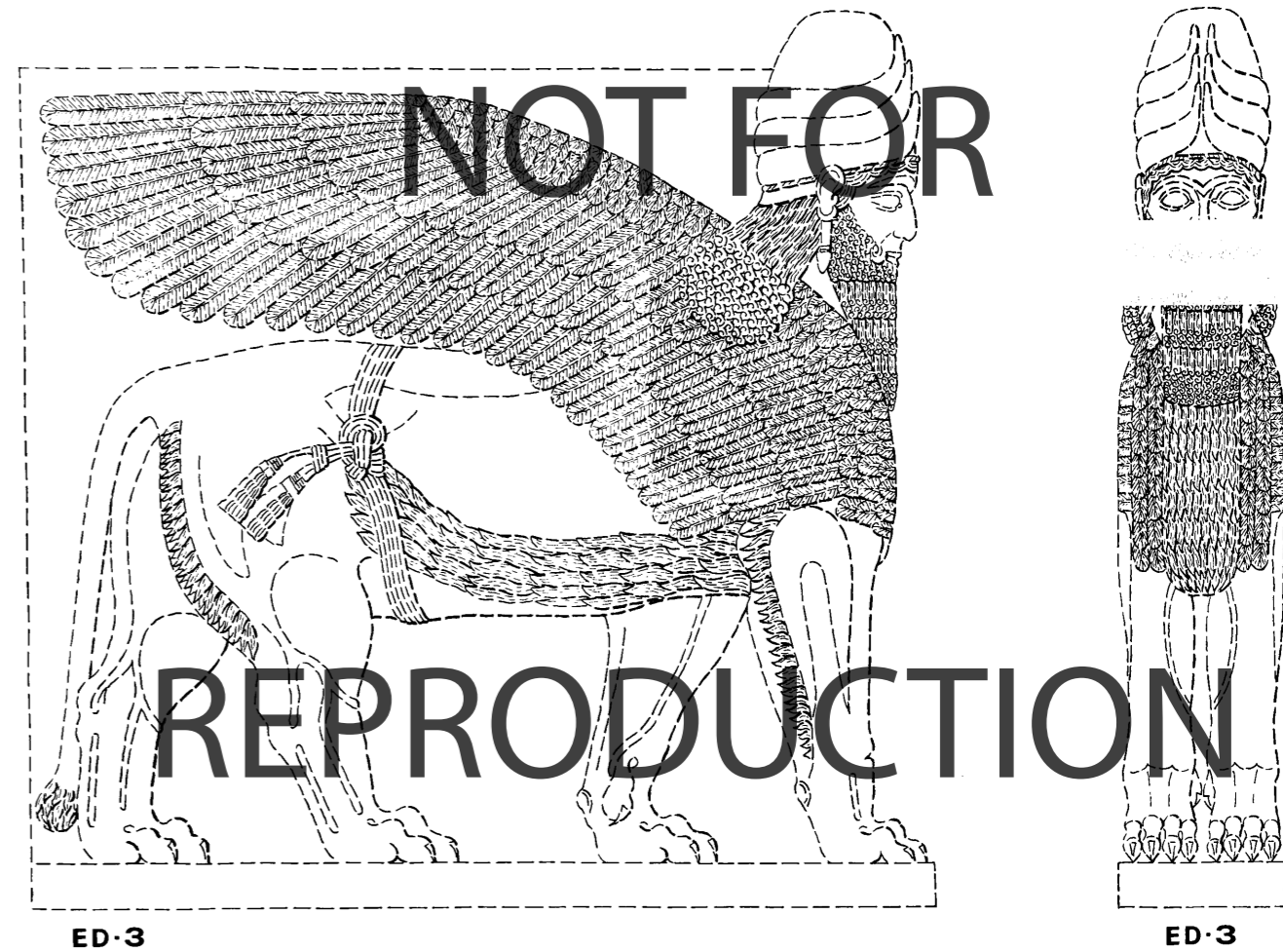
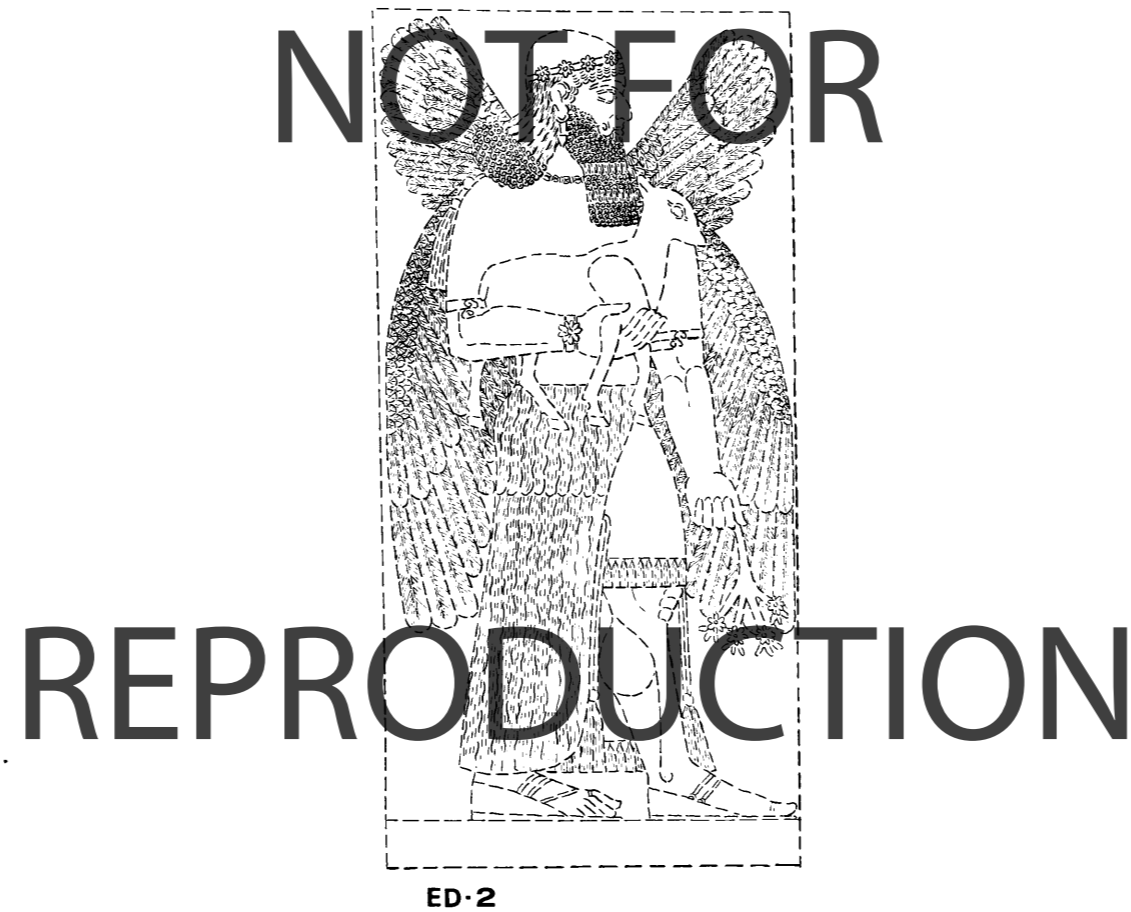
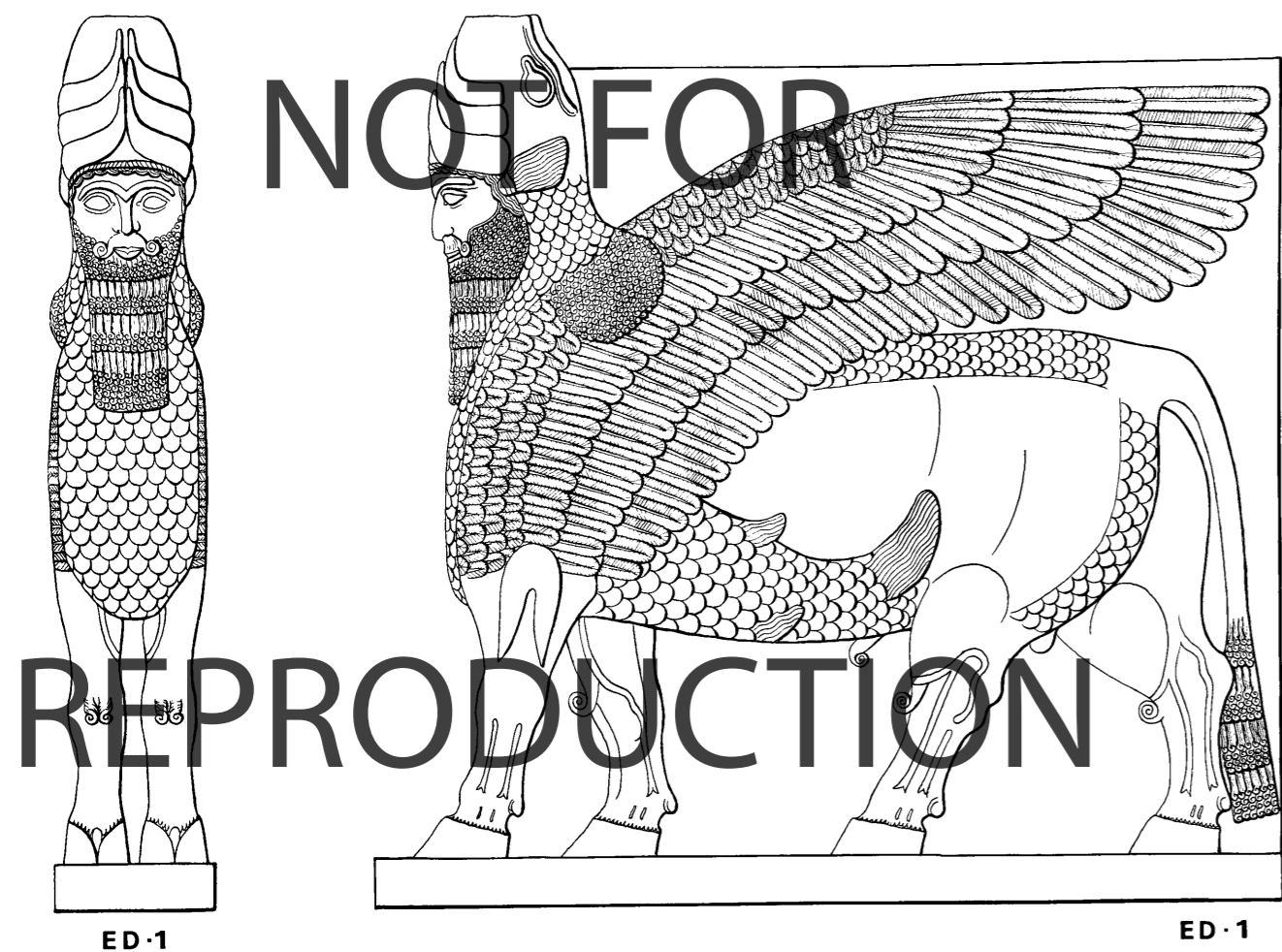

3.1 Eastern part of the façade (ED-1.ED-2.ED-3). Scale 1:40

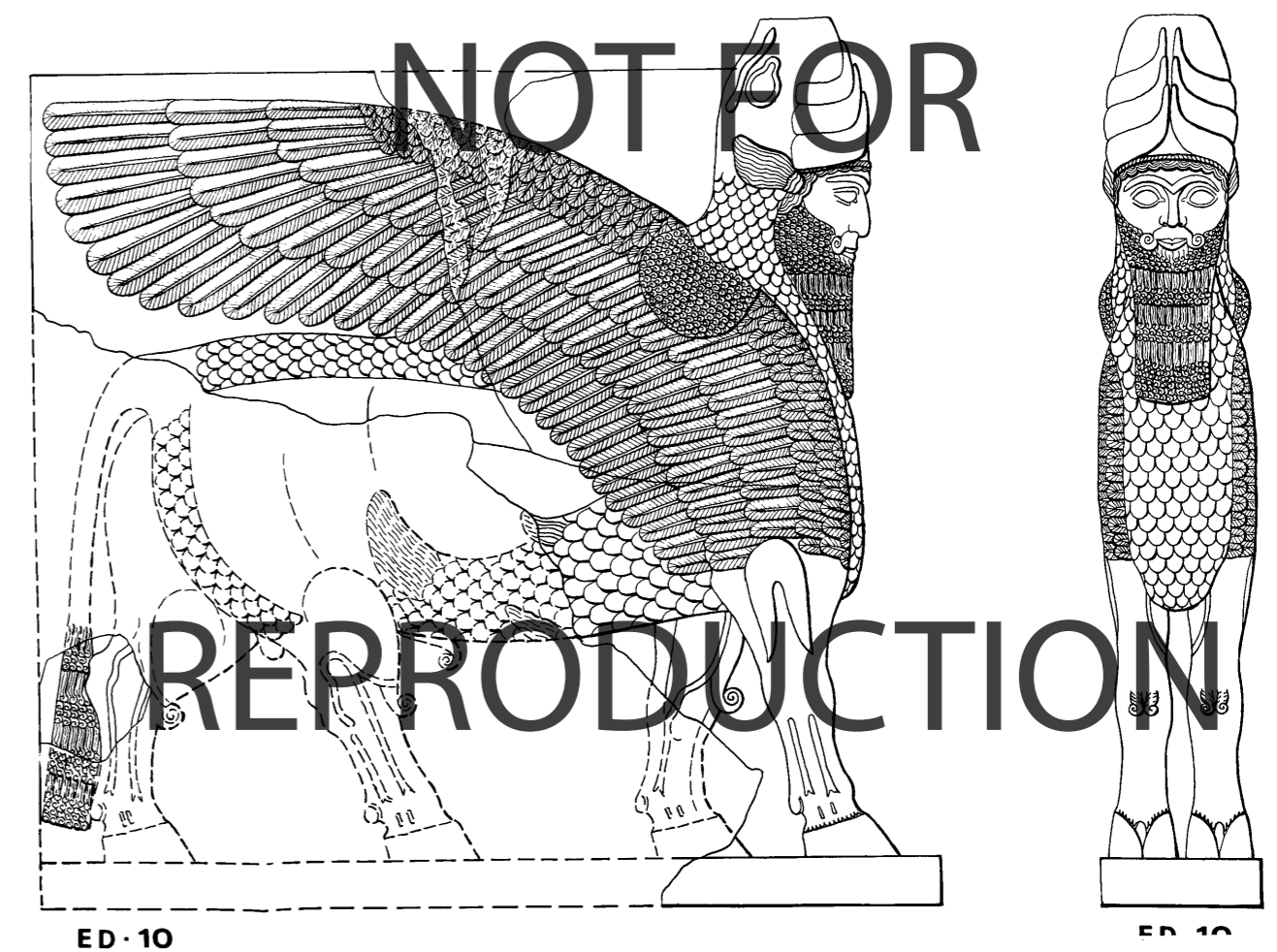
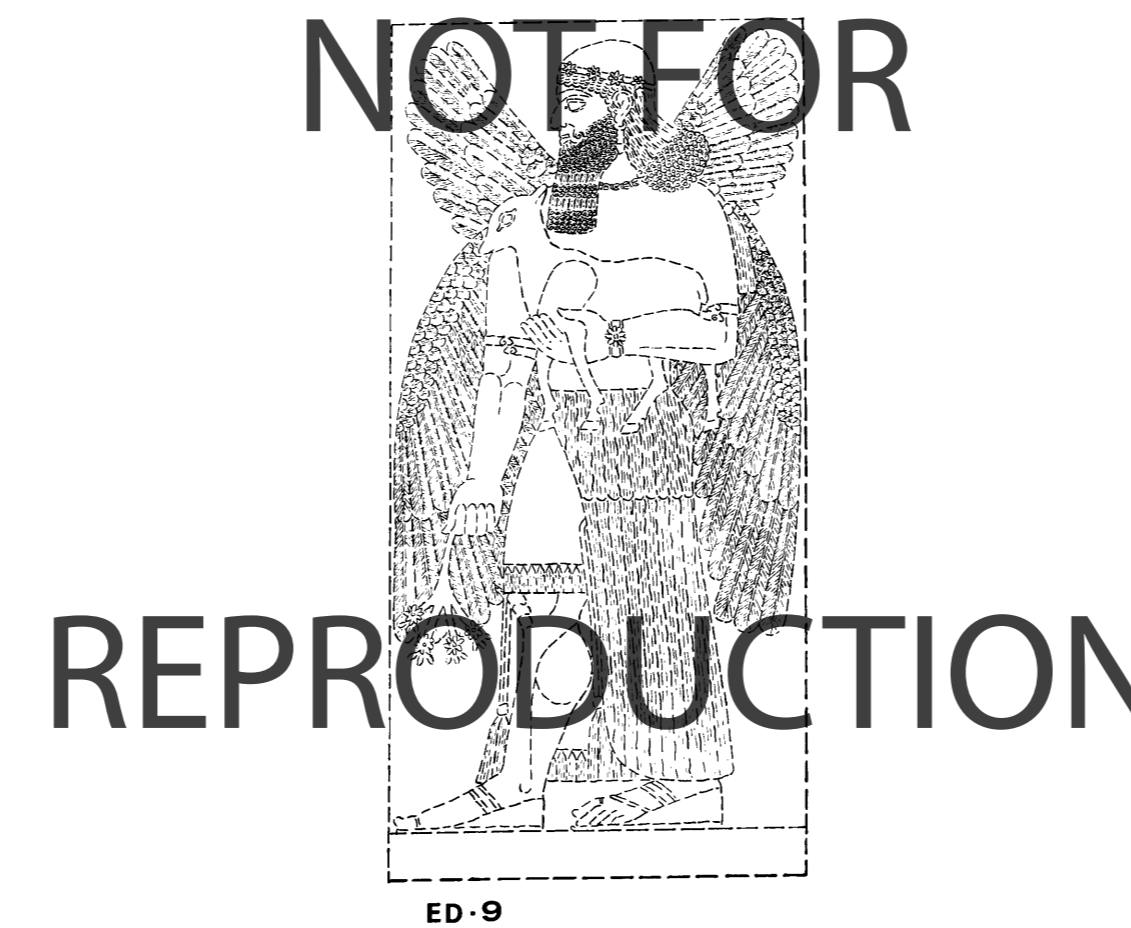
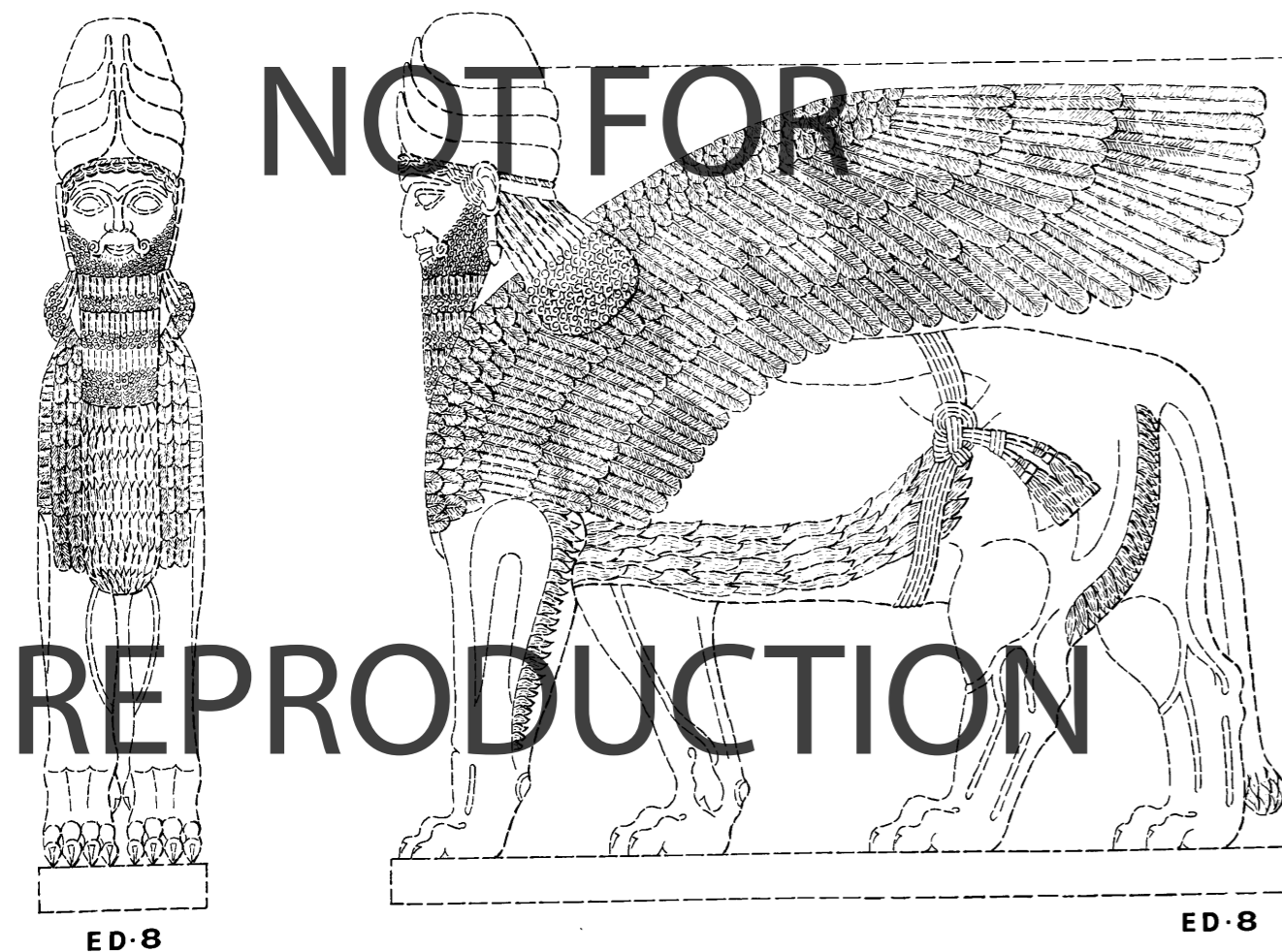

3.2 Western part of the façade (ED-8.ED-9.ED-10).Scale 1:40

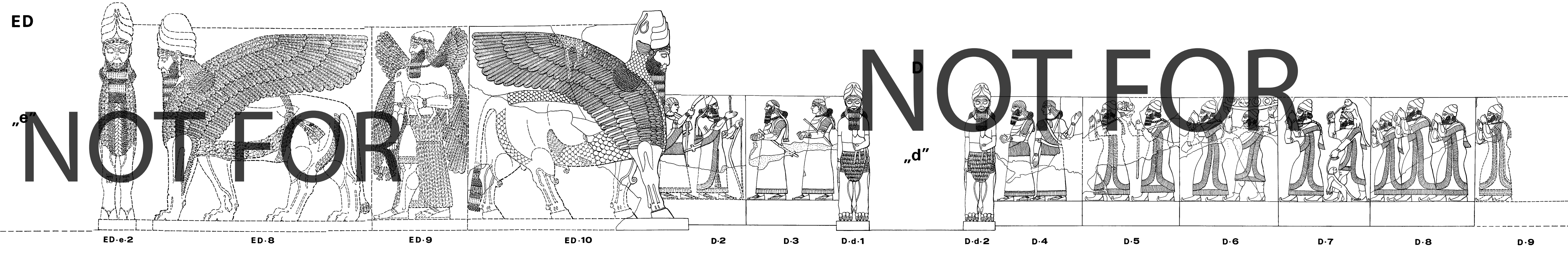
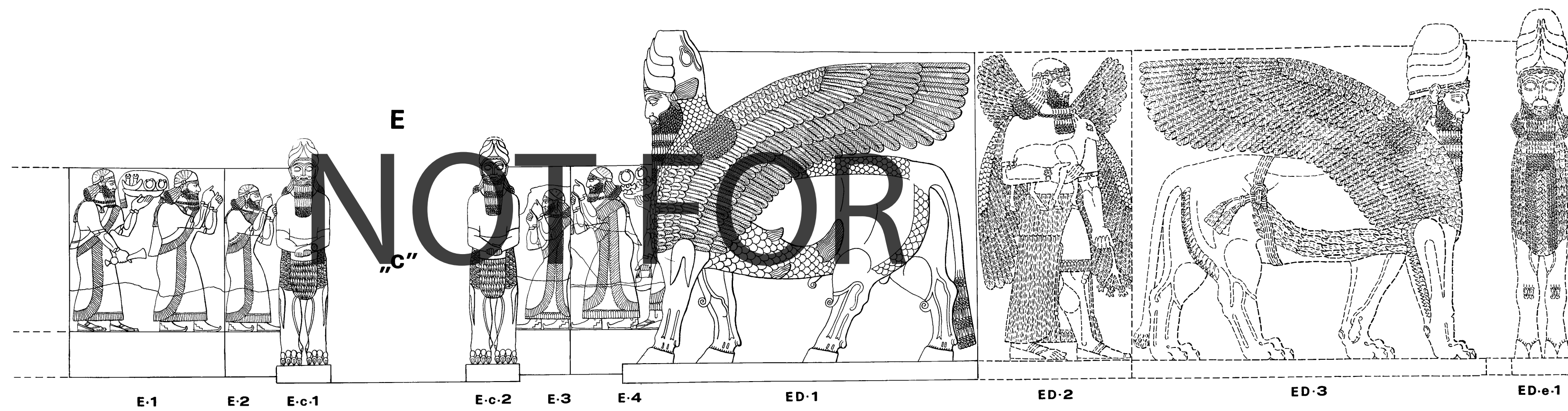

4.1 General view of the outer façade of the Throneroom.
 (E-1.E-2.E-c-1.entrance E-c.E-c-2.E-3.E-4.ED-1.ED-2.ED-3.ED-e-1.entrance ED-e.ED-e-2.ED-8.ED-9.ED-10.
 D-2.D-3.D-d-1.entrance D-d.D-d-2.D-4.D-5.D-6.D-7.D-8.D-9). Scale 1:50

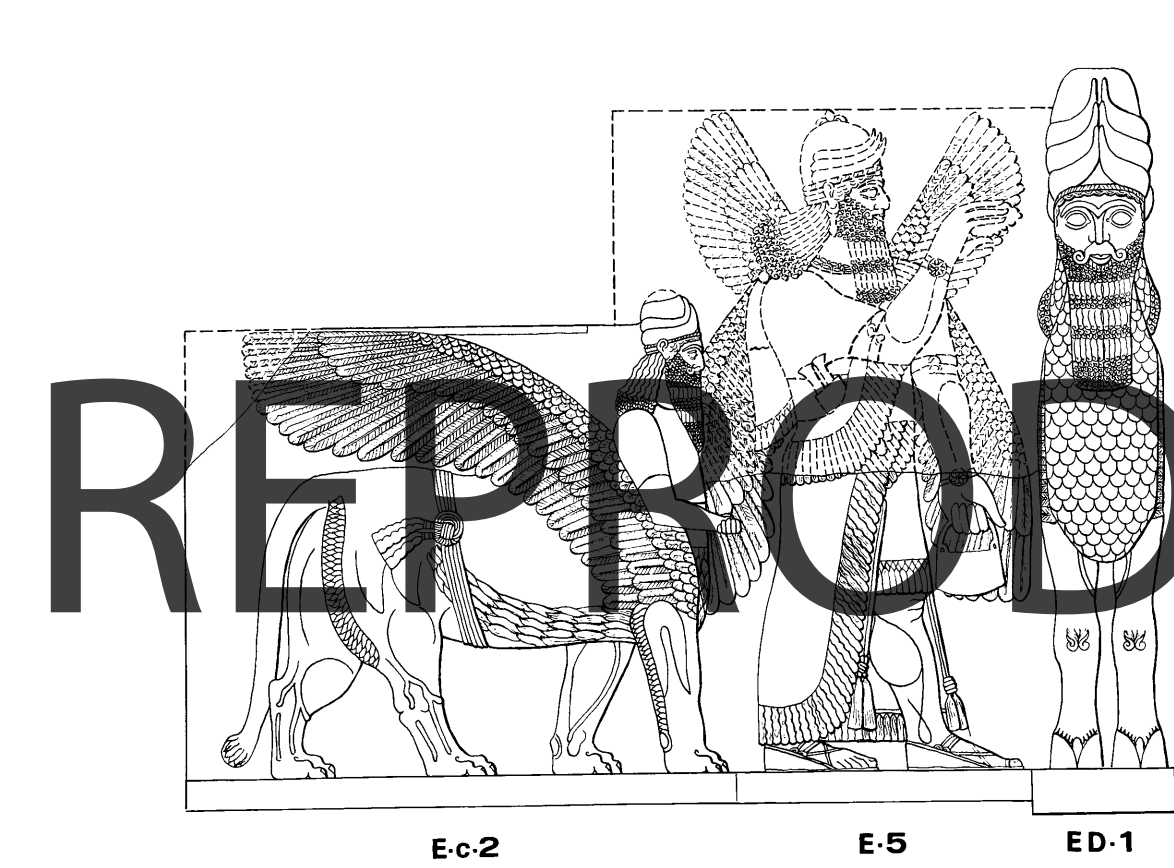

4.2 Western side of passageway E-c (E-c-2.E-5.ED-1). Scale 1:50

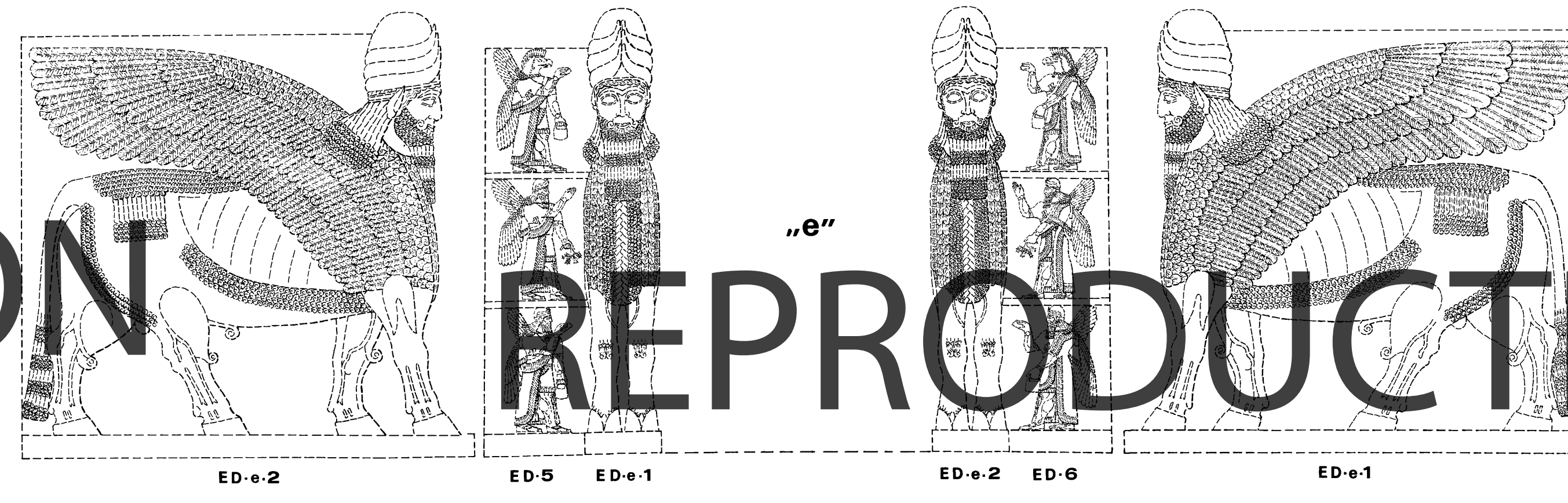

4.3 Reconstruction of the main entrance ED-e.Three-registered narrow reliefs on both sides of the front parts of the gigantic Lamassu-bulls deccating entranceway "e". Scale 1:50

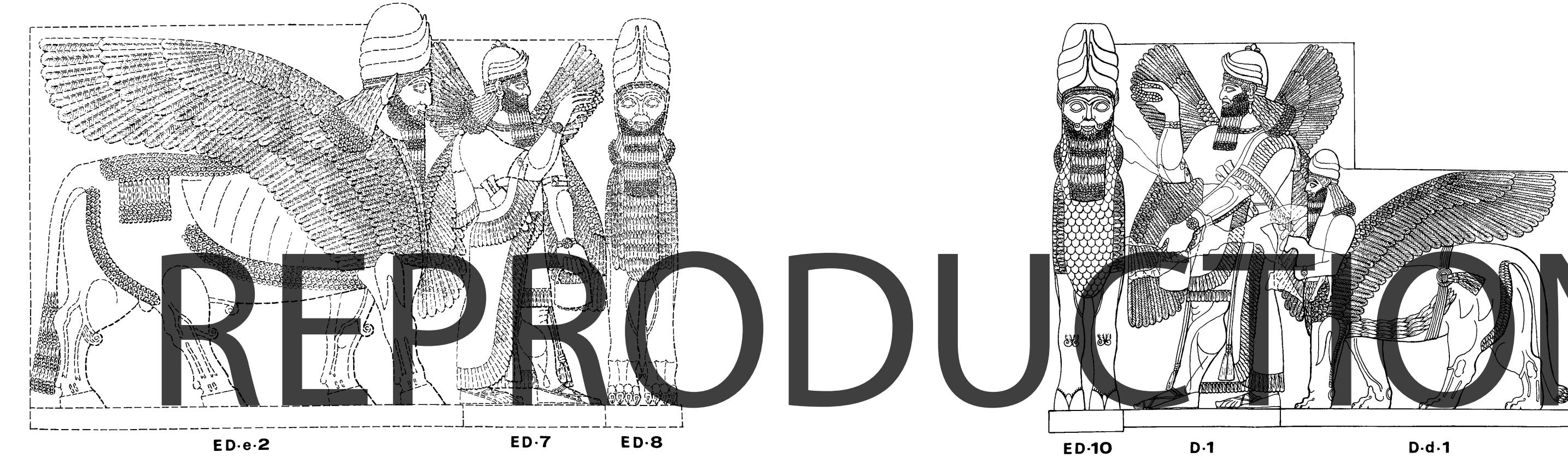

4.4 Western side of passageway ED-e (ED-e-2.ED-7.ED-8). Scale 1:50

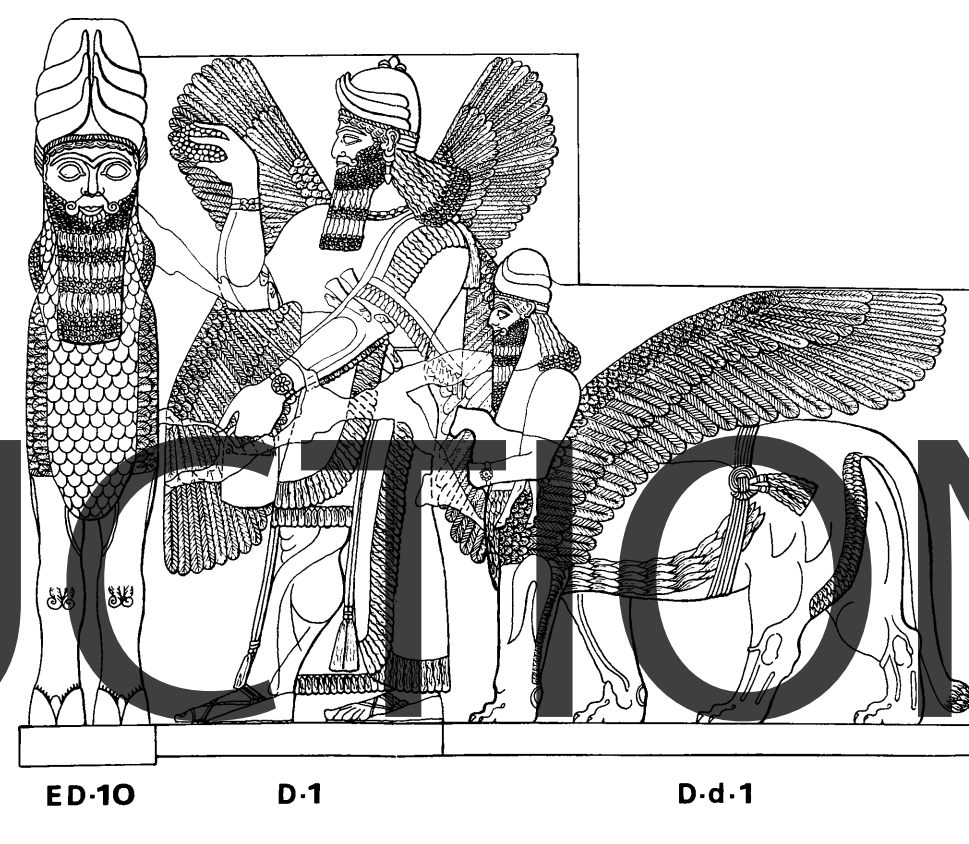

4.5 Eastern side of passageway D-d (ED-10.D-1.D-d-1). Scale 1:50

NOT FOR

NOT FOR

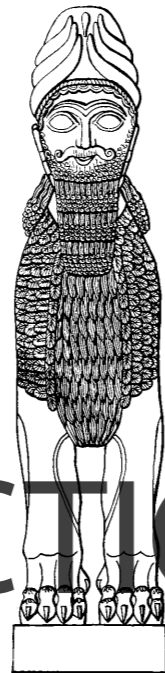
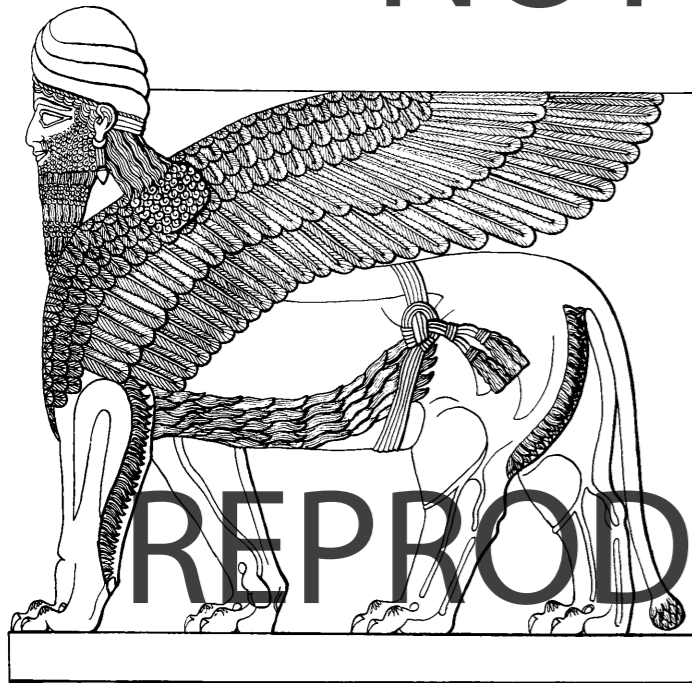

„a“

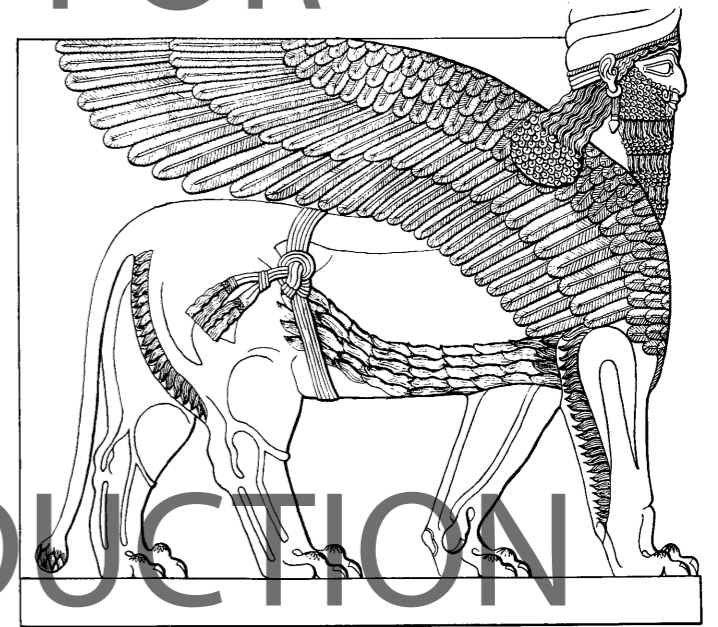

B-a-2

B-a-2

B-a-1

B-a-1

5.1 Entrance B-a (B-a-2.B-a-1). Scale 1:40

NOT FOR

NOT FOR

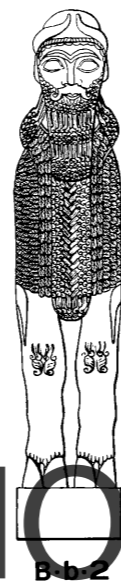

„b“

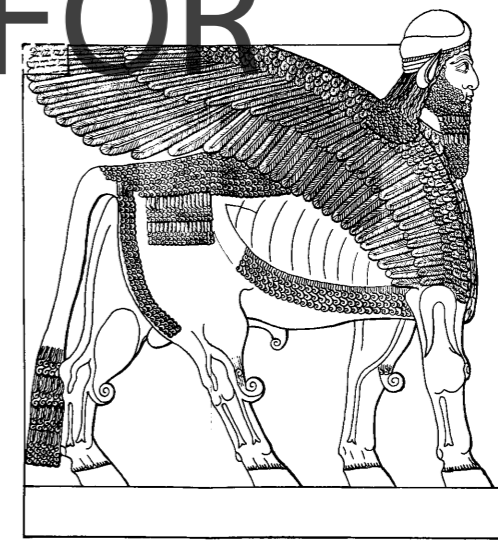

B-b-2

B-b-2

B-b-1

B-b-1

5.2 Entrance B-b (B-b-2.B-b-1). Scale 1:40

NOT FOR

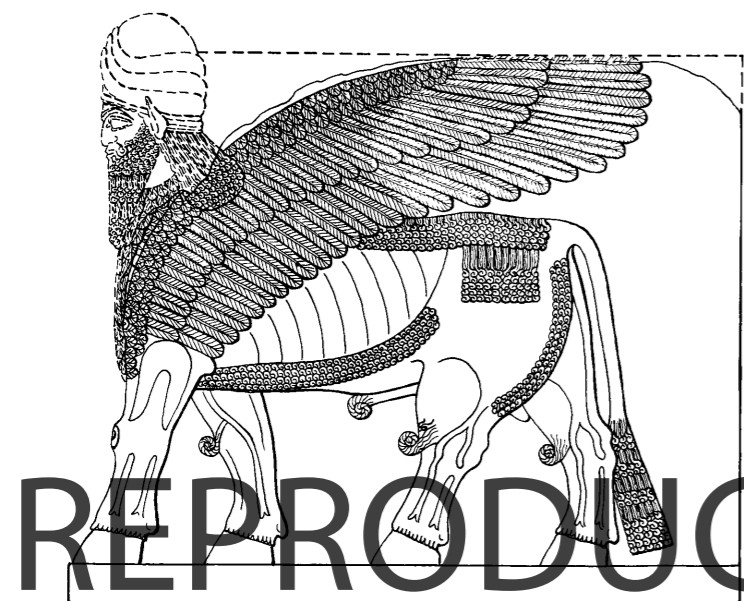

F-f-2

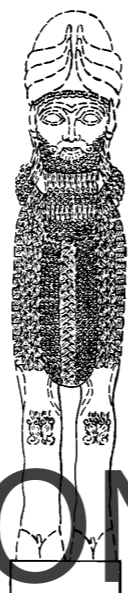

F-f-2

„f”



F-f-1

NOT FOR

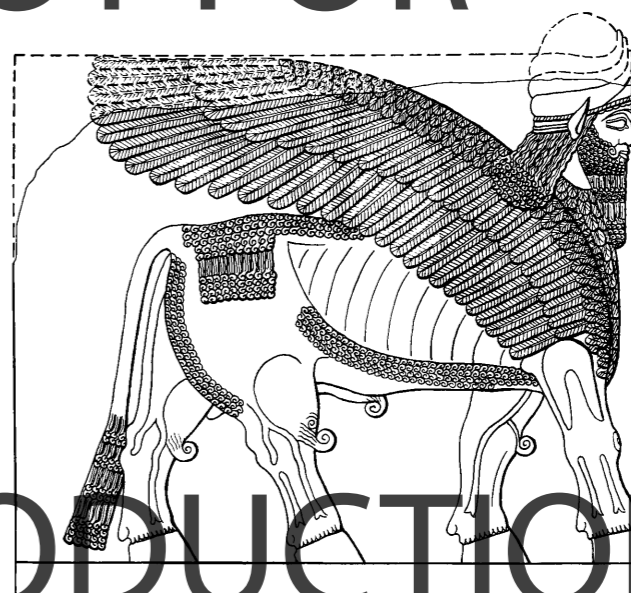

F-f-1

REPRODUCTION

REPRODUCTION

6.1 Entrance F-f (F-f-2.F-f-1). Scale 1:40

NOT FOR



G-b-1



G-b-1

„b”



G-b-2

NOT FOR



G-b-2

REPRODUCTION

REPRODUCTION

6.2 Entrance G-b G-b-1.G-b-2). Scale 1:40

NOT FOR

NOT FOR

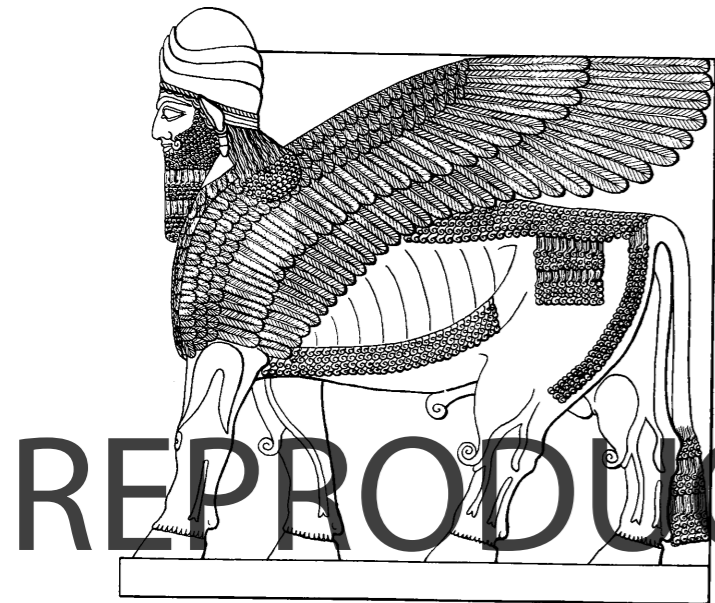

S-e-1

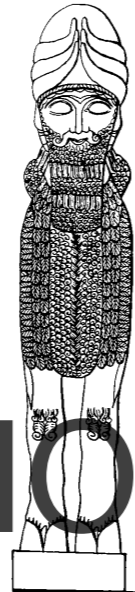

S-e-1

„e”

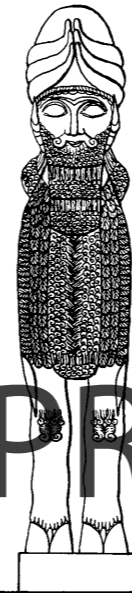

S-e-2

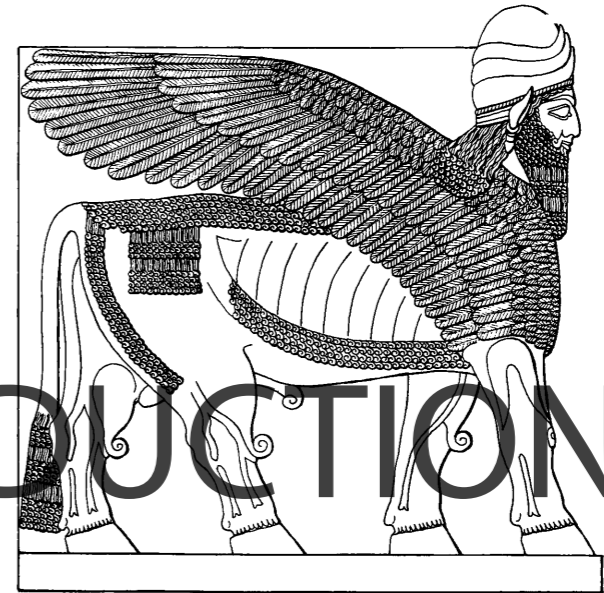

S-e-2

REPRODUCTION

REPRODUCTION

7.1 Entrance S-e (S-e-1.S-e-2). Scale 1:40

NOT FOR

NOT FOR

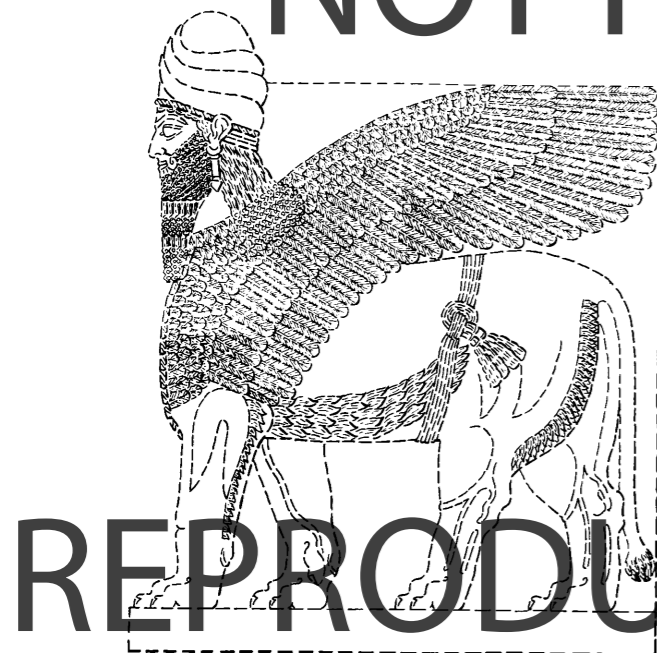

WG-g-1

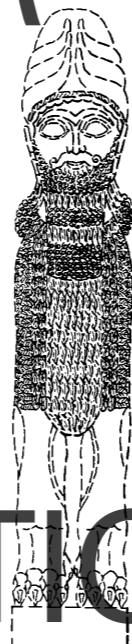

WG-g-1

„g”

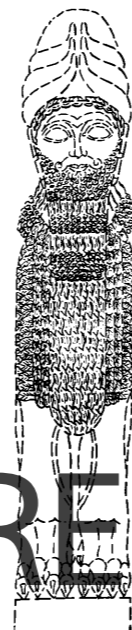

WG-g-2

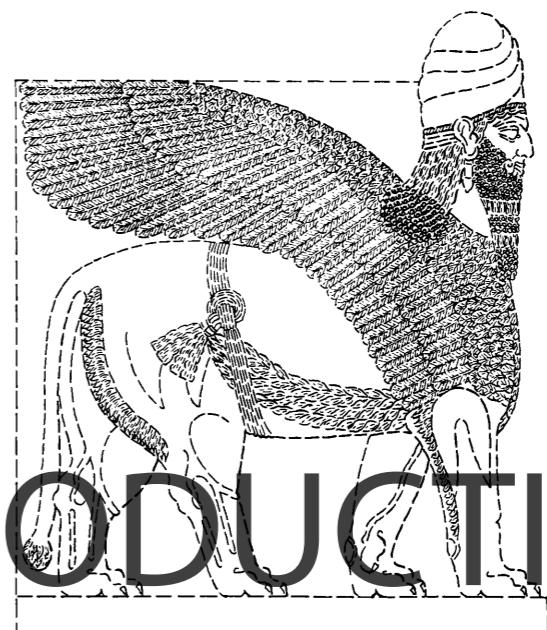

WG-g-2

REPRODUCTION

REPRODUCTION

7.2 Entrance WG-g (WG-g-1.WG-g-2). Scale 1:40

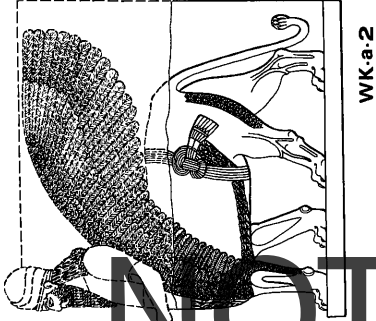

WK-a-2



WK-a-1



WK-a-2

"a"

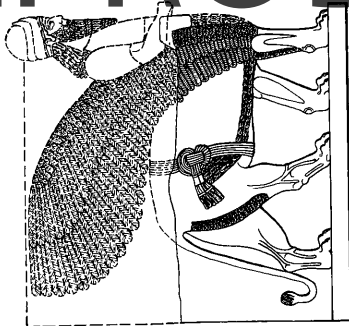

WK-a-1

8.1 Entrance WK-a (WK-a-1, WK-a-2), Scale 1:40





NOT FOR

REPRODUCTION

Courtyard WT

LEGEND FOR PLANS 1–3

SLABS

	Completely (or almost) preserved slabs
	Fragmentary preserved slabs
	Completely preserved socle
	No remains in situ (reconstruction)

WALLS

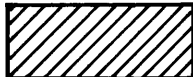
	Existing Wall Fragments (after excavations in the XIXth or XXth Century)
	Conjectural Walls (Theoretical Reconstruction)

B	– Sacred Tree
F	– Royal Army Official (Throne-Successor –?)
G	– Genius
H	– Courtier
I	– Standard Inscription
K	– King
LL	– Lamassu-Lion
LS	– Lamassu-Bull
N/N	– Narrative Relief in 2 Registers
N/N/N	– Narrative Relief in 3 Registers
O	– Officer
T	– Tribute Bearer

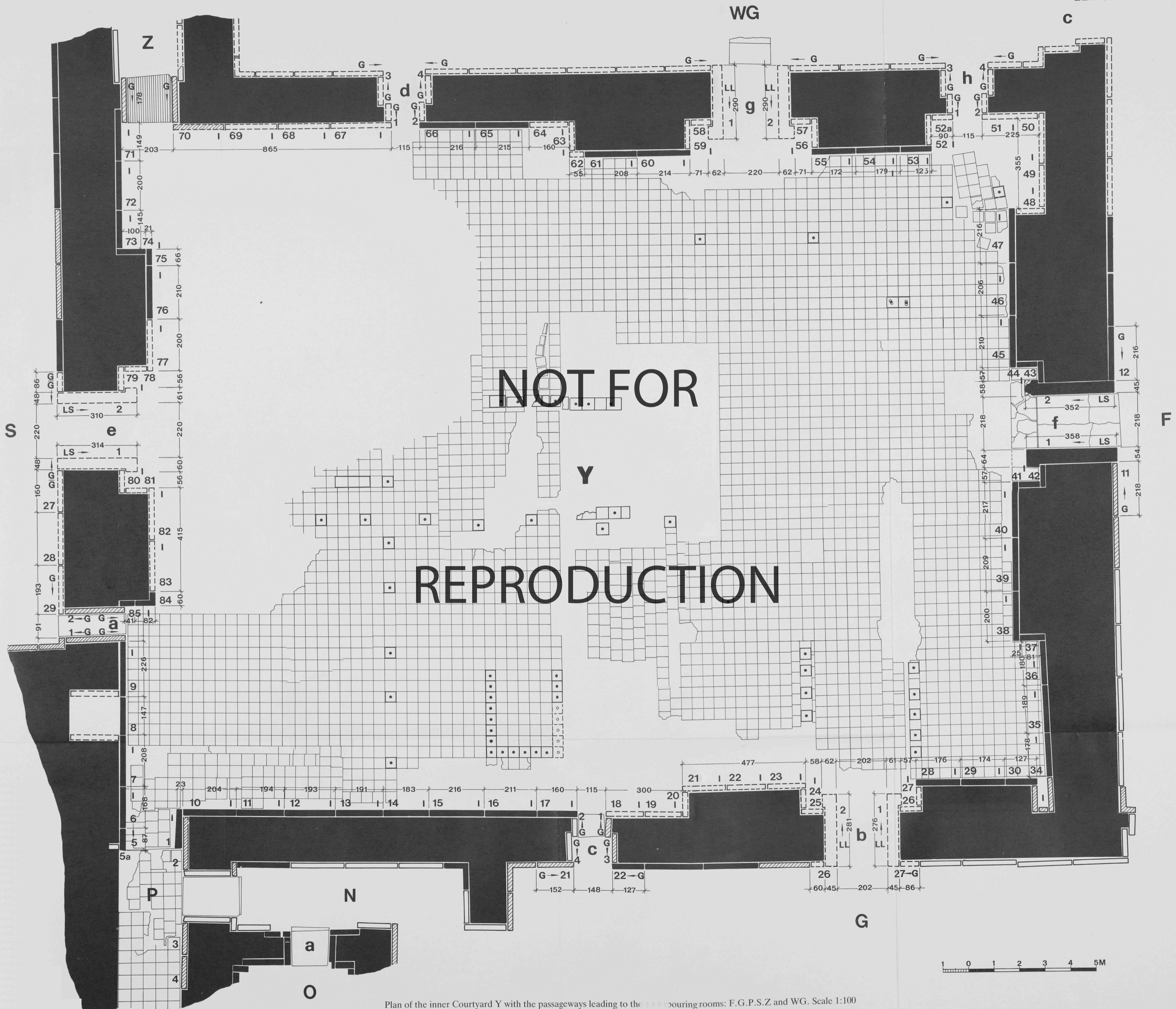
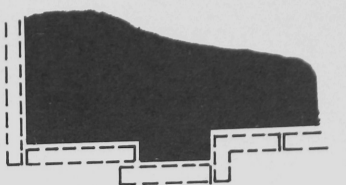
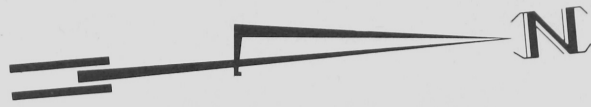

Plan of the inner Courtyard Y with the passageways leading to the neighbouring rooms: F.G.P.S.Z and WG. Scale 1:100

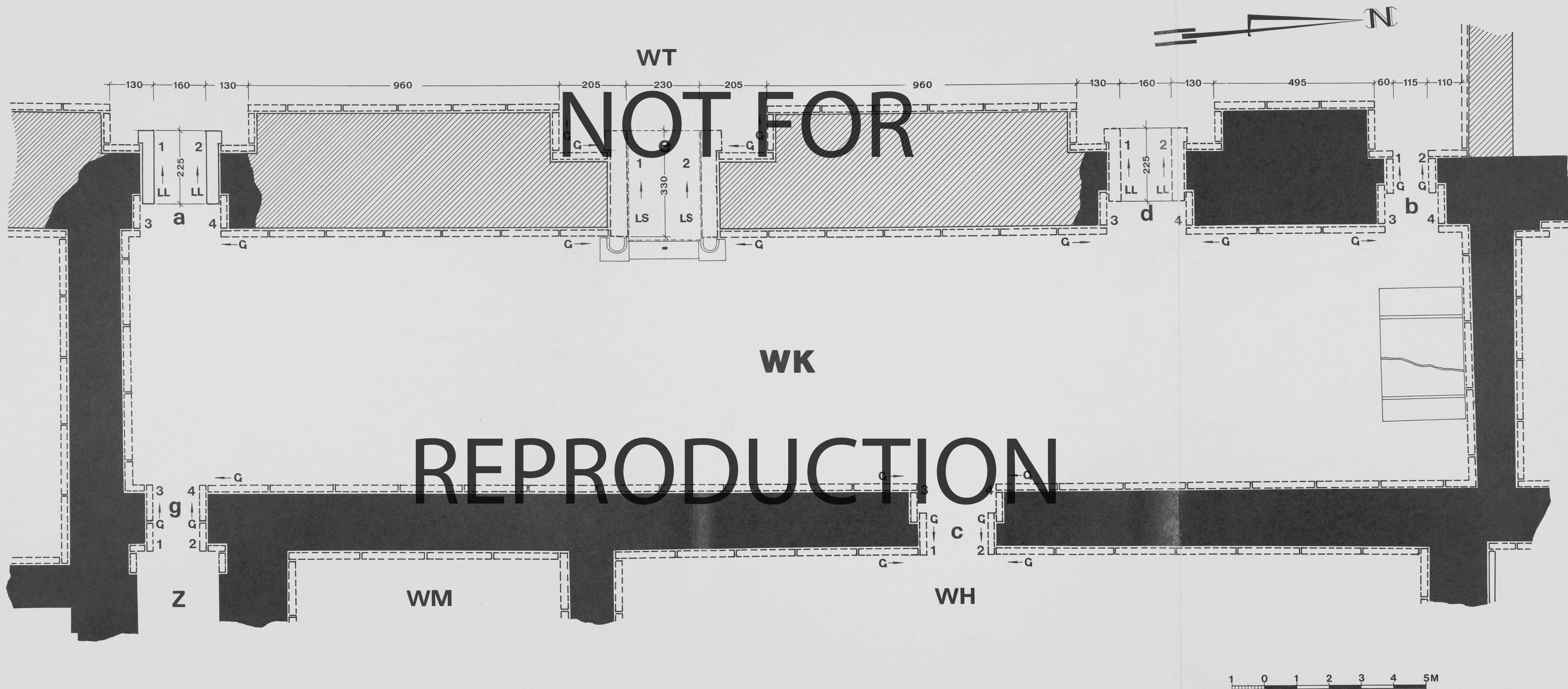

Plan of the western area of the West Wing. Room WK/(BB) with outer Courtyard WT (the reconstruction). Scale 1:100

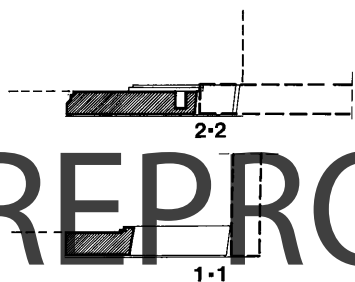
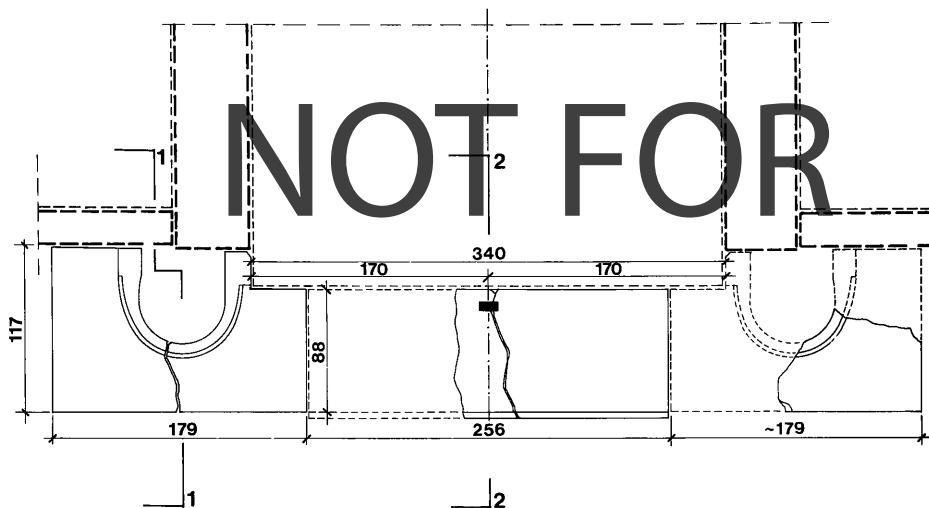

REPRODUCTION

The doorsill slabs of main entrance ED-e leading from courtyard ED to Throneroom B. Scale 1:40

NOT FOR

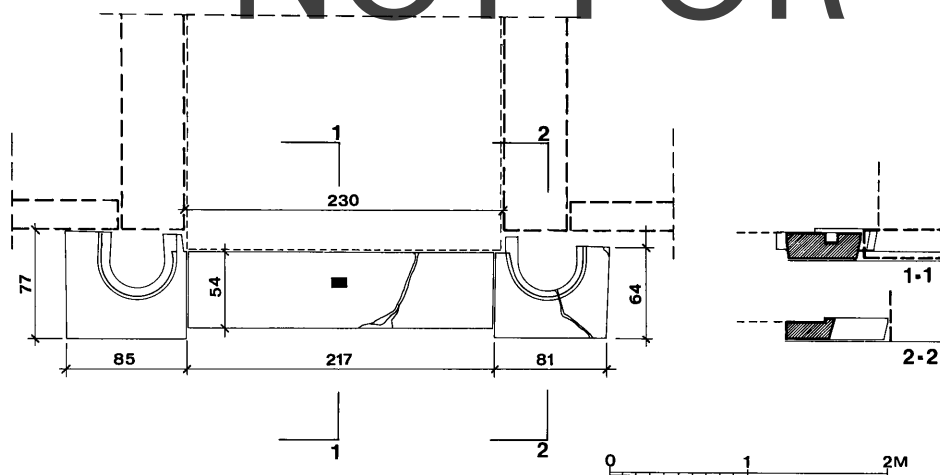

The doorsill slabs of the so-called "Second House" probably belonging to passageway WK-e joining outer Courtyard WT with room WK/(BB). Scale 1:40

REPRODUCTION

