

THE LONG ISLAND

GROUND WATER POLLUTION STUDY



New York State Department of Environmental Conservation

State University of New York
Stony Brook
LIBRARIES

FRANK MELVILLE JR. MEMORIAL LIBRARY
STONY BROOK UNIVERSITY

**Dr. Lee Koppelman
Collection**



THE LONG ISLAND GROUND WATER POLLUTION STUDY

prepared by

New York State Department of Health

in cooperation with

Nassau County Department of Health

Suffolk County Department of Health

Suffolk County Water Authority

The Lawman Company, Bethpage, New York

published by

NEW YORK STATE DEPARTMENT OF ENVIRONMENTAL CONSERVATION

South

X

TD

224

.N7

N 4664

1972

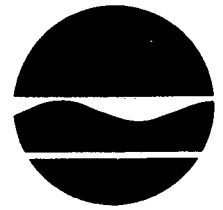

Henry L. Diamond
Commissioner

New York State Department of Environmental Conservation

Albany, N. Y. 12201

November 27, 1972

Honorable Henry L. Diamond, Commissioner
NYS Department of Environmental Conservation
50 Wolf Road
Albany, New York 12205

Dear Commissioner Diamond:

This study was requested by the Temporary State Commission on Water Resources Planning and was under the direction of the Special Advisory Group for the Study of the Detergent Pollution Problem. The actual work was directed by the Nassau-Suffolk Research Task Group which was composed of John M. Flynn, Chairman; Francis V. Padar, Co-chairman; August A. Guerrera, Barry Andres and William Graner.

This report was possible only because of the important contribution of four groups:

The devotion to the project exhibited by the Nassau-Suffolk Research Task Group and the people associated with the Group were not compensated for in terms of the financial returns received.

The interest of the State Legislature and its approval of funding to start the study.

The assistance provided by the Federal Government in funding Contract No. PH-86-63-201 for studying the passage of liquid wastes through unsaturated soils.

And lastly the help given by the manufacturers of various soaps and detergents which was coordinated through The Soap and Detergent Association.

62555100
00100

AC# 1186472

BF-10/10/72

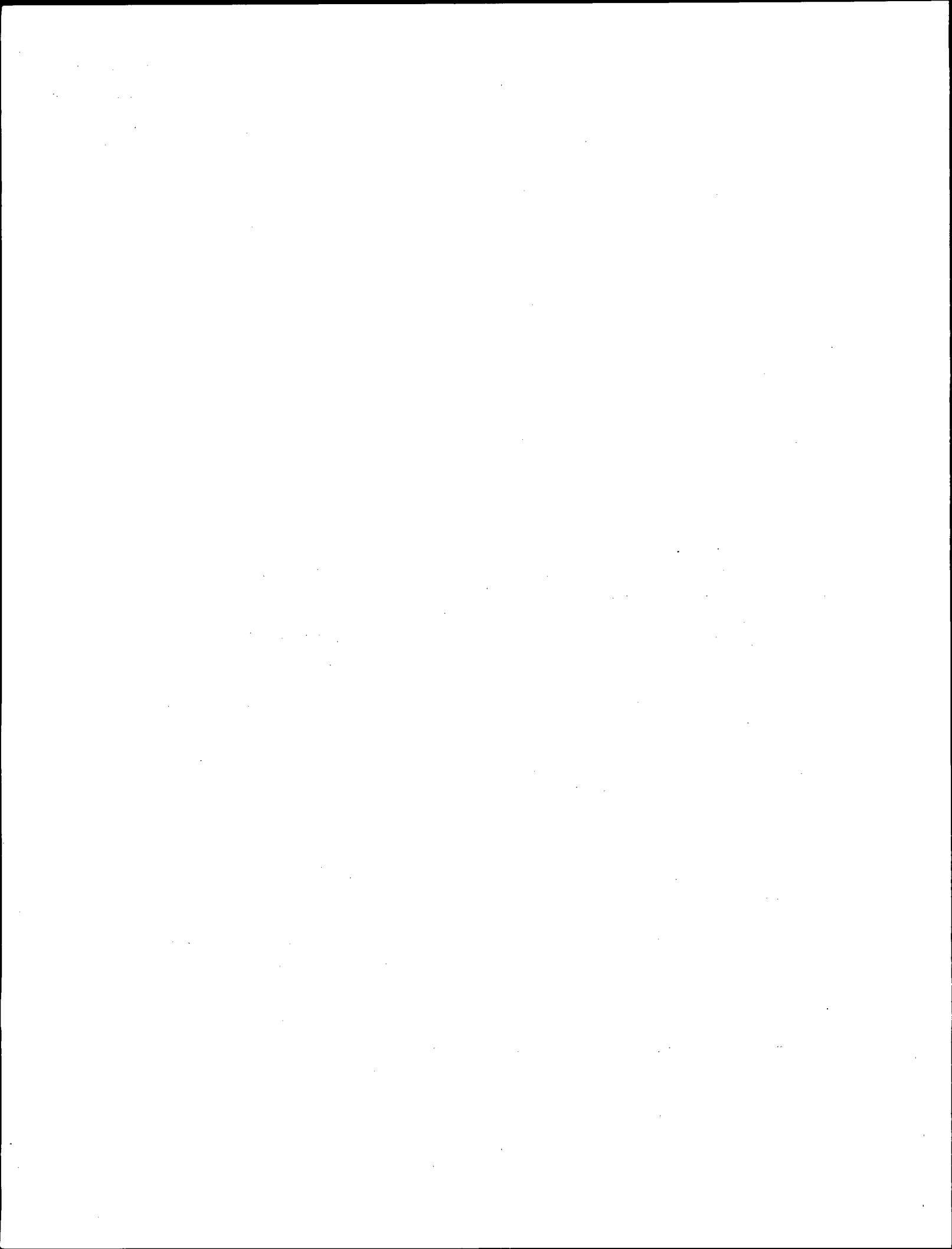

It was only by the interaction of all of these groups plus many persons that have not been singled out for mention here, that this whole undertaking was possible. Their contributions are gratefully acknowledged.

The recommendations are those of the Nassau-Suffolk Task Group - recommendations I might say in which I generally concur. However, I would be remiss if I did not comment on the appearance of the MBAS portion of the detergent in drinking water supplies. I do not believe that it should be present any more than members of the Task Group do but for slightly different reasons. As I read their recommendation I feel that they are looking at this material solely as a pollutant and are taking the approach that if filtration through the soil will not remove it, the substance should not be permitted to be discharged from the house. It is my opinion that the only source of this MBAS in drinking water is from the effluent of a sewage disposal system. While I recognize that it is a pollutant as listed in the Drinking Water Standards, I am more concerned with where it came from and what might be accompanying it. In other words, it is an indicator showing that there is a connection between some sewage disposal system and the water supply. The banning from use of such an indicator does not interfere with this direct connection. Instead the connection with sewage is only made less noticeable.

As a result of this study, I urge all the citizens of Nassau County and Suffolk County to intensify their efforts to provide methods of handling the sewage disposal problems there so as to give the utmost protection to Long Island's most valuable asset, a good supply of drinking water.

Sincerely,

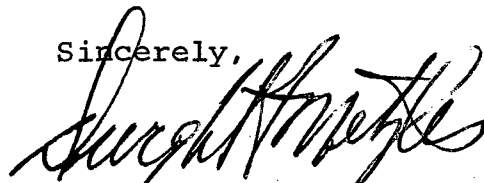

Dwight F. Metzler, P.E.
Deputy Commissioner

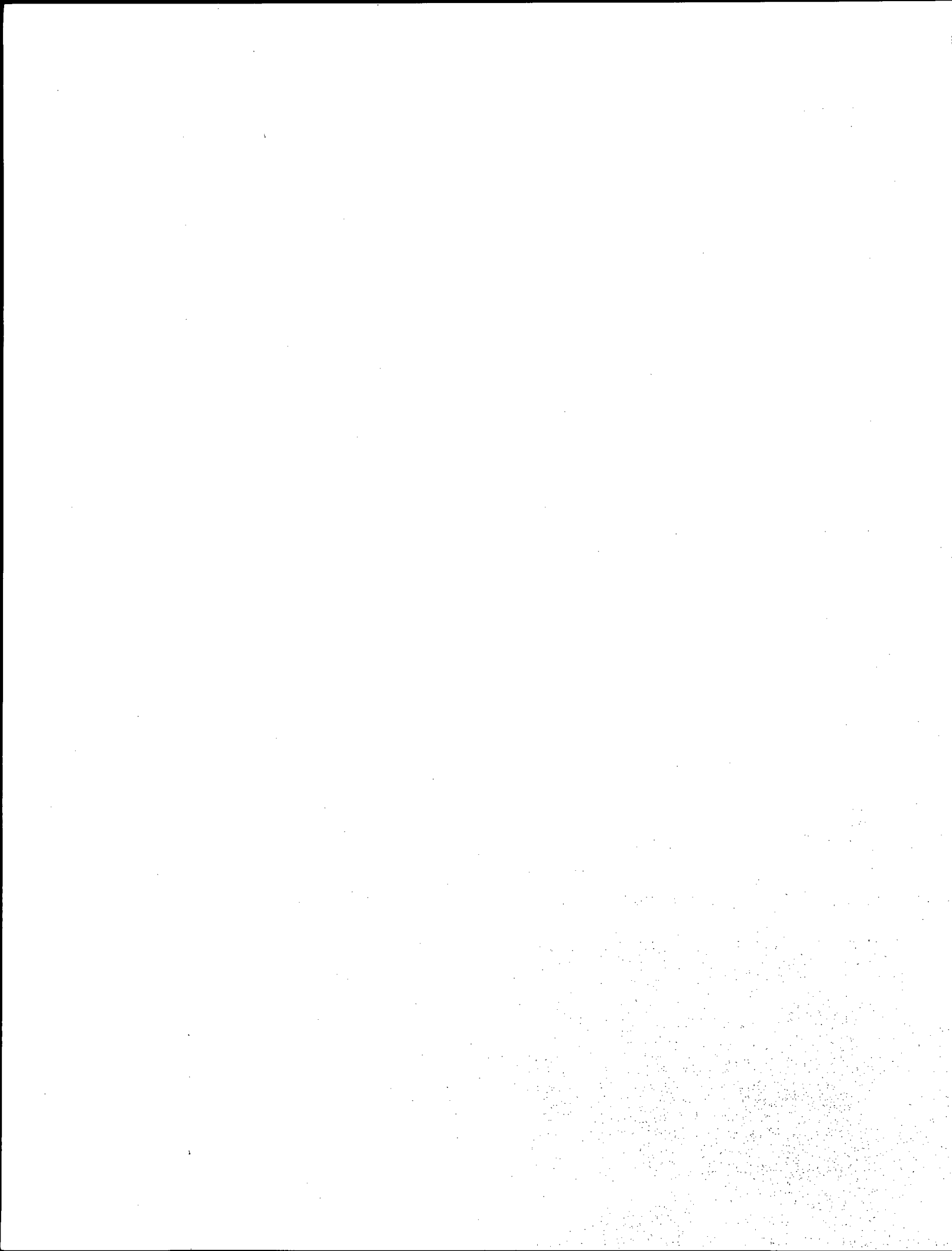

NASSAU-SUFFOLK RESEARCH TASK GROUP
THE LONG ISLAND GROUND WATER POLLUTION STUDY

April 15, 1969

Dwight F. Metzler
Deputy Commissioner
New York State Department of Health
84 Holland Avenue
Albany, New York

Dear Mr. Metzler:

An investigation of the pollution of ground water on Long Island has been conducted in accordance with contract of November 1, 1962 by the State Commissioner of Health with the Counties of Nassau and Suffolk, the Suffolk County Water Authority and The Lauman Company.

The study was performed under the aegis of the former temporary State Commission on Water Resources Planning which was empowered by the State Legislature in Chapter 530 of the Laws of 1962 to undertake such investigation and to make recommendations for any new legislation which may be necessary. Part of the work was funded through a grant from the United States Public Health Service. The final report of the Long Island Ground Water Pollution Study is transmitted herewith.

The study involved intensive field research of the effects of synthetic detergents and other sewage constituents discharged by typical individual sewage disposal systems on the quality of the ground water. Several types of detergent formulations were evaluated. Investigations were made in the zone of aeration as well as in the saturated subsoils.

The close cooperation and direct assistance of many federal, state and local governmental agencies, as well as proprietary organizations, is sincerely appreciated. Particular acknowledgement is accorded to Morris Cohn, Engineering Consultant to the Commission who catalyzed the active participation of the many organizations

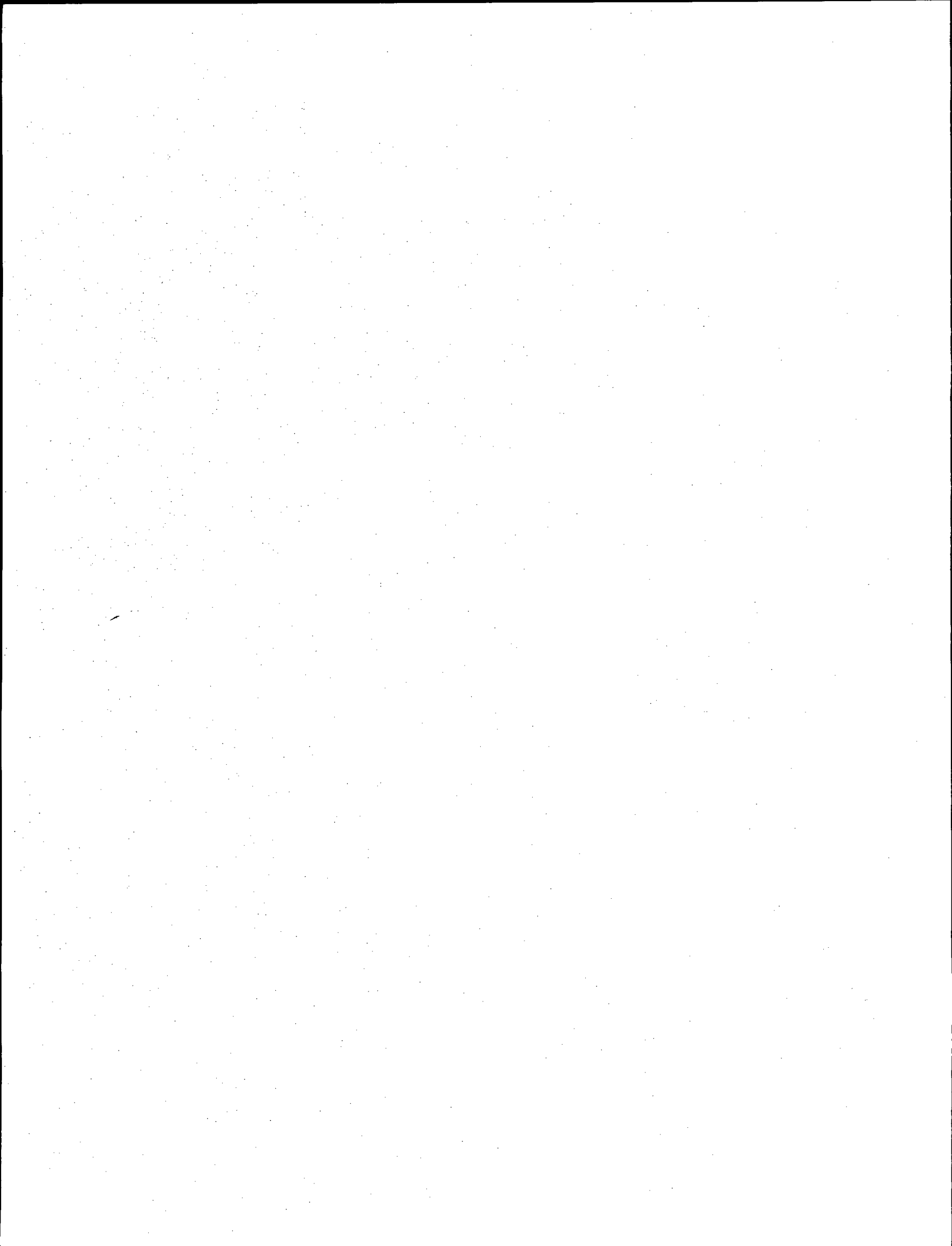

In the Technical Advisory Group of the Commission which periodically reviewed progress in the study. T. William Bendixen of the United States Public Health Service was extremely helpful in providing effective technical guidance in the area of soil science and was instrumental in obtaining Health Service funds for the studies in the zone of aeration. Allan Raymond of the State Department of Health provided valuable assistance in designing the radioactive tracer studies and preparing the report of that phase of the study.

The threat to the quality of the water resources on Long Island is of serious concern to local health officials. It is the earnest hope of the research task group that this report will be effective in clarifying the dimensions of the problem and pointing to the solutions.

Respectfully submitted,

NASSAU-SUFFOLK RESEARCH TASK GROUP

John M. Flynn, Chairman

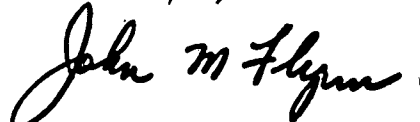

Francis V. Pader, Co-Chairman



August A. Guerrera



Barry Andres



William Graner

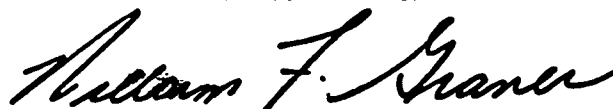

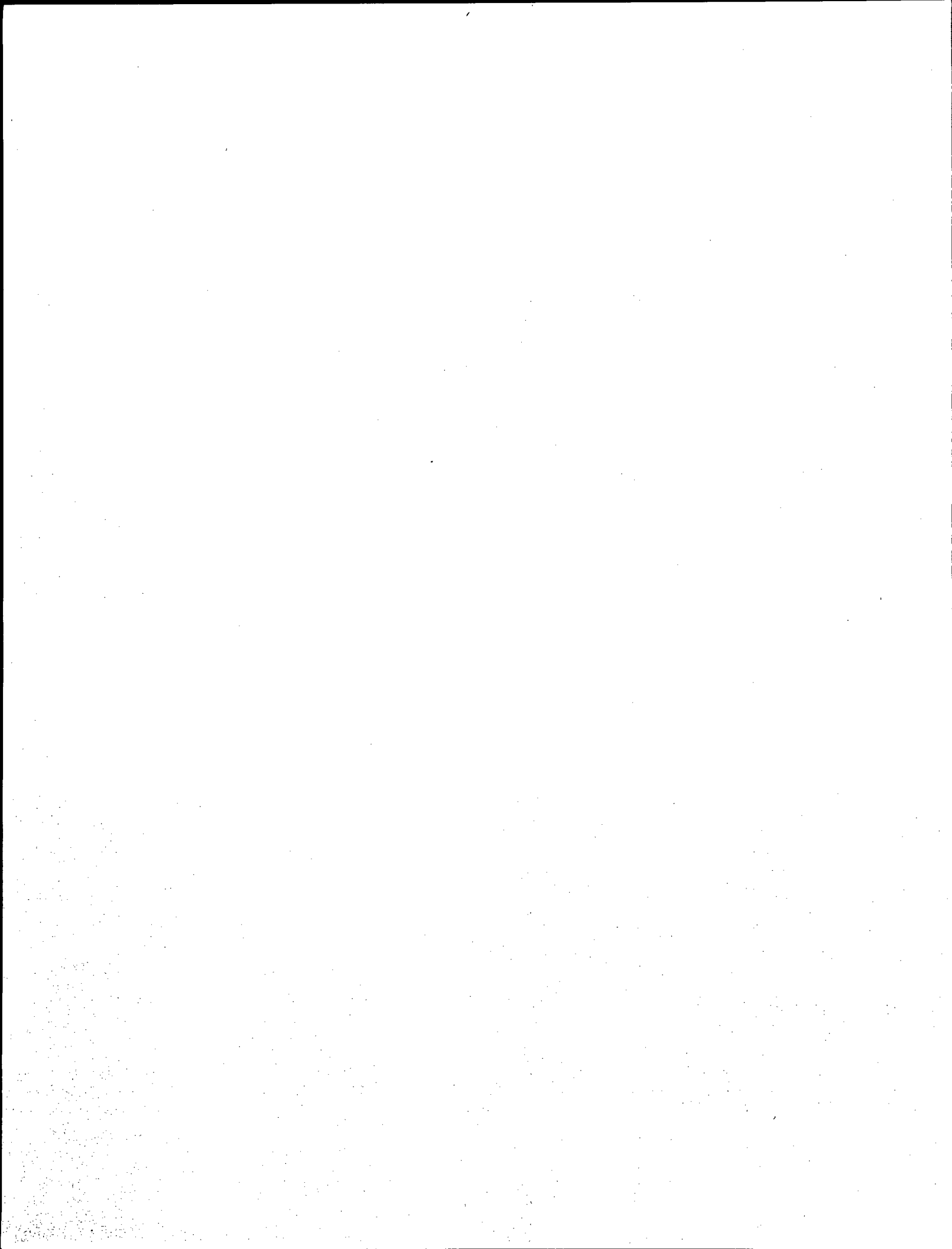

TABLE OF CONTENTS

	<u>Page</u>
LETTERS OF TRANSMITTAL	iii
LIST OF TABLES	xi
LIST OF FIGURES	xiv
PHOTOGRAPHS	xxi
ABBREVIATIONS	xxii
CONCLUSIONS	1-1
General	1-1
Attainment of Project Objectives	1-2
RECOMMENDATIONS	2-1
INTRODUCTION TO PROJECT	3-1
Long Island Geology and Water Resources	3-1
Hydrology	3-6
History of Ground Water Pollution	3-7
Legislative Action	3-12
Scope and Objectives of Project	3-14
Authorization for Project	3-15
Organization of Study Groups	3-16
Special Advisory Group for the Study of the Detergent Pollution Problem	3-17
Nassau-Suffolk Research Task Group	3-19
Description of Research Procedure	3-20
Description of Types of Cases	3-22
Chemical Analyses	3-23
Bacteriological Analyses	3-26
Analysis of Sewage	3-28
Sampling Frequency	3-28
Detergent Compounds	3-29
Soil Analysis	3-31
Site Procedure	3-31
SUMMARY AND SITE COMPARISONS	4-1
Background Well Data	4-1
Disposal System Concentrations	4-1
Detergent and Water Use	4-6
Effects of Different Subsoils	4-10
Ground Water Movement	4-11
Constituent Reduction Comparisons	4-13
SITE 1	5-1
Description and Development	5-1
Ground Water Movement	5-9
Travel of Waste Slug	5-11

TABLE OF CONTENTS cont.

	<u>Page</u>
Constituent Reductions	5-11
Chlorides	5-1
Infrared Analysis	5-15
MBAS as ABS	5-18
Dissolved Oxygen	5-23
pH	5-23
Ammonia	5-23
Nitrites	5-27
Nitrates	5-33
Sulfates	5-34
Phosphates	5-36
Coliform Organisms	5-39
Alkalinity	5-42
Specific Conductance	5-43
C O D	5-46
B O D	5-51
Total and Suspended Solids	5-52
 SITE 2	 6-1
Description and Development	6-1
Travel of Waste Slug	6-8
Chlorides	6-8
Infrared Analysis	6-11
MBAS as ABS	6-17
Dissolved Oxygen	6-21
pH	6-22
Ammonia	6-22
Nitrites	6-33
Nitrates	6-34
Sulfates	6-35
Phosphates	6-37
Coliform Organisms	6-40
Alkalinity	6-43
Specific Conductance	6-47
C O D	6-47
Total and Suspended Solids	6-53
B O D	6-53
Septic Tank	6-54
 SITE 3	 7-1
Description and Development	7-1
Sampling From Unsaturated Soil	7-8
Soil Moisture Profiles	7-13
Travel of Waste Slug	7-17
Chlorides	7-18
Infrared Analysis	7-24
MBAS as ABS	7-26
Radioactive Tagging Study	7-27
Phase I	7-27
Phase II	7-35

TABLE OF CONTENTS cont.

	<u>Page</u>
Dissolved Oxygen	7-43
Ammonia	7-43
Nitrites	7-44
Nitrates	7-50
Sulfates	7-51
Phosphates	7-53
Coliform Organisms	7-54
Alkalinity	7-59
Specific Conductance	7-62
C O D	7-65
B O D	7-68
Total and Suspended Solids	7-68
 SITE 4	 8-1
Description and Development	8-1
Travel of Waste Slug	8-5
Chlorides	8-5
MBAS as ABS	8-6
Dissolved Oxygen	8-13
pH	8-13
Ammonia	8-13
Nitrites	8-15
Nitrates	8-15
Sulfates	8-18
Phosphates	8-20
Coliform Organisms	8-22
Alkalinity	8-24
Specific Conductance	8-26
C O D	8-28
B O D	8-28
Total and Suspended Solids	8-30
 SITES 5 AND 6,	 9-1
Introduction	9-1
Description	9-1
Waste Plume Location	9-6
Test Well Installation	9-8
Sample Collection	9-11
Water Use	9-11
Product Use	9-12
Results of Analyses	9-12
Chlorides	9-21
MBAS as ABS	9-23
Infrared Analyses	9-25
Dissolved Oxygen	9-25
pH	9-26
Ammonia	9-26
Nitrites	9-27
Nitrates	9-27

TABLE OF CONTENTS cont.

	<u>Page</u>
Sulfates	9-30
Phosphates	9-30
Coliform Organisms	9-32
Alkalinity	9-32
Specific Conductance	9-34
C O D	9-36
B O D	9-36
Total and Suspended Solids	9-37
Comparison with Other Studies	9-37
RADIOACTIVE TAG STUDIES	10-1
Objectives	10-1
Health Hazards	10-1
Sampling and Analysis Procedures	10-3
Phase I	10-4
Phase II	10-6

LIST OF TABLES

<u>Table</u>		<u>Page</u>
4-1	Background Well Concentrations	4-2
4-2	Disposal System Concentrations	4-3
4-3	Product and Water Use	4-7
4-4	MBAS Concentration in Disposal System	4-16
4-5	Average Dissolved Oxygen Concentrations	4-22
4-6	Percent Reduction of Free Ammonia	4-25
4-7	Ammonia Reductions	4-26
4-8	Average Concentrations of Nitrogen Products	4-28
4-9	Sulfate Reductions in Saturated Zone	4-30
4-10	Computed and Actual Phosphates in Disposal Systems	4-32
4-11	Average Coliform Density	4-36
5-1	Geologist's Log of Test Hole at Site 1	5-5
5-2	Summary of Soil Analysis	5-6
5-3	Observation Well Concentrations, Site 1	5-12
5-4	Percent Remaining of First Well Concentration, Site 1	5-14
6-1	Observation Well Concentrations - Site 2	6-9
6-2	Percent Remaining of First Well Concentration, Site 2	6-12
6-3	BOD and Solids - Site 2	6-56
7-1	Site 3 - Observation Well Concentrations	7-19
7-2	Site 3 - Test Shaft Concentrations	7-20
7-3	Site 3 - Percent Remaining of First Well Concentration	7-21
7-4	Summary Data - Phase 1 - Radioactive Tag Study Site 3	7-31

LIST OF TABLES cont.

<u>Table</u>		<u>Page</u>
7-5	Summary Data - Phase I - Radioactive Tag Study	7-33
7-6	Summary Data - Phase II - Radioactive Tag Study - Site 3	7-37
7-7	Summary Data - Phase I - Radioactive Tag Study	7-40
7-8	Summary Data - Phase II - Radioactive Tag Study (Soil and Sludge)	7-41
8-1	Observation Well Concentrations - Site 4	8-7
8-2	Percent Remaining of First Well Concentrations	8-8
9-1	MBAS in Ground Water - Site 5	9-7
9-2	MBAS in Ground Water - Site 6	9-9
9-3	Site 5 - Reduction in Sewage Constituents... Test Product - LAS	9-13
9-4	Site 5 - Reduction in Sewage Constituents... Test Product - AS	9-14
9-5	Site 5 - Reduction in Sewage Constituents... Test Product - Soap	9-15
9-6	Site 5 - Reduction in Sewage Constituents... Test Product - ABS	9-16
9-7	Site 6 - Reduction in Sewage Constituents... Test Product - LAS	9-17
9-8	Site 6 - Reduction in Sewage Constituents... Test Product - AS	9-18
9-9	Site 6 - Reduction in Sewage Constituents... Test Product - Soap	9-19
9-10	Site 6 - Reduction in Sewage Constituents... Test Product - ABS	9-20
9-11	Chloride Reduction Through Percolation Fields	9-22
9-12	Site 5 and 6 - MBAS	9-24

LIST OF TABLES cont.

<u>Table</u>		<u>Page</u>
9-13	Nitrogen Values - Sites 5 and 6	9-29
9-14	Colliform Organisms - Sites 5 and 6	9-33
9-15	Alkalinity - Sites 5 and 6	9-35
9-16	Specific Conductance - Sites 5 and 6	9-35
9-17	Removal of Synthetic Detergents by Percolation Fields	9-42
10-1	Radioisotope Activity - Phase I	10-10
10-2	Radioisotope Activity - Phase II	10-13
10-3	Radioisotope Activity - Phase II Sludge-Soil Core Samples	10-21

LIST OF FIGURES

<u>Figure</u>		<u>Page</u>
3-1	Generalized Cross Section, Geological Formations	3-2
3-2	Long Island Ground Water Pollution Study Site Locations	3-24
3-3	Long Island Ground Water Pollution Study Sampling Pump	3-27
5-1	Site Plan - Site 1	5-2
5-2	Profile, Test Well - Site 1	5-3
5-3	Profile, Test Well - Site 1	5-4
5-4	Chlorides - Reduction Versus Travel Time	5-16
5-5	Chlorides - Percent Remaining of First Well Concentration	5-17
5-6	MBAS reported as ABS - Percent Remaining of First Well Concentration	5-20
5-7	MBAS reported as ABS - Reduction Versus Travel Time	5-21
5-8	Ammonia - Reduction Versus Travel Time	5-25
5-9	Ammonia - Percent Remaining of First Well Concentration	5-26
5-10	ABS in Use - Nitrogen Cycle Versus Travel Time	5-28
5-11	LAS in Use - Nitrogen Cycle Versus Travel Time	5-29
5-12	Soap in Use - Nitrogen Cycle Versus Travel Time	5-30
5-13	LAS in Use - Nitrogen Cycle Versus Travel Time	5-31
5-14	AS in Use - Nitrogen Cycle Versus Travel Time	5-32
5-15	Sulfates - Reduction Versus Travel Time	5-35
5-16	Total Phosphates - Reduction Versus Travel Time	5-37
5-17	Total Phosphates - Percent Remaining of First Well Concentration	5-38
5-18	Log Average Coliform - Reduction Versus Travel Time	5-40

LIST OF FIGURES cont.

<u>Figure</u>		<u>Page</u>
5-19	Log Average Coliform - Percent Remaining of First Well Concentration	5-41
5-20	Alkalinity - Reduction Versus Travel Time	5-44
5-21	Alkalinity - Percent Remaining of First Well Concentration	5-45
5-22	Specific Conductance - Reduction Versus Travel Time	5-47
5-23	Specific Conductance - Percent Remaining of First Well Concentration	5-48
5-24	COD - Reduction Versus Travel Time	5-49
5-25	COD - Percent Remaining of First Well Concentration	5-50
5-26	ABS in Use - Reduction Versus Travel Time	5-53
5-27	ABS in Use - Percent Remaining of First Well Concentration	5-54
5-28	LAS in Use - Reduction Versus Travel Time	5-55
5-29	Las in Use - Percent Remaining of First Well Concentration	5-56
5-30	Soap in Use - Reduction Versus Travel Time	5-57
5-31	Soap in Use - Percent Remaining of First Well Concentration	5-58
5-32	LAS in Use - Reduction Versus Travel Time	5-59
5-33	LAS in Use - Percent Remaining in First Well Concentration	5-60
5-34	AS in Use - Reduction Versus Travel Time	5-61
5-35	AS in Use - Percent Remaining of First Well Concentration	5-62
6-1	Site Plan, Site 2	6-2
6-2	Profile, Test Wells, Site 2	6-3

LIST OF FIGURES cont.

<u>Figure</u>		<u>Page</u>
6-3	Log of Test Well, Site 2	6-5
6-4	Chlorides - Reduction versus Travel Time	6-14
6-5	Chlorides - Percent Remaining of First Well Concentration	6-15
6-6	MBAS - Reduction Versus Travel Time	6-18
6-7	MBAS - Percent Remaining of First Well Concentration	6-19
6-8	Ammonia - Reduction Versus Travel Time	6-23
6-9	Ammonia - Percent Remaining of First Well Concentration	6-24
6-10	ABS In Use - Nitrogen Cycle Versus Travel Time	6-27
6-11	LAS In Use - Nitrogen Cycle Versus Travel Time	6-28
6-12	AS in Use - Nitrogen Cycle Versus Travel Time	6-29
6-13	Soap in Use - Nitrogen Cycle Versus Travel Time	6-30
6-14	LAS In Use - Nitrogen Cycle Versus Travel Time	6-31
6-15	Sucrose Ester in Use - Nitrogen Cycle Versus Travel Time	6-32
6-16	Sulfates - Reduction Versus Travel Time	6-36
6-17	Total Phosphates - Reduction Versus Travel Time	6-38
6-18	Total Phosphates - Percent Remaining of First Well Concentration	6-39
6-19	Log Average Coliforms - Reduction Versus Travel Time	6-41
6-20	Log Average Coliforms - Percent Remaining of First Well Concentration	6-42
6-21	Alkalinity - Reduction Versus Travel Time	6-45
6-22	Alkalinity - Percent Remaining of First Well Concentration	6-46

LIST OF FIGURES cont.

<u>Figure</u>		<u>Page</u>
6-23	Specific Conductance - Reduction Versus Travel Time	6-48
6-24	Specific Conductance - Percent Remaining of First Well Concentration	6-49
6-25	COD - Reduction Versus Travel Time	6-51
6-26	COD - Percent Remaining of First Well Concentration	6-52
6-27	ABS in Use - Reduction Versus Travel Time	6-57
6-28	ABS In Use - Percent Remaining of First Well Concentration	6-58
6-29	LAS In Use - Reduction Versus Travel Time	6-59
6-30	LAS In Use - Percent Remaining of First Well Concentration	6-60
6-31	AS In Use - Reduction Versus Travel Time	6-61
6-32	AS in Use - Percent Remaining of First Well Concentration	6-62
6-33	Soap In Use - Reduction Versus Travel Time	6-63
6-34	Soap In Use - Percent Remaining of First Well Concentration	6-64
6-35	LAS In Use - Reduction Versus Travel Time	6-65
6-36	LAS in Use - Percent Remaining of First Well Concentration	6-66
6-37	Sucrose Ester In Use - Reduction Versus Travel Time	6-67
6-38	Sucrose Ester In Use - Percent Remaining of First Well Concentration	6-68
7-1	Water Table Contours - Site 3	7-2
7-2	Plot Plan - Site 3	7-4
7-3	Well Location - Site 3	7-5
7-4	Well Profile - Site 3	7-6

LIST OF FIGURES cont.

<u>Figure</u>		<u>Page</u>
7-5	Sampling Pump	7-7
7-6	Cross Section - Cesspool and Shaft	7-9
7-7	Cross Section - Vacuum and Gravity Sampler	7-10
7-8	Sampler Tube Details	7-11
7-9	Neutron Probe Wells	7-15
7-10	Vertical and Horizontal Soil Moisture Content	7-16
7-11	Chlorides - Reduction Versus Travel Time	7-22
7-12	Chlorides - Percent Remaining of First Well Concentration	7-23
7-13	MBAS - Reduction Versus Travel Time	7-28
7-14	MBAS - Percent Remaining of First Well Concentration	7-29
7-15	Ammonia - Reduction Versus Time	7-45
7-16	Ammonia - Percent Remaining of First Well Concentration	7-46
7-17	ABS in Use - Nitrogen Cycle Versus Travel Time	7-47
7-18	ABS in Use - Nitrogen Cycle Versus Travel Time	7-48
7-19	LAS in Use - Nitrogen Cycle Versus Travel Time	7-49
7-20	Sulfates - Reduction Versus Travel Time	7-52
7-21	Phosphates - Reduction Versus Travel Time	7-55
7-22	Phosphates - Percent Remaining of First Well Concentration	7-56
7-23	Log Average Coliform Reduction Versus Travel Time	7-57
7-24	Log Average Coliform Percent Remaining of First Well Concentration	7-58
7-25	Alkalinity - Reduction Versus Travel Time	7-60
7-26	Alkalinity - Percent Remaining of First Well Concentration	7-61

LIST OF FIGURES cont.

<u>Figure</u>		<u>Page</u>
7-27	Specific Conductance - Reduction Versus Travel Time	7-63
7-28	Specific Conductance - Percent Remaining of First Well Concentration	7-64
7-29	COD - Reduction Versus Travel Time	7-66
7-30	COD - Percent Remaining of First Well Concentration	7-67
7-31	ABS in Use - Reduction Versus Travel Time	7-69
7-32	ABS In Use - Percent Remaining of First Well Concentration	7-70
7-33	LAS In Use - Reduction Versus Travel Time	7-71
7-34	LAS In Use - Percent Remaining of First Well Concentration	7-72
8-1	Site Plan - Site 4	8-2
8-2	Well Profile - Site 4	8-3
8-3	Chlorides - Reduction Versus Travel Time	8-9
8-4	Chlorides - Percent Remaining of First Well Concentration	8-10
8-5	MBAS - Reduction Versus Travel Time	8-12
8-6	Ammonia - Reduction Versus Travel Time	8-14
8-7	Nitrogen Cycle Versus Travel Time - Soap In Use	8-16
8-8	Nitrogen Cycle Versus Travel Time - LAS in Use	8-17
8-9	Sulfates - Reduction Versus Travel Time	8-19
8-10	Total Phosphates - Reduction Versus Travel Time	8-21
8-11	Log Average Coliform - Reduction Versus Travel Time	8-23
8-12	Alkalinity - Reduction Versus Travel Time	8-25
8-13	Specific Conductance - Reduction Versus Travel Time	8-27

LIST OF FIGURES cont.

<u>Figure</u>		<u>Page</u>
8-14	COD - Reduction Versus Travel Time	8-29
8-15	Soap In Use - Reduction Versus Travel Time	8-31
8-16	LAS In Use - Reduction Versus Travel Time	8-32
9-1	Site Plan, Site 5, Massepequa, Nassau County	9-3
9-2	Site Plan, Site 6, Bellmore, Nassau County	9-5
10-1	Cesspool Samples - Radioactive Tagging	10-22
10-2	Top Tensiometer Samples - Radioactive Tagging	10-23
10-3	Middle Gravity Long Samples - Radioactive Tagging	10-24
10-4	Well 6 Samples - Radioactive Tagging	10-25
10-5	Well 8 Samples - Radioactive Tagging	10-26
10-6	Wells 9 and 10 Samples - Radioactive Tagging	10-27
10-7	Well 13 Samples - Radioactive Tagging	10-28
10-8	Well 17 Samples - Radioactive Tagging	10-29
10-9	Cesspool Sample - Collected at Mid-Liquid Depth - Phase II	10-30
10-10	New Top Gravity Long Samples - Phase II	10-31
10-11	Middle Gravity Long Sample - Phase II	10-32
10-12	New Bottom Gravity Long - Phase II	10-33
10-13	Well 6 - Radioactive Tagging - Phase II	10-34
10-14	Wells 10 and 11 - Radioactive Tagging - Phase II	10-35
10-15	Wells 13 and 14 - Radioactive Tagging - Phase II	10-36
10-16	Test Shaft Results - Radioactive Tagging Phase II	10-37
10-17	Downstream Wells - Radioactive Tagging - Phase II	10-38

PHOTOGRAPHS

<u>Photo</u>		<u>Page</u>
4-1	Balling in Sampling Shaft Site 3	4-39
4-2	Well Points in Study	4-39
4-3	Collection of DO Samples From Modified Pump	4-40
4-4	Organization of Samples on Site for Split with Participating Laboratories	4-40

ABBREVIATIONS

ABS	alkyl benzene sulfonate
AS	alcohol sulfate
BOD	biochemical oxygen demand
COD	chemical oxygen demand
DO	dissolved oxygen
LAS	linear alkylate sulfonate
LAS ₁	initial use of LAS at test site
LAS ₂	second cycle of LAS use at test site
LOG Avg MPN/100 ml	logarithmic average most probable number per liter
MBAS	methylene blue active substance
MGD	millions of gallons per day
mg/l	milligrams per liter
MPN	most probable number
SCWA	Suffolk County Water Authority
SDMA	Soap and Detergent Manufacturers Association
SWL	static water level
TSCWRP	Temporary State Commission on Water Resources Planning
USGS	United States Geological Survey

PART I - CONCLUSIONS

General

The 1962 mandate of the New York State Legislature stipulated that the New York State Temporary Commission on Water Resources Planning investigate four basic considerations. The Long Island Research Project concerned itself with two of these considerations, namely:

1. "The dangers that such discharges (detergent wastes) may create to the adequacy and safety of the water supply now and in the future." and,
2. "If the area of contamination from detergent wastes is more widespread from the point of discharge than is usual in the cases of other forms of wastes."

The general conclusion of the Long Island Ground Water Pollution Study addressed to these basic considerations are as follows:

Some degree of degradation or other means of change - reduction of the active surfactants in the test products occurs in typical sewage disposal systems and the adjoining soil-water. The degree of degradation is deemed insufficient to prevent the contamination with synthetic detergents of the upper Glacial aquifer, now the major available source of individual water supply for homes, commercial establishments, and some public water supply wells in the Nassau-Suffolk area.

Detergents are the most persistent and most commonly found pollutant in the Glacial aquifer and the most frequent cause for rejection of Glacial wells as a source of water supply. Synthetic detergent residues, even when other sewage constituents are minimal, have forced public water purveyors to abandon or curtail their use and development of the Glacial aquifer. The restriction on use of this aquifer has immediate and far-reaching effects on the availability of water supply to present and future residents of the Nassau-Suffolk area, since

the Glacial aquifer is estimated to contain more than half of the locally available water source. All comprehensive planning reports on the Nassau-Suffolk area, especially those relating to safe yields of water supplies and the population that may be served from this limited resource, indicate that the Glacial aquifer must be utilized to serve present and future populations.

Relief from the contamination in the Glacial aquifer is secured by placing water supply wells in the deeper Magothy stratum. This procedure has been followed to a large extent but poses the risk of overdevelopment of the Magothy aquifer. Overpumping of this aquifer will result in the increased transfer of contamination from the overlying Glacial formation to the underlying aquifer, and may also induce greater salt water intrusion from surrounding waters into the fresh water resources of Long Island.

It is concluded that the MBAS fraction of synthetic detergents persists in quantities and travels distances sufficient to endanger the adequacy and quality of the water supply resources on Long Island and further, that these characteristics are more typical of detergent wastes than the other constituents in domestic sewage.

Attainment of Objectives of Project

The project sought knowledge on certain specific items and those are reported on in the order in which the items are listed under scope and objectives in the Introduction on page 3-14.

1. Techniques and methodology have been developed for the conduct of investigations of ground water contamination in unconsolidated geological formations. Most significant of these were pump modifications to collect D.O. samples, methods of collecting waste water from unsaturated sands, measurement of ground water movement and use of radioactive tracers. Details on specific techniques are contained in the body of the report.

2. The waste leaching from a cesspool moves essentially downward after entering the unsaturated soil. The wastes do not extend laterally more than two feet beyond the pool circumference.

Upon entering the saturated sands, the waste takes the form of a ribbon-like plume and moves with the prevailing ground water. In its travel, the waste is vertically depressed in the ground water table by factors relating to the nature of the subsoils, the relative density of the waste recharge phenomena, and influence of pumping wells in the vicinity.

3. Under the test conditions, no evidence was obtained which would indicate that the presence of methylene blue active substances cause bacteria and other sewage constituents to travel faster or further than they would in their absence. During the use of the various test detergents, a significant change in bacterial population was evident in the waste disposal systems. An increased disposal system population resulted in a greater migration of bacteria to the downstream test wells. Viable bacteria do pass through the unsaturated subsoils into the ground water table and travel downstream as a part of the waste.

4. The finer soils at Site 4 were the only subsoils significantly different from the material usually encountered in the Glacial formation in Nassau and Suffolk Counties. These finer soils contributed to higher reduction in MBAS materials, ammonia, sulfates, phosphates, alkalinity and specific conductance than other cesspool sites. Other variables were also present however to account for higher efficiencies at Site 4.

5. Typical Long Island Glacial soil does not have significant adsorptive capacities for ABS. Adsorption and desorption of the ABS molecule on the subsoils in situ was found, however, to be well defined for various surfactant formulations. This was best demonstrated by branch chained ABS retrieval from test wells even after the homeowner had been using soap for periods of 2 to 3 months, a

time lapse which was sufficient for complete passage of the waste slug at known movement rates. This was further confirmed by infrared differentiation analyses which indicated the retrieval of branched chain (ABS) materials long after the waste slug carrying the straight chain surfactants (LAS) had passed the observation wells.

6. Biodegradation of ABS in the anaerobic environment of subsurface waste disposal systems does not produce any significant reduction in the levels of MBAS or other sewage constituents in their passage from the system into the unsaturated or saturated subsoils.

Some degradation in terms of MBAS occurs in passage of the sewage effluent from the cesspool into the unsaturated soil zone of one. No significant reductions follow in further travel through the unsaturated zone and into and through the saturated soils.

Sucrose ester and soap have a relatively superior degradability than ABS, LAS and AS, on the basis of significantly larger reductions in chemical oxygen demand of sewage in passage through a subsurface disposal system and soil-water horizon. Lack of a MBAS fraction in these detergent products also obviates the need for degradability in terms of MBAS.

7. Phosphate reductions are rapid and almost total in the distances studied. Phosphate reductions parallel the coliform reduction curves. The nitrogen cycle proceeds at a rate dependent upon the availability of oxygen, length of travel through unsaturated soils, ground water velocity and in some cases the detergent formulation in use. Sulfate concentrations increase in passage through the zone of aeration and the saturated soil zone to a peak

value whereupon levels tend to decrease in further travel downgradient due primarily to dilution.

8. The tracer materials studied for measurement of ground water flow rates were hexavalent chromium, sodium fluoride, sodium chloride and tritium. Sodium chloride was found to be the most practical because of consistency of results, availability, ease of handling and analysis, non-toxicity and stability in the ground water environment.

Tritium and sodium fluoride give comparable velocities to those obtained by sodium chloride. These tracers are less desirable, because they require special handling and analysis, because of their toxicity and their susceptibility to interfering substances.

Hexavalent chromium proved to be very unsuitable as a tracer in that even the large concentrations which were introduced were not retrieved at short distances from the point of application.

9. A complex combination of physical, chemical, and biological phenomena occur from the entrance of domestic wastes into a subsurface disposal system, and through the system, the unsaturated soil and the saturated soil. Sorption, dilution, diffusion, chemical reaction, precipitation, filtration and biodegradation phenomena take place in varying degrees.

Improvement in efficiency of sewage treatment within the sewage disposal system may be achieved to a limited degree by research into optimum dimensions and arrangements. Reduction in sewage constituents within the soil-water horizon is a function of prevailing conditions and cannot be altered practically.

10. No specific tests were made of soil clogging and subsequent leaching system failure. It is believed that failures are primarily a function of the organic and particulate loadings on the soil caused by the sewage and the characteristics of the surrounding subsoil relating to interstitial size and availability of oxygen at the sewage-soil interface. On those sites where

system failure was imminent, relief was obtained by scouring the pool bottom with compressed air.

11. Individual subsurface sewage disposal systems provide insufficient treatment of wastes with the result that objectionable concentrations of sewage constituents, both biological and chemical, reach the water table. More sophisticated types of individual disposal systems, namely, septic tank in combination with leaching cesspools and septic tank in combination with leaching tile field systems, do not provide any significant improvement in the effluent quality compared to single cesspools.

12. Ground water is highly vulnerable to pollution by untreated sewage wastes and possesses poor recuperative capabilities. In the event that recharge of treated sewage effluents were to become a reality for water conservation practice, virtually complete treatment to drinking water standards will be necessary for almost all constituents to preserve the ground water quality. This is particularly true in the case of synthetic organic compounds, such as the refractory materials contained in synthetic detergents.

PART 2 - RECOMMENDATIONS

1. The ideal solution to the problem of continued contamination of the ground water resources of Long Island by synthetic detergents and other sewage constituents is the rapid installation of municipal sewage collection, treatment and disposal facilities in those areas in which discharges of insufficiently treated domestic sewage threaten the quality of the resource. Planning for municipal sewerage systems should be intensified in all areas of both counties. Further, every effort should be made to provide municipal sewerage service for all new homes. In those instances where a new community of homes is insufficient in number to successfully support a sewage treatment plant, procedures should be adopted to assure economies and homeowner acceptance of sewers when they do become available. Such measures should include construction of "dry" sewers where collection districts are established, provision of land area for future sewage treatment facilities, and setting aside of funds for future construction.

2. Notwithstanding all efforts to expedite the installation of public sewerage systems in Nassau and Suffolk Counties, a delay of many years must result before the completion of projects of the complexity and magnitude involved. In Nassau County approximately 25 percent of the area is now sewered and work has commenced on an additional 40 percent. The most optimistic predictions place completion of this 40 percent at 20 years and the remainder is unscheduled at this time. In Suffolk County less than 4 percent of the population is presently sewered. A comprehensive plan was prepared for the five western towns, an area of 566 square miles. It is improbable that this sewer construction can be completed even on a crash program in less than 30 years. It is therefore obvious that a substantial time period must elapse before sewer construction is advanced to the degree that adequate protection will be provided to the ground water resource.

Sufficient evidence is at hand to indicate that soap or a sucrose ester surfactant may be used as a general household detergent in the interim period until municipal sewerage is installed and thereby discontinue the incessant discharge of detergent products into the ground water. This would be best accomplished by a voluntary regional distribution of satisfactory detergent products by the industry. If such is not forthcoming, then legislative or other restrictive measures should be immediately employed to adequately regulate the use of detergents.

3. A continuous and vigilant program of ground water quality monitoring should be carried out by New York State and Nassau and Suffolk Counties. Such monitoring work will enable the two counties to evaluate and detect water quality deterioration in time to take whatever corrective action they deem necessary to protect their water supply resources in the public interest.

4. The soap and detergent industry should intensify research and development efforts to produce and market suitable synthetic detergent products which will biologically and/or chemically degrade under conditions existing in the admittedly ineffective sewage disposal systems now in use.

5. Studies should be made of the local applicability of more effective individual sewage disposal systems for use in new home construction in sparsely populated, remotely located areas to determine their effect on the overall ground water pollution problem.

6. Public water supply facilities should be extended to replace individual wells in populated areas.

PART 3 - INTRODUCTION TO PROJECT

Need for Research

1. Long Island geology and water resources.

Long Island is geologically a part of the Atlantic coastal plain, and on the basis of origin, age and structure is more directly related to the coastal regions of New Jersey than to the nearby areas in New York and New England.

Geologically, Long Island is composed of several distinct and identifiable formations of unconsolidated sand, gravel and clay laid down in more or less parallel beds on a hard bedrock surface. Because the rock floor of the island dips gently and uniformly in a southeasterly direction, the overlying unconsolidated materials are relatively thin along the north shore and thicken appreciably toward the Atlantic Ocean. These relations are shown in a general way in Figure 3-1. At some localities in the extreme western part of Long Island, the bedrock floor is only a few tens of feet below land surface and is actually exposed at the surface in some areas in Northwestern Queens County. However, in southeastern Suffolk County the bedrock floor is more than 2,000 feet below sea level.

The bedrock floor beneath Long Island is generally composed of the same types of rock that are exposed at many places on the nearby mainland. The bedrock floor is actually the deeply buried seaward extension of these inland rocks. In most areas the bedrock consists of schist and gneiss, although other types of rock have been encountered at places. The surface of the bedrock slopes in a southeasterly direction at the rate of about 60 to 80 feet per mile. Along the north shore of Suffolk County, such as at Lloyd Neck and Orient Point, the bedrock surface is about 500 to 600 feet below sea level. Along the south shore at the western tip of Fire Island, the bedrock lies more than 2,000 feet below sea level.

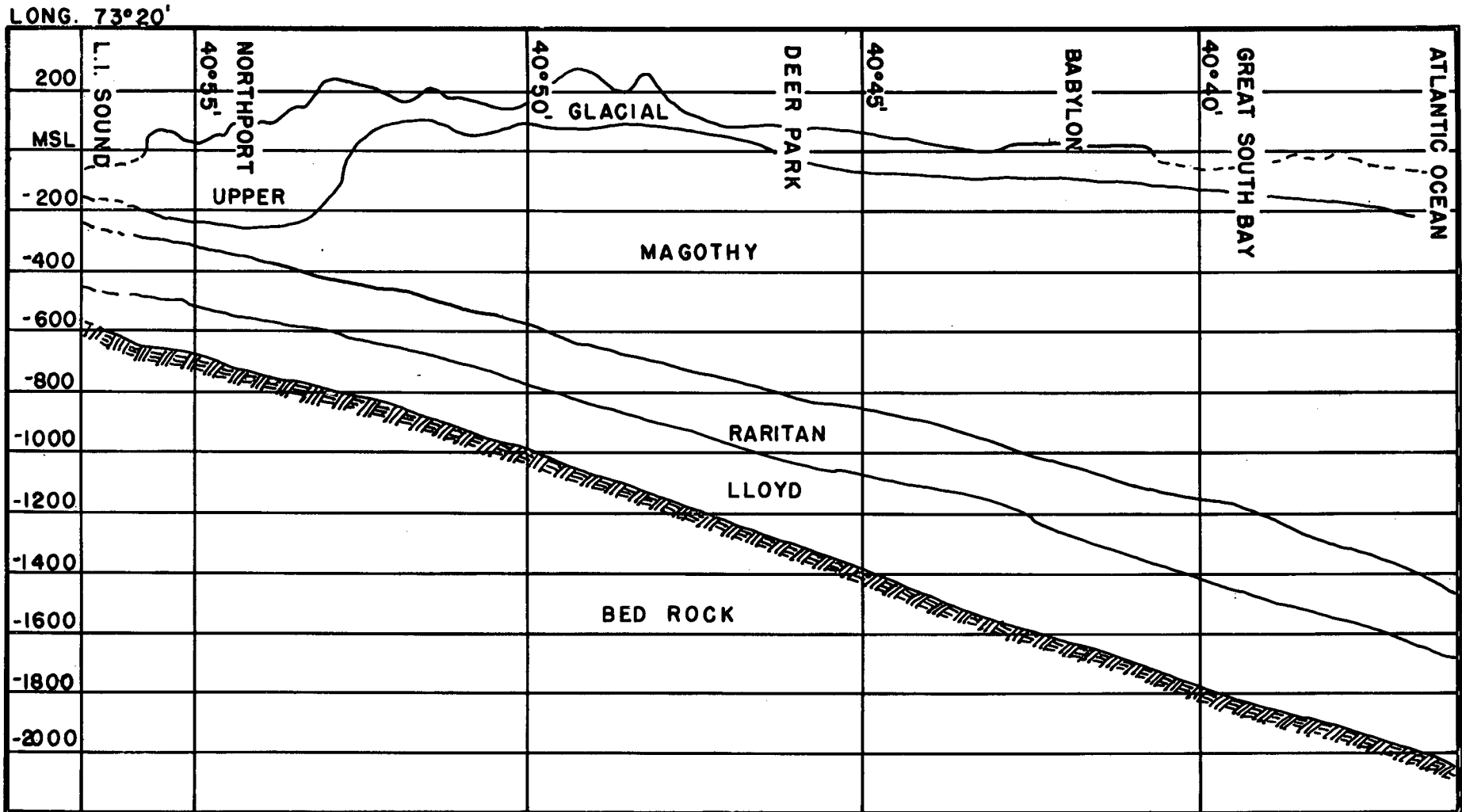

GENERALIZED CROSS SECTION
L. I. SOUND TO ATLANTIC OCEAN

The stratigraphic units underlying Long Island can generally be distinguished from each other on the basis of stratigraphic position, color and mineralogic composition. Other characteristics of the individual formations, such as lithologic make-up and permeability, are specially important from the ground water standpoint and play an important part in controlling the recharge, movement and discharge of ground water.

The Lloyd sand member of the Raritan formation, the lower most water-bearing unit, is composed mainly of white medium to coarse sands and gravels. The top of the Lloyd occurs at a depth ranging from about 200 feet below sea level along the north shore to approximately 1600 feet below sea level on the south shore. The total thickness ranges from about 100 feet in the north to more than 200 feet in the southern part of the Island.

Due to differences in elevation and a substantial thickness of overlying clay beds, the water in the Lloyd sand is under artesian pressure in much of the area of its occurrence. Apparently, the Lloyd is overlain everywhere in the two counties by the Raritan clay member of the Raritan formation, which separates the Lloyd from the shallower sands of the Magothy formation.

Due to its occurrence at generally great depths and the limited recharge, most of the production wells that obtain water from the Lloyd sand in the two counties are either located in the northern part where the formation is encountered at relatively shallow depths or in the southwesterly portion of Nassau County where salt water contamination has made the overlying formations unusable.

The Raritan clay member of the Raritan formation overlies the Lloyd sand. The Raritan clay is composed chiefly of silty clay with some interbedded layers of sand. Its thickness ranges from about 100 to 300 feet. Along the north shore the clay is encountered in depths of about 100 feet below sea level. To the south its maximum depth is estimated to be more than 1400 feet below sea level. Because the Raritan clay generally is highly impermeable, it forms a confining layer that produces artesian

conditions in the underlying Lloyd sand and limits the recharge of water into the aquifer.

The Raritan clay member is overlain by the Magothy formation, which is generally composed of irregular lens like beds of gravel, sand, sandy clay and clay. Most of these sediments are fine-grained and contain considerable amounts of mica and streaks of lignite. The individual beds in the formation generally do not have a wide lateral extent, and few of the beds have been correlated over distances of much more than a mile or two. However, deposits of coarse sand and gravel have been encountered near the bottom of the Magothy in many wells. The Magothy formation dips to the southeast and thickens in that direction. Along the south shore the Magothy is believed to be more than 1300 feet thick, although in some places along the north shore, it is less than a hundred feet thick. The elevation of the upper surface of the Magothy is highly irregular, indicating that the formation was subjected to considerable erosion before the deposition of the overlying materials.

In Nassau County more than 80 percent of the water supply is withdrawn from the Magothy formation. In Suffolk County, although the Magothy has a large ground water supply potential, it has not been extensively used because adequate yields could be obtained more cheaply from shallow wells screened in the overlying Glacial deposits. However, because of increasing pollution in the Glacial formation most new public water supply wells have been drilled into the Magothy formation in recent years. It is likely that this formation will more extensively developed in the future.

The Magothy formation is overlain by Glacial and interglacial deposits, that are quite variable in composition. The Gardiners clay has been identified in places near the bottom of the Glacial deposits, particularly along the south shore area and inland for several miles. The Gardiners clay generally consists of dark gray or greenish gray silty clay, although layers of sand are found in the unit in many places. The Gardiners clay is relatively impermeable and

generally forms an effective confining bed, which produces artesian conditions in the underlying sand.

The deposits above the Gardiners clay consist of Glacial till and Glacial outwash. The till, which generally occurs at the land surface or at shallow depths, is composed of a heterogeneous mixture of material ranging in size from clay to boulders. The moraines that extend eastward to Northern and Central Suffolk County to Montauk and Orient Point consist mainly of till. Beneath the till-covered area and exposed on the surface over much of the two counties, are deposits of stratified sand and gravel known as Glacial outwash. These outwash deposits are highly permeable and constitute the most readily available source of ground water supply. The water table or upper surface of the zone of saturation generally occurs in these deposits within a few tens of feet of the land surface, except in the areas of higher elevation.

As the two Glacial stages represented by the terminal moraine began to melt, an enormous quantity of water was made available, releasing with it great quantities of debris frozen in the ice. The melt water spread out to the south, not only reworking the existing ground cover, but also depositing the well-sorted stratified outwash deposit, the coarseness of the deposits being directly related to the velocity of water at that particular time and place. It is obvious that the quantity and velocity of the melt water could not be uniform all along the length or width of the outwash plain. It is therefore not surprising that the outwash varies in texture from place to place.

The outwash plains, having been built in this manner, containing well-rounded graded sands and gravel, and having been washed, sorted and stratified, yielded a deposit of high porosity and permeability, thus allowing water to enter and conversely be withdrawn with great facility. It is by reason of easily available water in large quantities and at shallow depth that the Glacial stratum is so feasible and economically attractive for exploitation.

Hydrology

Water supply for Long Island is obtained entirely from ground waters. Natural replenishment of this supply is derived solely from precipitation, which averages 42 inches per year. Due to losses from evaporation, transpiration, stream run-off and other factors, only part of the precipitation ever reaches the water-bearing strata. It has been estimated that approximately 50 percent of precipitation is lost due to the above-mentioned factors.

The water that infiltrates into the ground is either retained in the soil zone as soil moisture or passes downward to greater depths until it reaches the water table, where it becomes part of the main body of ground water.

When the recharge from rainfall infiltration reaches the water table, it percolates laterally at very low velocities in response to the slope of the water table. A portion of the total ground water recharge is disposed of by seepage into stream channels. This source of water, (ground water run-off), makes up a large part of the total flow of the streams in Long Island. It is estimated to be as high as 90 percent of all stream flow.

In the middle parts of the Island the piezometric surface of the Magothy and Lloyd formations have a lower elevation than that of the water table, recharge from the shallow Glacial formations takes place by slow downward percolation into the deeper formations. In areas where there is little or no pumping from wells, ground water levels are not depressed and the water table or the pressure gradient in the Magothy and Lloyd formations slope towards the shore areas, where discharge of fresh water takes place into the bays and in off-shore areas. However, in shore areas where heavy continuous pumping from wells is taking place, ground water levels are drawn down and the natural gradient toward the ocean may be reversed and salt water encroachment may take place.

Artificial recharging is extensively carried on in parts of Long Island

through storm run-off basins, subsurface sewage disposal facilities and other re-charging installations. All such operations maintain ground water levels at higher elevations than would otherwise exist. Because much of the water pumped from wells is returned to the ground, the consumptive use of water is much less than the total quantity of water pumped. In areas where the consumptive use of water is small, even though the total pumpage may be large, ground water levels may not decline appreciably, except locally near areas of heavy pumping. In the vicinity of the divide running laterally through Long Island, the ground water is approximately 60 to 80 feet above sea level, at its highest point along the ground water divide from which point the ground water table slopes generally north and south.

The ground water is moving continuously into and along the water-bearing strata, all of which are hydrologically interconnected. Its rate of movement depends upon the head of water and the transmissibility of the strata through which it flows. It is estimated to move at a rate which varies from 0.5 to 2.0 feet per day.

In Suffolk County, the most recent estimate of natural safe yield from the ground water reservoir is 501 MGD from a total effective area of 794 square miles. In Nassau County, the natural safe yield is estimated to be 154 MGD from a total effective area of 189 square miles.

History of Ground Water Pollution

The sewage disposal practices predominant in both Nassau and Suffolk Counties are primitive and obviously conducive to ground water contamination. In Nassau County, approximately 44 percent of the population is presently served by public sewage collection and disposal facilities serving approximately 630,000 persons. The construction of a major portion of these facilities was not initiated until 1947. The remaining 800,000 people in Nassau County dispose of their sewage through the use of subsurface disposal facilities, namely, cesspools. Plans are currently being prepared for public sewage collection and disposal facilities to serve another 560,000 people, and comprehensive studies are being conducted for the remaining areas.

The population of Suffolk County is approximately 1,000,000 persons. Only 5 percent of these million persons are served by public sewage collection and disposal facilities. The remaining 95 percent rely upon the use of subsurface sewage disposal facilities, such as cesspools, which discharge sanitary wastes directly into the ground water table or into the relatively shallow layer of overlying sand and gravels. A comprehensive sewerage plan has been prepared for the five western towns in which more than 75 percent of the population resides. A referendum in 1967 to authorize construction of a sewer district which would serve some 350,000 persons in the most densely populated area was defeated by a ratio of 6 to 1. There is no present indication that an abrupt change will take place in Suffolk's current methods of sewage disposal. It is estimated that Suffolk's population employs 250,000 individual subsurface disposal systems discharging 100 MGD of sewage into the ground water table via cesspools.

In both Nassau and Suffolk Counties, water is obtained entirely from the underlying ground water aquifers. In Nassau County, essentially all of the population is served by public water supply facilities. In Suffolk County approximately 70 percent of the population is served by public water supply, and the remaining 30 percent depends upon the use of individual wells located on each homeowner's plot. There are approximately 80,000 such private well water facilities.

In Nassau County, approximately 85 percent of the water supply wells are screened in the Magothy stratum. The remaining 15 percent of public water supply is obtained from Lloyd wells and some Glacial wells. Decades ago, most of Nassau's water supply was obtained from the readily available and highly productive Glacial stratum. However, the continual discharge of massive quantities of sewage into this uppermost stratum led to its gradual abandonment, and the use of the deeper Magothy stratum. In those areas in Nassau County in which sewers have been installed for some 15 to 20 years, there are indications that the quality of the Glacial is improving.

In Suffolk County, the Glacial stratum is the major source of both public and private water supplies. The current trend, however, is toward an increasing use of the Magothy stratum because of increasing pollution in the Glacial. In a 7-year period commencing in 1959, the Suffolk County Water Authority, the major water supplier operating in southwestern Suffolk, increased its Magothy withdrawals from 20 percent to 80 percent. In order to continue serving a water which meets the U.S. Public Health Service standards, it became necessary for the Authority to curtail withdrawals from the Glacial stratum because of increasing pollution.

Numerous reports by the Nassau and Suffolk County Health Departments and other official agencies, both State, Federal and County, have stressed the continuing and increasing appearance of ABS and other sewage-originated wastes in the Long Island ground waters. The problems have been most severe in the densely populated areas of the county but appear sporadically throughout the entire county. The greatest problems occur in those areas where homeowners must rely upon individual well water supplies. Surveys in such areas have shown 30 to 90 percent of the well water analyzed contained ABS and other sewage constituents. ABS is also detected in public water supply wells which obtain their water from the Glacial stratum in the heavily populated sections. The ABS contamination in these public supplies have exceeded the maximum permissible standards for ABS of 0.5 mg/l. Some public water supply wells examined have contained from 0.3 to 1.2 mg/l of ABS. To date, ABS has been detected in at least 7 wells in three public water supply systems. This has necessitated restricted pumping and/or discontinuance of the use of the water.

In addition, during the drought period of 1961 through 1965, the Suffolk County Water Authority detected trace quantities of synthetic detergents in

several of its upper Magothy wells in the center of the Island. The appearance of detergents in these deeper wells at these specific locations confirmed that the major areas of recharge to the Magothy are near the areas of maximum elevation of the static water table, under the present piezometric conditions.

The Nassau and Suffolk County Health Departments have carried out detailed surveys of private well water supplies in various areas in both counties. The results of some of these surveys are given below:

<u>Location</u>	<u>Number of Wells Examined</u>	<u>Percent Positive for ABS</u>
West Amityville	74	77%
Wantagh	18	67
Breezy Point, Amityville	55	40
Amityville Harbor	31	55
Copiague	186	32
North Lindenhurst	54	76
Babylon	20	95
West Islip	16	75
West Islip	100	30
West Islip	45	25
Center Moriches	65	30
Nassau Shore, Massapequa	78	81

In the Copiague areas 186 wells were examined, and a detailed report was prepared by the Suffolk County Health Department. In this survey, complete chemical analyses and the bacteriological analyses were made of all samples, and 32 percent of the wells examined failed to meet drinking water standards. Cooperative action between the community, Suffolk County Water Authority and Suffolk County Health Department resulted in extension of public water supply into the affected area.

A survey conducted in October 1958 in North Lindenhurst revealed presence of ABS in 41 of 54 wells sampled. In November 1959, these wells were resampled to determine what changes had taken place in the intervening 13 months. The results of the resurvey indicated:

1. Of the original 34 wells which contained ABS, two were equal in ABS content to the previous year's results.
 2. Two wells had decreased in ABS content.
 3. Thirty of the wells had increased in ABS content. Of this group, 10 had doubled and 6 had tripled in ABS levels.
 4. The initial ABS range in the October 1958 survey was 0.5 to 1.5 milligrams per liter, and two samples exceeded 1.5 milligrams per liter.
 5. The range for the November 1959 survey was 0.5 mg/l to 4.5 mg/l, and of the total, 13 exceeded 1.5 mg/l. Seven of the 13 exceeded 2.0 mg/l.
- When these wells were tested, if the results of the ABS analysis, which was less than .5 mg/l, the well was considered to be free of ABS.
- This conclusion was based upon the assumption that the ABS test at that time was accurate only for 0.5 mg/l or higher.

In all of the above surveys, complete analysis of the well waters indicated the presence of other sewage-associated constituents. In addition to ABS, all analyses showed excessive quantities of nitrates, free ammonias, alkalinity, chlorides, phosphates, COD and total dissolved solids. Bacteriological examinations showed the presence of the coliform organism in several instances.

A research project which investigated the effect of launderette wastes upon the ground water travel was carried out under a research grant from the New York State Health Department. The results of the project were reported upon in Research Report No. 6 by the Suffolk County Health Department and C.W. Lauman Company. In essence the project indicated that launderette wastes in one area traveled for a distance of 1,000 feet and descended to a depth of 100 feet. The descent of the wastes was halted

by extensive clay lens.

The water quality of south shore streams is indicative of the general water quality of the upper Glacial aquifer, as the base flow of most of these streams is the water from this aquifer. Therefore, a monitoring of the past and present quality of these waters is an ideal indicator of quality trends. A review of the data from 1962 to 1967 shows the detergent levels in the streams in the following towns have increased as follows:

- | | |
|---------------|------|
| 1. Babylon | 133% |
| 2. Islip | 265% |
| 3. Brookhaven | 188% |

In three of eleven streams sampled in the Town of Babylon in 1962 maximum concentrations of detergents exceeded the allowable concentration in drinking water. By 1967 every one of twelve streams had concentrations which exceeded the drinking water standards. Sampling of the streams indicated a definite increase in detergent concentration in an east to west direction, the obvious inference being that the greater the population the greater the pollution.

Legislative Action

Private and public concern with the increasing contamination of water supply sources by ABS brought the problem into such prominence that legislative action was deemed necessary.

In the 1962 session of the New York State Legislature, the Senate and Assembly, with the approval of Governor Rockefeller, mandated the Temporary State Commission on Water Resources Planning to make a study of the detergent problem. The instructions to the Commission are expressed in the following terms:

"The Commission shall undertake an investigation and careful study of the effects of and the problems arising from the underground discharge of wastes containing detergents upon the ground water supply of Long Island, the only source of supply available to that area of the State outside the limits of the City of New York. The Commission

shall consider the effects of the continually increasing discharge of detergents into the underground upon the health, safety and welfare of the present and future population and the dangers that such discharges of waste may create to the adequacy and safety of the water supply now and in the future. The Commission shall ascertain if the area of contamination from detergent wastes is more widespread from the point of discharge than is usual in the cases of other forms of wastes. The Commission shall ascertain if similar conditions exist in other areas of the State."

An early examination into the problem by the Commission indicated that:

1. The problem was not peculiar to New York State.
2. Studies had been undertaken by many technical agencies here and abroad for many years and a considerable fund of information was already available as background for the New York State investigations.
3. These data, valuable though they are, could not eliminate the necessity to study water conditions in Long Island and elsewhere in the State under the actual conditions existing in New York.
4. Every principal source of information, knowledge and experience had to be enlisted into service in order to provide authentic findings and the best possible solutions to the pressing problems.

The task groups were integrated into a single technical guidance unit because of the interlocking details of the various studies. Repeated conference meetings were held by the joint groups to plan the progress of field studies and to evaluate findings in terms of their effect on next-step planning of the studies.

The Suffolk-Nassau County field investigation task unit, after conferences amongst its members, prepared a justification and procedure report outlining the areas in which additional information was required and presented test procedures by which such information might be obtained. The report is given below:

Scope and Objectives of Project

1. There will be developed a technique and methodology for studies of this nature. There are techniques of analysis, collection of samples, placement of test wells and other procedures which must be or will be developed in carrying out this project. The information and techniques acquired in the conduct of the project will most certainly contribute to the methodology necessary to carry out such investigations.
2. Additional information will be obtained relative to the horizontal and vertical rates of percolation and direction of flow of levels of ABS and other wastes while traveling through saturated and unsaturated subsoils.
3. Additional information will be obtained relative to the effect of ABS on the travel of other wastes, including bacteria when present with ABS in the saturated and unsaturated subsoils.
4. The effect on ABS and other waste materials brought about by varying subsoils in the zone of aeration and in the saturated subsoils.
5. Additional information will be obtained relative to adsorption of ABS by the various subsoils which are predominant in the Long Island area.
6. Increased knowledge on the phenomena of biochemical degradation of ABS and other waste in saturated and unsaturated soils, in addition to information on the relative biodegradability of alternate surfactants.

7. Variations in the amounts of nitrogen, sulphur, and phosphate compounds in saturated and unsaturated soils and under aerobic and anaerobic conditions.
8. The development of suitable tracers for the study of the movements of wastes into and through the ground waters.
9. Additional information on the mechanisms of how ground water contamination comes about and suggested methods of control. This will also demonstrate long-term and short-term effects of liquid and solid waste disposal methods in ground water areas.
10. Through the study of the waste disposal units involved, it is believed some additional interpretative data may be obtained relative to the mechanics of soil clogging.
11. Knowledge will be obtained relative to the effectiveness of the predominant individual sewage disposal systems in reduction of wastes prior to their discharge into ground water.
12. In addition to the applicability of the knowledges gained about the problems of water supply, this information will also serve as a guide to the return of treated sewage to the ground waters.

Authorization for Project

State Health Department Contract.

In 1963 a contract was established with the State Health Department in order to carry out the proposed field study in Nassau and Suffolk Counties. The participants in the contract were the New York State Health Department, the Nassau County Health Department, the Suffolk County Health

Department, the Suffolk County Water Authority and C.W. Lauman & Company. The Nassau and Suffolk County Health Departments were to furnish field personnel for conducting tests and collection of samples and recording of data. Laboratory services were provided by the laboratories of the New York State Health Department and Nassau County Health Department, Suffolk County Water Authority and Lauman Laboratories. C. W. Lauman and Company were to install the necessary test well equipment. The contract was established in the sum of \$30,000. The Temporary Water Resources Commission, its staff and engineering consultant functioned as the base from which all operations were carried out. Conferences and meetings sponsored by the Commission provided for periodic review of the project and its findings.

As the project progressed, the concept evolved of sampling the cesspool discharge as it passed through the unsaturated soils above the ground water table. In order to do so, it was necessary to install a concrete shaft and sampling devices parallel to and below the cesspool. A contract (\$12,000) to construct the shaft and install the sampling devices was established between the New York State Health Department and C. W. Lauman Company and funded by a U.S. Public Health Service Grant.

Organization of Study Groups

The Commission convened an exploratory conference on the detergent problem in May 1962. It invited to the conference persons and agencies interested in the detergent problems including Suffolk and Nassau County officials, State Departments and agencies, legislators, civic leaders, Public Health Service, U.S. Geological Survey, Associated Industries of New York State, the Soap and Detergent Association and others.

Following the conference, Senator Van Lare created an Advisory Group on the detergent problem. From the Advisory Group, were appointed five

technical units in the form of Ad Hoc Groups:

1. Technical Advisory Group on the Long Island Studies - Dr. Morris Cohn, Chairman.
2. Nassau-Suffolk Research Task Group - John Flynn and Francis Padar Co-Chairmen.
3. Upstate Study Group - Dr. Nelson Nemerow, Chairman.
4. Detergent Test Products Group - E. Scott Pattison, Chairman.
5. Blueprint of Action Group - Dr. Meredith Thompson, Chairman.

The makeup of the major groups and the names of the members are listed below:

SPECIAL ADVISORY GROUP FOR THE STUDY OF THE
DETERGENT POLLUTION PROBLEM

Senator Frank E. Van Lare, Chairman, 1962-1965, Temporary State Commission on Water Resources Planning

Assemblyman Alonzo L. Waters, Vice Chairman, 1962-1965, Temporary State Commission on Water Resources Planning

Assemblyman Albert J. Hausbeck, Chairman, 1965-1967, Temporary State Commission on Water Resources Planning

Senator Irving Mosberg, Vice Chairman, 1965-1967, Temporary State Commission on Water Resources Planning

*Barry D. Andres, Director, Lauman Laboratories

*T.W. Bendixen, U.S. Public Health Service

E.W. Blank, Colgate-Palmolive Company

*Theodore E. Brenner, Soap and Detergent Association

*Charles G. Buelتمان, Soap and Detergent Association

John J. Burns, Commissioner, Office for Local Government, New York State

Herbert W. Davids, P.E., Director of Environmental Health Services, Suffolk County Department of Health

Nathan Fenn, P.E., Manager, Suffolk County Water Authority

*John M. Flynn, P.E., Associate Public Health Engineer, Suffolk County Department of Health

*William F. Graner, P.E., Senior Public Health Engineer, Suffolk County
Department of Health

Dr. C.S. Grove, Jr., Prof. of Engineering, Syracuse University, L.C.
Smith College of Engineering

*August A. Guerrera, Suffolk County Water Authority

James C. Harding, P.E., Commissioner, Westchester County Department of
Public Works

W.L. Jensen, Continental Oil Company

*Al Jung, Division of Laboratories and Research, New York State Depart-
ment of Health

Dr. Joseph H. Kinnaman, Commissioner, Nassau County Department of Health

*Lee E. Koppelman, Director of Planning, Suffolk County Department of
Planning

*Vincent Lamberti, Lever Brothers

*Herman E. Lauman, President, C.W. Lauman and Company

Dr. George E. Leone, Commissioner of Health, Suffolk County Department
of Health

*Maxim Lieber, Assistant Director, Division of Laboratories and Research,
Nassau County Department of Health

*Roy Martin, U.S. Public Health Service, 42 Broadway, New York City

Sylvan C. Martin, Sanitary Engineer Director, U.S. Public Health Service

James H. McDermott, Sanitary Engineer, U.S. Public Health Service

H.V. Moss, Monsanto Chemical Company

George J. Natt, Director, Westchester County Water Agency

Professor Nelson F. Nemerow, Syracuse University, L.C. Smith College of
Engineering

J.E. O'Brien, Division of Laboratories and Research, New York State De-
partment of Health

*Francis V. Padar, P.E., Executive Director, Environmental Health, Nassau
County Department of Health

*E. Scott Pattison, Manager, The Soap and Detergent Association

*Nathaniel M. Perlmutter, Geologist, U.S. Geological Survey

*Allan Raymond, Senior Sanitary Engineer, New York State Department of Health

Joseph R. Shaw, President, Associated Industries of New York State, Inc.

D.F. Searle, California Research Company

*Donald B. Stevens, P.E., State Department of Health

George H. Sumner, P.E., Assistant Commissioner of Environmental Health
Nassau County Department of Health

Dr. Meredith H. Thompson, Assistant Commissioner, Division of Environmental Health Services, State Department of Health

J. Turck, Jr., Fels and Company

*Arthur Warner, P.E., State Department of Health

*P.J. Weaver, Proctor and Gamble Company

R. Stewart Kilborne, Commissioner, Department of Conservation, New York State

Harold J. Wilm, Former Commissioner, Department of Conservation, New York State

Michael Zihal, P.E., Assistant General Manager, Long Island Water Company

TECHNICAL ADVISOR

*Dr. Morris M. Cohn, Engineering Consultant, Coordinator of Studies

*Technical Advisory Group on Long Island Study

NASSAU-SUFFOLK RESEARCH TASK GROUP

John M. Flynn, P.E., Associate Public Health Engineer, Suffolk County Department of Health - Chairman

Francis V. Padar, P.E., Executive Director, Environmental Health, Nassau County Department of Health - Co-Chairman

Barry D. Andres, Director, Lauman Laboratories

William F. Graner, P.E., Senior Public Health Engineer, Suffolk County Department of Health

August A. Guerrero, Chief Chemist, Suffolk County Water Authority

Field personnel

Donald G. Gallerani, Sanitarian, Suffolk County Department of Health

Robert Sheppard, Sanitarian, Suffolk County Department of Health

Fred L. Nuhn, Sanitarian, Nassau County Department of Health

Eugene Walker, Sanitarian, Nassau County Department of Health

Gerard T. Nelson, Sanitarian, Nassau County Department of Health

Douglas F. Wilcox, Sanitarian, Nassau County Department of Health

Charles Philbrick, Sanitarian, Nassau County Department of Health

Eric Kittler, Chemist, Suffolk County Water Authority

Description of Research Procedure

Site Selection

1. Plot Size - The sites selected varied from 10,000 square feet to 2 acres. In order to minimize interference from off-site pollution, every attempt was made to select the largest plot size available in the problem area.
2. Family Size - The homes selected contained a typical size family, preferably one with two or three younger children. The homeowner was questioned relative to any proposed sale of the home or longterm vacation, which would affect the continuity of the project.
3. Water Usage - The homes selected had minimum water use of 250 gallons per day.

A total of 52 individual home sites were surveyed in order to locate sites on which to conduct the research project.

When a site was selected as suitable, a contract was drawn between the property owner and the Temporary New York State Water Resources Commission. The homeowner agreed to participate in the project and cooperate in the use of the detergent test products. The Commission in turn agreed to restore the property to its previous condition upon completion of the project.

4. Age of Home and Facilities - The home selected was generally within the 3 to 5-year old range with sewage and water supply facilities

approximately the same age. Site No. 6, however, was occupied for only 4 months preceding its selection as a site.

5. Location and Direction of Adjacent Homes and Water and Sewage Facilities - Every effort was made to minimize background interference due to upstream sewage disposal or water supply facilities. Areas in the vicinity of large public or private water supply wells were avoided in order to offset ground water flow changes due to heavy pumpage.
6. Area Plot Density - Areas with high plot densities were avoided in order to offset interference from upstream pollution due to subsurface sewage discharges.
7. Public Water Supply Versus Private Water Supply - Preference was given to sites supplied by public water without sacrificing a good private water supply site. This was believed to be advisable, since it permitted a less restricted use of tracer or dosing materials in that there was no need to be concerned with their effect upon the homeowners' individual well or neighboring wells.
8. Specific Site Data - The following specific data was obtained on each site:
 - a. Detailed plot plan.
 - b. Type and location of sewage disposal systems.
 - c. Consideration was given to installation of a completely new sewage disposal system on at least one site in order to obtain information on the function of new disposal systems in relation to older systems. This proposal was not carried out, since it was the consensus opinion that steady-state conditions were the prime concern.
 - d. Sites on which separate disposal systems for laundry wastes were constructed were rejected.

- e. On sites employing individual wells, the depth, diameter, and location of wells were plotted. Plots with lawn sprinkler systems and/or irrigation wells were rejected.
- f. It was necessary that the site be readily accessible for the entrance of well drilling rigs and accompanying trucks. The presence of large trees, outbuildings and other obstructions on the flow line were caused for rejection of the site.
- g. Families employing anionic detergents were preferred in order that significant ABS values could be found.

Description of Types of Cases

- 1. Case I - The following types of sites were sought out.
 - a. Depth to Ground Water - 4 to 6 feet to static water level.
 - b. Subsoil
 - 1. Medium to coarse sand and gravel.
 - 2. Fine silty sands.
 - c. Sewage Disposal System
 - 1. Septic tank and seepage field.
 - 2. Shallow leaching pool.
 - d. Number of Sites - It was proposed to carry out the testing procedure for each type of disposal system in each of the subsoil areas described. This would give a total of 4 sites.
- 2. Case II
 - a. Depth to Ground Water - 15 to 20 feet static water level.
 - b. Subsoil - In this ground water level range, the predominant subsoil is a medium sand and gravel.
 - c. Sewage Disposal System - The predominant type of disposal system under this case consists of one or two leaching pools.
 - d. Number of Sites - Two disposal systems will be investigated under the

predominant subsoil. This would give a total of two sites.

3. Case III

- a. Depth to Ground Water - 40 feet to static water level.
- b. Subsoil - Two types of subsoil predominate.
 1. Medium sands and gravel.
 2. Fine silty sands with traces of clay.
- c. Sewage Disposal System - The predominant type of disposal system under this case consists of one or two leaching pools.
- d. Number of Sites - Each of the predominant subsoils were to be investigated. This would give a total of two sites.

The type and number of sites which were selected are listed below and in Figure 3-2.

Case I

Site No. 1

Medium sand, 8 feet to ground water, 2 cesspools.

Site No. 2

Medium sand, 8 feet to ground water, septic tank and 1 cesspool.

Site Nos. 5 & 6

Medium sand, 4.5 and 8 feet respectively to ground water, septic tank and seepage field.

Case II

Site No. 4

Fine-medium sand, 17 feet to ground water, two cesspools.

Case III

Site No. 3

Medium sand, 30 feet to ground water, 1 cesspool.

Chemical Analyses

Although Chapter 530 of the Laws of 1962 mandated the T.S.C.W.R.P. to consider only "the effects of the...discharge of detergents into underground waters", the Task Group

LONG ISLAND GROUND WATER POLLUTION STUDY
SITE LOCATIONS

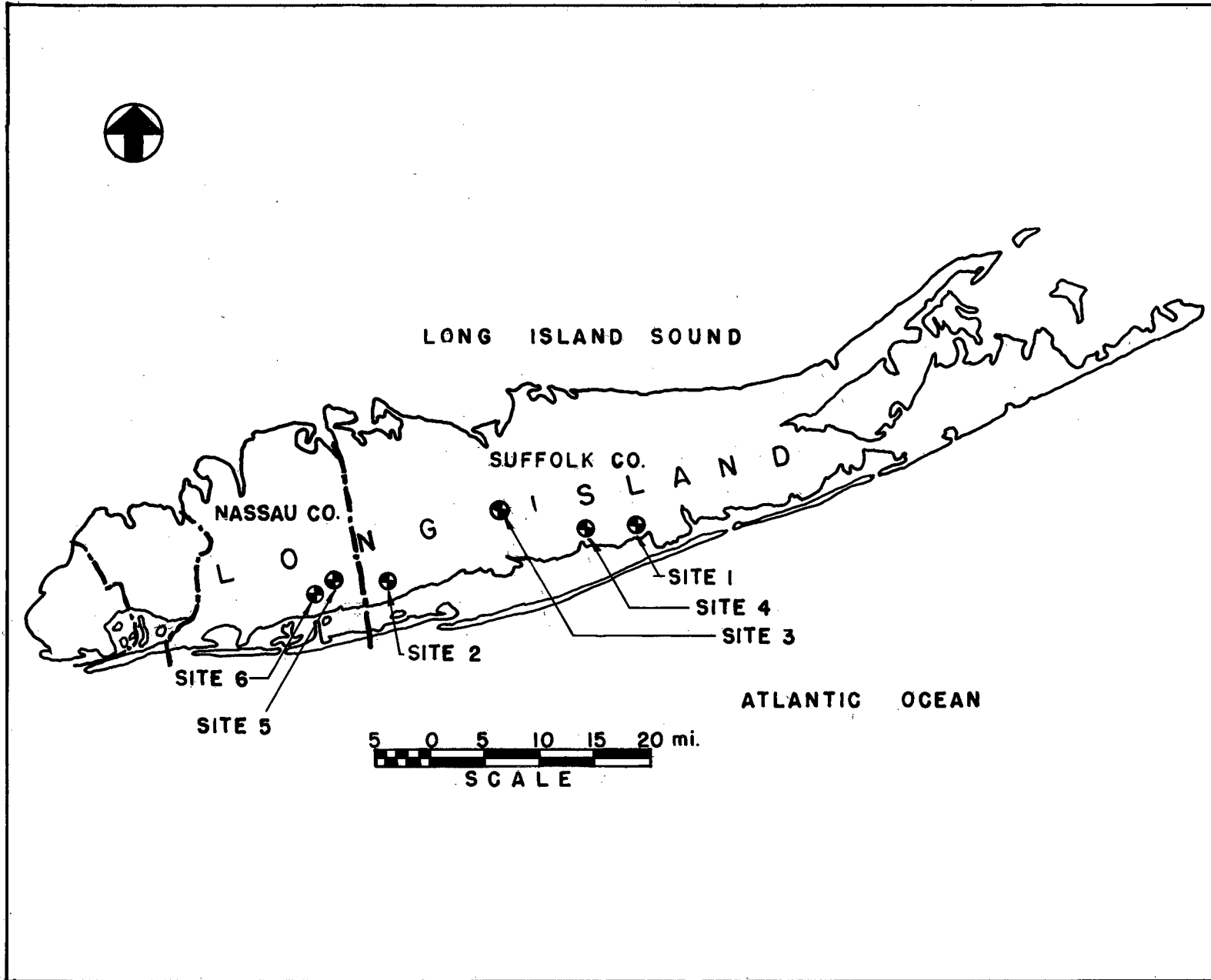

3-24

FIG. 3-2

agreed that it would be desirable to monitor as many constituents of ground water and sewage as possible. Accordingly, the following analyses were performed:

1. Surfactants - Methylene Blue Active Substances were determined according to procedures in "Standard Methods". This determination was made on all samples received, recognizing that samples containing LAS & AS would not correlate exactly to the calibration curves prepared using ABS and that soap was not methylene blue active. Analyses were performed by the Suffolk County Water Authority Laboratory at Oakdale. In addition, member firms of the Soap and Detergent Association made determinations by infrared procedures, both as a referee method and to differentiate between ABS and LAS.
2. Chlorides - This determination was made on all samples of water and sewage received. Results were useful in estimating dilution factors when wastes reached the water table. Analyses were performed by standard wet methods and also by automated equipment at the State Department of Health.
3. Chemical Oxygen Demand - A measure of the quantity of oxidizable compounds was determined. Samples were screened to minimize the number of analyses necessary as laboratory facilities were limited. The Soap & Detergent Association assisted in contracting with an independent laboratory for COD determinations.
4. Nitrogen Cycle Constituents - Free ammonia, nitrites and nitrates were determined using automated equipment by the New York State Department of Health, Division of Laboratories and Research. Samples were screened by Lauman Laboratories and those containing less than 0.1 mg/l were analyzed by distillation procedures.
5. Sulfates - This determination was made by the Nassau County Health Department Laboratory on each sample. Although of limited sanitary

significance, sulfate data also served as a measure of dilution.

6. Total Alkalinity - This determination was made by the Suffolk County Water Authority Laboratory on each sample. Measuring the combined effects of carbonates, bicarbonates and hydroxides, alkalinity is loosely related to pH. Since background levels in uncontaminated Long Island ground water are generally less than 20 mg/l and levels of 400-500 common in wastes, it was useful in locating the slug of waste.
7. pH was determined potentiometrically in the SCWA Laboratory, being the nearest agency to most of the sites.
8. Phosphates - Total and orthophosphates were determined by Nassau County Health Department Laboratory on each sample.
9. Dissolved Oxygen - This determination was made on those sites where samples could be collected without the entrainment of air. A specially designed pumping arrangement described elsewhere was successful to the extent that it was able to retrieve samples with zero dissolved oxygen. Figure 3-3
10. Specific Conductance was determined on most samples as a quick method for measuring the ion concentration of water.

Bacteriological Analyses

1. Coliform Group - Bacteriological examinations for members of the Coliform Group were made at the Nassau County Health Department Laboratory using the lactose broth-brilliant green bile multiple tube fermentation technique. Plate counts at 35°C were also made. On selected samples, differential determinations were made to demonstrate probable origin of the organism. Standard Methods IMVIC procedure utilizing indole, methyl red Voges-Proskauer and sodium citrate media were employed to indicate whether the coliform

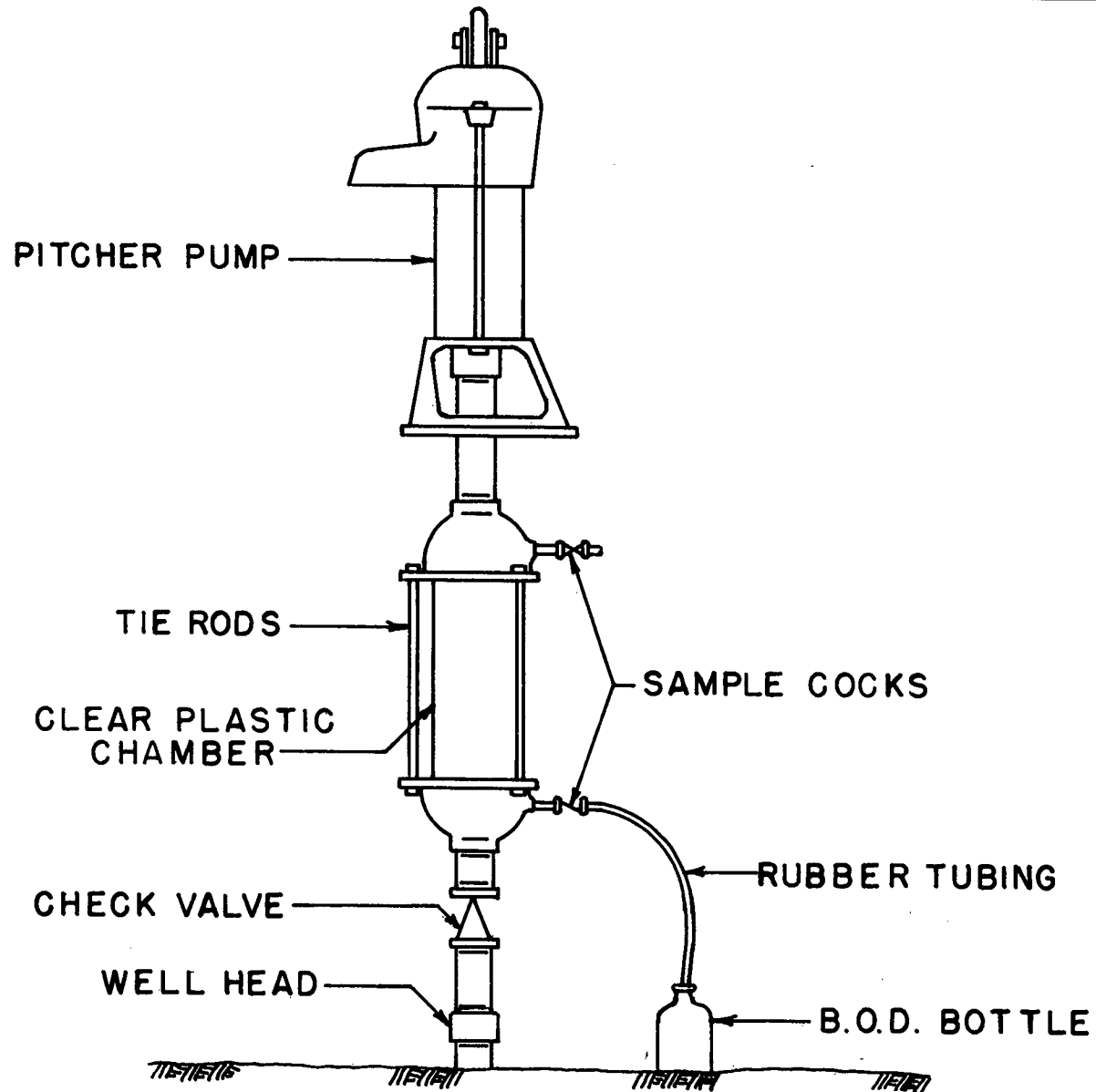

LONG ISLAND GROUND WATER POLLUTION STUDY
SAMPLING PUMP

detected were of fecal origin. There were special problems involved in the collection of reliable representative samples for bacteriological analyses from the test wells. The methods of pumping and collection required special procedures to avoid cross contamination. The feasibility of the disinfection procedures evolved were evaluated on the first site, and the results indicated that the technique warranted continuing the practice for all sites.

2. Viruses - Cloth swabs sampling the contents of the cesspool and certain wells at Site 1 were submitted for virus examination. The cursory sampling program did not reveal the presence of pathogenic enteric viruses, such as ECHO or coxsackie which may be present in sewage since they do not appear in human stools. The absence of placques may be attributed in part to the season of the year in which they were collected.

Analysis of Sewage

1. Frequency of Analysis - A series of samples were collected to determine the average strength of the sewage constituents. In addition, periodic samples were collected in order to detect variations in the sewage strength.
2. Analyses - The sewage was tested for all the constituents tested for in the test well waters. In addition, determinations were made for BOD and total solids.

Collection of Samples and Frequency of Analysis

1. Sampling Frequency - Initially, the minimum sampling frequency was one sample per test well per week. Experience of the first site indicated that bi-weekly sampling was sufficient.
2. Methods for Collection of Samples

- a. Saturated Soils - Test wells with screens located in saturated soils were pumped for sampling by a pitcher pump when static water level was within 25 feet of existing grade. When the depth to static water level exceeded 25 feet, water for samples was pumped by use of hand-operated rod pumps and an electric vacuum pump. (Drawing III-8)

Prior to collection of the water to be analyzed, each well was pumped for sufficient time to clear the well casing. Special attention was given to see that wells were not overpumped, thereby giving samples which were not representative of the stratum being tested. Two-gallon samples were pumped from each well.

- b. Unsaturated Soils - The collection of samples from the unsaturated soils required special techniques and is discussed under the details on Site No. 3.

Detergent Compounds

1. Types of Detergents Evaluated - The member firms of the Soap & Detergent Association cooperatively formulated test products containing 4 types of surfactants, and the Sugar Research Foundation supplied a fifth compound prepared from sucrose esters. The washing products were packaged in plain white 20 oz. boxes labeled "Household Detergent" and "Prepared and Packed for Temporary New York State Commission on Water Resources Planning, Albany, N.Y.... in connection with research studies of water resources in New York State...". The packages, except for sucrose ester, were coded with black squares on the bottom surface according to the following formulations:

ABS	Branched chain ABS	25%
	Phosphate builder	44%
	Misc. builders & minor ingred.	31%
LAS	Straight chain ABS	26%
	Phosphate builders	45%
	Misc. builders & minor ingred.	29%

AS	Sodium coco Alcohol Sulfate	9%
	Sodium Tallow Alcohol Sulfate	9%
	Phosphate builders	50%
	Misc. builders & minor ingred.	32%
Soap	Coconut oil tallow and tall oil soap	60%
	Phosphate builders	12%
Sucrose Ester	Misc. builders & minor ingred.	28%
	Sod. Silicate	6%
	Sod. Phosphate	40%
	Sucrose Ester	10%
	CM Cellulose	1%
	Opt. Brightener	0.1%
	Perfume Oil	0.1%
	Sod. Sulfate	43%

It should be made clear that the above materials were prepared specifically for use in the Long Island detergent studies and should not be considered commercial products.

2. Quantity Per Home - The Soap & Detergent Association supplied sufficient detergent products to provide four 20-ounce packages per week to each test site home. The quantity actually consumed was variable depending on the size and habits of the family.
3. Direction for Use - The Association furnished printed direction sheets advising on recommended quantities for clothes and dishwashing, and also suggested the products be used for general cleaning. No restrictions were considered necessary on the use

of scouring powders, shampoos or compounds for automatic dishwashers.

The homeowners were requested to use the products supplied exclusively, keep records of the amounts consumed, and were not advised as to which product they were using.

4. Length of Use - Product use of a specific formulation was continued for a sufficient time to establish a stable or equilibrium condition in the disposal system and/or observation wells as indicated by sample results.

Soil Analysis

A core sample was obtained on each site. The soils were examined for each change of soil and at 5-foot intervals. Borings extended at least 30 feet into ground water.

The core analysis was the first investigation made at each site in order to determine the suitability of the site for the test project. Where core analysis revealed impervious soils, the site was rejected. Tests were conducted on the soils removed to determine uniformity coefficient and effective size.

Site Procedure

The search for appropriate test sites was commenced by forwarding a circular to employees of the Health Departments in Nassau and Suffolk Counties and the Suffolk County Water Authority. It was believed that employees of these agencies would be sympathetic to the project and willing to participate. Approximately 15 individuals volunteered the use of their properties. The generalized procedure followed is described below:

1. After screening from the site survey data sheet, the members of the Research Committee visited the site in order to make final determinations relative to its selection.

2. After selection of a tentative site, engineers from the Health Departments made ground surveys to locate the buildings and establish contour lines.
3. After location of the disposal system, an estimated ground water flow line was laid out across the center of the disposal system. The ground water flow direction was determined by the installation of test wells in the vicinity of the site. The elevation of the ground water in the test wells was plotted and ground water contour lines drawn. The ground water flow direction is perpendicular to the ground water contour lines. When this direction was determined, a line paralleling the ground water flow was placed through the center of the disposal system.
4. A core hole was drilled in the vicinity of the disposal unit. The core was carried through the unsaturated sands and a minimum of 30 feet into the saturated sands. The core was visually inspected in order to determine subsoil conditions. On the sites which were selected, the subsoils consisted of sands and gravels through the entire depth. The presence of a substantial lens of clay or other impervious materials in the test site subsoils caused rejection of the site.
5. At a distance of approximately 25 feet from the center of the disposal system and downstream in the ground water flow direction, probe wells were installed. The probe well was introduced into the ground water table at depths of 1, 2, 4 and 6 feet below static water level. The probe was pumped at each of these levels, and a field analysis was made for ABS. In those instances where the ground water direction flow had been accurately determined, ABS contents at various depths made it possible to locate the

main body of the sewage slug. If the first probe well missed the slug, additional probes were installed at varying horizontal distances from the estimated ground water flow direction line. The same procedures of pumping at various depths in the ground water table were followed until the sewage slug was located.

6. When depth and direction of the slug was determined, the test wells were then inserted at varying distances downstream from the disposal unit. In addition, test wells were installed upgradient from the disposal unit. The test wells were generally placed in groups of three at each location, the first well being installed in the upper position of the slug, the second well in the center of the slug and the third well at the bottom of or below the slug. When finally positioned, the test wells were pumped until clear and capped to grade.
7. A well point was inserted into the cesspool and/or septic tank at a point halfway into the liquid content in order to retrieve sewage samples.
8. A water meter was connected to the discharge side of the domestic well serving the site. The homeowner was provided with the test packages of the ABS products. Instruction was given on the use of the test product and the need to record the amount of detergent used.
9. A tracer substance was placed in the disposal unit on Sites 1 through 4 in order to obtain ground water velocity data. In the course of the project, hexavalent chromium, chloride, sodium chloride and tritium were employed as tracers. The results obtained and the success of these tracers are reported upon under each specific site.
10. The wells were sampled on alternate weeks by teams of 2 to 4 sanitarians from the Nassau and Suffolk Health Departments. C.W. Lauman and Company provided for maintenance of the wells and other equipment employed on the site. Approximately 2 gallons of water were pumped from each well before collection of sample in order to clear the well of any water which might be

standing in the casing and point. The pumping to clear was curtailed in order to maintain as nearly as possible the status of the well as a collecting device and not a discharging well. The sample was collected in a 5-gallon plastic container fitted with a spigot on the bottom. The 5-gallon sample was split into seven various size portions, which were delivered to each of the participating laboratories. The laboratory analyses were performed through a cooperative effort by the Nassau County Health Department, Division of Laboratories and Research, Suffolk County Water Authority, New York State Health Department Division of Laboratories and Research and laboratory facilities of the members of the Soap and Detergent Association. The samples which were analyzed in the local laboratories were delivered on the day of collection. The samples for the nitrogen cycle and chlorides were mailed to the New York State Health Department Laboratory in Albany.

11. Special procedures were followed in obtaining bacteriological samples in order to avoid introduction of bacterial contamination. Prior to installation on the test well, the hand pump was placed in a 30-gallon plastic pail containing a solution of approximately 2,000 mg/l of free chlorine. The chlorine solution was flushed through and permitted to stand for several minutes in the pump. The chlorine solution was then removed and the pump placed on the test well. The test well was cleared until an orthotolidine test indicated the water to be free of chlorine. In addition to disinfection of the pump, the test wells at each site were sampled in a specific sequence, beginning with wells which were expected to be free of coliforms and followed by wells with progressively higher expected bacterial densities.

PART 4 - SUMMARY AND SITE COMPARISONS

Background Well Data

The ground water quality upstream from the disposal systems at the six sites reflects the natural water in the glacial aquifer on the southern tier of Long Island on which is superimposed, to various degrees, the influence of domestic sewage discharges. A summary of the values of typical constituents is shown on Table 4-1.

The coliform values in general varied from an average MPN of 0 to 41 per 100 ml, thereby demonstrating the filtering action of sandy soil both in unsaturated and saturated zones, but to an insufficient degree to prevent local ground water contamination by sewage disposal systems. The high value of 496 per 100 ml at Site 6 is not consistent with other sites or the levels of other sewage constituents from the same well and may be due to some unique local influence.

Values of MBAS in the background varied from averages of 0 to 0.11 mg/l. Levels generally varied directly with that of other soluble sewage products such as phosphates, nitrates, sulfates and chlorides. Exceptions were, higher chlorides and specific conductance values at Site 5 and relatively higher sulfates at Sites 2 and 5 than at the other sites. Distinct waste plumes having origin at some distant upgradient polluting source were observed on Sites 1, 2 and 6. Background observation wells on Site 1 were more than 500 feet downstream from any other sewage systems.

Disposal System Concentrations

The concentration of sewage constituents in the septic tank or cesspool at each site was fairly consistent and primarily reflect differences in family size and habits. Values for typical constituents are shown in Table 4-2.

Detergent levels tended to be uniform from site to site for each test product but with several exceptions. ABS values were consistent at 40 mg/l for Sites

Table 4-1

BACKGROUND WELL CONCENTRATIONS

SITE

CONSTITUENT	1	2	3	4	5	6
MBAS as ABS	0.02	0.02	0.04	0.11	0.02	0
Chlorides	8.0	13.0	5.30	19.3	24.1	6.1
Total PO ₄	0.10	0.04	0.06	1.10	0.03	0.1
Spec. Cond.	85	150	60	132	223	59
Alkalinity as CaCO ₃	16.0	23.0	25.0	15	14	16.0
Sulfates	19	52	10	31	72	25
Colliform Log Avg MPN/100 ml	2.2	45	20	19	41	496
Ammonia Nitrogen	0.02	0.35	0.03	0.07	0.05	0.08
Nitrate Nitrogen	5.1	4.0	1.4	8.2	5.3	0.3
COD	-	7.3	15.0	10.0	-	-

TABLE 4-2

DISPOSAL SYSTEM CONCENTRATIONS

Note: Products are listed in the order in which tested

Site #1

	ABS	LAS ₁	Soap	LAS ₂	AS
MBAS as ABS	40.1	53.4	3.5	21.3	14.6
Ammonia	79.5	68.8	64.5	73.7	64.4
Chlorides	69.7	72.6	66.5	63.0	56.5
Total Phosphates	111.0	103.0	55.5	88.5	76.0
Spec. Cond.	-	655.0	680.0	835.0	845.0
Alkalinity	470.0	375.0	359.0	381.0	426.0
Sulfates	36.0	126.1	40.4	29.0	7.8
Coliform(Log Aver. x 10 ⁶)	114	133	5.24	9.02	22.4
Nitrite	0.02	0.02	0.01	0.02	0.01
Nitrate	0.12	0.10	0.12	0.10	0.14
COD	309.0	281.0	153.0	-	-

Site #2

	ABS	LAS ₁	AS	Soap	LAS ₂	Sucrose Ester
MBAS as ABS	41.1	24.3	13.4	2.3	18.4	5.3
Ammonia	51.6	56.5	52.5	63.0	58.9	60.0
Chlorides	60.0	53.7	47.0	53.8	50.6	55.5
Total Phosphates	74.0	71.0	81.5	47.5	86.0	122.0
Spec. Cond.	558.0	640.0	675.0	760.0	-	-
Alkalinity	293.0	333.0	295.0	380.0	385.0	345.0
Sulfates	177.0	65.2	34.0	8.2	10.9	29.0
Coliform(Log Aver. x 10 ⁶)	1.23	1.74	3.34	10.2	1.39	1.67
Nitrite	0.01	0.01	0.01	0.02	0.02	0.02
Nitrate	0.10	0.10	0.13	0.10	0.10	0.07
COD	233.0	142.0	-	-	184.0	236.0

Site #3

	ABS	LAS
MBAS as ABS	40.0	29.2
Ammonia	90.3	83.5
Chlorides	64.5	57.0
Total Phosphates	88.3	66.5
Spec. Cond.	850.0	815.0
Alkalinity	423.0	450.0
Sulfates	34.2	10.8
Coliform(Log Aver. x 10 ⁶)	8.59	16.5
Nitrite	0.02	0.02
Nitrate	0.10	0.19
COD	191.0	-

TABLE 4-2
(continued)

DISPOSAL SYSTEM CONCENTRATIONS

Site #4

	Soap	LAS
MBAS as AS	1.4	28.8
Ammonia	115.0	94.0
Chlorides	73.0	61.5
Total Phosphates	56.9	81.5
Spec. Cond.	914.0	953.0
Alkalinity	549.3	440.0
Sulfates	11.8	51.2
Coliform(Log Aver. x 10 ⁶)	6.31	3.51
Nitrite	0.01	0.02
Nitrate	0.10	0.95
COD	207.0	-

Site #5 (Septic Tank)

	LAS	AS	Soap	ABS
MBAS as ABS	9.8	6.2	1.01	11.7
Ammonia	61.2	79.0	81.3	61.5
Chlorides	56.2	51.8	61.3	52.0
Total Phosphates	57.5	64.2	49.3	62.6
Spec. Cond.	646.	840.	795.	727.
Alkalinity	306.	422.	481.	437.6
Sulfates	16.4	10.2	1.8	3.1
Coliform(Log Aver. x 10 ⁶)	2.23	5.89	1.68	1.68
Nitrite	0.	0.02	0.01	0.01
Nitrate	0.	0.72	0.03	0.4
COD	-	-	-	-

Site #6 (Septic Tank)

	LAS	AS	Soap	ABS
MBAS as ABS	26.0	16.2	3.0	12.5
Ammonia	102.	95.5	94.0	116.0
Chlorides	106.	107.0	97.1	96.
Total Phosphates	103.	100.	53.7	70.
Spec. Cond.	1050.	1240.	580.	1180.
Alkalinity	491.	546.	596.0	325.
Sulfates	100.	46.2	26.6	21.
Coliform (Log Aver. x 10 ⁶)	1.66	8.78	1.84	4.3
Nitrite	0.02	0.02	0	0
Nitrate	0	0.08	0.05	0
COD	-	-	-	-

1, 2 and 3 and at approximately 12 mg/l for the two tile field sites. LAS levels were generally consistent between 20 - 30 mg/l except for an average value of 53 at Site 1, and 10 mg/l at Site 5. Synthetic detergent levels tended to be appreciably smaller in the period following soap tests apparently due to increase in adsorption capability within the system.

Infrared analysis of sludge material collected from the disposal system of Site 3 during LAS usage indicated an average of 25 percent branched material (ABS) in the sludge. In the liquid phase of the cesspool, branched material reduced to 0 percent during LAS usage, but aeration of the cesspool apparently re-suspended sludge material and thereby increased the branched material in the liquid phase to 5 percent.

Chlorides remained at constant levels at each site throughout the study, generally between 50 to 70 mg/l except at Site 6 where average values fluctuated between 96 and 107.

Ammonia levels also reflected a site characteristic regardless of test product. Average values ranged between 52 and 115 mg/l as N although the range of averages at each site varied only between 6 and 20. Sites 4 and 6 demonstrated higher values, both averaging between 94 and 115 mg/l. Nitrite values were negligible with highest average at 0.02 mg/l as nitrogen. Nitrate values were uniformly low at all sites, averaging below 0.20 mg/l as N except for average values of 0.95 mg/l at Site 4 during LAS tests and 0.72 at Site 5 during AS use.

Alkalinity varied between 293 and 596 mg/l as CaCO_3 at all sites. The range at each site was between 27 and 250 with the greater fluctuations at Sites 5 and 6.

Specific conductance average values were between 518 and 1240 micromhos/cm for all sites although the range of averages at each site was generally smaller varying from only 35 at Sites 3 and 4 to 240 at Site 6.

Phosphate values averaged between 58 and 122 mg/l for all test products except

soap. During soap use the averages were between 48 and 57 mg/l at all sites. No pattern of phosphate levels was evident for the other test products or type of system.

Sulfate levels varied markedly from site to site and for different test products at each site. Overall, the average values extended from 2 to 177 mg/l. Average values over 100 mg/l occurred on Sites 1, 2 and 6. Sites 3, 4 and 5 exhibited the lowest levels and range with average values all below 51 mg/l. There did not appear to be a relationship between average sulfate levels in the disposal system and the sulfonate group present in the various washing compounds used.

The coliform concentrations in the disposal systems averaged between a log average of 1.2×10^6 and 22.4×10^6 except for values of 114×10^6 and 133×10^6 at Site 1 during ABS and LAS tests. Eighteen of 23 average values were less than 10×10^6 including all values at Sites 4, 5 and 6.

COD average values were between 153 and 309 mg/l for some test products at Sites 1 to 4. COD analyses were not conducted for all phases at all sites.

Detergent and Water Use

Detergent product and water use at each site and computed MBAS input on mg/l basis is shown in Table 4-3. The calculated MBAS varied from zero during use of soap and Sucrose Ester to 64 mg/l at Site 1 during ABS tests. The two percolation field sites generally exhibited lower and less consistent values than the cesspool sites. For Sites 1 through 4, the MBAS during ABS use varied from 44.5 to 64 mg/l and during LAS tests for eight product cycles from 20.7 to 36.3 mg/l. During AS use, the MBAS input varied from 23.6 to 30.9 mg/l on these sites.

Water use varied from averages of 110 to 447 gallons each day at all sites exclusive of lawn sprinkling and other outside usage. Generally, water consumption was affected primarily by season with summer use twice the winter use.

Table 4-3

Product and Water Use

Product	Time of Test (weeks)	Boxes*	<u>Detergent Used</u>		<u>Water Use</u> (gal/wk.)	<u>MBAS (mg/l)</u>	
			Total Wt. (lbs.)	Weight/Wk. (lbs.)		Computed	Observed
<u>Site #1</u>	Oct. 15, 1962						
ABS (MBAS)	Feb. 25, 1963	26	32½	2.38	1100	64.0	40.1
LAS "	Feb. 25, 1963						
	June 12, 1963	29	36¼	1.82	1575	36.3	53.4
Soap "	June 12, 1963						
	March 1, 1964	52	65	1.75	1390	0	3.5
LAS "	March 1, 1964						
	Sept. 2, 1964	50	62½	2.40	2300	32.8	21.3
AS "	Sept. 2, 1964						
	Nov. 30, 1964	14	17½	1.34	1230	23.6	14.6
<u>Site #2</u>							
ABS "	Feb. 12, 1963						
	June 1, 1963	48	60	3.75	1930	57.5	41.1
LAS "	June 1, 1963						
	April 22, 1964	108	135	2.92	3130	29.3	24.3
AS "	April 22, 1964						
	Dec. 7, 1964	96	120	3.64	2545	30.9	13.4
Soap "	Dec. 7, 1964						
	Aug. 24, 1965	98	122½	3.21	2680	0	2.3

Table 4-3 (continued)

Product and Water Use

Product	Time of Test (weeks)	Boxes*	Detergent Used		Water Use (gal/wk.)	MBAS (mg/l)	
			Total Wt. (lbs.)	Weight/Wk. (lbs.)		Computed	Observed
LAS (MBAS)	Aug. 24, 1965 Nov. 22, 1965	33	37	2.85	2745	32.6	18.4
Sucrose Ester"	Nov. 22, 1965 March 14, 1966	51	63½	3.92	1665	0	5.3
<u>Site #3</u>							
ABS "	Sept. 16, 1963 Jan. 4, 1965	98	122½	1.91	1275	44.5	40.0
LAS "	Jan. 4, 1965 Jan. 24, 1966	84	105	1.91	1675	35.8	29.2
<u>Site #4</u>							
Soap "	Dec. 4, 1963 March 9, 1964	16	20	1.43	1050	0	1.4
LAS "	March 9, 1964 June 28, 1965	76	95	1.39	1160	36.2	28.8
<u>Site #5</u>							
LAS "	April 15, 1964 Sept. 3, 1964	36	45	1.3	2205**	29.7	9.8

Table 4-3 (continued)

Product and Water Use

Product	Time of Test (weeks)	Boxes *	Detergent Used		Water Use (gal/wk.)	MBAS (mg/l)	
			Total Wt. (lbs.)	Weight/Wk. (lbs.)		Computed	Observed
AS (MBAS)	Sept. 3, 1964 Jan. 19, 1965	20	25	1.5	1106	23.7	6.2
Soap "	Jan 19, 1965 April 13, 1965	6	8	.67	1624	0	1.0
ABS "	April 13, 1965 Sept. 20, 1965	20	25	.96	2170	21.0	11.7
<u>Site #6</u>							
LAS "	April 9, 1964 Sept. 3, 1964	30	37.5	1.04	1568	20.7	26.0
AS "	Sept. 3, 1964 Jan. 19, 1965	13	16.25	.75	1057	15.3	16.2
Soap "	Jan. 19, 1965 April 13, 1965	6	8	.67	924	0	3.0
ABS "	April 13, 1965 April 27, 1965	2.0	2.5	1.25	775	48.5	12.5

* Box content was 20 oz.

**Average non-summer water use of 1365 gal/wk. used for all MBAS concentration calculations for Site 5. Values shown include outside hose bib.

Typical winter usage was 150 to 160 gal/day, while summer use was 300 - 325 gal/day.

The syndet input was generally appreciably higher than indicated by MBAS analysis of samples from the disposal system. The difference was apparently caused by the normal erratic usage of detergents in normal domestic operations and the non-uniform dispersal of the detergent products in the septic tank or cesspools. Synthetic detergents adsorbed on settleable solids would appear in the sludge or scum rather than in the supernatant which was generally sampled. This characteristic would be more pronounced in a septic tank, which is specifically designed for suspended solids removal as opposed to a cesspool. The data on Site 5 revealed actual MBAS in the range of 1/4 to 1/2 of the actual consumed quantities as opposed to a range of 2/3 to 5/6 on Sites 1, 3 and 4 and 43 to 83 percent on Site 2. Site 6 did not demonstrate this removal efficiency except during ABS tests.

Product quantity decreased up to 20 percent and water consumption increased by as much as 50 percent during use of LAS as compared with ABS test products.

Effects of Different Sub-Soils

Soil characteristics on Sites 1, 2 and 3 were relatively similar, of predominantly medium to coarse sands and gravel with a soil porosity range of 29 to 38 percent. Subsoil on Site 4 was markedly different consisting of silty sand with traces of gravel. Site 5 subsoil was medium to fine sand while Site 6 soil was sandy clay, grit and stones.

Site 4 exhibited generally greater capacity for reduction of several constituents compared to Sites 1 to 3, including MBAS (during LAS tests), ammonia, sulfates, phosphates, alkalinity and specific conductance. Site 6 removals were generally higher than Site 5 for MBAS (during use of all test products), sulfates and phosphates. Site 5 was higher than Site 6, however, in reductions of alkalinity, specific conductance and ammonia. Other variables than soil differences

were present, however, to account for higher general efficiencies of Sites 4 and 6, including type and age of system, length of unsaturated flow path and availability of dissolved oxygen in the ground water.

Analyses were made by the U.S.G.S. of ABS adsorption capacities of subsoils at Site 1 with reported values of 50 - 70 micrograms of ABS per gram of sand. These capacities are not considered to be large on a unit of soil basis but can nevertheless play a significant role in sorption of synthetic detergents due to the long flow path involved in the unsaturated and saturated zones.

Ground Water Movement

Several tracer materials were studied to measure ground water flow rates including sodium fluoride, chlorides, hexavalent chromium, and radioactive substances. Successful determinations were made at Sites 1, 2, and 3. Rates of ground water movement at Site 4 could not be clearly established. No attempt was made at Sites 5 and 6 to measure rate of travel.

Sodium Fluoride

Sodium fluoride was successfully traced on Site 1 from cesspool to a test well 10 feet distant and subsequently to another well 21 feet distant from the source. Three pounds of tracer material dissolved in hot water was added to the cesspool. Rates of travel of 0.33 ft/day and 0.28 ft/day were established in time periods of 32 and 75 days respectively. Sodium fluoride was also successfully used on Site 2 in the same manner. The tracer was retrieved in three wells 10, 20, and 40 feet downgradient to establish a velocity of 0.66 ft/day.

Sodium Chloride

Sodium chloride was also effectively used to confirm rates of ground water movement at Site 1, using 4 and 6 inch diameter polyvinyl-chloride pipe wells with 1/16 inch diameter holes drilled on 1-1/2 inch centers in the lower 12 inches of pipe to permit movement of ground water. Wells were sampled with a bomb sampler lowered into the well. Rate of travel of 0.33 ft/day was confirmed.

Test distance was 5 feet. This procedure was also used on Site 3 to measure movement of 0.6 ft/day.

Hexavalent Chromium

Use of hexavalent chromium as tracer was not effective in determining rates of ground water movement due to apparent sorption or chemical reduction of the tracer material on subsoils and on materials within the disposal system itself.

Radioactive Tracer

Ground water travel rates were studied at Site 3 by measuring movement through unsaturated and saturated soil of radioactive material added to the cesspool in a single dose (Phase I). Determination was based on peak tritium activities at each sampling point which provided incremental and overall travel rates as shown in the following tabulation:

Unsaturated Zone (20 feet vertical travel) -

Cesspool to Top Sampler	*0.75 ft/day
Top to Middle Sampler	1.33
Middle Sampler to Well #6	1.60
Cesspool to Middle Sampler	1.10
Cesspool to Well #6	<u>1.15</u>
Average Rate of Travel	1.29 ft/day

Saturated Zone -

Well #6 to #10 (10 ft. of travel)	0.91 ft/day
Well #10 to #13 (10 ft. of travel)	*5.0
Well #6 to #13 (20 ft. of travel)	<u>1.54</u>
Average Rate of Travel	1.23 ft/day

*Not included in Averages

Travel rates in the saturated zone determined on basis of tritium study are generally twice that established by use of chemical tracers. Rates based

upon the first indication of tritium activity, resulting from the continuous dosage in the Phase II study, could not be accurately determined. This was due to the inability to distinguish the initial tritium arrival date at some of the downstream sampling locations.

Constituent Reduction Comparisons

Chlorides

Chloride reductions through the unsaturated and the saturated soil was considered to be a measure of dilution accomplished by mixing with ground waters of lower chloride content.

Chloride reductions from the disposal systems at each site to initial downstream well group are summarized in the following table:

Percent Reduction of Chlorides Through Disposal System

Sites	ABS	LAS ₁	LAS ₂	AS	Soap	Sucrose Ester
1	5	3	2	1	5	-
2	(12)	(6)	(5)	(6)	(11)	(5)
3	18	24	-	-	-	-
4	-	20	-	-	63	-
5	2	13	-	22	19	-
6	18	25	-	22	14	-

Note: Values in parenthesis represent increase in values.

A more specific delineation of reduction through unsaturated soils was available from Site 3 data where sampling devices were available within the unsaturated soil. The removals are shown in the following tabulation:

Average Chloride Reductions
In Unsaturated Soil of Site 3 (mg/l/ft.)

	<u>Cesspool to</u> <u>Top Samplers</u>	<u>Top to Middle</u> <u>Samplers</u>	<u>Middle to Bottom</u> <u>Samplers</u>
	(1.5 ft. Travel Distance)	(4.0 ft. Travel Distance)	(4.0 ft. Travel Distance)
ABS	(1.33)	1.82	0.75
LAS	(1.40)	0.65	0.70

Note: Values in parenthesis represent increase in values.

The removals within the saturated zones are shown on the following tabulation:

Site	<u>Velocity</u>	<u>Reduction of Chlorides</u>		<u>Percent per Linear Foot</u>	
		<u>mg/l per Linear Foot</u> <u>Range</u>	<u>Average</u>	<u>Range</u>	<u>Average</u>
1	0.33 ft/day	0.39 - 0.60	0.51	0.70 - 0.88	0.81
2	0.07 ft/day	0.15 - 0.33	0.24	0.31 - 0.61	0.43
3	0.60 ft/day	0.19 - 0.29	0.24	0.35 - 0.67	0.51

The apparent higher rate of reduction through the unsaturated soil appears to be due to the natural influence of interstitial water and the lack of ability of the gravity and tensionmeter sampling devices to selectively sample the cesspool effluent. The same general problems are present in sampling the saturated soil zone except that the waste slug can usually be more accurately located during initial probes and the sampling techniques are more reliable.

The use of radioactive tracers at Site 3 provided an opportunity to compare reduction rates. The dilutional effects as measured by changes in peak tritium levels indicated a rate of reduction or dilution significantly greater than observed for chlorides. The rates of reduction are tabulated as follows:

Rates of Reduction (Dilution) in Percent per Linear Foot of Travel

	<u>Unsaturated Zone</u>	<u>Saturated Zone</u>
Tritium (Las test) Phase I	4.0	2.32
Phase II	0.73	1.43
Chlorides (ABS test)	0.9	0.35
Chlorides (LAS test)	1.17	0.67

The discrepancy in results is probably due to the short duration of the radiotag study, limited samples, and limitations in analytical techniques. Chloride levels are, therefore, considered to be a more reliable indicator of dilution.

MBAS Reported as ABS

The reduction in MBAS through the disposal systems at all sites varied considerably for different sites and test products. Average disposal system concentrations and percent removals to initial test wells are summarized in Table 4-4.

The wide variation is caused by several factors intrinsic to the system and to difficulties in accurately sampling the representative sewage in the system and downgradient waste plume. The system concentration which is measured by a given sample is influenced by many factors including the following:

1. Frequency and quantity of detergent usage.
2. Quantity of rinse water used in washing operations.
3. Other water usage concurrent with washing operations.
4. Change in detergent product use.
5. Cesspool liquid level fluctuations.
6. Adsorption capacity of system contents.
7. Seasonal turnovers of system contents.
8. Age of system.
9. Sampling procedure.

Table 4-4

MBAS Concentration in Disposal System
and Percent Removal Achieved

Site	1	2	3	4	5	6
Test Product	A* - B*	A - B	A - B	A - B	A - B	A - B
ABS	40 - 14	41 - 2	40 - 59	- -	12 - 60	13 - 78
LAS ₁	53 - 47	24 - 8	29 - 57	29 - 99	10 - 18	25 - 56
LAS ₂	21 - 72	18 - 31	- -	- -	- -	- -
AS	15 - 38	13 - 22	- -	- -	6 - 9	16 - 53
Soap	4 - (176)	2 - (288)	- -	1 - 7	1 - (167)	3 - 37
Sucrose Ester	- -	5 - (101)	- -	- -	- -	- -

* A- Disposal System Concentrations (mg/l).

B- Percent Removal to first test well group.

Note: Values in parenthesis represent increases.

The concentration in the ground water immediately downgradient from the system is affected by several other factors as follows:

1. Fluctuation in concentration of syndets in system effluent.
2. Change in basic functioning of system affecting point of effluent discharge or discharge path.
3. History of previous detergent types used in household.
4. Selective adsorption capacity of soil for successive test detergents and degree of saturation already achieved.
5. Fluctuations in static ground water level.
6. Changes and fluctuations in direction and rate of ground water movement.

The influence of many of the factors which determine syndet concentrations and removals are mitigated by long term sampling. The average values are considered representative of typical households and ground water conditions.

Although MBAS concentrations in the disposal system and immediately adjacent groundwaters varied considerably, a relatively smaller difference in MBAS levels were observed at the final downstream wells at Sites 1 through 4 as tabulated below:

<u>Site</u>	<u>Travel Dist.(ft.)</u>	<u>Travel Rate (ft/day)</u>	<u>MBAS in Final Wells (mg/l)</u>
1	80	0.33	0.6 - 2.5
2	65	0.67	10.4 - 14.3
3	45	0.60	6.3 - 11.1
4	31	-	0.4 - 0.6

MBAS reduction rates in the downstream saturated zone varied considerably with use of different surfactants. There was no correlation evident of reduction rate for a particular surfactant on the four test sites, or for different detergents on the same site. Comparison of reduction rates in the saturated zone with chloride reductions demonstrates the selective removal of syndets by

sorption. The data for Sites 1, 2, and 3 tabulated below shows MBAS removals exceeding chloride removal in a range from 1 to 70 per cent.

MBAS and Chloride Reduction in Saturated Zone

Site	1	2	3
Constituent	Overall Removal/Removal per Linear Foot (mg/l)		
ABS	98/1.3	47/1.2	32/0.8
Chlorides	65/0.9	19/0.3	14/0.4
LAS ₁	97/1.3	24/0.6	50/1.3
Chlorides	64/0.9	18/0.3	27/0.7
LAS ₂	59/0.8	40/1.0	-
Chlorides	58/0.7	37/0.6	-
AS	123/1.7	25/0.6	-
Chlorides	53/0.7	20/0.3	-
Soap	82/1.1	78/0.2	-
Chlorides	62/0.8	32/0.5	-
Sucrose Ester	-	48/1.2	-
Chlorides	-	31/0.5	-
Travel Distance	75 ft.	60 ft.	40 ft.

Note: Removals shown represent first to last wells downgradient from disposal system.

Although large bacterial populations existed in the initial flow path on all sites, a relationship between MBAS levels and bacterial densities was not revealed.

Infra-red analyses during initial use of LAS on Site 2 indicated that 56 - 90 percent of the material retrieved from test wells was branched chain (ABS) surfactant and on Site 3, 83 - 100 percent, despite an extensive period of household use of straighter chain (LAS) surfactant.

The continued appearance of ABS is apparently due to desorption of previously deposited molecules of ABS and replacement by LAS in newly arriving wastes.

General usage of sucrose ester or soap materials as household washing

compounds would result in an immediate decrease in the quantity of MBAS being leached by disposal systems and cause progressive desorption of branched chain ABS from the soil.

The number of infra-red analyses was insufficient to establish a clear relationship between ABS, LAS and other materials studied throughout all phases of the study.

Degradation of radio-tagged surfactant was studied at Site 3 by use of LAS³⁵ and tritium added to the cesspool. Phase I involved addition of a single dose while Phase II entailed continuous dosing.

Cesspool samples indicated that no degradation of the tagged LAS³⁵ occurred in the liquid portion of the disposal system.

There was no apparent preferential holdup of tritium, total or undegraded sulfur in the disposal system or downstream sampling locations.

Reasonably consistent ratios of total to undegraded sulfur³⁵ at each sampling point in the unsaturated soils indicated what appears to be degradation rather than some other process.

Degradation of the LAS³⁵ molecule appeared to occur during Phase I at the sewage-soil interface and also at the interface of the unsaturated-saturated soil zone. Degradation was observed throughout the entire unsaturated zone during Phase II study. Generally, degradation of the LAS³⁵ molecule occurred prior to the first downstream sampling point. Percent degradation is tabulated below:

	<u>Percent Degradation</u>		<u>Average Percent MBAS Reduction</u>	
	<u>Phase I</u>	<u>Phase II</u>	<u>ABS</u>	<u>LAS</u>
<u>Cesspool</u>	0	0	0	0
<u>Unsaturated Zone</u>				
Top	48.8	39.4	52.3	54.5
Middle	43.6	46.0	50.0	40.8
Bottom	-	52.5	72.5	37.0

	<u>Percent Degradation</u>		<u>Average Percent MBAS Reduction</u>	
	<u>Phase I</u>	<u>Phase II</u>	<u>ABS</u>	<u>LAS</u>
<u>Saturated Zone</u>				
Well 6	79.0	67.2	59.0	57.0
Well 10	77.0	53.6	63.5	54.6
Well 13	77.4	36.4	65.5	42.5

Degradation of the tagged LAS³⁵ was not observed in movement of the slug through the downstream saturated soil zone.

Initial travel in the unsaturated soil zone, cesspool to top collectors (18 inches of travel) accounted for the greatest amount of degradation of LAS³⁵. Similarly significant reductions in average MBAS levels also occurred in this initial travel distance of 18 inches.

Significant overall reductions of tritium and sulfur activities resulted during both phases of the study. Generally most of the reduction activity occurred in the first 18 inches of travel in the unsaturated zone except for tritium during the Phase II study as shown in the following data summary:

Percent Reductions of Cesspool Peak Activities

<u>Overall Reductions -</u>	<u>Tritium</u>	<u>Total Sulfur</u>	<u>Undegraded Sulfur</u>
Phase I	60.6 - 89.3	89.8 - 97.1	96.4 - 99.3
Phase II	2.9 - 38.5	82.0 - 90.3	91.5 - 95.8
Initial 18" travel -			
Phase I	66.0	94.0	97.3
Phase II	5.45	83.8	91.5

Possible short-circuiting of the bottom collectors in the unsaturated zone and Well 6 is substantiated by the increase in activities between Well 6 and 10 during both study periods and also by the malfunctioning of the bottom collectors.

Sulfur³⁵ degradation in the cesspool sludge of 51-65 percent was observed during a short testing interval at the end of the Phase II study.

Soil core samples collected after continuous dosing of the cesspool was discontinued, indicated between 19.7 and 58.1 percent degradation of sulfur³⁵.

There was absorption-desorption of tagged LAS material on the sludge and soils as demonstrated by the continued release of small amounts of radioactive materials seven months after completion of the Phase II study.

Dissolved Oxygen (DO)

Test wells located within the waste plume of the cesspool sites were virtually devoid of dissolved oxygen; those wells influenced by the tile field effluent on Sites 5 and 6 were significantly lower in oxygen than unpolluted water peripheral to the waste slug.

Test wells screened above and below the waste plume revealed strikingly higher DO values.

The dissolved oxygen in all wells at Site 4 revealed relatively higher values than from comparable wells at other sites, indicating either elusiveness of the waste plume or lack of oxygenation potential of the sewage slug from that site.

No DO data was obtained for Site 3.

A summary of DO levels at all test sites is shown in Table 4-5.

The depletion of DO at various points in the ground water is generally indicative of the biological and/or chemical oxygen demand of the waste products discharged to the ground water.

pH

The pH in the ground water downgradient from the disposal system at the test site remained fairly consistent for each site with averages ranging from 4.5 to 7.1. Test wells evidencing constituents of pollution were slightly higher in pH than unpolluted wells.

Table 4-5

Average Dissolved Oxygen Concentrations (mg/l)

<u>Site #1</u>		<u>Site #2</u>		<u>Site #4</u>		<u>Site #5</u>		<u>Site #6</u>	
Well No.	Dissolved Oxygen	Well No.	Dissolved Oxygen	Well No.	Dissolved Oxygen	Well No.	Dissolved Oxygen	Well No.	Dissolved Oxygen
1N	4.0 mg/l	1	1.2	1	4.0	1N	5.7	1N	2.6
2N	0.5	2	0.3	2	4.2			2N	4.3
3N	0.4	3	3.1						
				4	6.4	2	1.6	2	0.7
1	4.6	5	0.0	5	6.4	3	0.04	4	0.1
2	1.5	6	0.7	6	4.8	4	1.6	5	0.2
3	0.26	7	0.0						
4	1.9	8	0.0	7	4.8	6	0.1	6	0.1
				8	5.6	7	0.001	8	0.01
24	1.1	10	0.0	9	4.1			9	0.02
24A	0.0	11	0.0			9	1.6		
		12	0.5	10	3.9	10	0.5	10	1.3
25	3.35			11	4.8			11	0.0
26	0.17	14	0.2	12	4.6			12	0.7
27	3.26	15	0.0					13	0.9
		16	0.0	13	5.4				
32	2.52			14	4.5			14	2.8
33	0.0	17	0.1	15	3.3				
34	4.86	18	0.0						
		19	0.4						
17	0.98								
18	0.0								
19	0.90								
20	2.30								
21	2.70								

Ammonia

Nitrogen in sewage was demonstrated to be partially converted from the organic to the nitrate form in passage progressively through the disposal system, the unsaturated soil, and those portions of the saturated soil zone which were observed. The conversion rate varied from site to site and was related generally to the length of path through the unsaturated soil zone. The total nitrogen concentration at successive points along the flow path was found to diminish and is attributable to a combination of dilution, adsorption and ion exchange.

The initial concentration of free ammonia in the disposal system is increased at the sewage-soil interface through conversion of organic nitrogen by bio-chemical oxidation while in contact with the zooglear film at the interface. This phenomenon was demonstrated at Site 3 where free ammonia levels increased 61 percent (90 to 145 mg/l) during ABS use in passage between the cesspool and top sampler located 18 inches below the bottom of the cesspool.

Subsequent movement into the unsaturated soil generally caused free ammonia to decrease significantly. The decrease appears to take place immediately upon entry of sewage into the unsaturated soil zone. Free ammonia levels at Site 3 were reduced 77.3 percent (from 145 to 33 mg/l) between the top and middle samplers separated by a vertical distance of 4 feet. The ammonia remained relatively unchanged in the remaining 11 feet of travel in unsaturated soil.

Overall net reductions in free ammonia in passage through unsaturated soils were greatest at Site 3 involving a vertical travel distance of 15 feet through coarse sand and at Site 4 with a distance of 9 feet through fine sand. Large reductions were also observed at the two tile field sites averaging between 50 and 80 percent except for 25 percent reduction at Site 6 during AS and soap use. On the other hand, free ammonia levels actually increased at Site 2 where the

cesspool was partially submerged in ground water and the soil was coarse sand. Reduction in ammonia levels are caused by oxidation to nitrate, by adsorption and by ion exchange. Some of the reduction is apparent only and due to dilution and inability to accurately sample the sewage plume. The tendency for greater reductions through finer soils is indicative of greater adsorption and/or ion exchange capability. Additional support for this explanation is provided by the frequently observed lack of corresponding increases in other forms of nitrogen. Ammonia reductions are summarized in Table 4-6 and 4-7.

The ammonia levels in the saturated soils peaked at one of the intermediate test well groups. For all surfactants on Site 1, and during the use of the initial three surfactants (ABS, LAS, AS) on Site 2, ammonia reductions were accounted for entirely by dilution. Predominantly greater reductions in free ammonia resulted during use of the final three surfactants (Soap, LAS, Sucrose Ester) on Site 2 and for all surfactants used on Sites 3 and 4. Since there was no corresponding increase in other nitrogen compounds, the free ammonia reduction through this portion of the flow path was probably caused by adsorption and ion exchange.

Nitrites

Nitrite levels were minimal at all phases of all sites for all test products. The nitrite is an unstable transitional stage in the conversion of free ammonia to the nitrate form.

Nitrite values appear to have peaked within the unsaturated zone corresponding to the peak in nitrate concentrations. At Site 3 the nitrate concentration was demonstrated to peak at the bottom samplers in the unsaturated zone.

Nitrates

Nitrate levels generally increased in passage through unsaturated soil from virtually zero values in the raw sewage. At Site 3, peak values were observed

Table 4-6

Percent Reduction of Free Ammonia Through Unsaturated Soil

Site	Dist*	Soil	Test Products					Sucrose Ester
			ABS	LAS ₁	LAS ₂	AS	Soap	
1	0	Fine to coarse sand	40	4	35	30	50	-
2	-2	Coarse sand	(15)**	(2)	(2)	(20)	(15)	(2)
3	15	Fine sand	59	69	-	-	-	-
4	9	Fine, silty, sand	-	99	-	-	96	-
5	5	Medium to fine sand	40	40	-	80	80	-
6	2	Fine sand	75	50	-	25	25	-

* Vertical distance from bottom of cesspool (tile field) to static ground water level.

**Numbers in parenthesis represent increase.

Table 4-7

Ammonia Reductions Through Unsaturated & Saturated Zones

Site	Travel Dist. in Sat. Zone (ft.)	Bkgd. Conc. (mg/l as N)	Range of Average Conc. In System (mg/l as N)	Percent Remaining *					
				ABS	LAS ₁	LAS ₂	AS	Soap	Sucrose Ester
				<u>A - B</u>	<u>A - B</u>	<u>A - B</u>	<u>A - B</u>	<u>A - B</u>	<u>A - B</u>
1	80	0.02	64.4 - 79.5	99 - 32	94 - 32	74 - 47	94 - Unk	85 - 15	-
2	65	0.35	51.6 - 63.0	120 - 100	110 - 91	107 - 19	117 - 93	108 - 56	99 - 21
3	45	0.20	83.5 - 90.3	32 - 21	31 - 14	-	-	-	-
4	31	0.15	94.0 - 115.0	-	1 - 1	-	-	4 - 1	-
5	-	0.72	61.2 - 81.3	60 - Unk	56 - Unk	-	33 - Unk	33 - Unk	-
6	-	5.5	94.0 - 116.0	59 - Unk	54 - Unk	-	77 - Unk	79 - Unk	-

* A - Percent Remaining at First Well Group

B - Percent Remaining at Last Well Group

at the bottom sampling devices in the unsaturated soils after a vertical travel distance of 9.5 feet.

The increase in nitrate nitrogen in unsaturated soil was consistent with reduction in free ammonia in many instances. Exceptions were noted particularly at Site 2 where free ammonia levels increased in passage through unsaturated soils with little or no production of nitrates and at Sites 4 and 6 where significant reduction in ammonia occurred with generally only minor build-up of nitrates.

Nitrate production was non-existent or proceeded at a very low rate once the waste entered the saturated soil. An apparent peaking of nitrate at the well group 15 feet downstream from the cesspool at Site 2 was probably caused because the samples at the 5 feet point (Well 6) were not representative of the waste plume at that location. The general lack of nitrate production in the distances studied is probably caused by low dissolved oxygen levels in the vicinity of the sewage slug and by the kinetics of aerobic decomposition wherein nitrification is predominately in a late stage of BOD satisfaction. The available free ammonia discharged from the disposal system is, therefore, not yet oxidized to nitrate within the limited distances of the saturated soils observed in the study.

A summary of concentrations of the nitrogen constituents at various points in test sites is shown in Table 4-8.

Table 4-8

Average Concentrations of Nitrogen Products in Disposal Systems
and in Saturated Soil Downgradient

		<u>Average Concentration (mg/l as N)</u>																	
		<u>Test Product:</u>									<u>Sucrose</u>								
		<u>ABS</u>			<u>LAS₁</u>			<u>LAS₂</u>			<u>AS</u>			<u>Soap</u>			<u>Ester</u>		
<u>Site</u>	<u>Form of Nitrogen</u>	<u>Sampling Point: *</u>																	
		<u>A - B - C</u>			<u>A - B - C</u>			<u>A - B - C</u>			<u>A - B - C</u>			<u>A - B - C</u>			<u>A - B - C</u>		
1	Free NH ₄	80	45	22	69	64	21	73	48	34	64	45	Unk	64	32	10			
	NO ₂	0	1	1	0	0	0	0	1	0	0	1	Unk	0	1	0			
	NO ₃	0	0	0	0	5	2	0	40	7	0	30	Unk	0	40	4			
2		51	60	50	57	58	52	60	62	11	50	60	48	61	70	35	60	61	12
		0	0	0	0	0	0	0	0	0	0	0	0	0	0	0	0	0	0
		0	0	0	0	0	0	0	0	5	0	4	3	0	1	3	0	0	1
3		90	30	12	83	25	12												
		0	0	0	0	0	0												
		0	60	60	0	25	43												
4					99	1	1							115	5	1			
					0	1	1							0	0	0			
					1	5	11							0	25	25			
5		62	37		61	34					79	26		81	27				
		0	0		0	0					0	0		0	0				
		0	24		0	19					1	33		0	28				
6		68	48	68	102	57					96	73		94	75				
		0	0		0	0					0	0		0	0				
		0	0		0	1					0	5		0	1				

*Sampling Point: A: Disposal System (Septic Tank or Cesspool). B: First Well Group in Saturated Soil.
C: Last Well Group in Saturated Soil.

Sulfates

Sulfate levels generally increased from the cesspools to the first downstream well group. Values in the ground water directly beneath the tilefields at Sites 5 and 6 were erratic. At Site 5 levels were three to thirteenfold higher than in the septic tank. At Site 6, all values were lower than in the septic tank but the percent reduction varied in the approximate range of 20 to 75 percent.

Movement of the waste slug in the saturated soil zone (first to last well groups) resulted in increasing sulfate levels attaining peak concentrations at varying distances downstream from the cesspool except on Site 3. Sulfate concentrations on Site 3 remained relatively constant throughout all downstream sampling points.

Sulfate levels decreased at variable rates in the downstream flow path beyond the well group exhibiting peak sulfate concentrations. Average net sulfate reductions in this flow distance are shown in Table 4-9.

The reduction in sulfates on Site 1 through the downstream flow path was primarily due to dilution. On Sites 2, 3, and 4, dilution and other factors were effective in causing sulfate reductions in downstream wells subsequent to peak sulfate levels.

High sulfate concentrations still persisted on all cesspool sites at the final observation well groups. Generally, sulfate levels at the last well groups were greater than observed sulfate content in the cesspools and background sampling wells.

LAS surfactant, on Sites 1 and 2, was used on two separate occasions. Each time LAS was used as the household washing compound, on a particular site, a different average sulfate level resulted in the cesspool. Largest cesspool sulfate concentrations always occurred with the initial use of LAS surfactant.

Table 4-9

Sulfate Reductions in Saturated Zone

<u>Test Product</u>		<u>ABS</u>	<u>LAS₁</u>	<u>LAS₂</u>	<u>Soap</u>	<u>AS</u>	<u>Sucrose Ester</u>
Site	Bkgd Conc. (mg/l)	Conc. ¹ - % Red. ²	Conc.- % Red.	Conc.- % Red.	Conc.- % Red/	Conc.- % Red.	Conc.- % Red.
1	19	36-INCR	126-0.03	29-0.30	40-INCR	_____	_____
2	52	177-0.50	65-1.10	11-1.13	8-INCR	32-0.61	29-0.33
3	10	34-INCR	11-0.30	_____	_____	_____	_____
4	31	_____	51-0.23	_____	12-4.12	_____	_____

1. Average Cesspool Concentration (mg/l)
2. Percent reduction through saturated flow path (percent/foot)
Reduction is measured downstream from the test well with peak sulfate concentration.

Phosphates

There was no significant differences in ortho and total phosphate levels in the disposal systems and downstream observation wells, indicating lack of poly-phosphate forms in the background water or in the system. The presence of phosphates is caused predominantly by orthophosphates in synthetic detergent compounds. Inorganic phosphorus in human wastes is negligible.

Phosphate levels found in the disposal systems were generally in amounts larger than calculated from quantities of each test washing compound used. This discrepancy is attributed primarily to the presence of phosphate in dishwashing compounds, use of which was not controlled, and the non-uniform rate of consumption of laundry detergents. A summary of calculated and actual phosphate levels is shown in Table 4-10.

Phosphate removals at the two tile field sites, averaged 86 percent, which was in order of twice the removals at the four cesspool sites measured from system to initial downgradient sampling points. The relative efficiency of the percolation fields is probably due to the larger area of soil-sewage interface available and the larger cross-sectional area of the flow path in the unsaturated zone. These features respectively would tend to enhance biological efficiency and absorption potential in removing phosphates.

Total phosphates decreased drastically in concentration throughout the entire flow path (disposal system to most remote downgradient observation wells). With the exception of Site 3, extremely low total phosphate levels were observed at the last well groups despite the presence of significant amounts of other sewage constituents. Total phosphates at the final observation wells were:

Site 1	-	(80 feet travel, 240 days)	0.99 - 1.72 mg/l
Site 2	-	(65 feet travel, 97 days)	0.03 - 0.60 mg/l
Site 3		(45 feet travel, 75 days)	1.5 - 24.7 mg/l

Table 4-10

Computed and Actual Phosphates in Disposal Systems (mg/l)

Test Product	ABS	LAS	LAS ₂	AS	Soap	Sucrose Ester
Site	Computed-Actual	Computed-Actual	Computed-Actual	Computed-Actual	Computed-Actual	Computed-Actual
1	112 - 111	63 - 103	57 - 89	66 - 76	18 - 56	- - -
2	101 - 74	57 - 71	63 - 86	86 - 82	17 - 48	112 - 122
3	78 - 88	72 - 66	- - -	- - -	- - -	- - -
4	- - -	63 - 82	- - -	- - -	20 - 57	- - -
5	37 - 63	51 - 58	- - -	66 - 64	6 - 49	- - -
6	85 - 70	36 - 103	- - -	42 - 100	3 - 54	- - -

The lowest rate of phosphate reduction was observed on Site 3. At the last well group, an average of 1.5 mg/l of PO_4 was noted during the use of LAS, and 24.7 mg/l was noted during the use of ABS. The substantial difference in phosphate removal during ABS use is explained by the higher initial phosphates in the disposal system. The phosphate level during ABS use was 88.3 mg/l in the cesspool and for LAS was 66.5 mg/l, which accounts for the approximately 20 mg/l difference.

The rate of phosphate reduction in the saturated soil was lower for Sites 3 and 4 than Sites 1 and 2. Phosphate reduction in saturated soils is attributable to the following:

- a. Chemical precipitation and subsequent entrapment of the insoluble precipitate by the soil particles.
- b. Absorption on soil particles.
- c. Bacterial utilization. It is believed that the factors of chemical precipitation and absorption are approximately the same for all sites. Bacterial populations in the unsaturated soils however, are significantly lower on Sites 3 and 4, which would minimize the reduction of phosphates due to bacterial utilization. The large initial reductions on Site 4 are believed to be primarily due to the markedly finer-grained subsoil. It should be noted that once the phosphates entered the saturated soils, phosphate reduction rates were similar to Site 3 and lower than Sites 1 and 2.

Based upon net phosphate reduction rates, it is apparent that factors other than dilution alone contribute to the reduction of inorganic phosphorus, in travel through the saturated soil zone.

Coliform Organisms

The reduction in coliform concentrations at the test sites varied from site to site, and was generally greater for longer flow paths (unsaturated and saturated)

and for finer soil. The concentration of coliforms was in excess of drinking water standards at the most remote downstream sampling point (80 feet) and at the test wells reflecting background conditions.

Travel of the sewage slug through 12 to 15 feet of unsaturated soil resulted in log average coliform densities at the first downstream wells of:

Site 3 - (20 feet vertical travel) 202 to 239 per 100 ml.

Site 4 - (12 feet vertical travel) 76 to 464 per 100 ml.

Where the cesspool effluent traveled through from 0 to 5 feet of unsaturated soil to the ground water (Sites 1 and 2), log average coliform densities at the first well groups were a thousandfold higher:

Site 1 - (5 feet travel) 2.1×10^4 to 2.1×10^7 per 100 ml.

Site 2 - (5 feet travel) 5.1×10^4 to 2.07×10^6 per 100 ml.

The coliform densities observed in the ground water below the two tile field sites averaged between 610 and 1300 MPN/100 ml for the four test products demonstrating reductions achieved by passage through approximately 5 feet and 2 feet of unsaturated soil at Sites 5 and 6, respectively. These removal efficiencies are superior to those at cesspool sites by a factor of 1,000.

Generally, coliform populations were reduced in passage to each subsequent downstream well group on Sites 1 and 2, where waste discharges reached the ground waters with little or no intermediate travel through unsaturated soil. After passing through the unsaturated sands at Sites 3 and 4, relatively small, further coliform reductions occurred through the remaining saturated zone flow path.

Overall coliform and phosphate reductions, cesspool to final well group, achieved about the same order of magnitude, i.e., greater than 98 percent.

Where large reductions in coliform variations occurred between cesspool and first well group, correspondingly large reduction in MBAS levels also took place. Exceptions occurred on Site 2, where cesspool to first well coliform and MBAS

reductions were minimal.

Although extremely large coliform reductions resulted in travel through the unsaturated zones, log average coliform concentrations at the final observation wells on all sites did not differ significantly.

Site 1	(80 feet travel distance)	13.7 to 4724 per 100 ml.
Site 2	(65 feet travel distance)	24.1 to 640 per 100 ml.
Site 3	(45 feet travel distance)	24.8 to 85.7 per 100 ml.
Site 4	(31 feet travel distance)	17.4 to 169 per 100 ml.

At the final observation wells, log average coliform concentrations greatly exceeded allowable standards for an acceptable water supply.

The persistence of coliform organisms in ground water travel was exhibited by high coliform concentrations in those upstream sampling wells which also contained other sewage constituents. Background wells on Site 1 were positive for coliform, although located more than 500 feet downstream from any other sewage disposal systems.

Wells not showing other evidences of sewage contamination were also relatively free of coliform organisms.

A summary of coliform data is shown in Table 4-11.

Alkalinity

Alkalinity levels in the disposal systems on all sites varied during use of each surfactant.

Movement of the sewage slug through the unsaturated soil zones (disposal system to first well group) of Sites 3 and 4 resulted in extremely large reductions in alkalinity. Data was not obtained to depict changes in alkalinity at various levels of the unsaturated zone.

At the two percolation field sites, alkalinity in the ground water beneath the systems varied considerably with no regularity. A low average of 150 mg/l was

Table 4-11

Average Coliform Density (Log Average MPN/100 ml)

Site	Background	Disposal System (X 10 ⁶)	Initial Ground Water Sampling Point (X 10 ³)	Final Well Group	Travel Distance In Saturated Zone (feet)
1	< 2.2	5.2 - 133	21 - 21,000	13.7 - 4,724	80
2	45	1.2 - 10.2	51 - 2,070	24.1 - 640	65
3	13	8.6 - 16.5	0.20 - 0.24	24.8 - 85.7	45
4	1839	3.5 - 6.3	0.08 - 0.46	17.4 - 169	31
5	41	1.7 - 5.9	-	-	-
6	496	4.3 - 18	-	-	-

< Less than

observed at Site 5 during soap tests and a high value of 489 mg/l at Site 6 during ABS use. Percent removal at both sites were consistent at 35 during LAS use. The removal at Site 5 was twice that at Site 6 during AS use (66 percent) and was three-fold that at Site 6 during ABS tests (45 percent). During soap tests, the removal at Site 5 was 69 percent while the alkalinity at Site 6 actually increased in value by 34 percent.

Reduction characteristics of alkalinity in the saturated soil zone varied. Generally, relatively uniform rates of alkalinity reduction occurred through the downstream flow path except during use of the final three surfactants on Site 2. With the use of soap, LAS₂ and AS on Site 2, significant increases in the alkalinity reduction rate resulted beyond 25 feet downstream from the cesspool.

Net alkalinity reduction rates in the saturated soil zones, i.e., after compensating for dilution based upon reductions in chloride concentrations, varied for each site. Generally, dilutional effects alone accounted for the net alkalinity reductions on Sites 1 and 2, except during the use of the final three surfactants on Site 2. Factors other than dilution were involved in reducing alkalinity content on Sites 3 and 4 and during the use of the final three surfactants on Site 2.

Upgradient and downstream observation wells showing evidence of sewage pollution were higher in alkalinity content than those wells free of pollution.

Specific Conductance

Specific conductivity in the disposal system varied with the use of each surfactant. There was; however, a tendency for the specific conductance, on a particular site, to increase with the use of each succeeding surfactant.

In the cesspool, there was no consistent relationship or ratio between total dissolved solids and the specific conductance.

Significant reductions in specific conductance resulted in travel through the unsaturated soil zones of Sites 3 and 4.

Generally, in the downstream saturated soil zones, specific conductivity tended to reduce in level at each subsequent downstream well group except on Site 4. Conductivity reduction rates on Sites 1 and 2 decreased with each downstream well. On Site 4, conductivity measurements increased to well group 10 (21 feet downstream from the cesspool), then decreased rapidly to the final observation group.

There was apparently no consistency in specific conductance reduction rates for the various test sites. Reduction rates were smaller where the waste was discharged directly into the saturated zone than Sites 3 and 4, where the waste first traveled through a zone of unsaturated sands prior to entering the saturated sands.

In the saturated soil zone, dilutional effects resulted for the entire reduction of specific conductivity on Sites 1 and 2, (where discharge is directly into ground waters). On Sites 3 and 4, factors besides that of dilution were effective in reducing conductivity levels in the saturated zone.

Chemical Oxygen Demand

Significant COD reductions were observed in passage of waste through the sewage-soil interface at all cesspool sites, and represent a measure of the removal of organic matter in the sewage.

COD reduction continued as the wastes traveled through the saturated soil zone. Soluble COD was removed to a greater extent at the sewage-soil interface than in the saturated soil zone.

Rates of reduction on Site 2 in the saturated zone was twice as great during tests of Sucrose Ester surfactant than any other surfactant studied.

COD levels in the disposal system did not appear to be consistent with normal maximum 1:1 ratio of BOD to COD.

Generally, factors besides that of dilution alone were effective in reducing COD in the saturated soil zone.

Photograph 4-1

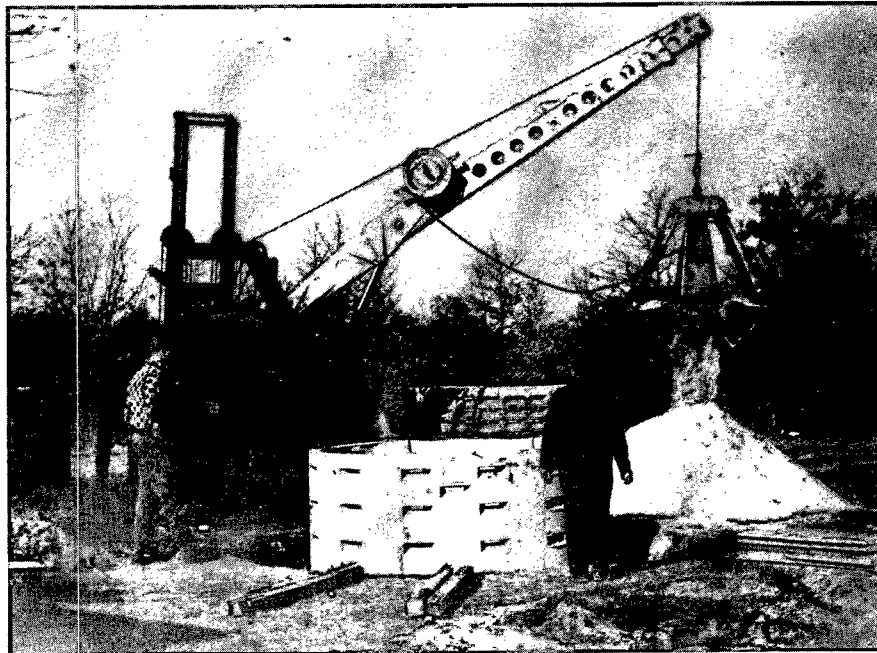

Bailing in Sampling Shaft Site 3

Photograph 4-2

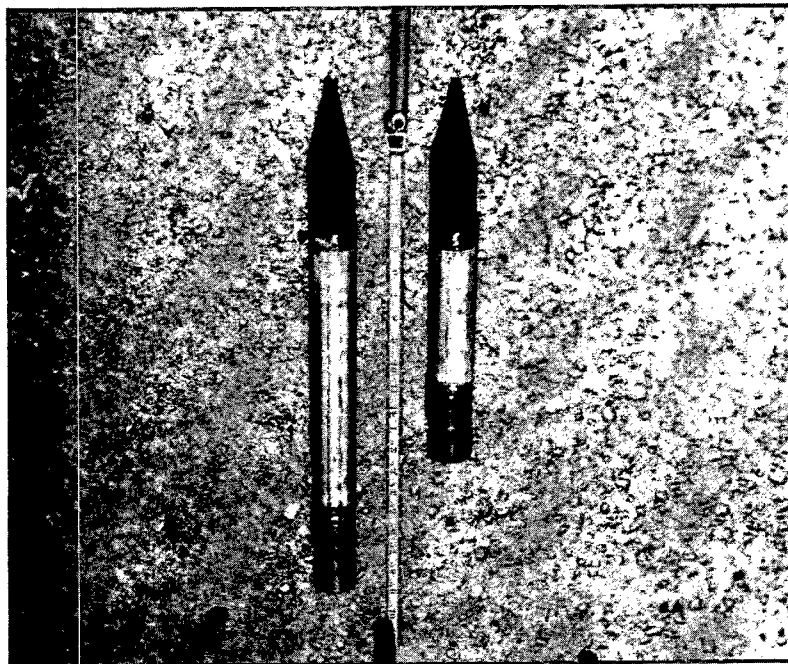

Well Points in Study

2 7
Photograph 4-3



Collection of DO Samples From Modified Pump

Photograph 4-4



Organization of Samples on Site
for Split with Participating Laboratories

PART 5 - SITE 1

Located on the east side of Fireplace Neck Road between Beaverdam Road and South Country Road in the hamlet of Brookhaven, Town of Brookhaven, Suffolk County, the parcel consists of 2.24 acres situated on the glacial outwash plain near Great South Bay. (Figure 5-1) Ground surface elevation near the residence is approximately 11 feet above mean sea level. The family consists of 2 adults and 3 children.

Preparation of the site was initiated in October 1962. The water supply system serving the residence consists of an 1 1/4 inch wrought iron well with a 5 foot stainless steel screen driven to approximately 40 feet below grade and an 80 gallon compression tank. A 3/4 x 5/8 Neptune water meter on loan from the Suffolk County Water Authority was installed immediately adjacent to the compression tank with weekly readings indicating an average consumption of 1,580 gallons per week over the two-year period the site was active. (Table 4-3) The homeowner commenced the use of the packaged formulation containing branched-chain ABS on October 15, 1962.

The sewage disposal system consists of two cesspools 8 feet in diameter and 8 feet deep, of concrete block construction, the lower course of each pool in ground water. The first pool receives the wastes from the kitchen sink, clothes-washer, dishwasher and main bathroom. The second pool receives wastes from the overflow from the first pool and sewage from the second bathroom off the master bedroom. Initial inspection upon uncovering the pools indicated that the first pool was full and overflowing to the second pool. Subsequent samples from the pools and observation wells indicated substantial leaching from the first pool despite its overflowing.

The first investigation on the site was the drilling of a core boring to establish the geological characteristics of the area. The boring was sunk to a depth of 39 feet below grade and spoon samples were attempted every 5 feet and wash samples every 2.5 feet. A total of 12 wash and 3 core

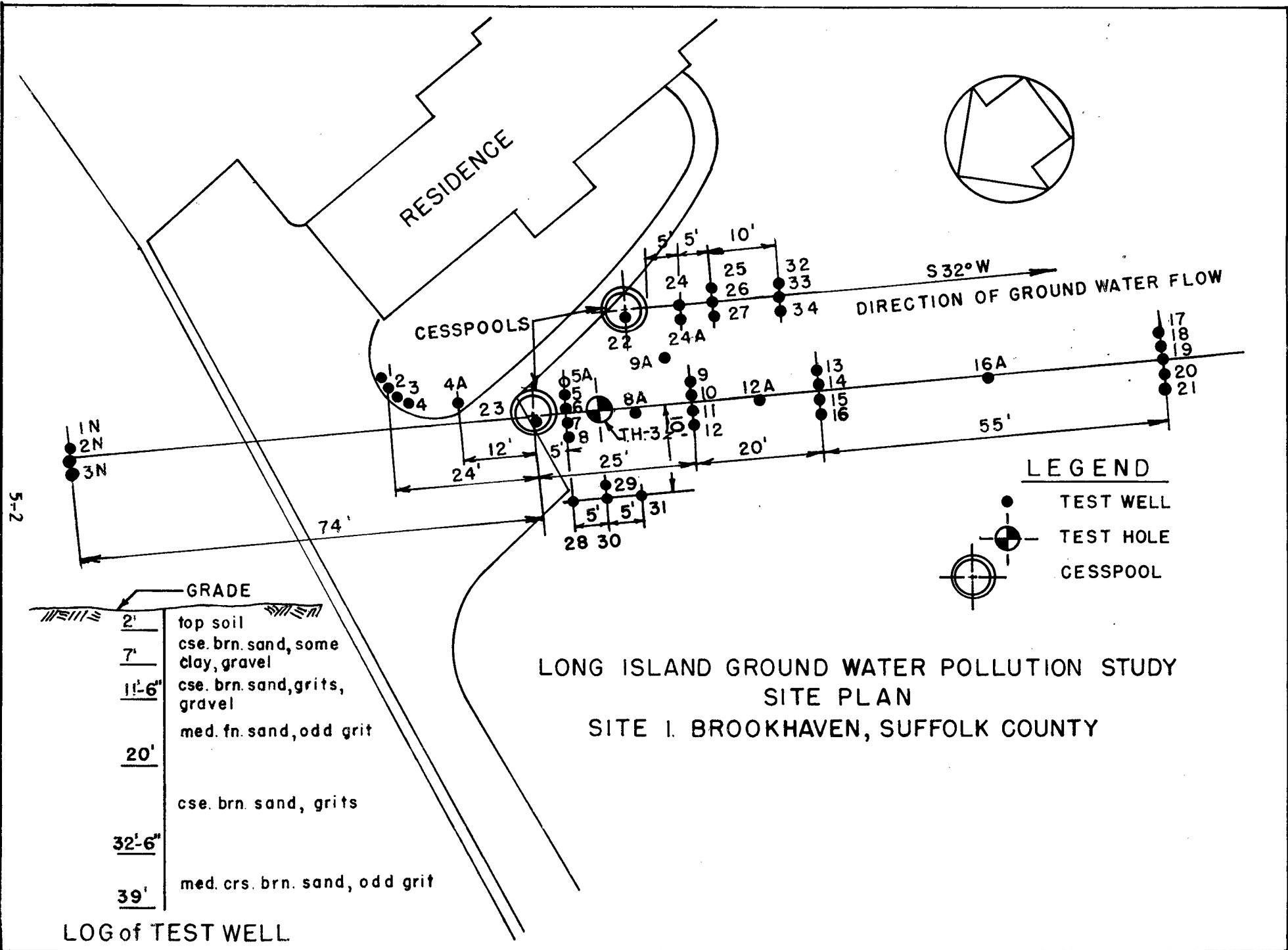
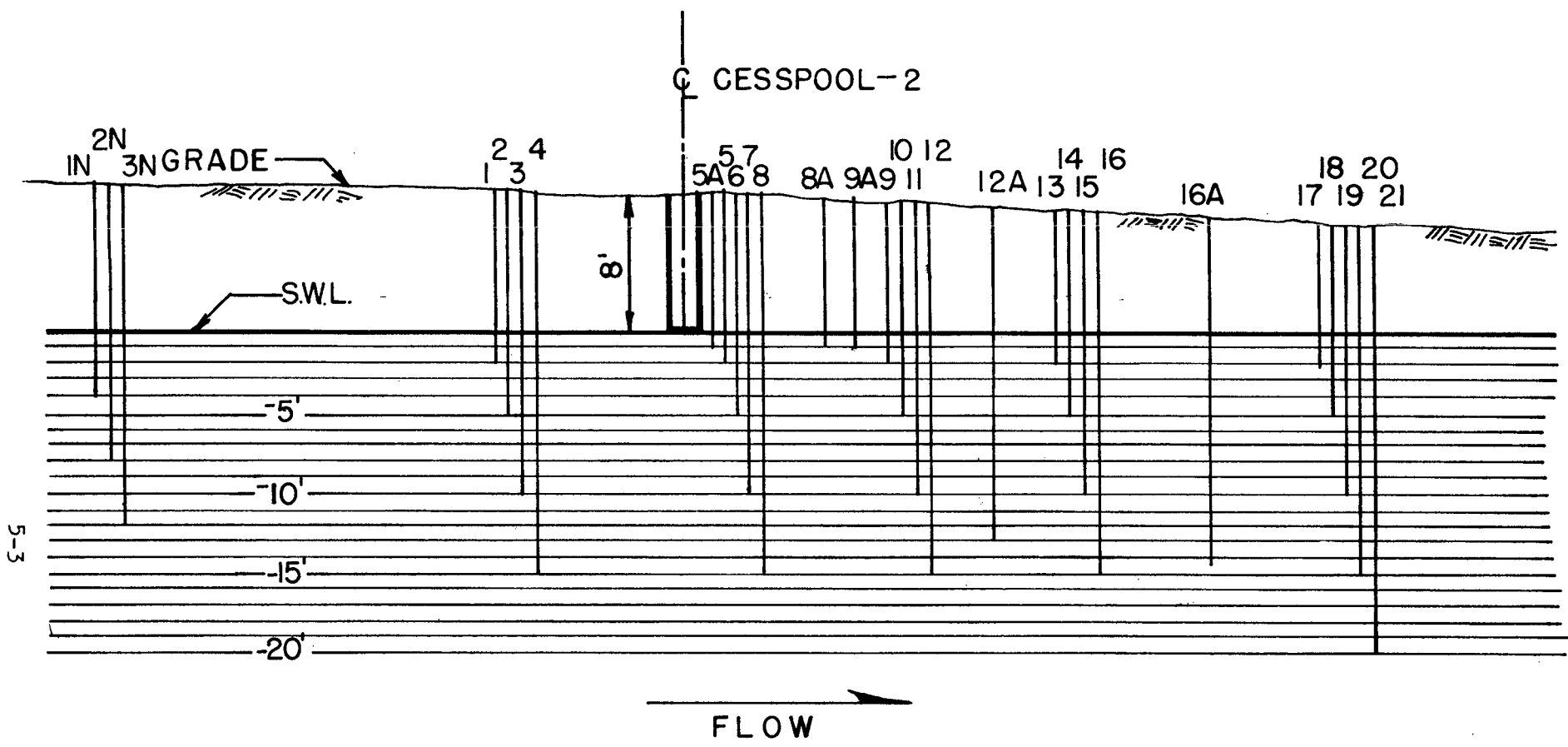
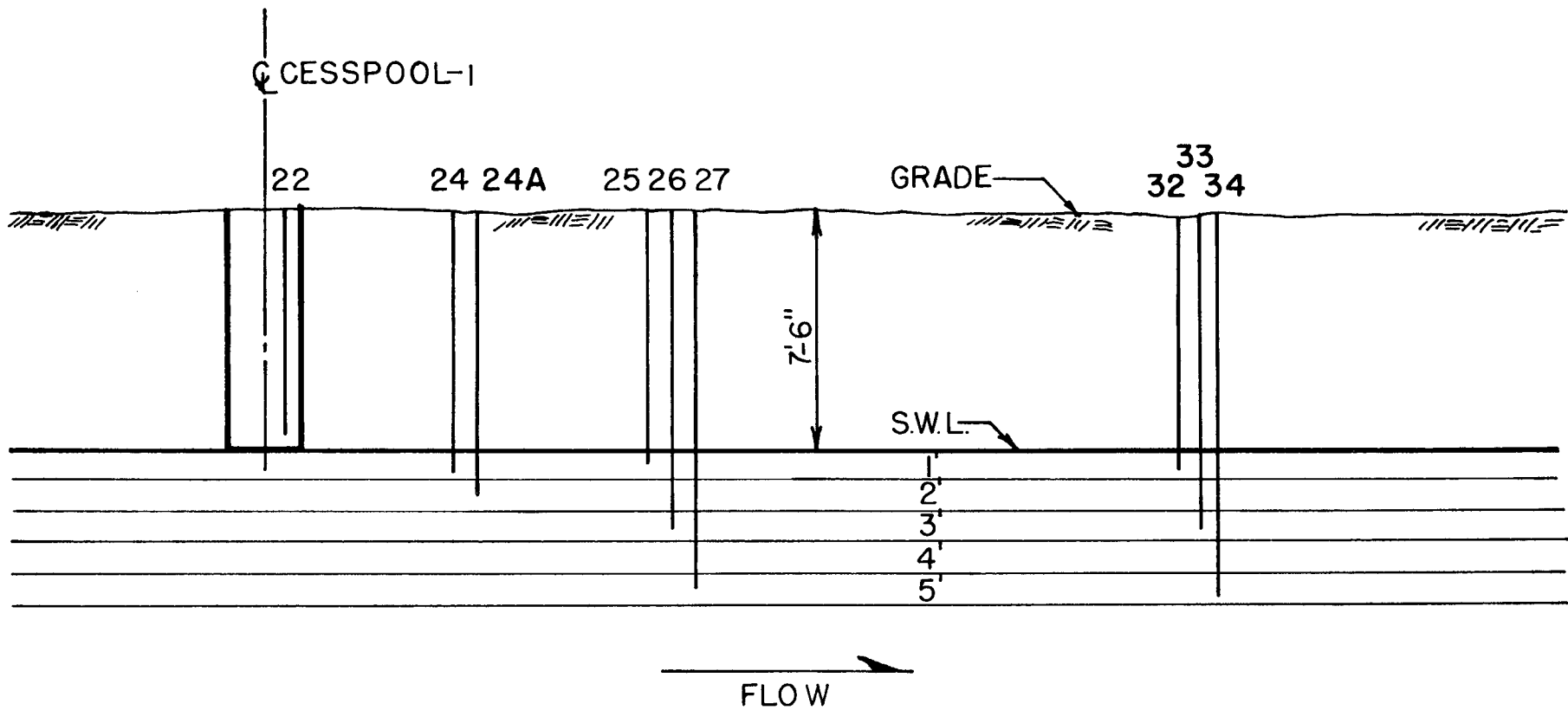

FIG. 5-1



LONG ISLAND GROUND WATER POLLUTION STUDY
 PROFILE TEST WELL
 SITE I. BROOKHAVEN, SUFFOLK COUNTY



5-4

LONG ISLAND GROUND WATER POLLUTION STUDY
 PROFILE TEST WELL
 SITE I. BROOKHAVEN, SUFFOLK COUNTY

FIG. 5-3

samples were retrieved. Representatives of the U.S. Geological Survey examined the samples in the field and the results summarized in Table 5-1 show the subsoil to consist of clean, medium to coarse sand and gravel. Two cores were shipped to the U.S. Geological Survey Laboratory at Denver, Colorado for analysis, results of which are tabulated in Table 5-2.

TABLE 5-1

Geologist's Log of Test Hole at Site 1
Brookhaven, Suffolk County, N.Y., Oct. 22-23, 1962

<u>Depth</u> (feet below land surface)		<u>Core</u> <u>Recovery</u> (inches)
5-6 feet	Sand, fine to coarse, some fine to medium gravel up to about 1" diameter, light br.	10
10-11.5	*Sand, fine to coarse, some fine to medium gravel, light brown.	7
15-16.5	**Sand, fine to medium, few small pebbles, light brown.	6
19-21.5	Sand, fine to medium, fine gravel, light brown (pebbles up to 1/4 inch).	(wash)
22.6	Same as previous description, some pebbles up to 1/2 inch.	(wash)
25-26.5	Sand, fine to coarse, fine gravel, light brown.	(wash)
30-31.5	Sand, fine to coarse, fine gravel, light brown.	(wash)
35-36.5	Sand, fine to medium, some coarse grains, light brown.	(wash)
37	Sand, fine to very coarse, light brown, few pebbles up to 1/4 inch.	(wash)
37-38.5	Same as previous description	(wash)
*	Core sample sent to Denver Laboratory for analyses,	(Field 1) (62NY-8)
**	Core sample sent to Denver Laboratory for analyses,	(Field 2) (62NY-9)

TABLE 5-2

U.S. Geological Survey, Denver, Colorado

Summary of Laboratory Analysis Data for Samples for Project 423700

(Site #1 - Brookhaven, N.Y.)

Laboratory Sample Number	Field Number	Depth (feet)	Specific Gravity of Solids	Dry Unit Weight (g per cc)	Centrifuge Moisture Equivalent (Percent)	Specific Retention (Percent)	Total Porosity (Percent)	Specific Yield (Percent)
62NY8 ^a	1	10-11.5	2.68	1.67	0.3	1.5	37.7	36.2
8 ^b	do	do	2.68	1.68	----	----	37.3	----
9 ^a	2	15-16.5	2.67	1.65	.3	1.5	38.2	36.7
9 ^b	do	do	2.67	1.63	----	----	39.0	----

a De-aired H₂O water

b Sewage effluent

Four ground water level observation wells were installed on the site and survey teams from the Suffolk County Health Department, under the supervision of the U. S. Geological Survey, accurately determined ground water elevations. The slope of the water table was then plotted and the direction of ground water flow estimated at South 32° West.

A series of probe wells were driven along the indicated line of flow and sampled at various depths to delineate the sewage slug. Five wells, totaling 94 feet of penetration were drilled and sampled at 5, 10, 15 and 25 feet below static water level. Using a field kit, waters from the probe wells were examined in the field for methylene blue active substances.

On the basis of the field analyses, subsequently confirmed by laboratory determinations, the position and depths of the permanent observation wells were established. Twenty-one wells were installed along the estimated ground water direction gradient line intersecting the second pool. The wells were installed in 5 groups, the first group being 24 feet northeast of the disposal system as background wells to monitor the quality of the ground water approaching the system, and the remaining four groups, 5, 25, 45 and 100 feet down the hydraulic gradient. Each group consisted of wells of 1 1/4 inch diameter with 12-inch effective screen openings centered 2, 5, 10 and 15 feet below static water level. An additional well was installed 20 feet below static water level at the farthest group 100 feet downstream. (Figure 5-1, 2, 3)

Examinations of the data obtained after the first three weekly samplings pointed to some unexpected problems requiring further investigation. A significant concentration of some sewage constituents was found underlying the sewage slug separated by uncontaminated water, and also appearing in well No. 3, the deepest of the group upstream from the

cesspool. In addition, it was noted that the wells immediately adjacent to the overflow or second cesspool exhibited lower concentrations of some constituents than a number of the wells further downstream.

To investigate the Task Group's conclusion of offsite sources of the underlying contaminants, a second series of upstream wells was installed 50 feet further northeast and designated wells No. 1N, 2N and 3N, and driven 4, 8 and 12 feet below static water level. Subsequent analyses of these wells confirmed the narrow band of background contamination traveling from a pollutional source or sources upgradient of the site. It is interesting to note that the neighboring property is a horticultural nursery and that the nearest cesspools in the established flow direction to pass through this site are more than 600 feet distant. The Task Group also concluded that the first cesspool was apparently leaching a substantial volume of waste contrary to our previous assumption. Accordingly, the well rig was returned to the site and additional wells placed for the purpose of further identification and analysis of the flow pattern. (Figure 5-1, 2, 3) Well No. 5A was driven adjacent to cesspool No. 2 using a 6-inch effective opening screen, its top slot placed 6 inches below static water level. It was also concluded that the plume of contaminants did not penetrate the ground water environment near the source so that well No. 8A was installed midway between the first and second groups of downstream wells and also 6 inches below static water level. To determine the effect and extent of leachings from the first cesspool, well No. 9A was driven 6 inches below static water level at a location midway between the cesspool and the group including wells No. 9, 10, 11 and 12.

Subsequent analyses and other considerations forced the conclusion that the major source of surfactant-bearing wastes was the first cesspool.

A second series of wells was thereupon placed parallel to the original group on a directional line passing through the center of cesspool No. 1

In February 1963 well No. 24 was installed 5 feet from the pool and to a depth of 12 inches below the static water level. Wells 25, 26, and 27 were driven in a group 10 feet downgradient from the edge of the cesspool to depths 1, 2 and 4 feet below static water level, respectively. In July 1963 wells 32, 33 and 34 were driven to depths of 9", 2'6", and 4'6" into the water table in a group of 20 feet from the cesspool, and well No. 24A at a point midway between well No. 24 and the next group, 1'6" below static water level. All of these wells were incorporated into the routine sampling schedule. Due to the difficulties encountered with the confusing waste flow pattern from the two interconnected cesspools at this site, consideration was only given to those future sites which employed a single cesspool or septic tank and leaching pool or tile drainage fields.

Velocity Measurements

Several tracer methods were evaluated on this site to determine ground water velocity. On November 26, 1962 one liter of a solution containing 20,000 parts per million of hexavalent chromium was introduced into well No. 5A, followed by sufficient water to flush the well casing. Samples were pumped from wells No. 8A, 9, 10, 11 and 12 on successive days to time the passage of the chromium tracer to downstream wells. No chromium was recovered during this or succeeding sampling periods. On March 2, 1963 a hexavalent chromium tracer was placed directly in cesspool No. 1. No chromium was detected in well No. 5A or other observation wells near this pool. Five ppm of hexavalent chromium was added to a somewhat turbid sample from well No. 24. Only 1.6 ppm chromium was detected upon immediate analysis, and after 30 days storage, analysis indicated 0.6 ppm present in the hexavalent state. It was concluded that the hexavalent chromium was being adsorbed on the subsoils or other materials in the disposal system.

Another attempt was made to establish the ground water velocity utilizing fluorides. On January 2, 1963 three pounds of sodium fluoride was dissolved in hot water and introduced into cesspool No. 2. Downstream wells were

sampled and analyzed. Fluorides appeared in well No. 8A, 10 feet distant from the edge of the cesspool on February 4, 1963. The velocity was computed to be 0.33 feet per day. On March 18, 1963 fluoride was detected in well No. 9 for a travel time of 75 days for a total distance of 21 feet or a velocity of 0.28 feet/day.

In May of 1963 four tracer wells were installed 15 feet distant and parallel to the direction of flow to confirm the velocity factor. Well Nos. 28 and 31 are 6 inches in diameter and well Nos. 29 and 30 are 4 inches in diameter. All were constructed of polyvinyl chloride tubing with 1/16 inch diameter holes drilled on 1 1/2 inch centers in the bottom 12 inches to permit transfer to formation water. All four wells were placed 12 inches into the water table.

One pound of sodium chloride was introduced to well No. 28 on June 6, 1963. The wells were sampled daily with a bomb sampler lowered into the water and opened by a messenger from the surface. The chloride content of the ground water stayed within a range of 3 parts per million until it doubled on June 21 followed by gradual increases on succeeding days. The travel of 5 feet in 15 days confirmed the velocity of 0.33 feet per day determined using fluorides.

Travel of Waste Slug

1. Depression of the waste slug occurred as the waste traveled through the downstream flow path. Initially, at the first well group, the slug was located approximately 2-5 feet below static water level and depressed to about 10 feet below SWL in a horizontal travel distance of 75 feet.
2. In travel through the downstream wells, the sewage slug generally decreased in concentration in constituents of sewage origin. The decrease in concentration was due primarily to mixing with less contaminated ground water and other exchange and sorption phenomenon.
3. Density difference between the sewage slug and surrounding ground waters is the primary factor causing depression of the waste slug through the downstream flow path. Natural recharge of the upper glacial aquifer by precipitation did not appear to have a direct affect in either depressing the waste slug or resulting in additional dilution. As mixing and dilution of the slug progresses, density differences are decreased and the downward force driving the sewage-ground water mixture deeper gradually decreases.
4. Background observation wells indicated the presence of an upgradient waste slug located at approximately 12-15 feet below SWL. Through the downstream flow path, the upgradient slug traveled below the slug emanating from the cesspool and was separated by an area of relatively uncontaminated ground water flow. Background observation wells on Site No. 1 were located more than 500 feet downstream from any other sewage disposal system.

Chlorides

1. Average chloride concentrations in the disposal system ranged between 56.5 and 72.6 mg/l. (Table 5-3) Background wells indicated average chloride concentrations of 8.0 and 16.5 mg/l being measured in the observed upgradient waste slug and peripheral ground waters, respectively.
2. In the immediate area of the disposal system (cesspool to first well group) chloride concentrations in the cesspool were reduced from 1.2 to

SITE 1
OBSERVATION WELL CONCENTRATIONS

TABLE 5-3

Velocity=0.33 ft./day	Cesspool	#24	#26	#33	#19
	0	5'	10'	20'	80'
1. ABS (MBAS)	40.1	34.5	48.0		0.60
Ammonia	79.5	78.0	47.0		24.0
Chlorides	69.7	66.0	57.5		22.5
Total PO ₄	111.0	110.0	150.0		1.72
Spec. Cond.					
Alkalinity	470.0	37.0	432.0		127.0
Sulfates	36.0	115.0	86.3		55.3
Coliform	113.8x10 ⁶	3.21x10 ⁵	4.3x10 ⁵		240.0
(Log Avg.)					
Nitrites	0.018	0.05	0.20		0.02
Nitrates	0.12	0.35	1.70		1.40
COD	309.0	206.0	222.0		142.0
2. LAS ₁ (MBAS)	53.4	28.3	16.5		0.62
Ammonia	68.8	65.5	64.0		22.7
Chlorides	72.6	70.8	69.0		26.0
Total PO ₄	103.0	101.0	123.0		0.99
Spec. Cond.	655.0	638.0	652.0		450.0
Alkalinity	375.0	355.0	366.0		179.0
Sulfates	126.1	101.0	81.2		32.0
Coliform	132.8x10 ⁶	21.0x10 ⁶	1.64x10 ⁶		13.7
(Log Avg.)					
Nitrites	0.02	0.03	0.08		0.04
Nitrates	<0.01	0.14	4.30		1.96
COD	281.0	164.0	188.0		40.8
3. Soap (MBAS)	3.48	9.60	6.52	6.31	1.70
Ammonia	64.5	54.6	33.5	19.4	10.4
Chlorides	66.5	63.1	52.8	52.1	23.9
Total PO ₄	55.5	50.1	33.9	21.4	1.22
Spec. Cond.	680.0	642.0	540.0	492.0	248.0
Alkalinity	359.0	343.0	228.0	203.0	116.0
Sulfates	40.4	48.6	58.2	85.7	56.4
Coliform	5.24x10 ⁶	2.12x10 ⁴	5.69x10 ³	1.30x10 ⁴	568.
(Log Avg.)					
Nitrites	0.01	0.47	0.66	0.26	0.056
Nitrates	0.12	27.4	40.7	21.7	3.6
COD	153.0	131.0	97.0	75.2	27.0

SITE 1
OBSERVATION WELL CONCENTRATIONS

TABLE 5-3 (cont.)

	Cesspool 0	#24 5'	#26 10'	#33 20'	#19 80'
4. LAS (MBAS)	21.3	6.04	4.0	5.90	2.5
Ammonia	73.7	54.3	48.0	47.2	35.5
Chlorides	63.0	61.6	58.8	52.2	26.0
Total PO ₄	88.5	64.1	53.5	42.0	1.14
Spec. Cond.	835.0	680.0	608.0	545.0	423.0
Alkalinity	381.0	298.0	259.0	244.0	154.0
Sulfates	29.0	143.0	105.0	112.0	44.0
Coliform	9.02×10^6	5.23×10^4	2.95×10^4	3.82×10^4	4.72×10^3
(Log Avg.)					
Nitrites	0.015	1.46	0.55	0.34	0.13
Nitrates	<0.1	23.7	40.3	13.7	6.7
5. AS (MBAS)	14.6	9.0	7.4	6.7	
Ammonia	64.4	61.5	45.8	41.0	
Chlorides	56.5	55.8	53.2	50.0	
Total PO ₄	76.0	81.0	69.2	60.0	
Spec. Cond.	845.0	758.0	675.0	646.0	
Alkalinity	426.0	341.0	212.0	266.0	
Sulfates	7.8	69.2	63.2	66.3	
Coliform	22.4×10^6	8.24×10^4	4.53×10^4	5.95×10^4	
(Log Avg.)					
Nitrites	0.01	0.44	0.32	0.24	
Nitrates	0.14	21.9	29.9	13.3	
COD					

SITE 1
PERCENT REMAINING OF FIRST WELL CONCENTRATION

TABLE 5-4

	#24 0	#26 5'	#33 15'	#19 75'
1. ABS (MBAS)	100.0	+139.2		1.8
Ammonia		60.2		30.8
Chlorides		87.1		34.0
Total PO ₄		+136.4		1.7
Spec. Cond.				
Alkalinity				
Coliform		+133.6		0.3
(Log Avg.)				
COD		+108.7		69.0
2. LAS ₁ (MBAS)	100.0	58.3		2.2
Ammonia		97.7		34.6
Chlorides		97.5		36.5
Total PO ₄		+121.8		1.0
Spec. Cond.		+102.2		70.5
Alkalinity		+103.1		50.4
Coliform		7.9		0.1
(Log Avg.)				
COD		+112.7		24.5
3. Soap (MBAS)	100.0	67.9	65.7	17.6
Ammonia		61.4	35.6	19.2
Chlorides		83.7	82.6	36.9
Total PO ₄		67.7	42.8	2.6
Spec. Cond.		84.1	76.6	38.6
Alkalinity		66.5	59.2	33.9
Coliform		27.0	61.4	2.8
(Log Avg.)				
COD		74.1	57.4	20.5
4. LAS ₂ (MBAS)	100.0	66.2	97.7	41.4
Ammonia		84.0	86.9	65.4
Chlorides		95.5	84.7	42.2
Total PO ₄		83.5	65.5	1.9
Spec. Cond.		89.4	80.2	62.2
Alkalinity		86.9	81.9	51.7
Coliform		56.2	73.0	9.0
(Log Avg.)				
COD				
5. AS (MBAS)	100.0	82.2	74.4	
Ammonia		74.4	66.7	
Chlorides		95.3	89.6	
Total PO ₄		85.4	74.0	
Spec. Cond.		89.1	67.1	
Alkalinity		62.2	78.0	
Coliform		54.8	72.2	
(Log Avg.)				
COD				

5.3 percent. Due to the variable length of travel, a rate of reduction per foot of travel from cesspool to first well group, was unable to be determined. (Table 5-3, 4)

3. Through the downstream flow path (first to last well groups), (Table 5-3, 4 Figure 5-1, 2, 3, 5-26 through 35) chlorides had an overall reduction of 57.8 to 66.0 percent. The average rate of reduction of chloride concentration in the saturated soil zone was essentially constant during the use of all surfactants. The reduction in chloride concentration was believed to be a measure of dilution accomplished by mixing with ground waters of lower chloride content. The average rates of chloride reduction during use of various surfactants are as follows:

	<u>Average Values</u>		
ABS	0.88%/ft.	0.29%/day	0.58 mg/l/ft.
LAS ₁	0.85	0.28	0.60
Soap	0.83	0.27	0.52
LAS ₂	0.77	0.25	0.48
AS	0.70	0.23	0.39

Infrared Analysis

1. Infrared analysis for the present branched material (ABS) in the downstream wells indicated 88 to 56 percent ABS still present in the soil during the use of soap product. The first infrared samples during the use of soap were collected approximately four and one-half months after ABS surfactant was discontinued as the household washing compound. Prior to the study, the household was using an ABS washing compound; and therefore; it is assumed that all MBAS on the site initially was ABS material.

2. Average percent branched material present at downstream sampling locations during the use of soap material is shown on following tabulations:

(See page 5-18)

LONG ISLAND GROUND WATER POLLUTION STUDY
 REDUCTION VERSUS TRAVEL TIME
 CHLORIDES (10/15/1962-11/30/1964)
 SITE N° 1- BROOKHAVEN, SUFFOLK COUNTY, N. Y.

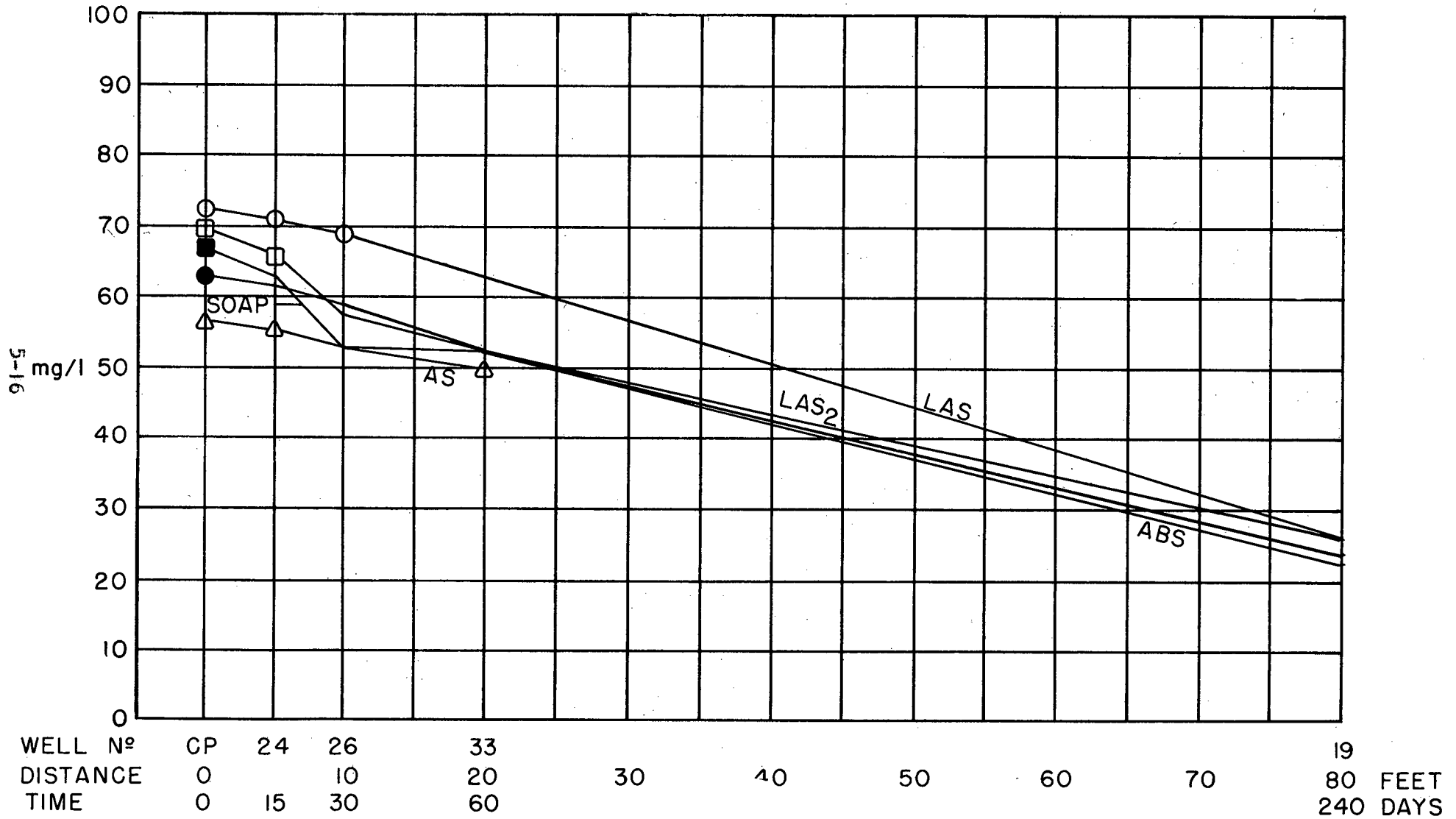

FIG. 5-4

LONG ISLAND GROUND WATER POLLUTION STUDY
 PERCENT REMAINING OF FIRST WELL CONCENTRATION
 CHLORIDES (10/15/1962-11/30/1964)
 SITE N° 1 - BROOKHAVEN, SUFFOLK COUNTY, N. Y.

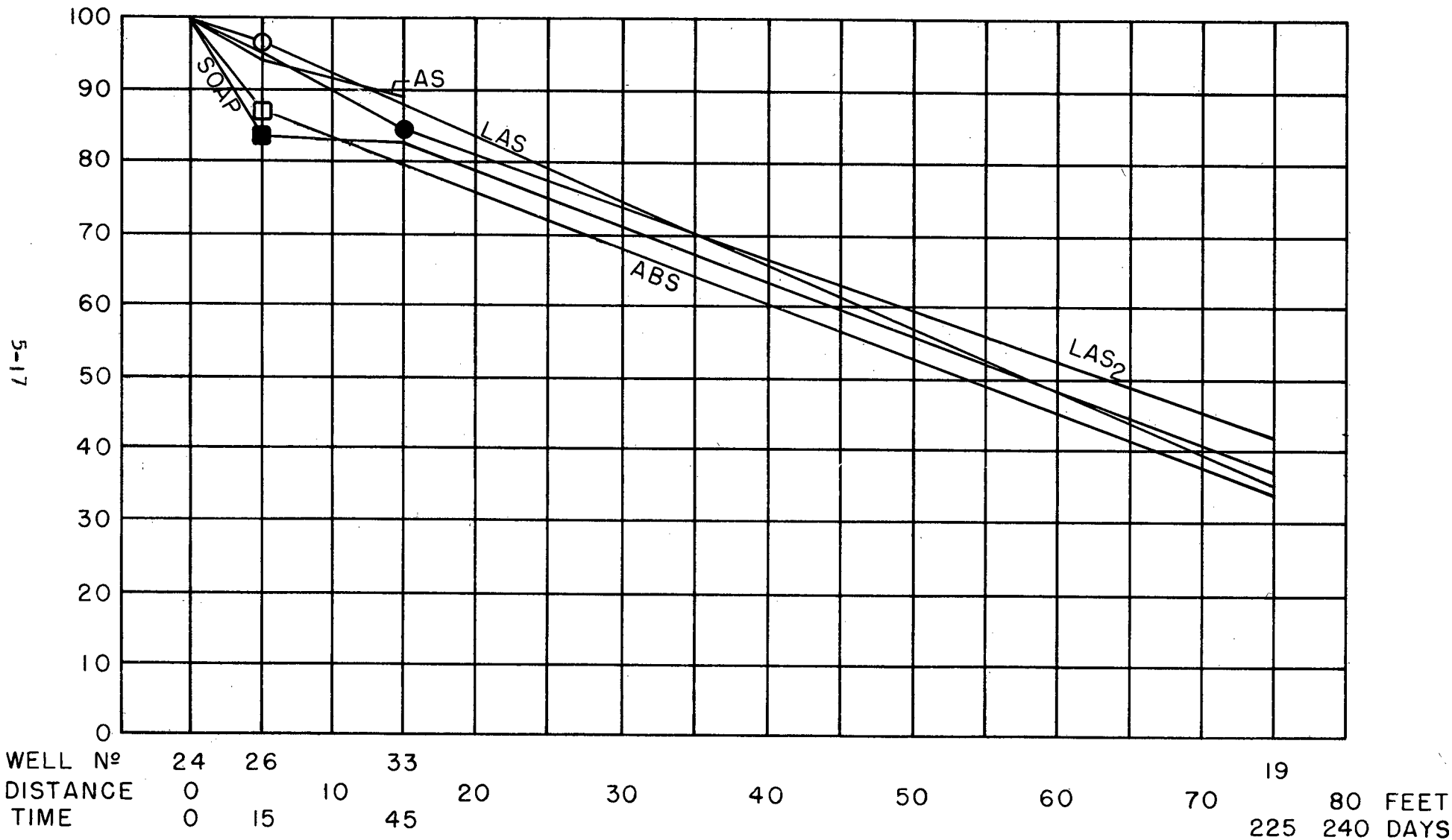

FIG. 5-5

Average Percent Branched Material Present

Sample Date	Well #24 (5')	Well #24 A (5')	Well #26 (10')	Well #32 (20')
7/10/63	75%		75%	
9/9/63		61%	64	72%, 56%
10/8/63			63.5	
10/21/63			58	
12/18/63			62	
1/64			88	
2/10/64			86	

3. About 240 days (8 months) were required for the sewage slug to completely pass through the entire downstream sampling wells. Infrared samples were collected only as far downstream as well #32 or approximately 60 days (2 months) travel time.

Assuming the soil was completely saturated with ABS at the beginning of the study, about 25% of the branched material was flushed out, desorbed, during the time ABS was discontinued as the washing compound and collection of infrared samples (4.5 months). At well #26, a 30-day (1 month) travel distance from the cesspool infrared analysis indicated about a 13% reduction in branched material, ABS, after a 5-month usage of Soap product or after about 5 complete waste slug passes.

4. Generally, the percent branched material, ABS, at well #26 reduced with prolonged time but then increased significantly in January 1964.

5. The infrared samples collected were insufficient to accurately describe desorption characteristics of ABS from the downstream flow path.

MBAS as ABS

1. MBAS reported as ABS in the disposal system varied with the surfactant in use and ranged between 3.5 and 53.4 mg/l. (Table 5-3) Background observation wells indicated MBAS concentrations of less than 0.02 mg/l in wells not showing the presence of the sewage slug, while average concentrations

observed in the slug was 0.30 mg/l.

2. Significant reductions in MBAS concentrations, 14.0 to 71.7 percent, resulted in the movement of the waste slug between the cesspool and first well group, except during the use of soap. With the use of soap, MBAS concentrations increased at the first well group by 176.0 percent. (Table 5-3, 4 Figure 5-6, 7)

3. The increase in MBAS concentrations during soap usage was due to desorption of branched material, ABS, from soil particles in the cesspool region. Approximately 75 percent branched material (ABS) still persisted at the first well group after a 5-month period following discontinuance of ABS. (Figure 5-6, 7 26 through 35)

4. Travel of the waste slug through the downstream saturated soil zone resulted in overall reductions in MBAS concentration during the use of all surfactants. Average rates of reduction in MBAS between the first and final well groups, 75 feet travel distance was:

	<u>Average Values</u>		
ABS	1.31%/ft.	0.43%/day	0.45 mg/l/ft.
LAS ₁	1.30	0.43	0.37
Soap	1.10	0.36	0.11
LAS ₂	0.78	0.26	0.05
AS	1.70	0.56	0.15

5. Compensating for dilutional effects, based upon reductions in chloride concentrations, resulted in net MBAS rates of reduction (% MBAS - % Chlorides) due to factors other than dilution in travel between the first and last well groups of:

ABS	0.43%/ft.	0.14%/day
LAS ₁	0.45	0.15
Soap	0.27	0.089
LAS ₂	0.01	0.003
AS	1.0	0.33

LONG ISLAND GROUND WATER POLLUTION STUDY
 PERCENT REMAINING OF FIRST WELL CONCENTRATION
 MBAS REPORTED AS ABS (10/15/1962-11/30/1964)
 SITE N° 1 - BROOKHAVEN, SUFFOLK COUNTY, N.Y.

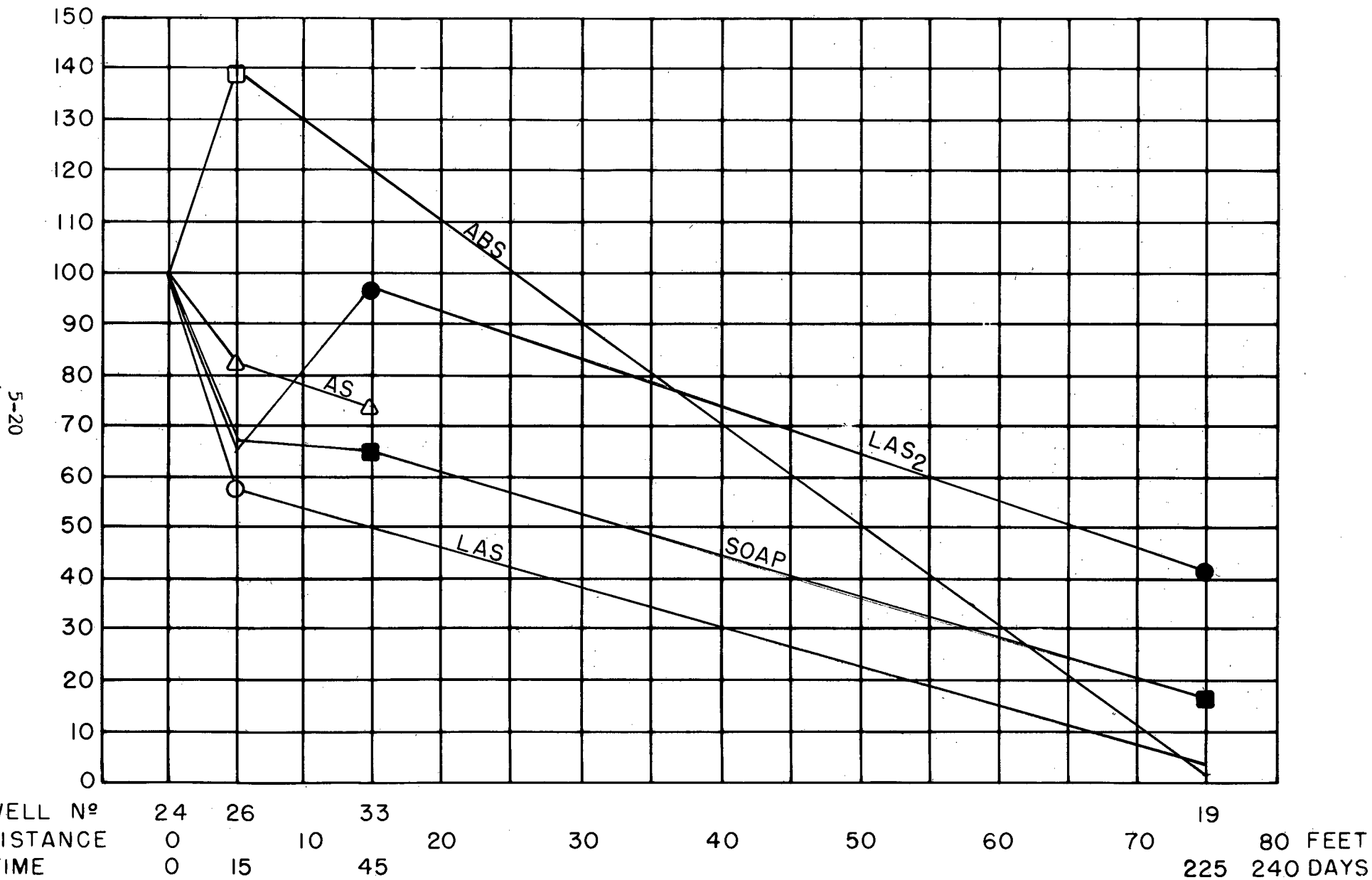

FIG. 5-6

LONG ISLAND GROUND WATER POLLUTION STUDY
 REDUCTION VERSUS TRAVEL TIME
 MBAS REPORTED AS ABS (10/15/1962-11/30/1964)
 SITE N° 1- BROOKHAVEN, SUFFOLK COUNTY, N. Y.

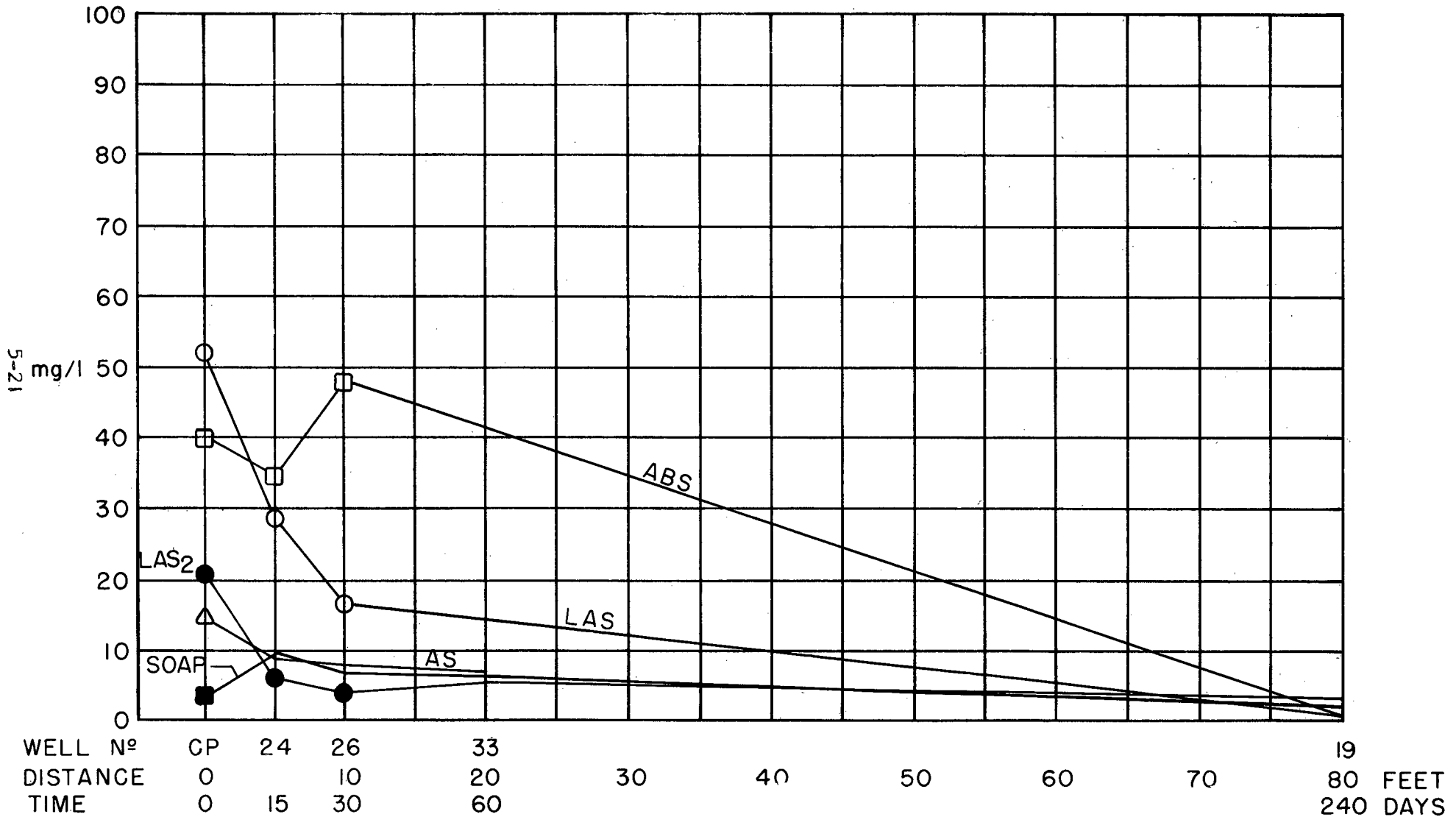

FIG. 5-8

6. The reductions in MBAS are overall reductions and do not distinguish between adsorption and biodegradation.
7. Cognizance must be made that Soap, a non-methylene blue responsive substance, maintained an MBAS level in the disposal system averaging 3.48 mg/l and increased in MBAS concentrations to the first well group, attaining an average MBAS level of 9.60 mg/l. The increase in MBAS concentrations in the cesspool region during the use of Soap was due to desorption of branched material, ABS. MBAS levels in the downstream wells during the use of LAS₂ and AS were in about the same concentration range as Soap; therefore, all reductions and rate functions associated with the use of Soap, LAS₂ and AS materials are undoubtedly subject to interferences by desorbed branched material.
8. Considerable differences in average MBAS concentrations resulted during the use of LAS surfactant on two separate occasions. The second usage of LAS surfactant resulted in significantly lower MBAS levels in the cesspool and downstream well groups.

The second LAS use was preceded by a 37-week use of Soap with the ensuing purgative effect of the low MBAS waste slug, thereby enhancing the adsorptive capacity of the downstream saturated soils. Further, the MBAS levels in the cesspool (21.3 mg/l MBAS) during the second use were considerably lower than MBAS levels in the cesspool during the first use of LAS (53.4 mg/l MBAS).

9. Generally, lower MBAS concentrations in the cesspool and downstream saturated soil zone resulted after changing from ABS to other surfactants. In changing surfactants, it required more than a month for the cesspool and downstream wells to attain steady state conditions.
10. Between the cesspool and well group No. 10, (10' downstream) there tended to be a reduction in MBAS at a generally decreasing rate. Large bacterial populations existed in the first ten feet and decreased at a rapid rate

through this travel distance, but an association between decreases in bacterial populations and reductions in MBAS concentrations was not apparent.

Dissolved Oxygen

1. Average dissolved oxygen concentrations of wells upgradient from the disposal system varied between 0.26 and 4.0 mg/l. The dissolved oxygen was considerably lower, 0.26 to 0.50 mg/l, in the background wells showing evidence of pollution from some upgradient source. Significant average dissolved oxygen levels, 1/5 to 4.0 mg/l, was observed in the remaining background test wells.
2. Downstream observation wells showing the presence of sewage contaminants were virtually void of dissolved oxygen. Peripheral ground waters above and below the waste slug exhibited significant average dissolved oxygen concentrations ranging up to 4.9 mg/l. Wells showing high dissolved oxygen levels were also relatively free from pollution.
3. There was no evidence of re-oxygenation of the polluted ground waters within the downstream distances studied.

pH

1. The pH in the disposal system and observation test wells did not show any significant variation of pH level.
2. Within the cesspool, the average pH range was between pH 6.0 and 6.9. Generally, the background and downstream observation wells indicated about the same pH range (pH 5.9 to 7.1).

Ammonia

1. Free ammonia concentrations within the disposal system were reasonably consistent during the use of all surfactants ranging between 64.4 and 79.5 mg/l. (Table 5-3) Background observation wells indicated average free ammonia concentrations of 4.0 and 0.015 mg/l in the background sewage slug and peripheral ground waters respectively.
2. Significant reductions in ammonia levels resulted in movement of the

waste slug between the cesspool and well group No. 26, 10 feet downstream from the disposal system, except during the use of LAS surfactant. The reduction in free ammonia for this 10 feet initial travel distance was consistent with the increases of other nitrogenous compounds. (Table 5-3, 4 Figure 5-8 through 13, 5-26 through 35)

3. Overall rates of ammonia reduction vary considerably, depending upon the surfactant in use. Generally, the rate of reduction proceeded at a decreasing rate as the waste slug moved through the downstream flow path.
4. Significantly larger reductions in free ammonia concentration resulted during the use of Soap at each sampling location than with other surfactants.
5. The average rate of reduction of free ammonia through the downstream flow path beyond the well group where peak nitrate concentrations developed were as follows:

		<u>Average Values</u>		
ABS	Well #26-19	0.73%/ft.	0.24%/day	0.34 mg/l/ft.
LAS ₁	26-19	0.91	0.30	0.59
Soap	33-19	0.79	0.26	0.15
LAS ₂	26-19	0.36	0.12	0.18
AS	26-33	1.06	0.35	0.48

Compensating for dilution effects, based upon reductions in chloride concentrations indicated that the reduction in free ammonia through this downstream flow path was due primarily to dilution rather than by biological activity.

The net rates of reduction of free ammonia were:

		<u>Average Values</u>	
ABS	Dilution Rate Exceeds Total Reduction Rate		
LAS ₁		0.06%/ft.	0.02%/day
Soap	Dilution Rate Exceeds Total Reduction Rate		
LAS ₂	Dilution Rate Exceeds Total Reduction Rate		
AS		0.36%/ft.	0.12%/day

LONG ISLAND GROUND WATER POLLUTION STUDY
 REDUCTION VERSUS TRAVEL TIME
 AMMONIA (10/15/1962-11/30/1964)
 SITE N° 1- BROOKHAVEN, SUFFOLK COUNTY, N. Y.

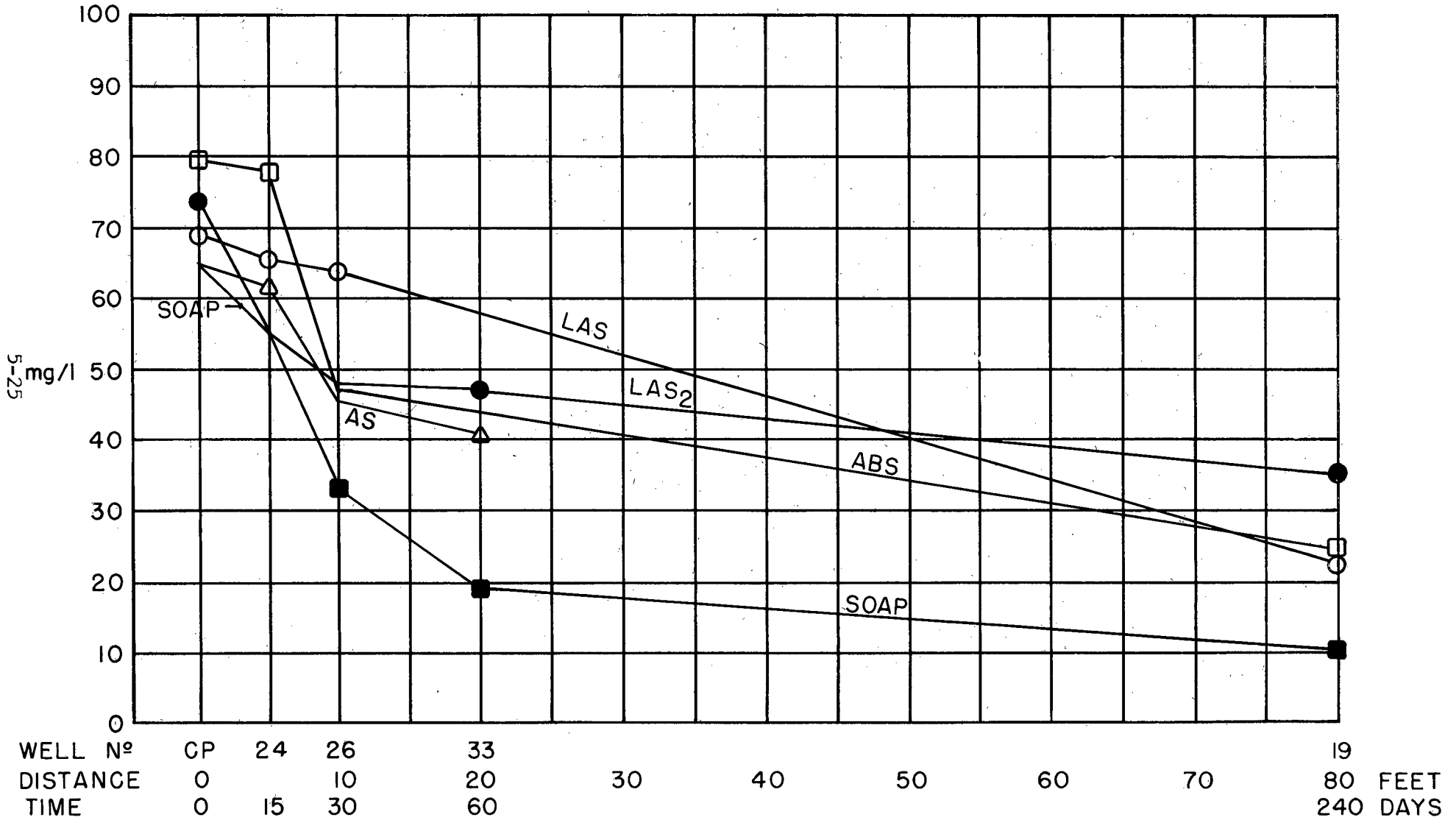

FIG. 5-7

LONG ISLAND GROUND WATER POLLUTION STUDY
 PERCENT REMAINING OF FIRST WELL CONCENTRATION
 AMMONIA (10/15/1962-11/30/1964)
 SITE N° 1 - BROOKHAVEN, SUFFOLK COUNTY, N. Y.

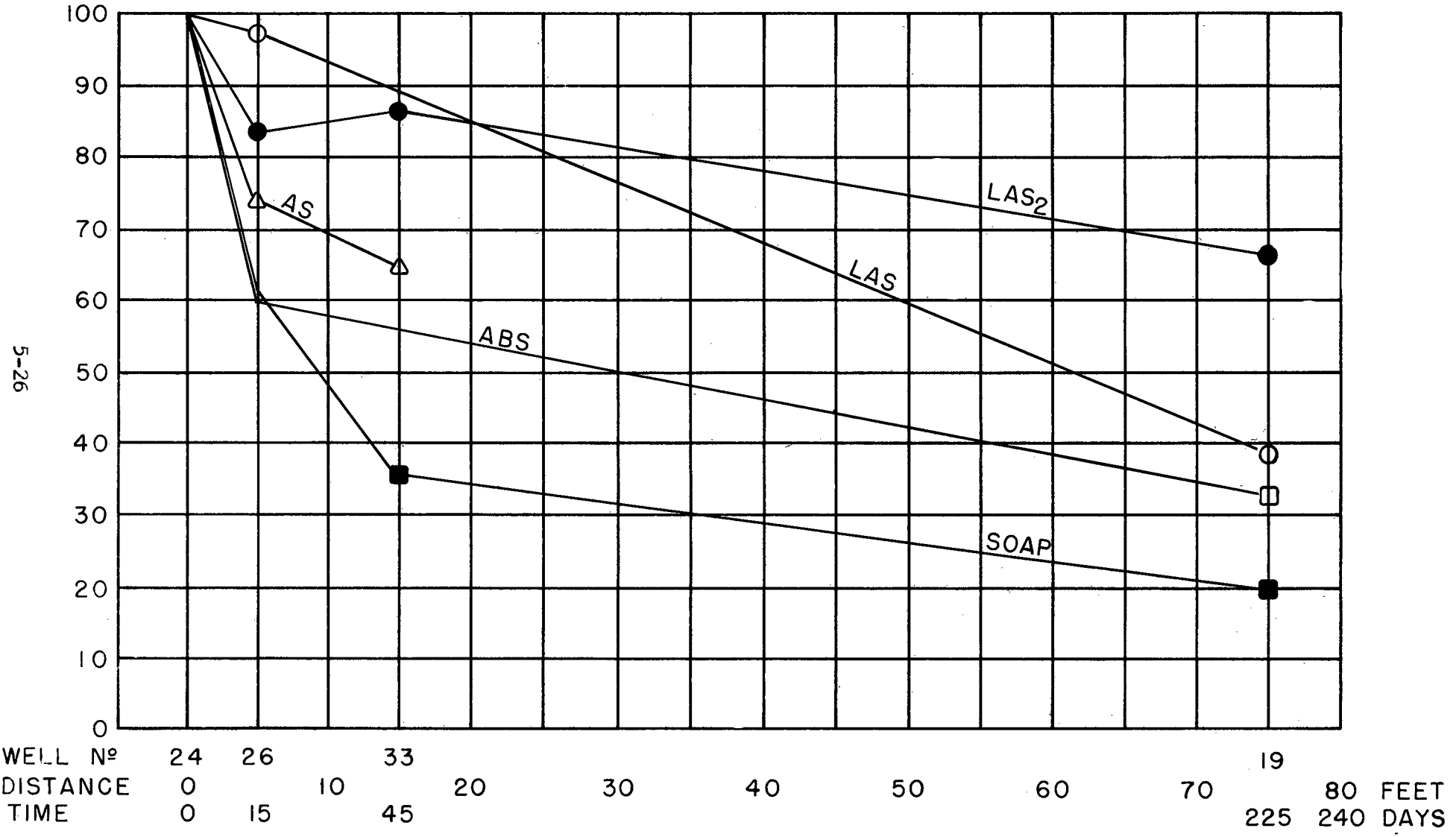

FIG. 5-9

6. Significant amounts of free ammonia still persist at the final observation well group. (Table 5-3, 4 Figure 5-10 through 14)

Nitrite

1. Nitrite concentrations within the disposal system were relatively constant during the use of all surfactants varying between 0.01 and 0.02 mg/l. Background wells exhibited nitrite concentrations of 0.03 and 0.18 mg/l in the background waste slug and surrounding ground waters, respectively. (Table 5-3)
2. Maximum nitrite concentrations during the use of the first three surfactants (ABS, LAS₁ and Soap) developed at well group No. 26, 10 feet downstream from the disposal system, while with the use of the final two surfactants (LAS and AS) peak nitrites occurred at well group No. 24, 5 feet from the cesspool. (Table 5-3, 4 Figure 5-10 through 14, 5-26 through 35)
3. Significant amounts of nitrites developed during the use of the final three surfactants (Soap, LAS₂ and AS) attaining peak levels as high as 1.46 mg/l. Since the amount of ammonia was far in excess of nitrites, complete decomposition of nitrite is assumed.
4. Beyond the well group showing peak nitrite concentrations, nitrites were reduced at the following rates:

		<u>Average Values</u>		
ABS	Well #26-19	1.27%/ft.	0.42%/day	0.003 mg/l/ft.
LAS ₁	26-19	0.70	0.23	0.0006
Soap	33-19	1.27	0.42	0.003
LAS ₂	33-19	1.03	0.34	0.003

Compensating for dilutional effects, based upon chloride reductions, through the downstream flow path resulted in the following net rates of nitrite reductions:

		<u>Average Values</u>	
ABS		0.39%/ft.	0.13%/day
LAS ₁	Dilution Rates Exceed Total Reduction Rates		

LONG ISLAND GROUND WATER POLLUTION STUDY
 NITROGEN CYCLE VERSUS TRAVEL TIME
 ABS IN USE (10/15/1962 - 2/25/1963)
 SITE N° 1 - BROOKHAVEN, SUFFOLK COUNTY, N.Y.

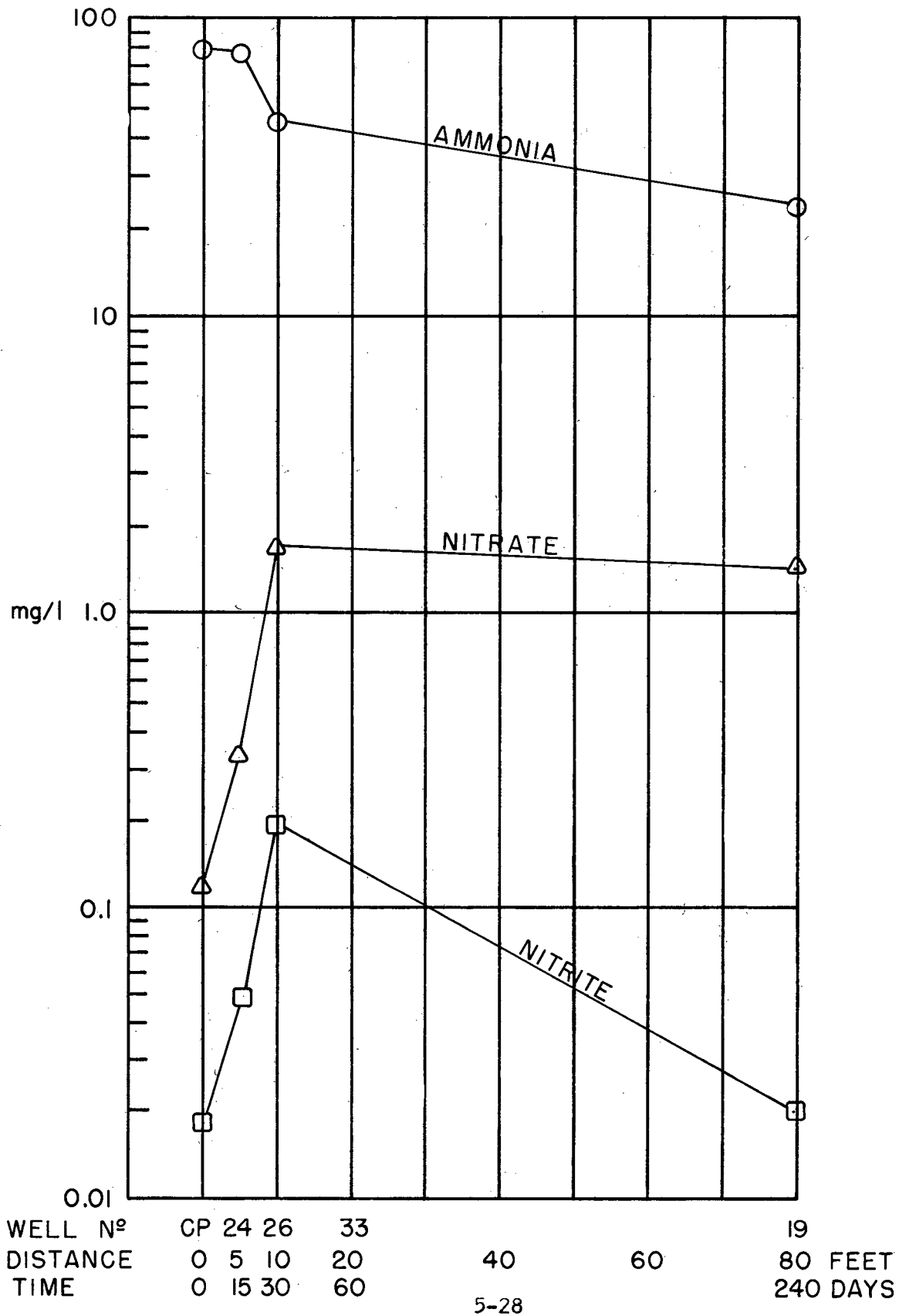

LONG ISLAND GROUND WATER POLLUTION STUDY
 NITROGEN CYCLE VERSUS TRAVEL TIME
 LAS IN USE (2/25/1963-6/12/1963)
 SITE N° 1 - BROOKHAVEN, SUFFOLK COUNTY, N.Y.

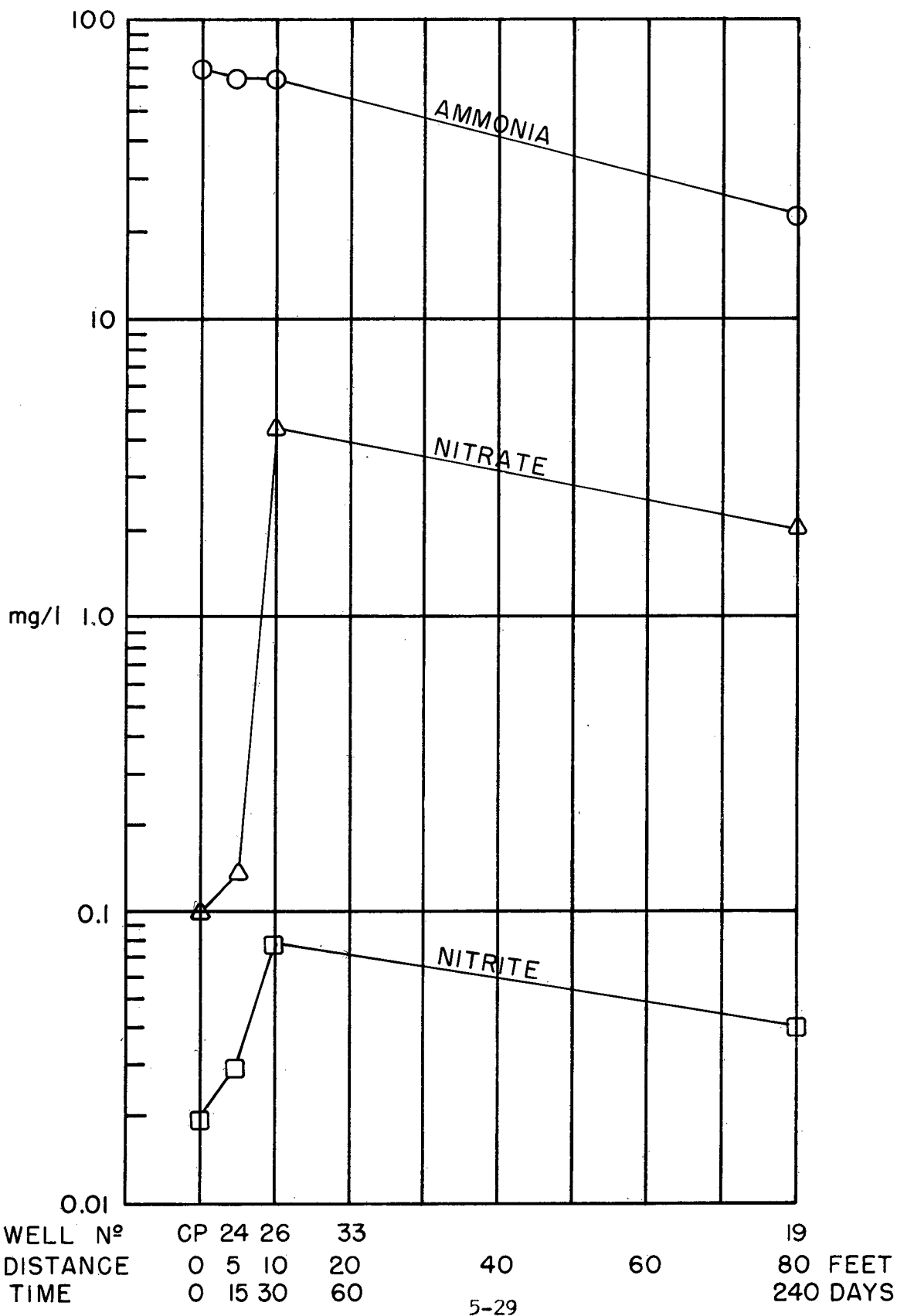

LONG ISLAND GROUND WATER POLLUTION STUDY
 NITROGEN CYCLE VERSUS TRAVEL TIME
 SOAP IN USE (6/12/1963 - 3/1/1964)
 SITE N° 1 - BROOKHAVEN, SUFFOLK COUNTY, N.Y.

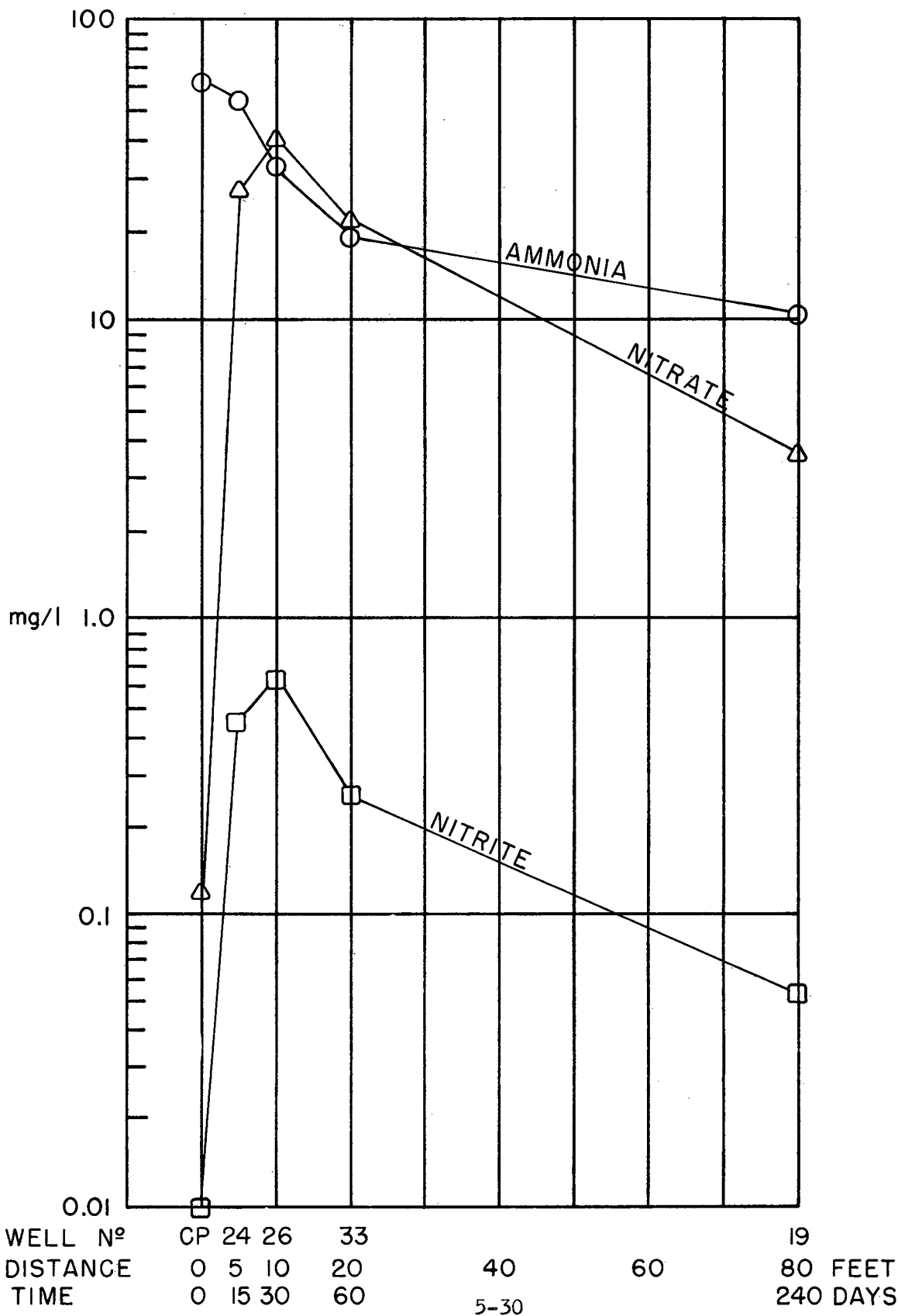

LONG ISLAND GROUND WATER POLLUTION STUDY
 NITROGEN CYCLE VERSUS TRAVEL TIME
 LAS IN USE (3/1/1964-9/2/1964)
 SITE N° 1 - BROOKHAVEN, SUFFOLK COUNTY, N.Y.

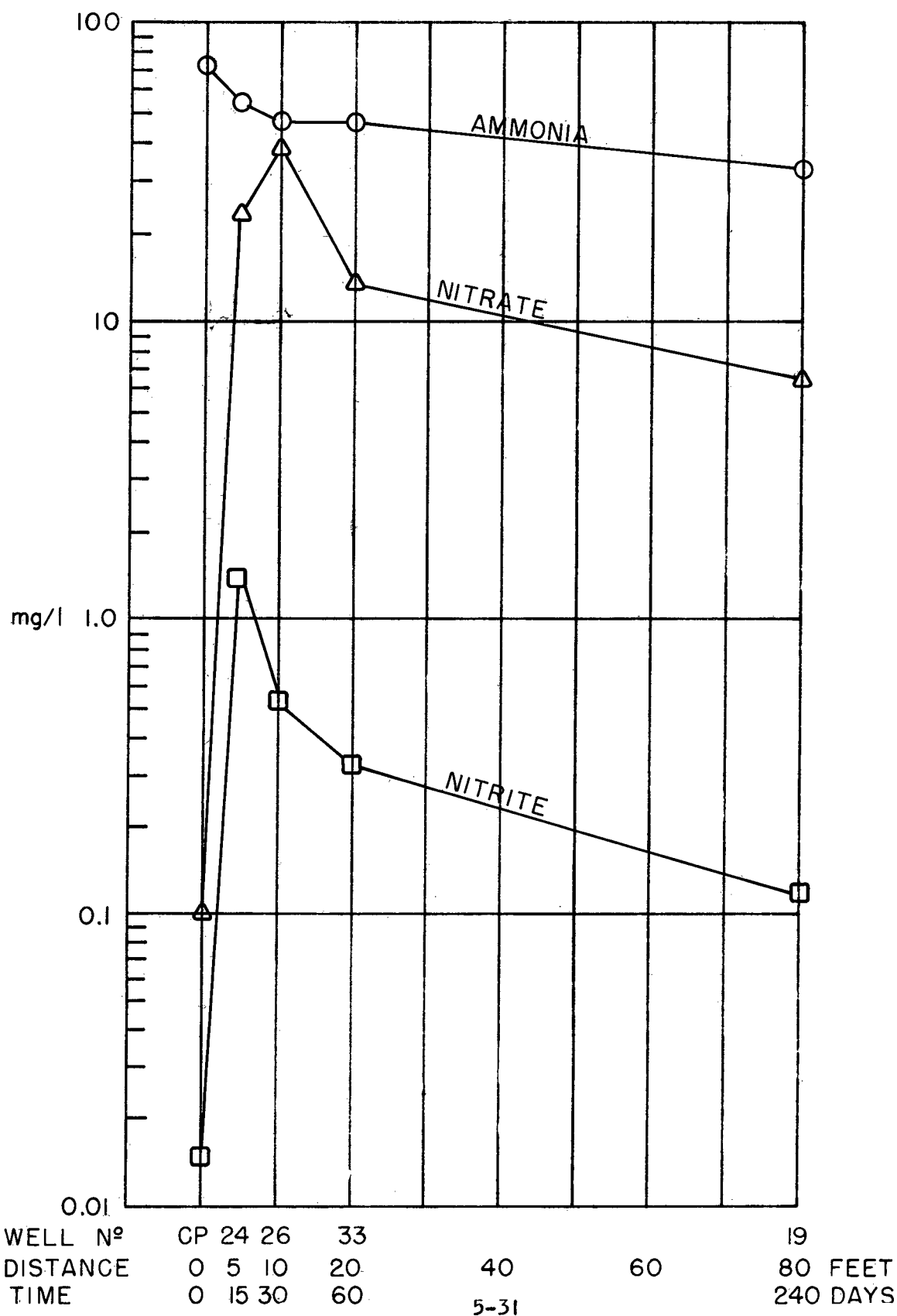

LONG ISLAND GROUND WATER POLLUTION STUDY
 NITROGEN CYCLE VERSUS TRAVEL TIME
 AS IN USE (9/2/1964 -11/30/1964)
 SITE N° 1 - BROOKHAVEN, SUFFOLK COUNTY, N.Y.

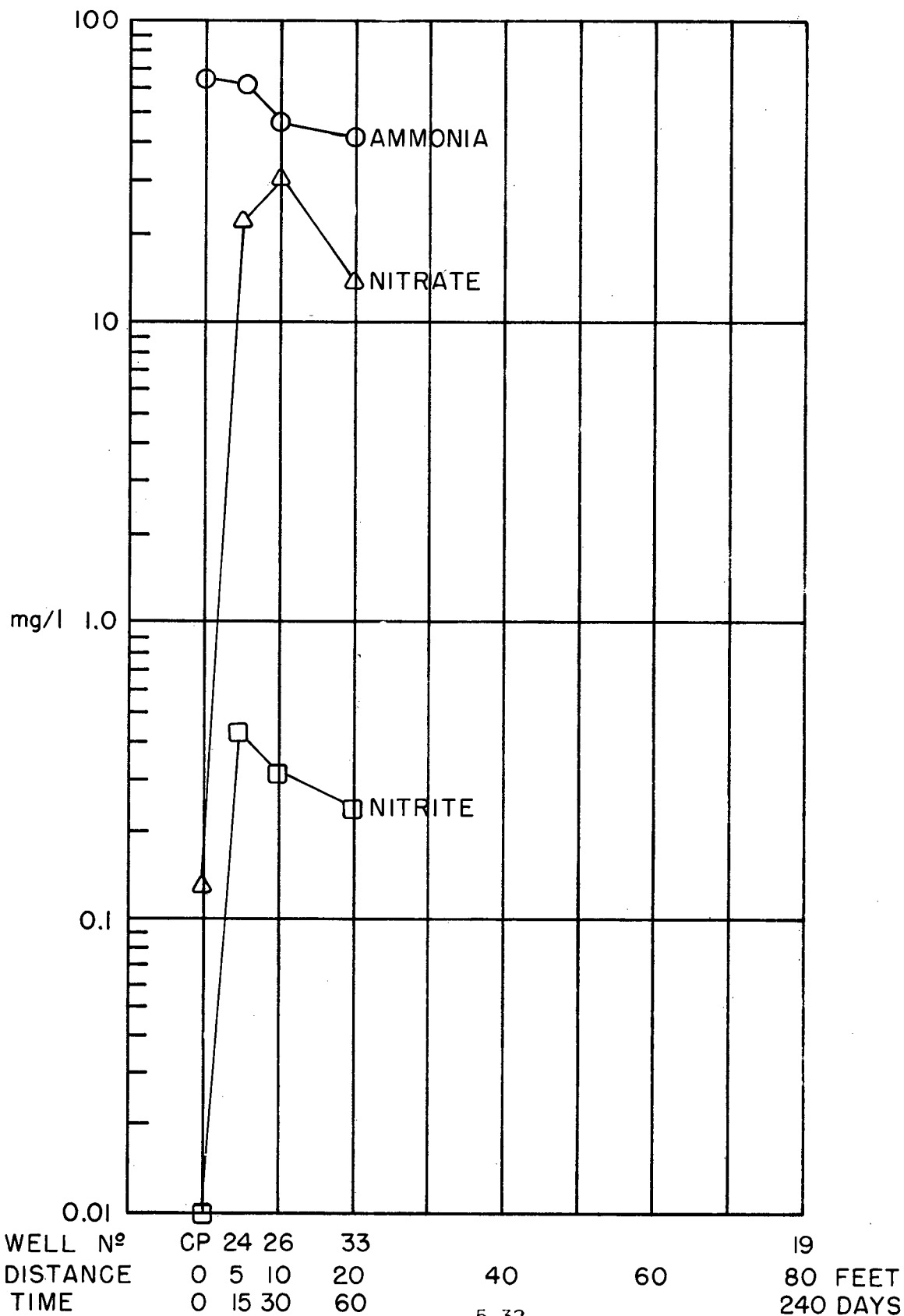

Soap	0.44%/ft.	0.15%/day
LAS ₂	0.33	0.11

5. Generally, factors besides those of dilution result in the reduction in nitrite concentrations through the downstream flow path; i.e., after peak nitrite levels have been achieved.

Nitrates

1. Nitrate concentrations in the disposal system were constant during the use of all surfactants being ≤ 0.01 to 0.14 mg/l. (Table 5-3) Background observation wells indicated average nitrate levels of 0.25 and 5.10 mg/l in the upgradient sewage slug and peripheral ground waters, respectively.

2. During the use of all surfactants nitrification proceeded at about the same rate with maximum nitrate concentrations developing at well group No. 26 or approximately 10 feet downstream from the disposal system.

3. The rapid advancement of the nitrogen cycle was primarily attributed to the dissolved oxygen present.

4. The extent of nitrification varied with the use of the different surfactants used. Fig. 5-10 thru 14, 26 thru 35, Tab. 5-3, 4. Use of the initial two formulations, ABS and LAS₁, resulted in relatively small amounts of nitrate conversion, 1.7 and 4.3 mg/l, at well No. 26. Beginning with the use of Soap, significantly larger nitrate concentrations developed being 40.7, 40.3 and 29.9 mg/l at well No. 26 during the use of Soap, LAS₂ and AS, respectively. Relative amounts of conversion to the inorganic nitrate form was consistent with the production of nitrites.

5. Reductions in nitrate concentration beyond well group No. 26, i.e., after peak nitrate levels were developed proceed at variable rates.

		<u>Average Values</u>		
ABS	Well #26-19	2.48%/ft.	0.82%/day	0.004 mg/l/ft.
LAS ₁	26-19	0.78	0.26	0.03
Soap	33-19	1.39	0.46	0.30
LAS ₂	33-19	0.85	0.28	0.12

Compensating for dilution, based upon reductions in chloride concentrations, resulted in net rates of nitrate reduction through the lower flow path of:

		<u>Average Values</u>	
ABS		1.60%/ft.	0.53%/day
LAS ₁	Dilution Rate Exceeds Total Reduction Rates		
Soap		0.56%/ft.	0.19%/day
LAS ₂		0.08	0.03

It is concluded that factors besides that of ground water dilution come into action in causing the reduction of nitrates in saturated or ground water flow.

Sulfates

1. Sulfate concentrations in the disposal system varied ranging between 7.8 and 40.4 mg/l, except during the use of LAS₁, when an average sulfate level was 126.1/mg/l. (Table 5-3) Background observation wells indicated a uniform sulfate concentration of 19.0 mg/l.
2. In the cesspool, the average sulfate concentration varied with the use of LAS on two separate occasions. The first usage of LAS resulted in average sulfate levels of 126.1 mg/l, while a sulfate content of 29.0 mg/l resulted with the second usage of LAS surfactant.
3. Significant increases in sulfate concentration occurred between the cesspool and first well group except during the use of LAS₁. (Table 5-3, 4 Figure 5-15, 5-26 through 35)
4. Average reductions in sulfate concentrations through the downstream well groups varied as follows:

		<u>Average Values</u>		
ABS	Well #26-19	0.51%/ft.	0.17%/day	0.44 mg/l/ft.
LAS ₁	20-19	0.88	0.29	0.70
Soap	33-19	0.58	0.19	0.49
LAS ₂	33-19	1.00	0.33	1.13

Adjusting for dilution, based upon reductions in chloride concentrations,

LONG ISLAND GROUND WATER POLLUTION STUDY
 REDUCTION VERSUS TRAVEL TIME
 SULFATES (10/15/1962-11/30/1964)
 SITE N° 1 - BROOKHAVEN, SUFFOLK COUNTY, N. Y.

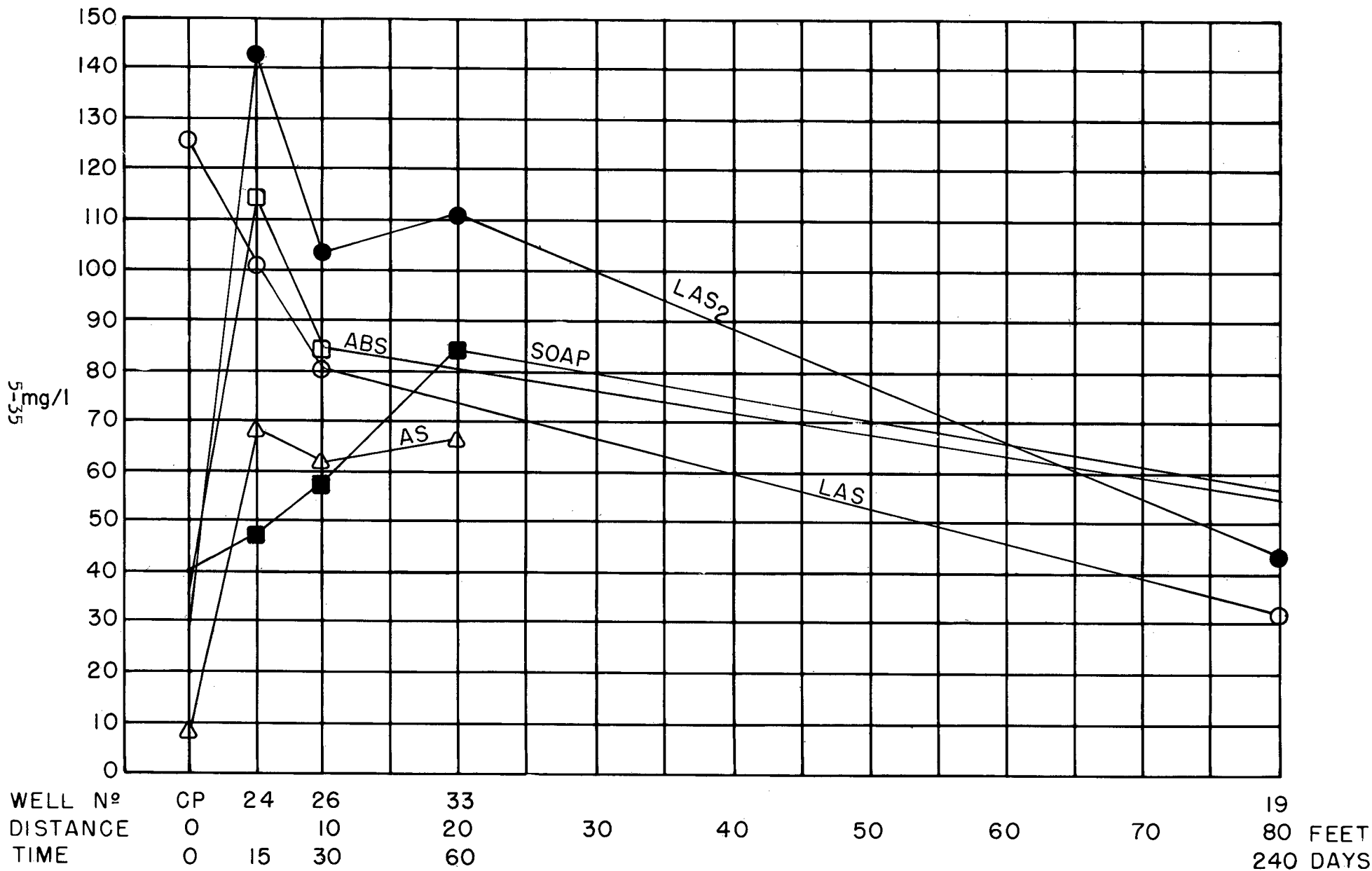

FIG. 5-15

resulted in the following reduction:

ABS	Dilution Rates Exceed Total Reduction Rates		
LAS ₁	0.03%/ft.		0.01%/day
Soap	Dilution Rates Exceed Total Reduction Rates		
LAS ₂	0.30%/ft.		0.10%/day

5. Generally, it appeared that reduction in sulfate content through the downstream saturated soil zone was due primarily to dilutional effects.

6. Significant sulfate levels still persisted at the final observation well group 80' downstream from the disposal system. (Figure 5-15)

Phosphates

1. In most instances, the ortho and total phosphate concentrations in the disposal system and downstream wells were approximately equal. Total phosphate levels in the disposal system ranged between 55.5 and 111.0 mg/l, depending upon the surfactant in use. (Table 5-3) All upstream observation wells measured about the same average total phosphate concentration of 0.10 mg/l.

2. Initial travel in the cesspool region (cesspool to first well group) phosphates decreased in level by 0.9 to 27.6%, except with the use of AS which exhibited a 6.6% increase in concentration.

3. Continued travel in the saturated soil zone resulted in reductions in total phosphate content, generally occurring at a decreasing rate with each succeeding downstream well except during the use of the initial two surfactants, ABS and LAS. (Table 5-3, 4 Figure 5-16, 17, 5-26 through 35)

4. Overall average rates of total phosphate reduction between well group No. 26 and final observation wells were:

	<u>Average Values</u>		
ABS	1.40%/ft.	0.46%/day	2.12 mg/l/ft.
LAS ₁	1.40	0.46	1.75
Soap	1.36	0.45	0.47

LONG ISLAND GROUND WATER POLLUTION STUDY
 REDUCTION VERSUS TRAVEL TIME
 TOTAL PHOSPHATES (10/15/1962-11/30/1964)
 SITE N° 1 - BROOKHAVEN, SUFFOLK COUNTY, N. Y.

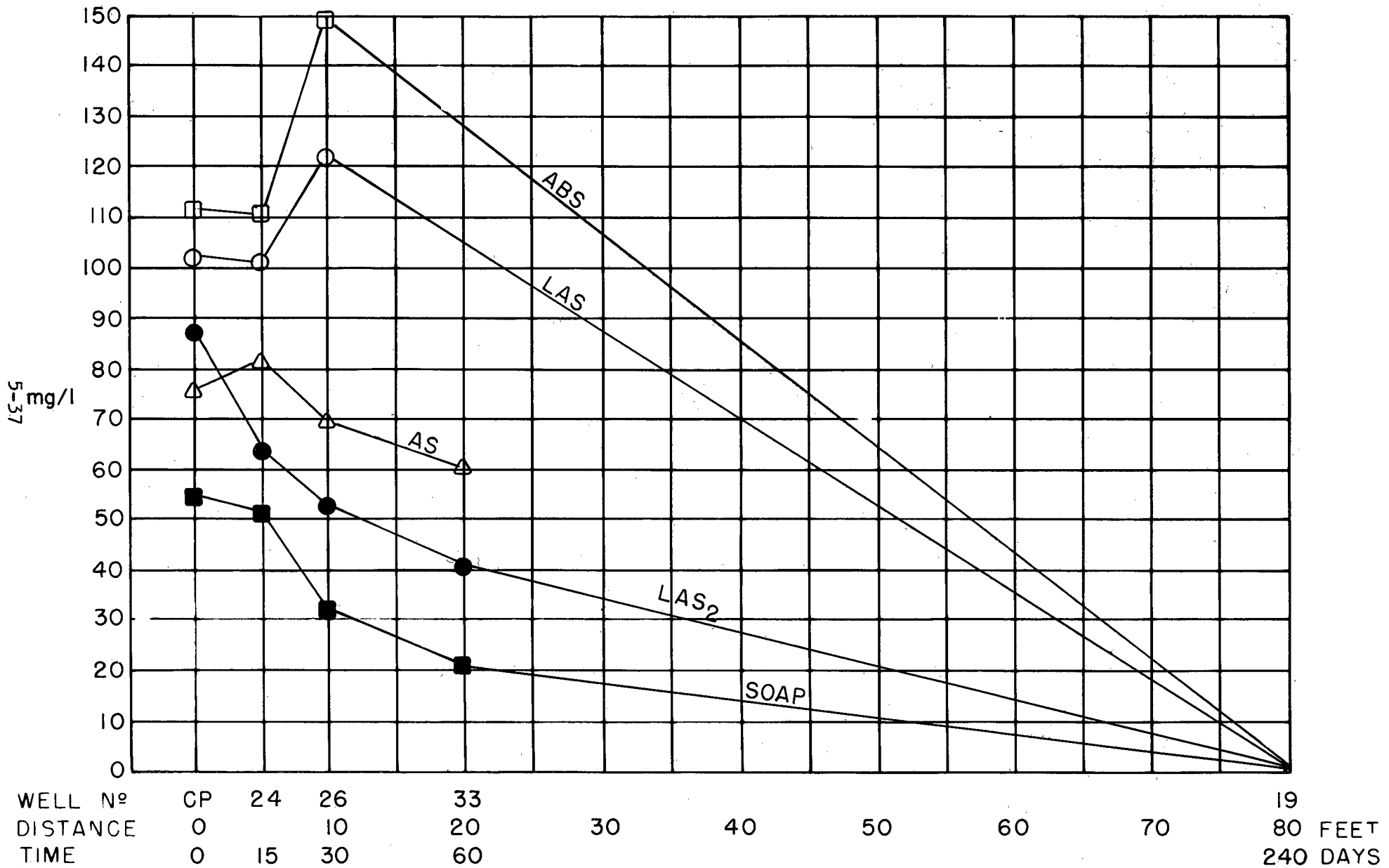
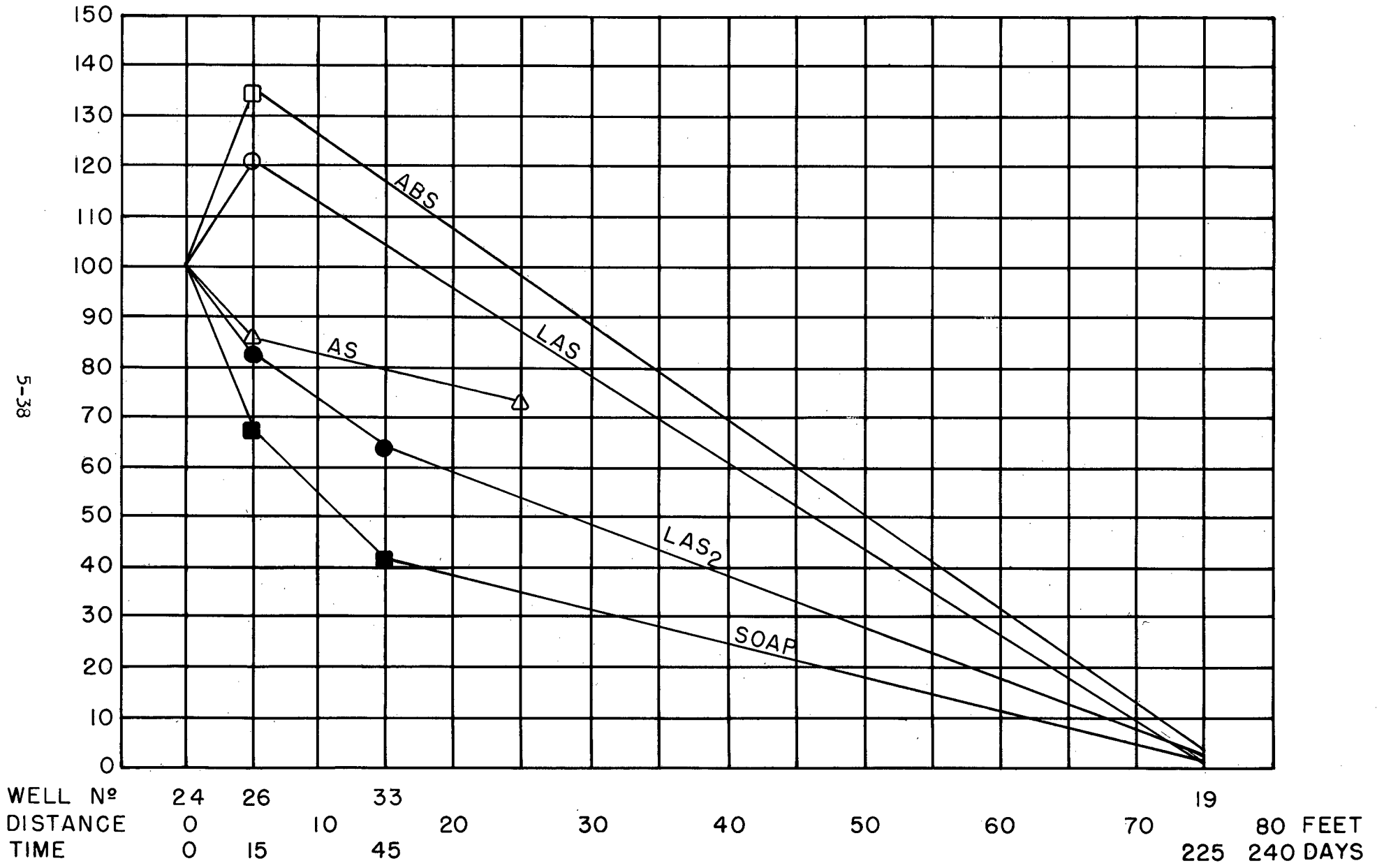

FIG 5-16

LONG ISLAND GROUND WATER POLLUTION STUDY
 PERCENT REMAINING OF FIRST WELL CONCENTRATION
 TOTAL PHOSPHATES (10/15/1962-11/30/1964)
 SITE N° 1 - BROOKHAVEN, SUFFOLK COUNTY, N. Y.



5-38

FIG. 5-17.

LAS ₂	1.40	0.46	0.75
AS	1.33	0.44	0.92

Adjusting for dilution through the saturated zone, based upon chloride reductions, resulted in net total phosphate reduction rates of:

	<u>Average Values</u>	
ABS	0.52%/ft.	0.17%/day
LAS ₁	0.55	0.18
Soap	0.53	0.18
LAS ₂	0.63	0.21
AS	0.63	0.21

5. It was observed, based upon net reduction rates, that factors other than dilution alone resulted in the removal of total and ortho phosphates in travel through the saturated zone. Generally, all living organisms require phosphorus in the inorganic ortho phosphate form. The phosphorus requirement by bacteria and other organisms were not undertaken in these studies.

6. Although extremely large phosphate concentrations were initially present in the cesspool, levels were reduced to between 1.0 and 1.72 mg/l at the final well group. Greater than a 98 percent reduction in total phosphate concentration through the entire flow path resulted during the use of all surfactants.

(Figure 5-17)

Coliform Organisms

1. Log average coliform concentrations (MPN's) within the disposal system varied ranging from a low density of 5.24×10^6 organisms per 100 ml during the use of Soap to maximum densities of 132.8×10^6 with the use of LAS₁. (Table 5-3) Background observation wells indicated log average numbers of 85.0 and less than 2.2 in the upgradient sewage waste slug and peripheral ground waters, respectively.

2. Presence of coliform bacteria in the upgradient waste slug lead to the conclusion that coliform organisms persist for significant time periods and travel distances under ground water conditions. Background wells showing the presence of coliform were also high in other constituents of sewage

LONG ISLAND GROUND WATER POLLUTION STUDY
 REDUCTION VERSUS TRAVEL TIME
 LOG AVERAGE COLIFORM (10/15/1962-11/30/1964)
 SITE N° 1 - BROOKHAVEN, SUFFOLK COUNTY, N.Y.

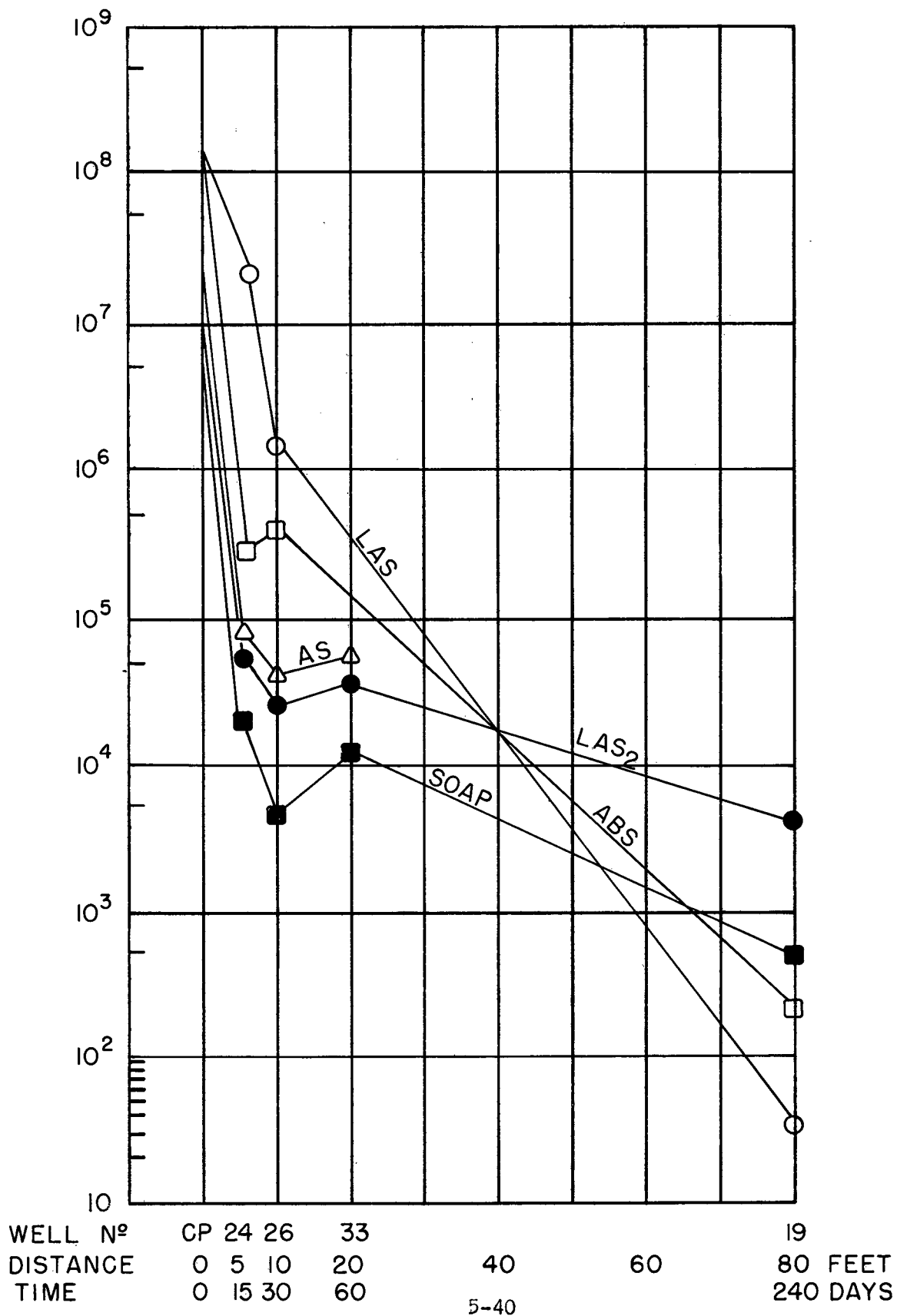

LONG ISLAND GROUND WATER POLLUTION STUDY
 PERCENT REMAINING OF FIRST WELL CONCENTRATION
 LOG AVERAGE COLIFORM (10/15/1962 -11/30/1964)
 SITE N° 1 - BROOKHAVEN, SUFFOLK COUNTY, N. Y.

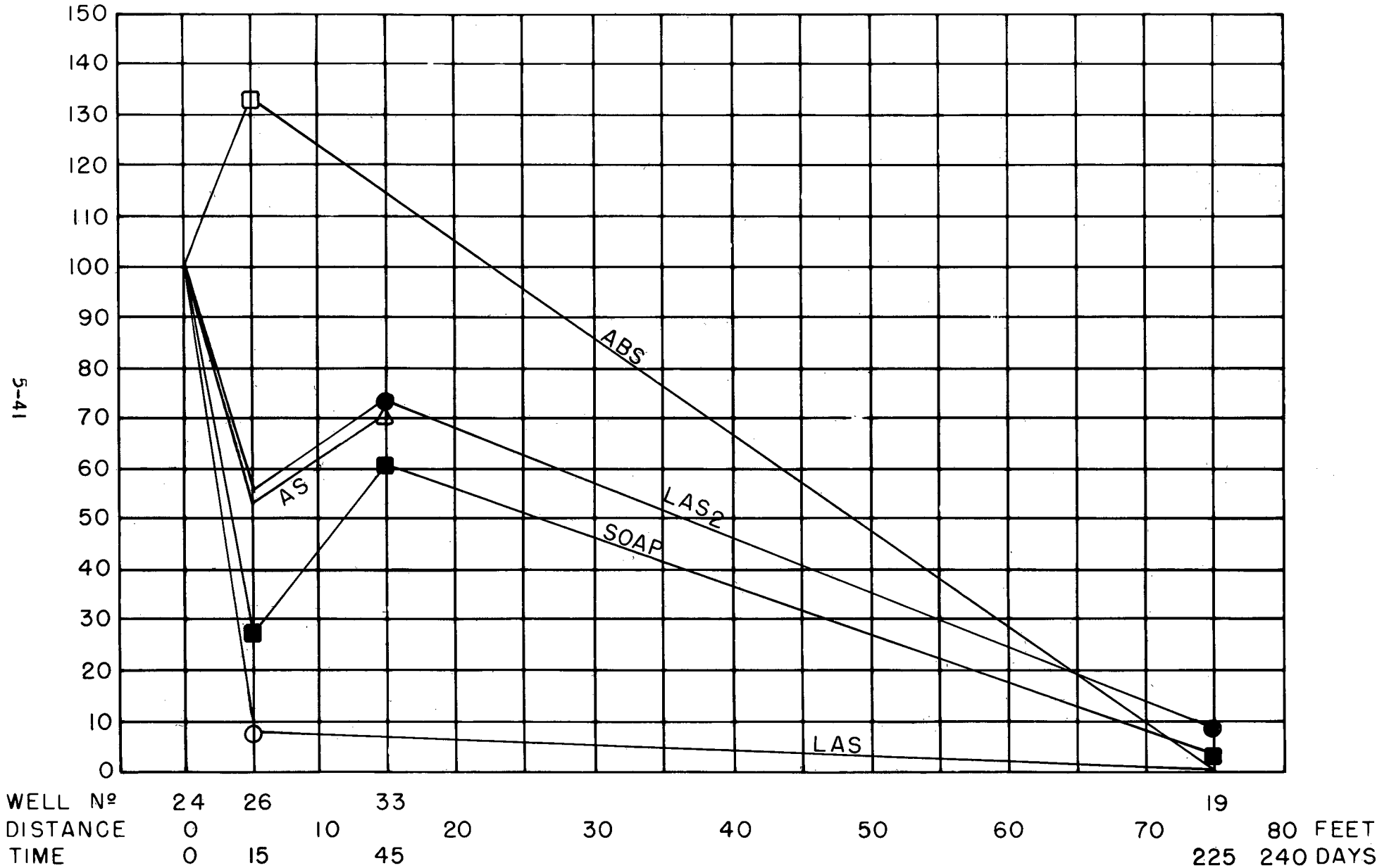

FIG. 5-19

origin. The upstream wells on Site No. 1 were located more than 500 feet down-gradient from any other sewage disposal systems.

3. Significant reductions in log average coliform concentrations greater than 99.5 percent resulted in travel of the waste slug between the cesspool and first well group, except during LAS₇ usage. Through this initial flow path, only an 84 percent reduction of coliform organism occurred. (Figure 5-19, Table 5-3, 4)

4. Movement of the sewage slug in the saturated soil zone first to last well group, resulted in a 91 to 99 percent reduction of the first well No. 24 coliform density. (Figure 5-27, 29, 31, 33, 35)

5. Downstream sampling wells not intercepting the waste slug were predominantly free of coliform organisms and measured little or no contamination by other constituents of sewage origin.

6. Overall coliform die-away and phosphate reductions at the final observation well group achieved about the same order of magnitude--greater than 98 percent. Increased reduction rates during the use of ABS and LAS surfactants were common to coliform organisms, MBAS and total phosphates.

7. A direct association between the die-off or reduction of coliform organisms and decreases in MBAS, phosphates or other sewage constituents was not apparent.

8. Although the total reduction in log average coliform populations appeared to be significant, densities exceeding allowable bacterial concentrations for a potable water still existed at the final observation well group 80 feet downstream from the disposal system. Log average coliform MPN's at the last well group ranged between 13.7 and 4724 organisms per 100 ml. (Figure 5-18, 19)

Alkalinity

1. Alkalinity in the disposal system varied with each surfactant averaging between 359 and 470 mg/l as CaCO₃. (Table 5-3) Upstream observation wells had average alkalinity concentrations of 30.0 and 16.0 mg/l as CaCO₃ in the background slug and peripheral ground waters, respectively.

2. Alkalinity concentrations in the downstream saturated zone tended to

decrease at a relatively uniform rate, except during the use of the AS surfactant. (Figure 5-20, 21, 5-26 through 35 Table 5-3, 4) Rates of alkalinity reduction in this downstream flow path were:

	<u>Average Values</u>		
ABS	1.0%/ft.	0.33%/day	4.35 mg/l/ft.
LAS ₁	0.67	0.22	2.35
Soap	0.70	0.23	3.26
LAS ₂	0.64	0.21	1.93

Adjusting for dilution, based upon reductions in chloride concentrations, resulted in net alkalinity reduction rates of:

	<u>Average Values</u>	
ABS	0.12%/ft.	0.04%/day
LAS ₁	Dilution Rates Exceeds Total Reduction Rates	
Soap	Dilution Rates Exceeds Total Reduction Rates	
LAS ₂	Dilution Rates Exceeds Total Reduction Rates	

3. Based upon net alkalinity reduction rates, decreases in alkalinity concentrations were due wholly to dilutional effects (dilution based upon reductions in chloride concentrations.)

4. Generally, those wells showing the presence of the sewage slug in the background and downstream wells were higher in alkalinity content than wells not indicating sewage constituents. (Figure 5-20, 21)

Specific Conductance

1. Specific conductivity in the disposal system ranged between 655 and 845 umhos/cm². (Table 5-3) Background observation wells indicated average specific conductance of 115 and 85 umhos/cm² measured in those wells showing presence of sewage contaminants and peripheral ground waters, respectively.

2. Within the disposal system, average specific conductivity values increased with the use of each succeeding surfactant.

3. Generally, reductions in specific conductance occurred through the down-

LONG ISLAND GROUND WATER POLLUTION STUDY
 REDUCTION VERSUS TRAVEL TIME
 ALKALINITY (10/15/1962 - 11/30/1964)
 SITE N° 1- BROOKHAVEN, SUFFOLK COUNTY, N. Y.

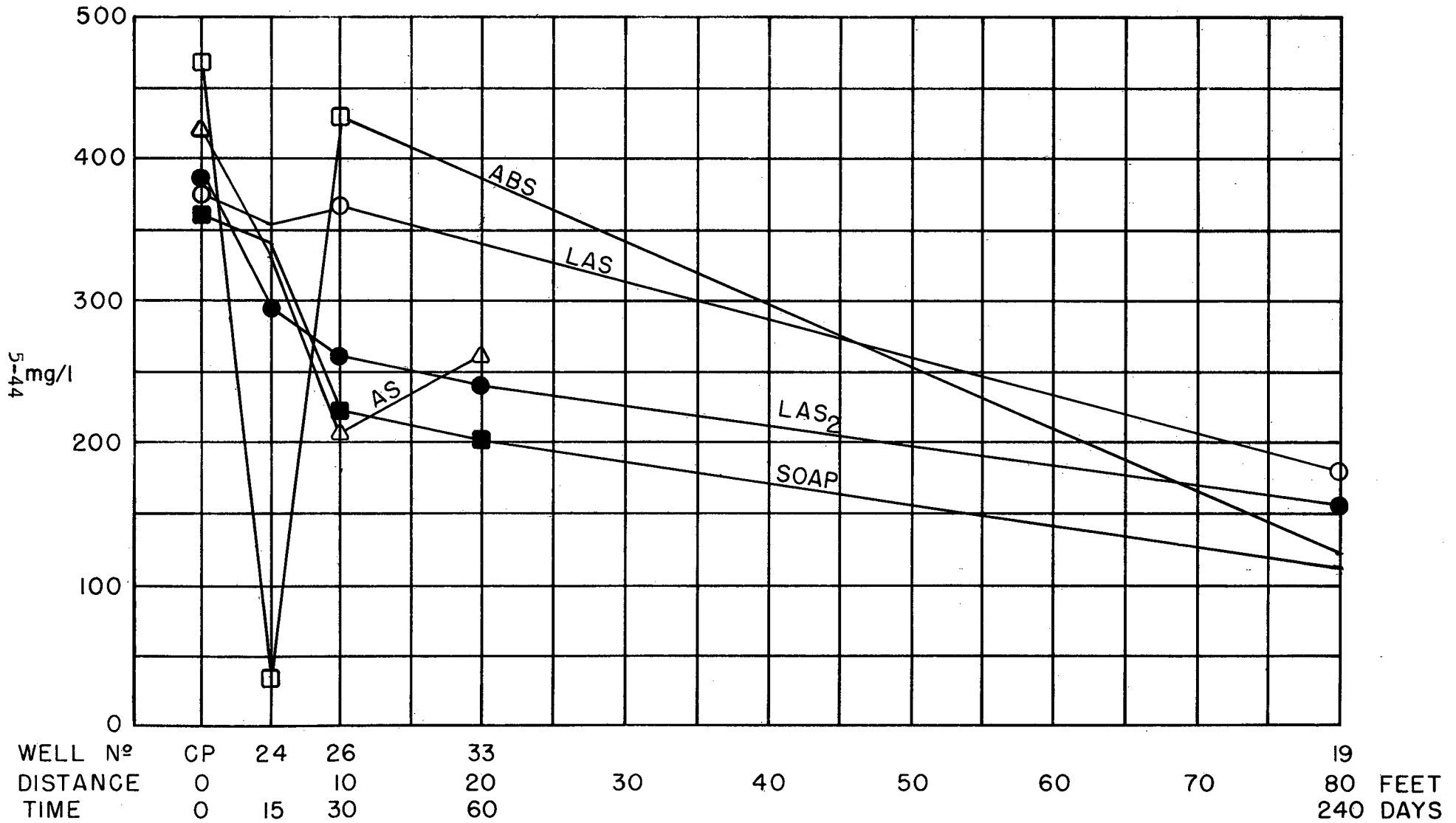

FIG. 5-20

LONG ISLAND GROUND WATER POLLUTION STUDY
 PERCENT REMAINING OF FIRST WELL CONCENTRATION
 ALKALINITY (2/25/1963 - 11/30/1964)
 SITE N° 1 - BROOKHAVEN, SUFFOLK COUNTY, N. Y.

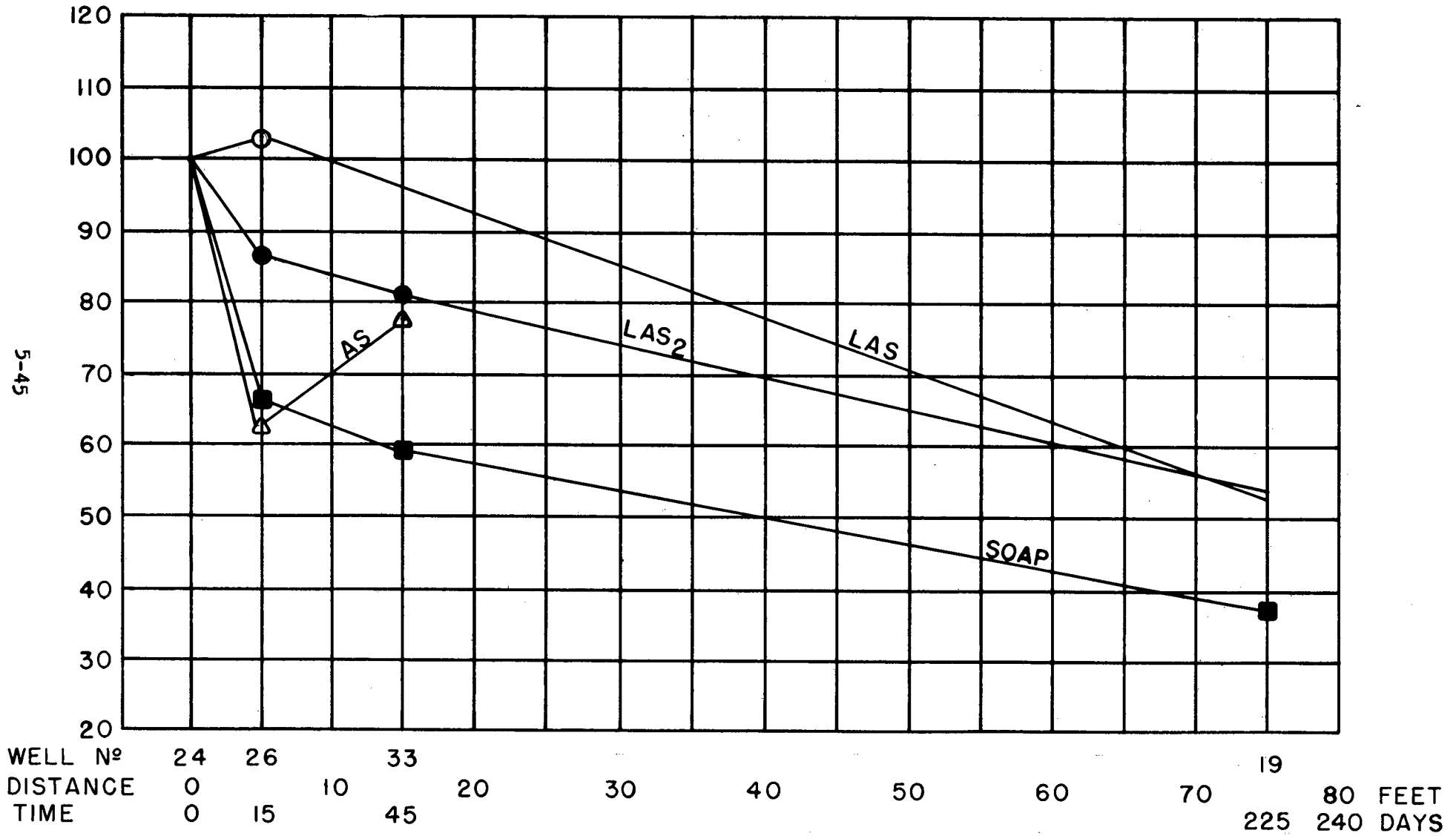

FIG. 5-21

stream flow path at a decreasing rate with each subsequent downstream well group. Overall levels of other sewage constituents also tended to decrease through the same downstream travel distance. (Figure 5-22, 23, 5-26 through 35, Table 5-3, 4)

4. Specific conductance decreased through the downstream saturated soil zone, first to last well groups, at the following average rates:

<u>Average Values</u>			
LAS ₁	0.39%/ft.	0.13%/day	2.5 umhos/cm ² /day
Soap	0.82	0.27	5.25
LAS ₂	0.50	0.17	3.43
AS	2.18	0.72	9.75

5. Reductions in specific conductance proceeded (except during the use of AS surfactant), at a smaller rate than that of chlorides which was considered as the indicator of ground water dilution.

COD

1. Chemical oxygen demand, COD, in the disposal system varied with the use of each surfactant ranging between 153 and 309 mg/l. (Table 5-3) All background wells measured approximately the same average COD concentration (12.5 mg/l).

2. Travel of the waste between the cesspool and first downstream well group resulted in significant COD reductions occurring at the following rates:

<u>Average Values</u>			
ABS	33.3%	6.65%/ft.	20.6 mg/l/ft.
LAS ₁	41.6	8.35	23.4
Soap	14.5	2.90	4.2

3. In the downstream saturated soil zone, COD levels tended to increase between wells No. 24 and 26 followed by reductions in concentration out to the final well group during the use of ABS and LAS₁. (Figure 5-24, 25, 5-26 thru 35, Table 5-3, 4) With Soap usage, COD reduced at a decreasing rate at each subsequent downstream well group. Average COD reduction rates in the saturated soil zone were:

LONG ISLAND GROUND WATER POLLUTION STUDY
 REDUCTION VERSUS TRAVEL TIME
 SPECIFIC CONDUCTANCE (2/25/1963-11/30/1964)
 SITE N° 1- BROOKHAVEN, SUFFOLK COUNTY, N. Y.

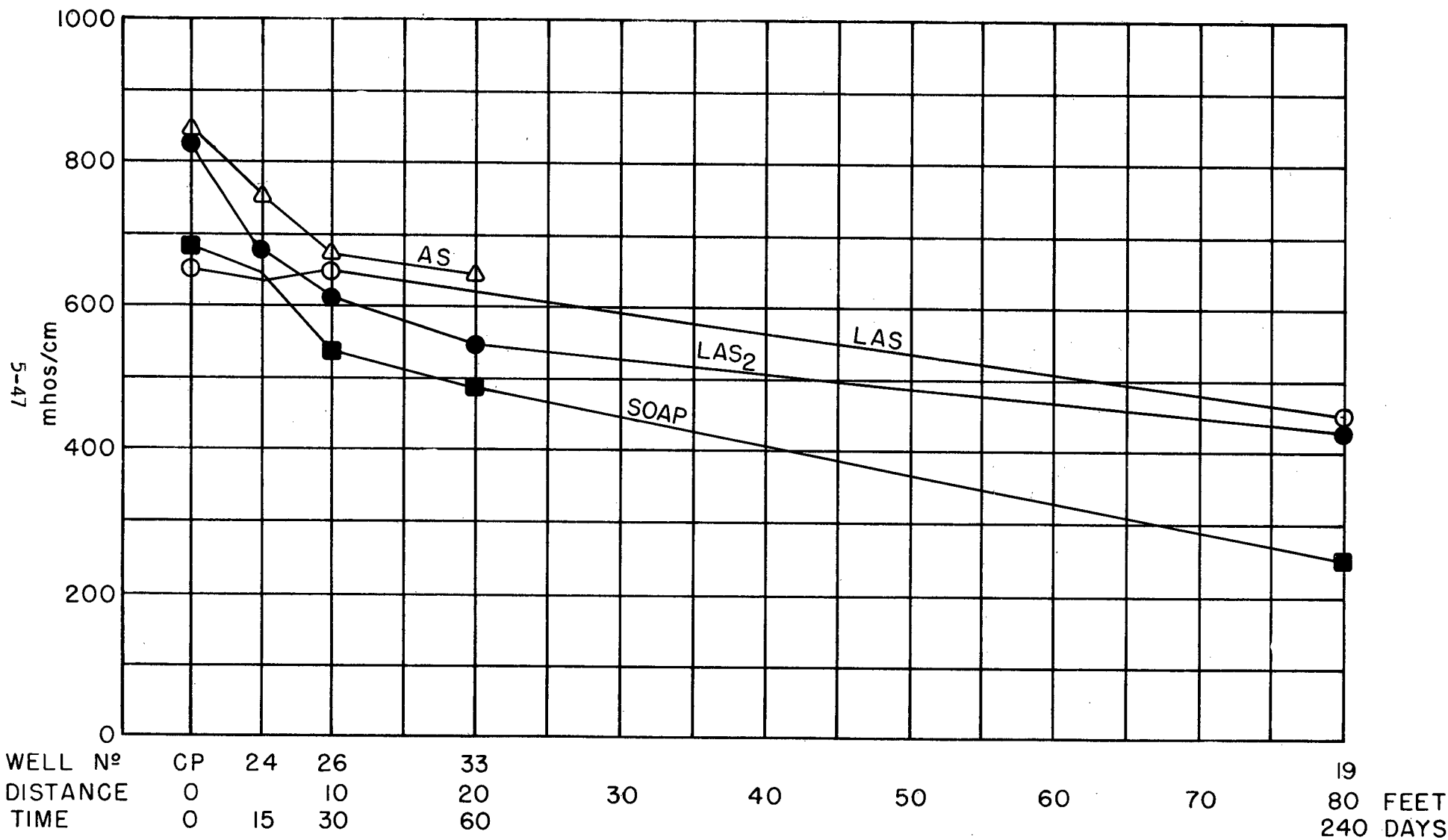
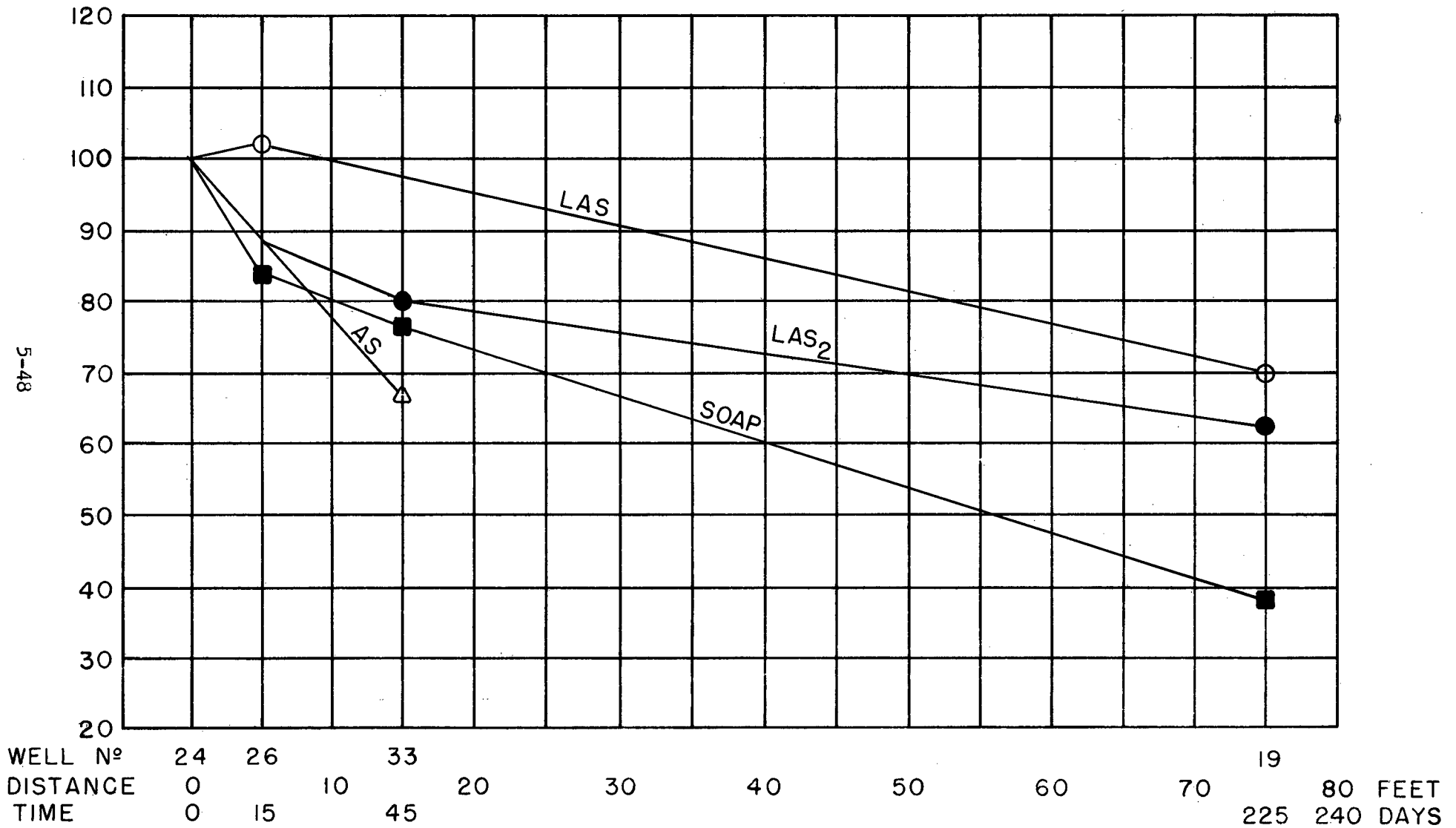

FIG. 5-22

LONG ISLAND GROUND WATER POLLUTION STUDY
 PERCENT REMAINING OF FIRST WELL CONCENTRATION
 SPECIFIC CONDUCTANCE (2/25/1963-II/30/1964)
 SITE N° 1 - BROOKHAVEN, SUFFOLK COUNTY, N. Y.



5-48

FIG. 5-23

LONG ISLAND GROUND WATER POLLUTION STUDY
 REDUCTION VERSUS TRAVEL TIME
 COD (10/15/1962 - 3/1/1964)
 SITE N° 1- BROOKHAVEN, SUFFOLK COUNTY, N. Y.

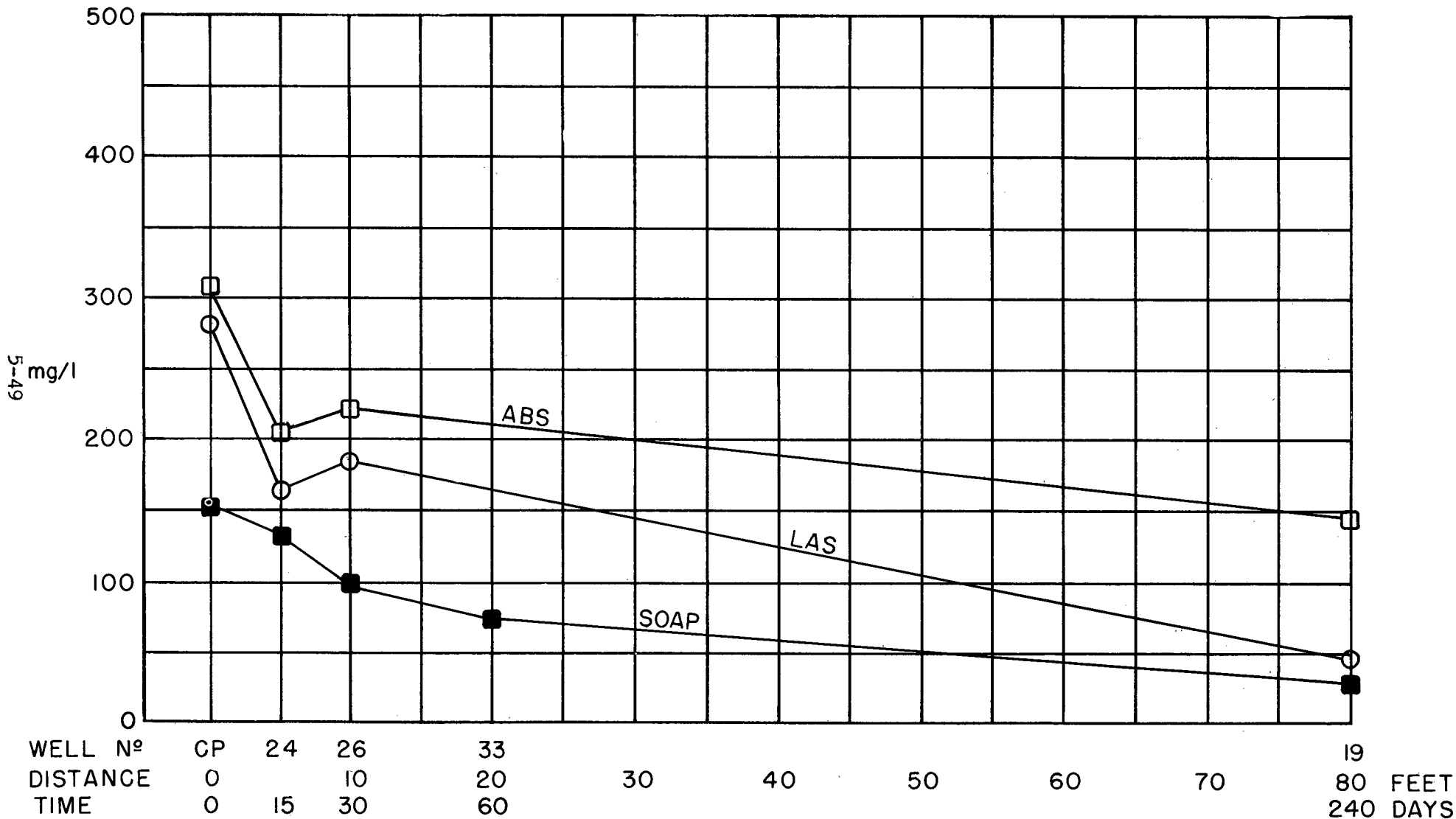

FIG. 5-24

LONG ISLAND GROUND WATER POLLUTION STUDY
 PERCENT REMAINING OF FIRST WELL CONCENTRATION
 COD (10/15/1962-3/1/1964)
 SITE N° 1 - BROOKHAVEN, SUFFOLK COUNTY, N. Y.

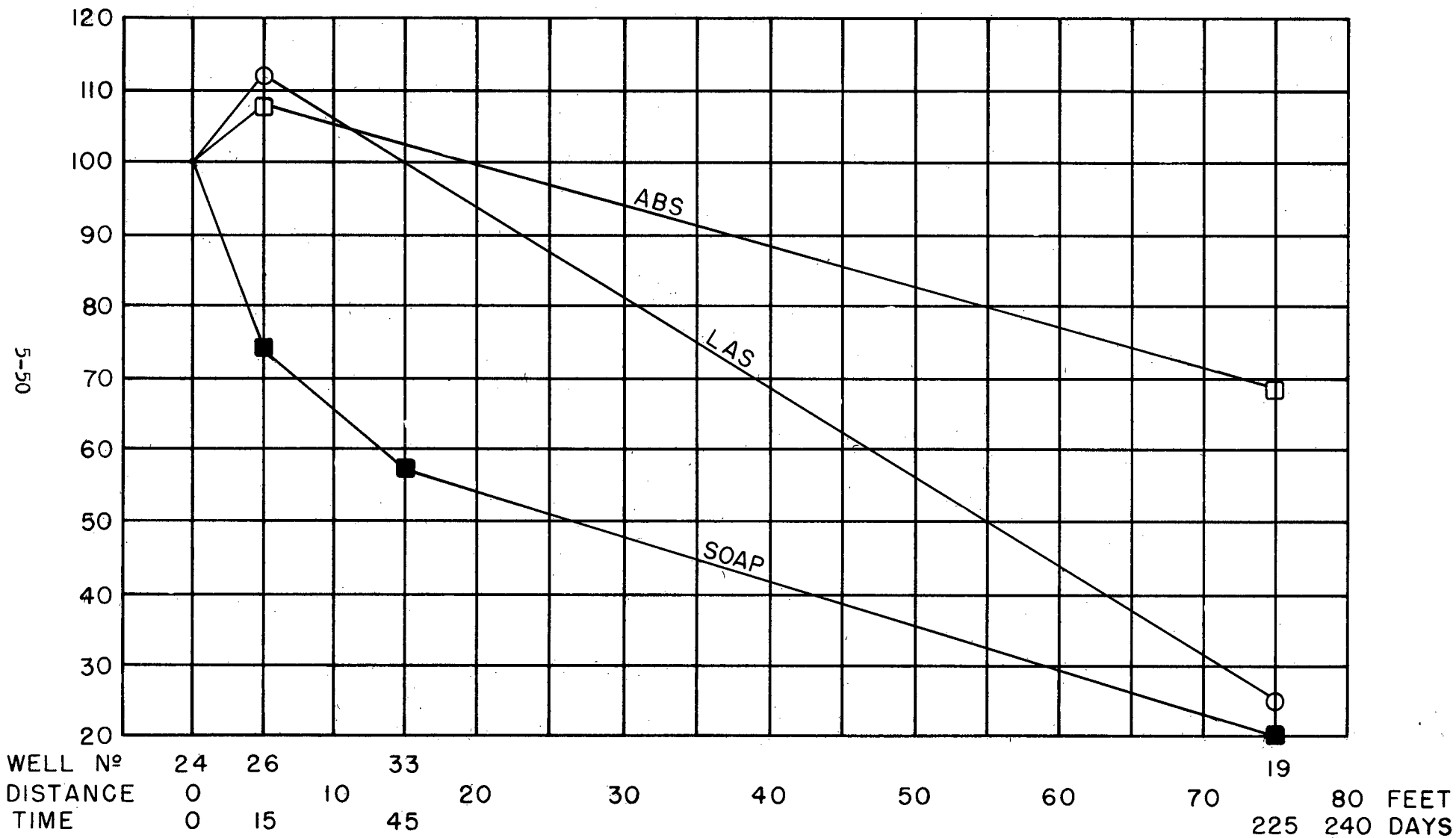

FIG. 5-25

Average Values

ABS	Well #26 to #19	0.51%/ft.	0.17%/day	1.14 mg/l/ft.
LAS ₁	#26 to #19	1.11	0.37	2.1
Soap	#24 to #19	1.06	0.35	1.39

Compensating for dilutional effects, based upon reductions in chloride concentrations, resulted in net COD reduction rates of:

ABS	Dilution Rates Exceeds Total Reduction Rates		
LAS ₁	0.26%/ft.		0.09%/day
Soap	0.23		0.08

4. Based upon COD reduction rates, it can be concluded that organic matter is being removed from the waste at a more rapid rate in the cesspool-soil region.

5. Generally, factors besides that of dilution alone were effective in removing organic matter through the saturated zone and thus reducing COD levels.

BOD

1. Biochemical oxygen demand, BOD, in the disposal system varied with the surfactant in use and ranged between 250 and 550 mg/l. The largest BOD occurred during the use of the Soap product.

2. Ratios of BOD/COD indicated that there was laboratory error in either of the determinations. Generally, a BOD/COD ratio of domestic waste should not exceed 1.0. BOD and COD levels indicated the following ratios:

	<u>BOD</u>	<u>COD</u>	<u>BOD/COD</u>
ABS	---	309 mg/l	----
LAS ₁	360 mg/l	281	1.28
Soap	550	153	3.60
LAS ₂	295	---	----
AS	250	---	---

3. There was no consistent relationship between the BOD and suspended solids in the cesspool. Generally, BOD values were greater than that of suspended solids.

Total and Suspended Solids

1. Total and suspended solids in the disposal system remained relatively consistent with the use of various surfactants.
2. Generally, the largest total solid concentration occurred during the use of Soap, the washing product which also had the largest BOD level in the cesspool.

	<u>Total Solids</u>	<u>Suspended Solids</u>	<u>BOD</u>
ABS	---	---	---
LAS ₁	770 mg/l	---	360 mg/l
Soap	828	200 mg/l	550
LAS ₂	725	260	295
AS	760	186	250

LONG ISLAND GROUND WATER POLLUTION STUDY
 REDUCTION VERSUS TRAVEL TIME
 ABS IN USE (10/15/1962-2/25/1963)
 SITE N° 1 - BROOKHAVEN, SUFFOLK COUNTY, N. Y.

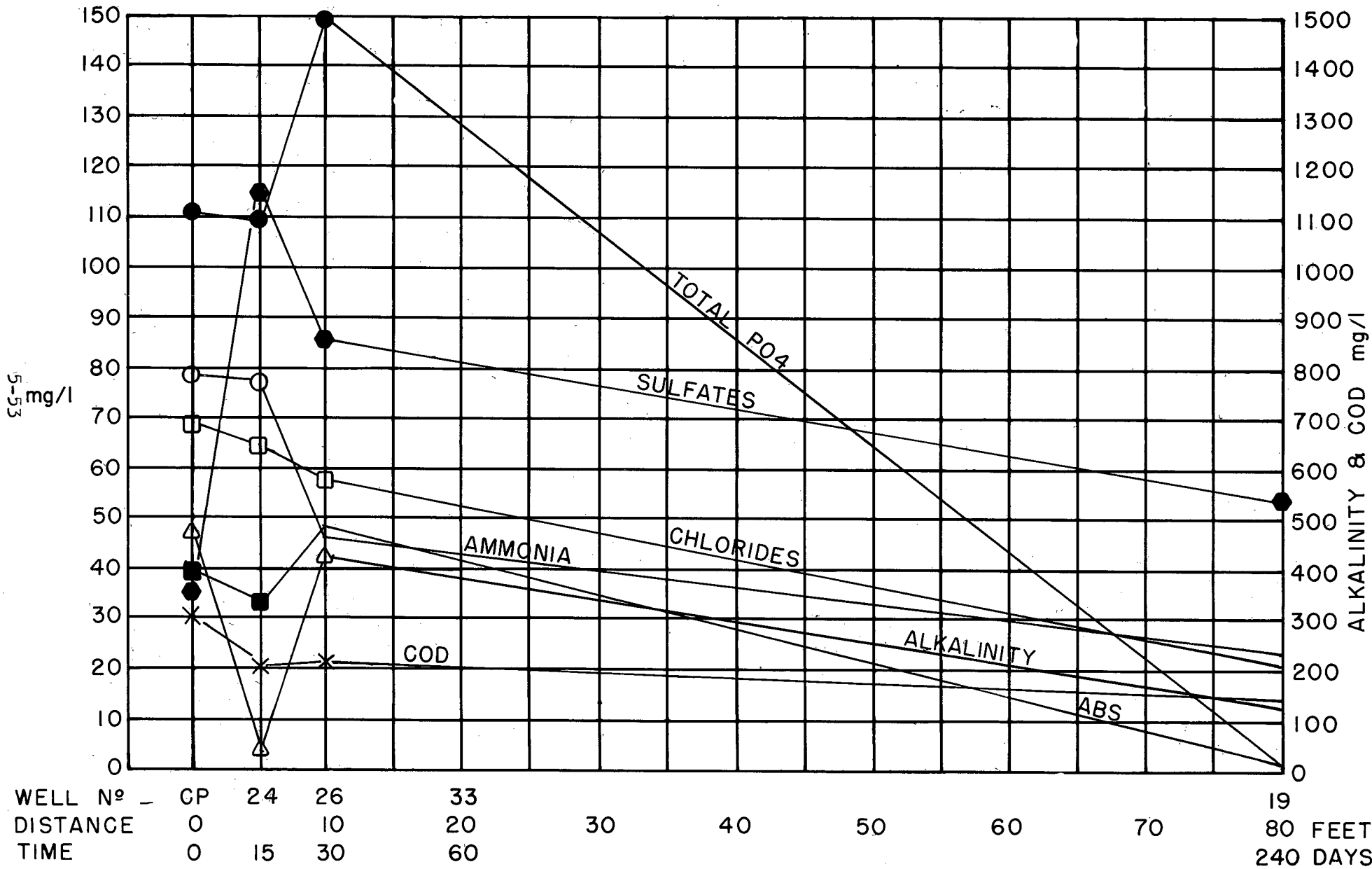

FIG. 5-26

LONG ISLAND GROUND WATER POLLUTION STUDY
 PERCENT REMAINING OF FIRST WELL CONCENTRATION
 ABS IN USE (10/15/1962-2/25/1963)
 SITE N° 1 - BROOKHAVEN, SUFFOLK COUNTY, N. Y.

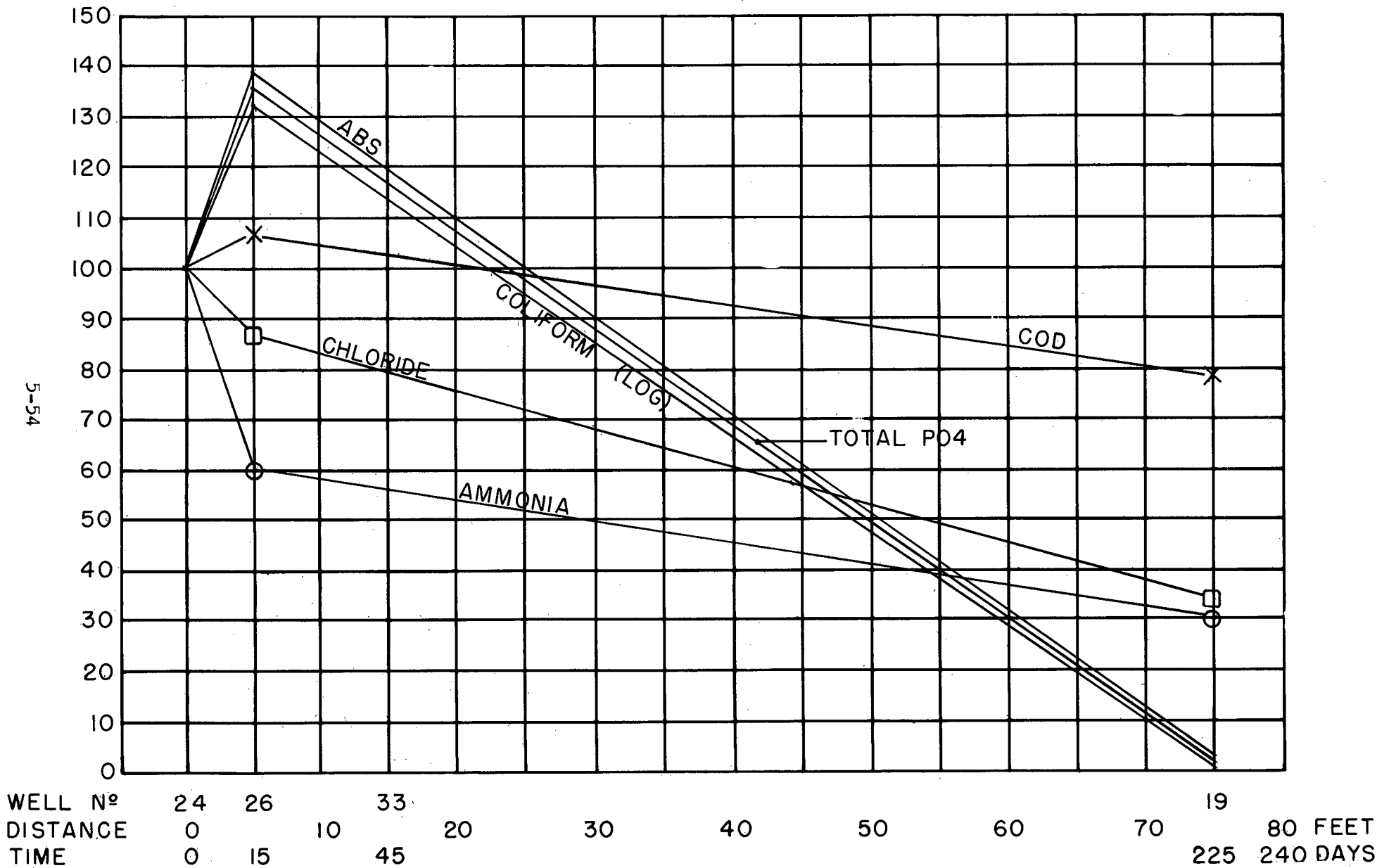

FIG. 5-27

LONG ISLAND GROUND WATER POLLUTION STUDY
 REDUCTION VERSUS TRAVEL TIME
 LAS IN USE (2/25/1963-6/12/1963)
 SITE N° 1 - BROOKHAVEN, SUFFOLK COUNTY, N. Y.

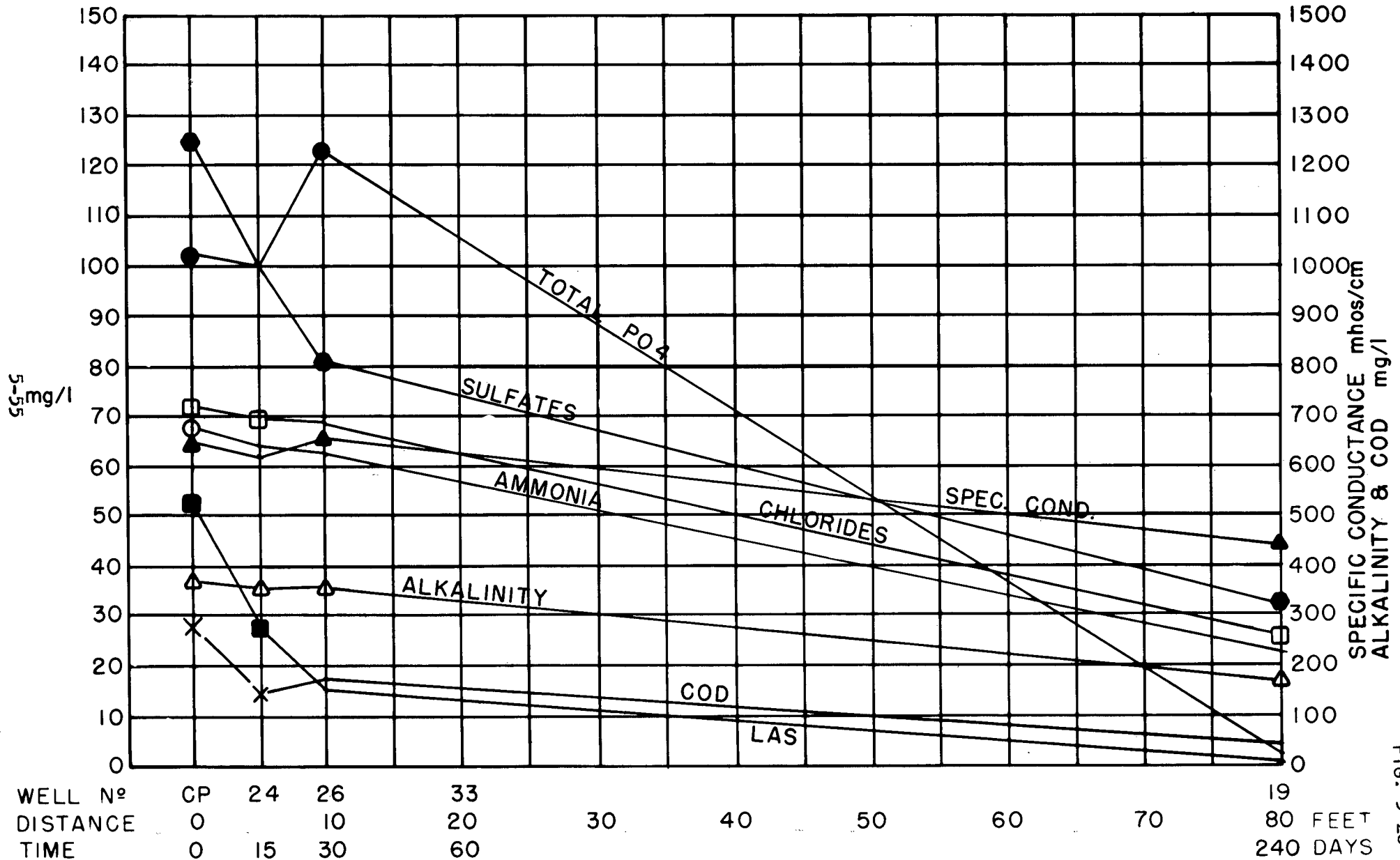

FIG. 5-28

LONG ISLAND GROUND WATER POLLUTION STUDY
 PERCENT REMAINING OF FIRST WELL CONCENTRATION
 LAS IN USE (2/25/1963-6/12/1963)
 SITE N° 1 - BROOKHAVEN, SUFFOLK COUNTY, N. Y.

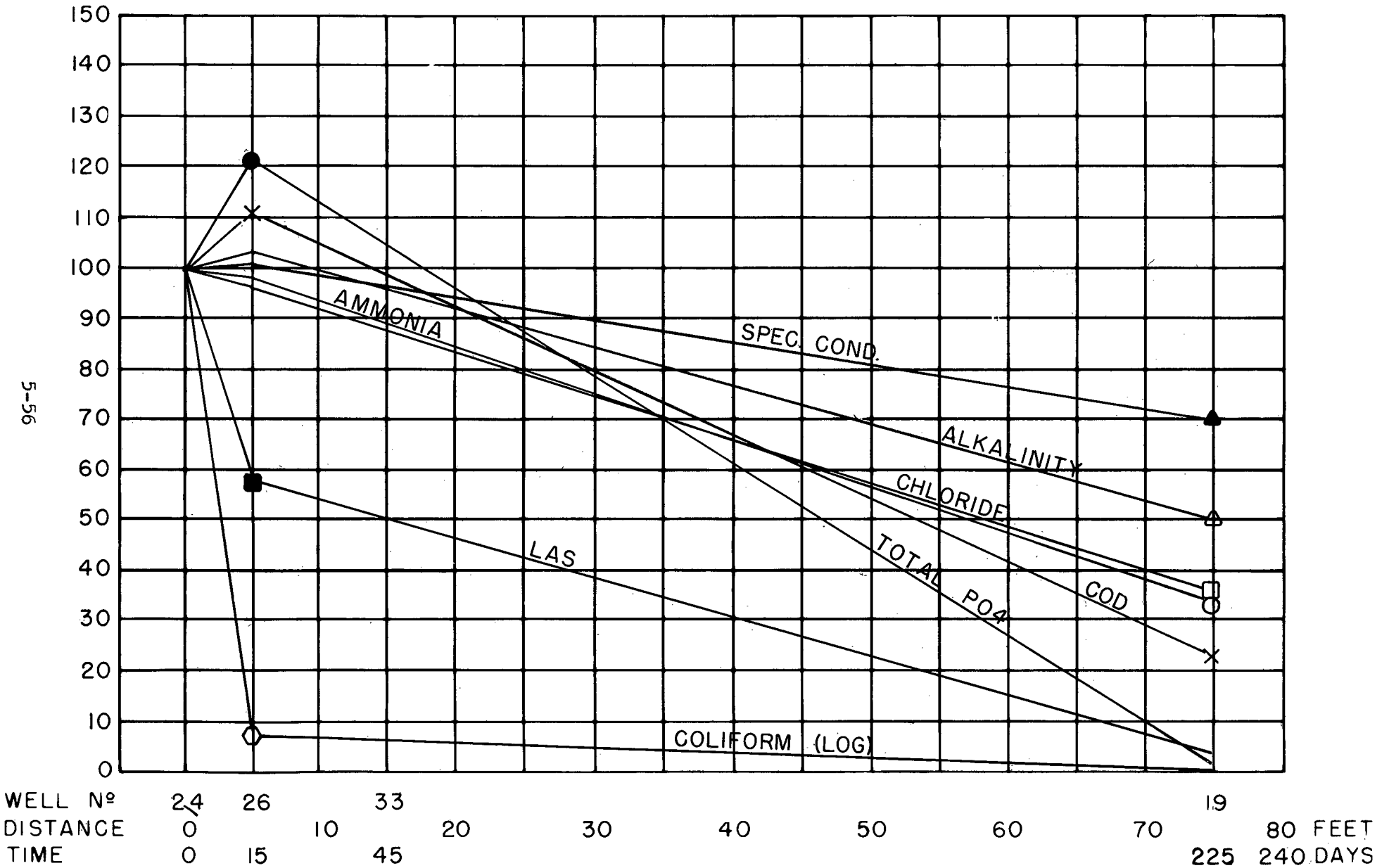

FIG. 5-29

LONG ISLAND GROUND WATER POLLUTION STUDY
 REDUCTION VERSUS TRAVEL TIME
 SOAP IN USE (6/12/1963 - 3/1/1964)
 SITE N° 1- BROOKHAVEN, SUFFOLK COUNTY, N. Y.

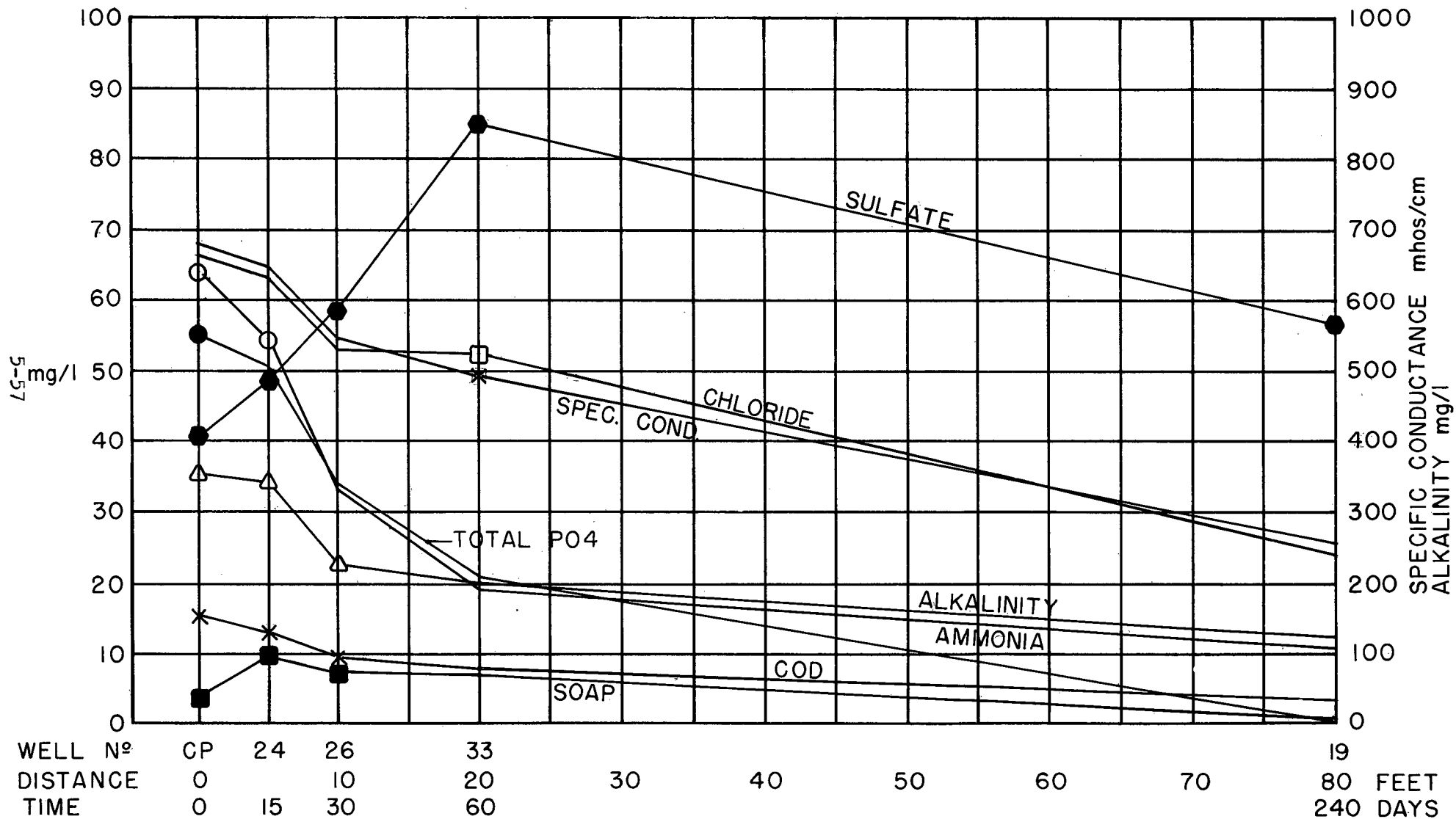

FIG. 5-30

LONG ISLAND GROUND WATER POLLUTION STUDY
 PERCENT REMAINING OF FIRST WELL CONCENTRATION
 SOAP IN USE (6/12/1963-3/1/1964)
 SITE N° 1 - BROOKHAVEN, SUFFOLK COUNTY, N. Y.

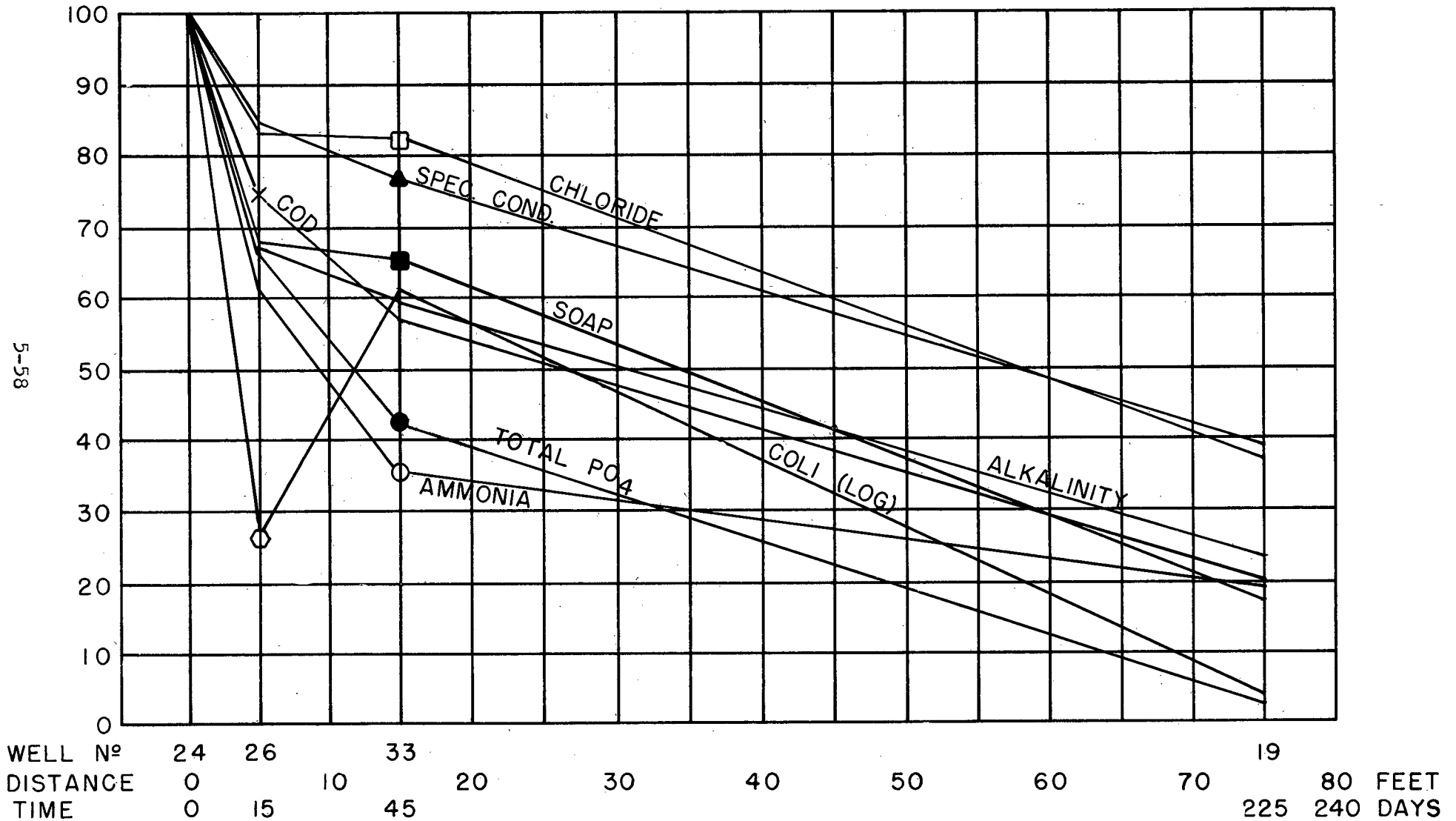

FIG. 5-31

LONG ISLAND GROUND WATER POLLUTION STUDY
 REDUCTION VERSUS TRAVEL TIME
 LAS IN USE (3/1/1964 - 9/2/1964)
 SITE N° 1 - BROOKHAVEN, SUFFOLK COUNTY, N. Y.

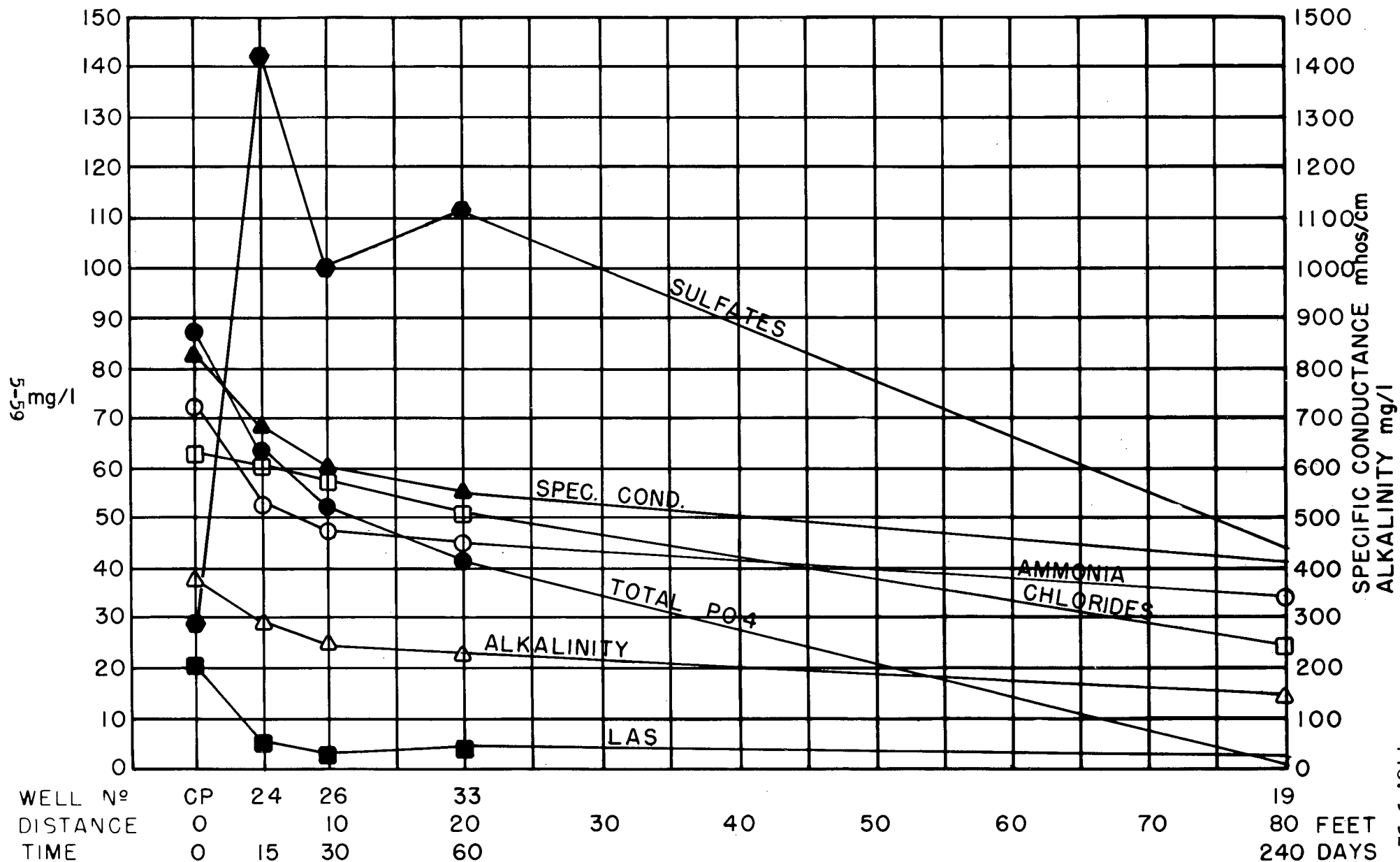

FIG. 5-32

LONG ISLAND GROUND WATER POLLUTION STUDY
 PERCENT REMAINING OF FIRST WELL CONCENTRATION
 LAS IN USE (3/1/1964 - 9/2/1964)
 SITE N° 1 - BROOKHAVEN, SUFFOLK COUNTY, N. Y.

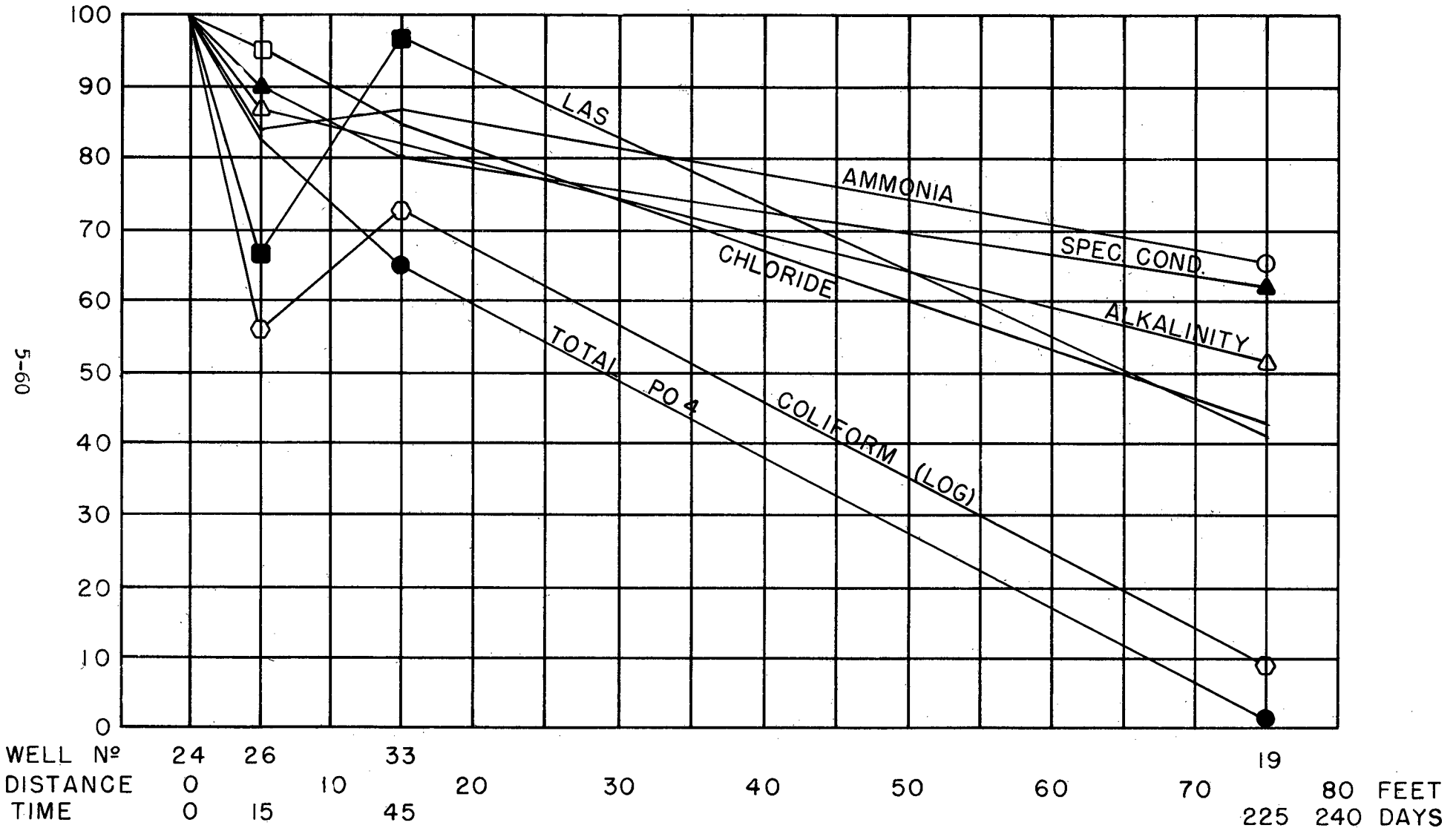

FIG. 5-33

LONG ISLAND GROUND WATER POLLUTION STUDY
 REDUCTION VERSUS TRAVEL TIME
 AS IN USE (9/2/1964-11/30/1964)
 SITE N° 1- BROOKHAVEN, SUFFOLK COUNTY, N. Y.

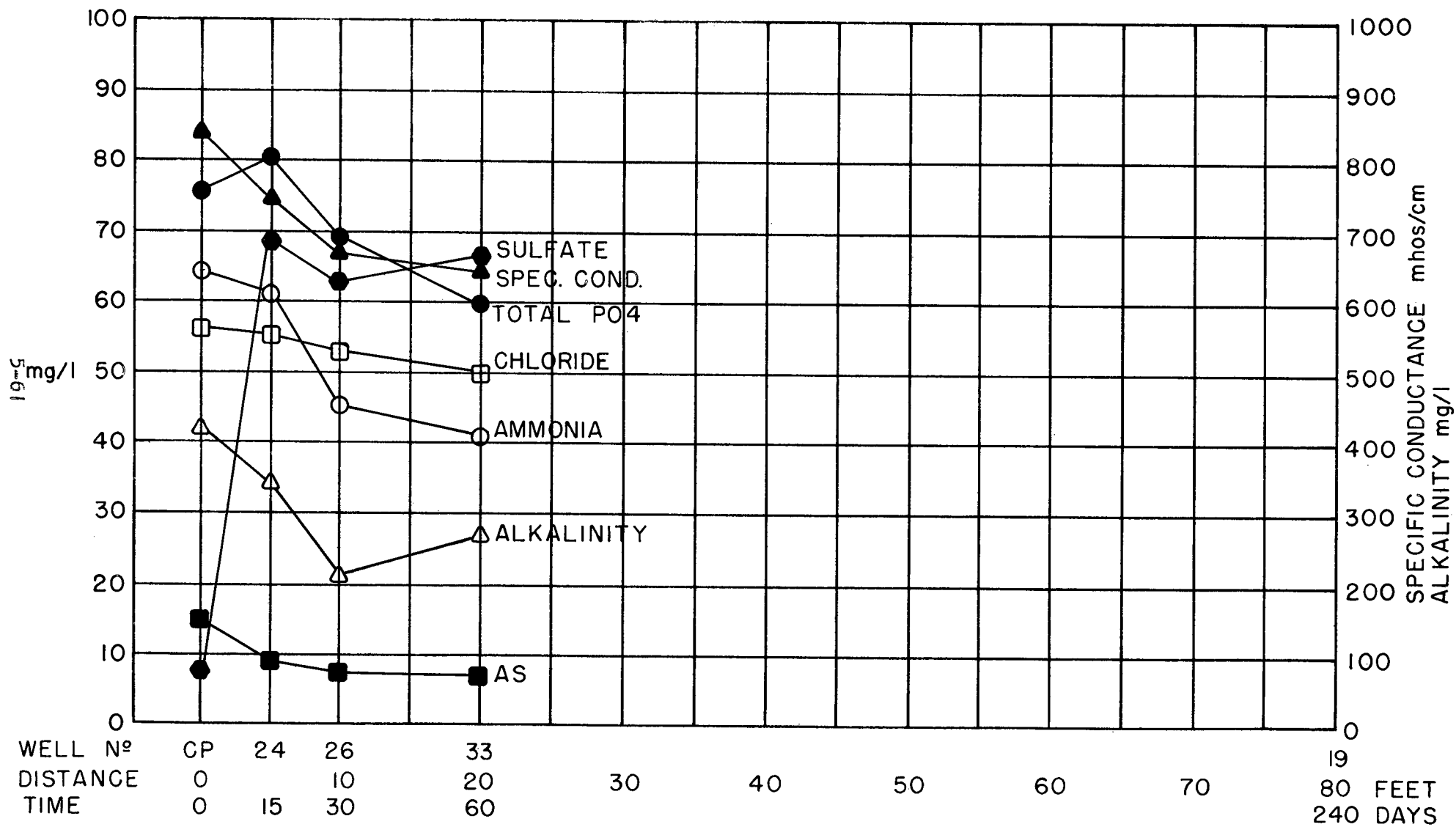

FIG. 5-34

LONG ISLAND GROUND WATER POLLUTION STUDY
 PERCENT REMAINING OF FIRST WELL CONCENTRATION
 AS IN USE (9/2/1964-11/30/1964)
 SITE N° 1 - BROOKHAVEN, SUFFOLK COUNTY, N. Y.

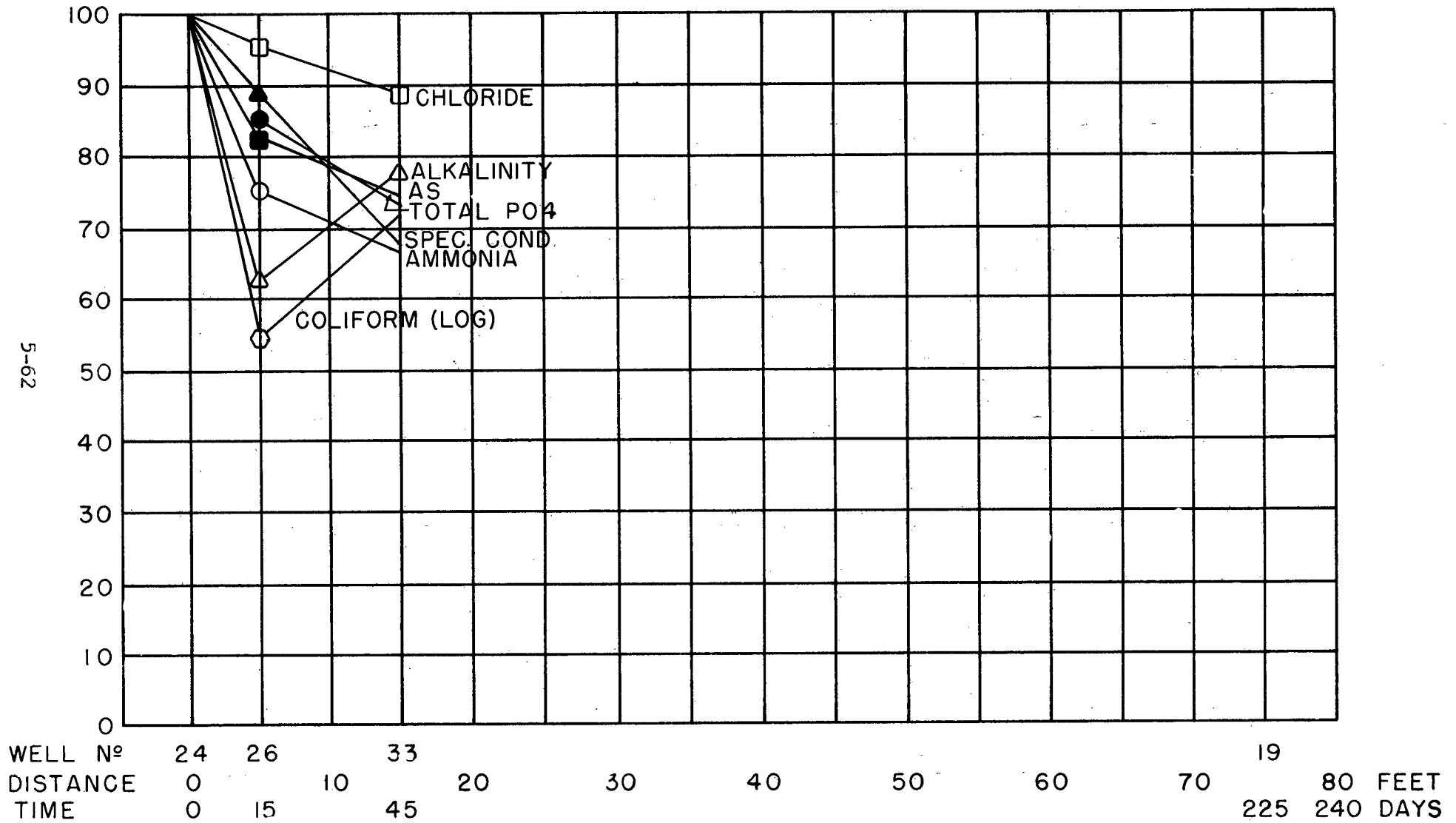

FIG. 5-35

DESCRIPTION AND DEVELOPMENT

PART 6 - SITE 2

Site No. 2 is located on the south side of Arlington Road, west of Avenue B in West Babylon, Long Island, New York. The family consists of two adults and five children. The house was approximately five years old at the time testing was commenced. The family was supplied with the standard ABS product and commenced its use on February 12, 1963. (Figure 6-1, 2)

The detergent products employed, quantity used and corresponding water use are given in Table 4-3.

Special interest on this site was directed to the use of a Sucrose Ester base surfactant. The product was supplied by the Sugar Research Foundation, New York City. Extensive deliberation took place on the detergency of the Sucrose Ester material. After several meetings on the subject, it was determined to submit the product for testing by an independent research laboratory. A summary of the report by Harris Research Laboratories, Inc., follows:

"Standard heavy duty household laundering formulations were prepared from a series of well-characterized sucrose ester surfactants. The detergency and redeposition performance of these formulations was measured by the soil accumulation method, using for comparison standard formulations based on sulfated and sulfonated surfactants. Also measured were the lime soap dispersing power, and the tendency to leave the residual adsorbed deposits on the fabric. The sucrose ester series as a whole performed at least as well in detergency as the standard anionics, and retained their effectiveness at lower concentrations. They showed about the same, or slightly less, tendency than the anionic controls to build up organic residues on the fabric, both series being much superior to soap in this respect. In redeposition performance and lime soap dispersion the sucrose esters were outstandingly better than any of the standard anionic controls. Within the sucrose ester series, the C₁₈ esters gave generally better performance than the shorter chain esters, and the saturated esters tended to be better than the unsaturated."

ARLINGTON RD.

280' TO AVE. "B"

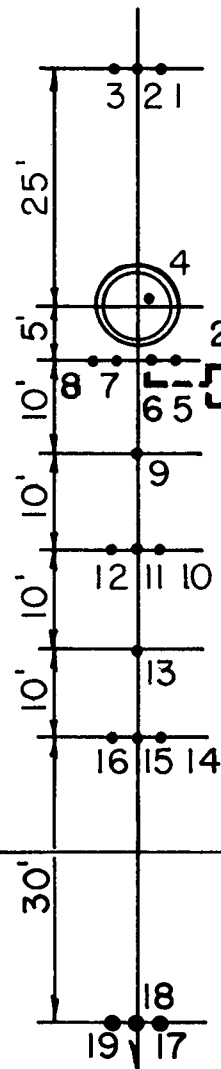

SEPTIC TANK

RESIDENCE

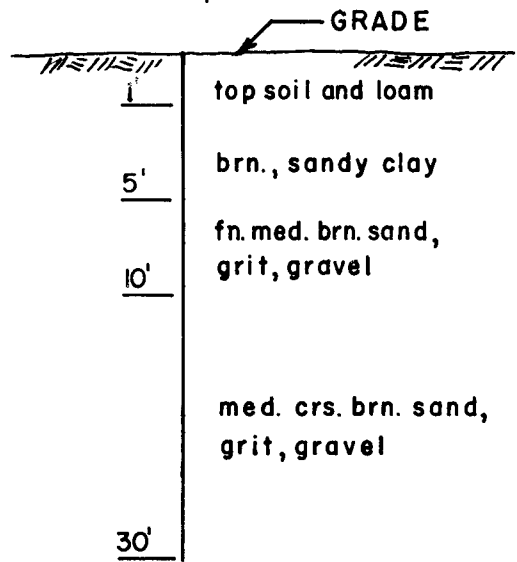

LOG of TEST WELL

fence

6-2

LONG ISLAND GROUND WATER POLLUTION STUDY
 SITE PLAN
 SITE 2. WEST BABYLON, SUFFOLK COUNTY

- TEST WELL
- ⊙ SUPPLY WELL
- ⊕ CESSPOOL

DIRECTION OF GROUND
 WATER FLOW

FIG. 6-1

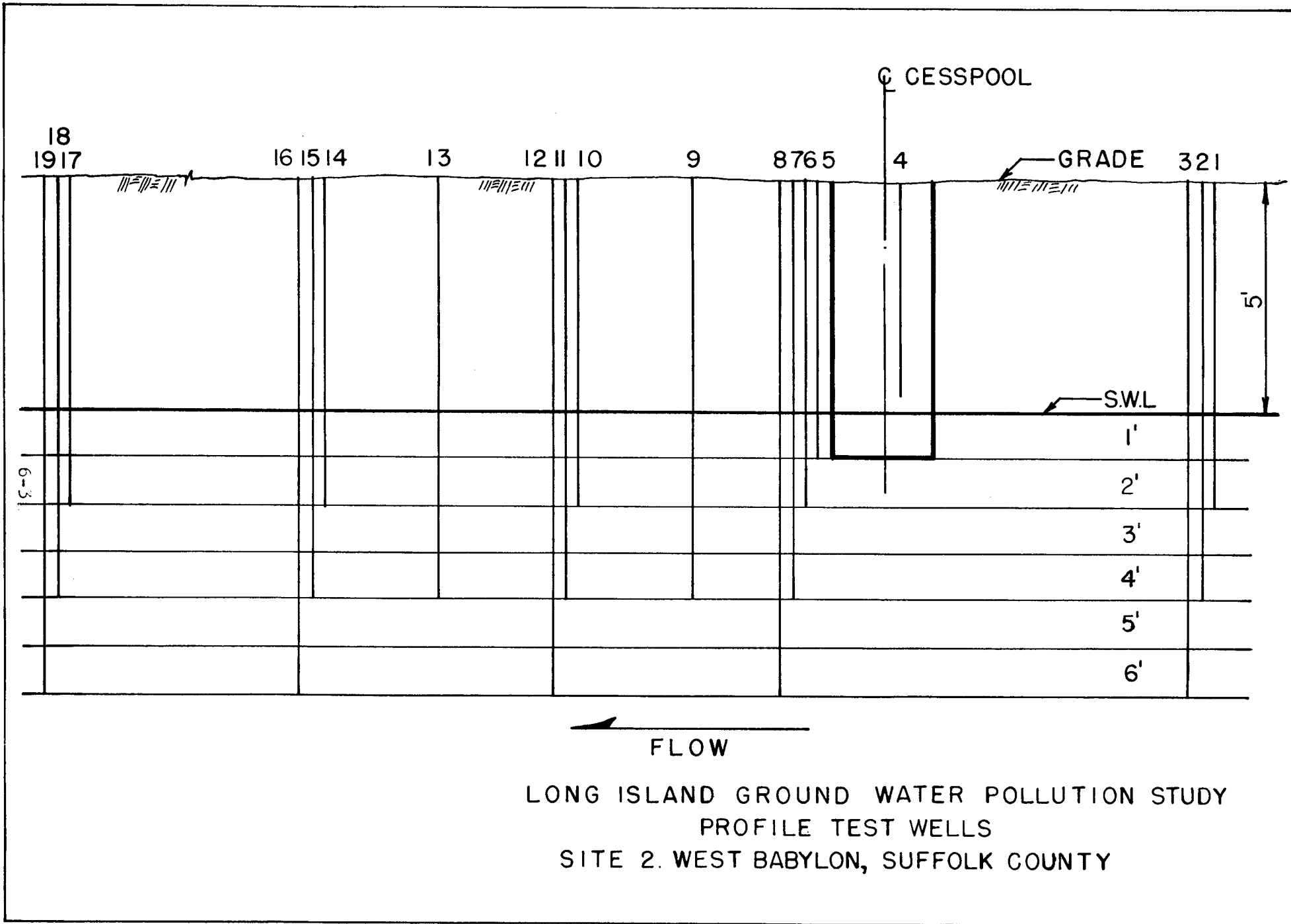

FIG. 6-2

The complete report is given in a paper titled "Performance Characteristics of Sucrose Ester Detergents", Swartz and Rader, presented to American Oil Chemists Society December 1964.

In view of the report confirming the detergency efficiency of the sucrose ester product, the Long Island Research Task Unit decided to accept the sucrose ester detergent for tests on Site No. 2.

The sewage disposal system consists of a 750-gallon septic tank followed by a single 8-foot diameter, 8 feet deep precast concrete cesspool extending two feet below the static water level. Water supply for the home is obtained through a 1 1/4 in diameter, 30 feet deep private well located on the northeast corner of the property. A water meter was installed on the discharge side of the pump in order to obtain the water use for the family. Prior to completion of the project the public water supply was extended into the area and the homeowner disconnected the private well. Ground water level observation wells were installed on and in the vicinity of the site.

Survey teams from the U.S. Geological Survey and the Suffolk County Health Department measured and plotted the ground water contours obtained from the test well observations. A plotting of the ground water contour indicated that the direction of flow of ground water in the area was south 14° 30' east. This directional line was staked out through the center of the cesspool.

A 30-foot deep core boring was drilled to establish the nature of the subsurface aquifers. Wash samples were taken at 2 1/2 feet intervals and coring attempted every 5 feet. The formations encountered were extremely coarse, and only one spoon sample was retrieved. The driller's log is as follows: 0 to 1 foot; topsoil and loam, 1 foot to 5 feet; brown sandy clay, 5 feet to 10 feet; fine to medium brown sand, grit and gravel, 10 feet to 30 feet; medium-course brown sand, grit and gravel. (Figure 6-3)

The ground water table elevation was established at 17.6 feet above mean sea level and varied from 4 feet to 5 feet below grade on the site.

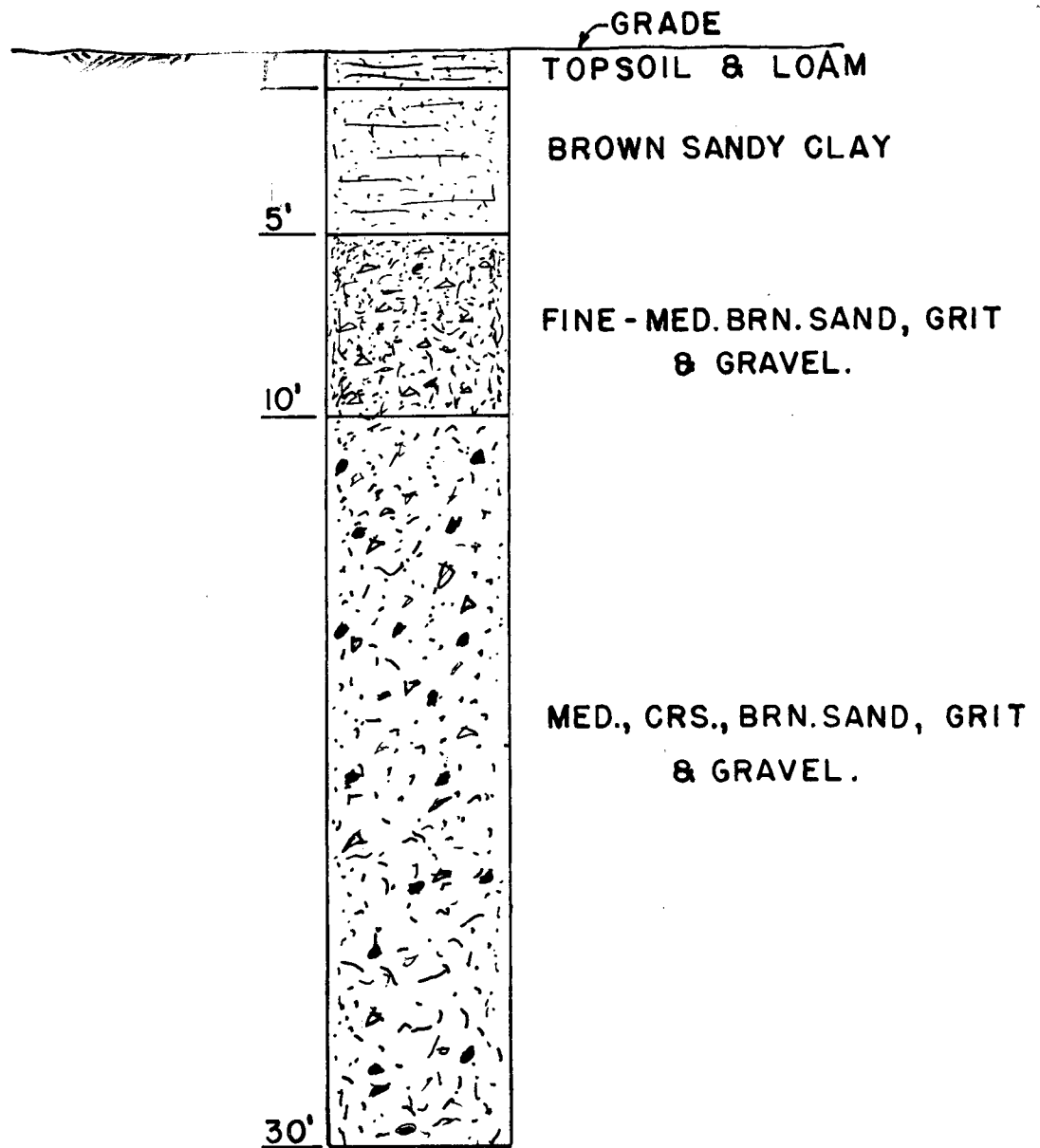

LONG ISLAND GROUND WATER POLLUTION STUDY

LOG OF TEST WELL

SITE # 2 W. BABYLON, SUFFOLK COUNTY

Five probe wells were installed along the ground water flow direction in order to establish the pattern of the cesspool effluent in the ground water body. The standard 1 1/4 inch well points were partially filled with lead to allow only a 6 inch effective open area exposed to the formation. The first well was placed 45 feet dowgradient from the cesspool and to a depth of 41 feet below grade. Samples were collected and field analyzed for ABS as an indicator of the pool effluent.

The second well was driven 20 feet downstream from the pool to a total depth of 39 feet and sampled 21 times during the installation. Twenty feet upstream from the cesspool, a 21-foot test well was driven and sampled at five formations. The remaining two test wells were placed at 15 to 35 feet dowgradient and sampled five and four times respectively during installation.

A rather high background pollution of the ground water was noticed, and the presence of ABS was detected to depths of 40 feet below grade at the southernmost probe well. Field tests were later confirmed in the Suffolk County Water Authority Laboratory.

The highest ABS readings were obtained between 2 and 6 feet below the static water level. This high concentration was considered evidence of the main body of the cesspool effluent.

Two holes were drilled through the cesspool cover. In one hole a 1 1/4 inch x 2 foot diameter long well point was set 6 feet below grade. In the other, an 8 inch adaptor pipe was installed for a liquid level recorder. When uncovered, the pool was close to overflowing and a scavenger was called in to pump out both the cesspool and the septic tank. Later, inspection of the pool indicated adequate leaching.

A total of 15 permanent wells were installed using 1 1/4 inch diameter x 1 foot long effective opening well points. Reference wells were placed 25 feet upstream from the pool at 2, 4, and 6 feet below the static water level. Four downstream groups of wells were placed 5, 15, 25, 35, and 65 feet from the

center of the pool at 2, 4 and 6 feet below the static water level. (Figure 6-1, 2)

On April 5, 1963, 6.25 pounds of sodium fluoride was dissolved in a 55-gallon drum and discharged into the cesspool. It was estimated that this dosage would result in approximately 800 mg/l of fluoride in the pool. Analysis of the cesspool contents of the following day showed a fluoride concentration of 350 mg/l.

Several sample runs were made on the test wells for phosphates prior to the fluoride dosing in order to obtain data on background interference in the fluoride analysis due to phosphates.

After the tracer introduction, samples from the wells which had indicated the highest levels of ABS were collected daily and analyzed for fluorides. The fluorides appeared in Well No. 9 on April 18, Well No. 11 on May 4, and Well No. 15 on June 4, 1963, a travel rate of 40 feet in 60 days or a ground water flow rate of 0.66 feet per day.

During the course of the studies it was necessary from time to time to pump out the disposal system and septic tank. This was particularly necessary for the cesspool which would reach overflow levels. A procedure which was employed successfully on a number of occasions was to aerate the bottom of the cesspool through the use of a compressor and a probe pipe. The aeration procedure usually resulted in a level drop of 4 to 5 feet following 2 - 3 hours aeration of the pool. When switching from one detergent product to another, the disposal system and septic tank were pumped out in order to obtain information on the rate of appearance of the new product in the disposal system.

The collection of samples on Site No. 2 was carried out through use of a common hand pitcher pump with the Lucite tube attachment for collection of bacteriological and dissolved oxygen samples. (Figure 3-3)

In November 1965 a sampling point was placed in the septic tank in order to obtain data on removals of sewage constituents in the septic tank.

Travel of Waste Slug

1. The sewage slug in the saturated soil zone was depressed as it traveled through the downstream sampling locations. At the first well group, the waste slug fluctuated between 2 through 4 feet below static water level and depressed to approximately 6 feet below SWL at the last observation well group, 65 feet downstream from the disposal system.

2. Travel between the first and last well groups generally resulted in an overall reduction in contaminants of sewage origin as a result of mixing with less contaminated ground water in addition to exchange and sorption processes.

3. Natural recharge of the upper glacial formation by precipitation did not appear to have any direct affect on dilution of the waste slug nor any role in depressing the slug through the downstream flow path. Density differences between the sewage slug and surrounding ground waters is believed to be the prime factor resulting in sinking of the waste slug through the downstream observation wells. As mixing and dilution of the slug progresses, density differences are decreased causing the diminishment of the downward force driving the waste-ground water mixture deeper.

4. Presence of an upgradient sewage slug approximately 6 feet below SWL was observed in background observation well No. 3. (Table 4-1) Downstream sampling wells were not driven deep enough to enter the upgradient slug as it passed beneath the onsite slug. Site No. 2 was located in a densely populated area; therefore, subject to upgradient or offsite pollutional sources.

Chlorides

1. Chloride concentrations in the disposal system ranged between 47.0 and 60.0 mg/l varying with the surfactant in use. (Table 6-1) Background wells indicate chloride concentrations of 28.0 in the upgradient waste slug and 13.0 in surrounding ground waters.

2. Movement of the sewage slug between the cesspool and first well group resulted in a 5-12 percent increase in chloride concentration during the use of all

Table 6-1
SITE 2
OBSERVATION WELL CONCENTRATIONS

V=0.67 ft./day	Cesspool 0	#6 5'	#11 25'	#15 45'	#17 65'
1. ABS (MBAS)	41.1	40.2	28.9	30.4	12.1
Ammonia	51.6	60.1	54.0	51.7	50.7
Chlorides	60.0	67.2	61.0	61.4	54.5
Total PO ₄	74.0	69.0	42.0	25.8	0.19
Spec. Cond.	558.0	623.0	643.0	610.0	652.0
Alkalinity	293.0	384.0	358.0	340.0	341.0
Sulfates	177.0	72.5	66.0	57.8	37.3
Coliform	1.23x10 ⁶	2.07x10 ⁶	4.22x10 ⁴	1.33x10 ⁵	84.3
(Log Avg.)					
Nitrites	0.01	0.19	0.12	0.05	0.04
Nitrates	0.1	0.1	0.1	0.1	0.18
COD	233.0	224.0	158.0	151.0	165.0
2. LAS (MBAS)	24.3	22.3	20.3	19.5	14.3
Ammonia	56.5	58.9	56.7	56.7	52.6
Chlorides	53.7	57.1	51.8	51.6	46.3
Total PO ₄	71.0	64.6	22.0	1.5	0.19
Spec Cond.	640.5	618.0	632.0	575.0	511.0
Alkalinity	333.0	338.0	303.0	322.0	301.0
Sulfates	65.2	64.5	108.0	112.0	83.2
Coliform	1.74x10 ⁶	9.32x10 ⁴	1.72x10 ⁵	143.5	24.1
(Log Avg.)					
Nitrites	0.01	0.04	0.07	0.02	0.02
Nitrates	0.1	0.1	0.1	0.1	0.1
COD	142.0	110.0	96.9	103.0	85.0
3. AS (MBAS)	13.4	16.3	12.5	12.1	10.2
Ammonia	52.5	62.2	57.0	50.0	49.3
Chlorides	47.0	49.2	47.5	46.5	40.0
Total PO ₄	81.5	70.0	42.5	3.7	0.09
Spec. Cond.	675.0	710.0	665.0	652.0	595.0
Alkalinity	295.0	380.0	344.0	342.0	332.0
Sulfates	34.0	64.0	103.0	88.0	64.4
Coliform	3.34x10 ⁵	1.04x10 ⁵	3283.	1763.	640.
(Log Avg.)					
Nitrites	0.01	0.06	0.07	0.05	0.02
Nitrates	0.13	3.73	4.97	1.72	3.33
COD					

Table 6-1 (continued)
 SITE 2
 OBSERVATION WELL CONCENTRATIONS

	Septic Tank	Cesspool 0	#6 5'	#11 25'	#15 45'	#17 65'
4. Soap (MBAS)		2.3	8.8	7.0	6.7	7.8
Ammonia		63.0	69.2	60.2	53.3	35.5
Chlorides		53.8	59.8	55.4	53.9	40.7
Total PO ₄		47.5	53.0	30.7	4.3	0.6
Spec. Cond.		760.0	814.0	659.5	660.6	440.0
Alkalinity		380.0	455.0	390.0	380.0	254.0
Sulfates		8.2	30.4	51.5	46.5	59.0
Coliform		10.16x10 ⁶	1.03x10 ⁵	2.68x10 ³	282.	235.
(Log Avg.)						
Nitrites		0.02	0.03	0.05	0.03	0.02
Nitrates		0.1	1.04	2.46	2.6	3.1
COD						
5. LAS ₂ (MBAS)		18.4	12.7	9.9	4.2	5.2
Ammonia		58.9	63.1	59.4	35.0	11.1
Chlorides		50.6	53.1	50.9	44.1	33.3
Total PO ₄		86.0	78.4	58.9	2.8	0.03
Spec. Cond.						
Alkalinity		385.0	418.0	380.0	222.0	104.0
Sulfates		10.9	14.6	70.2	100.5	65.5
Coliform		1.39x10 ⁶	5.16x10 ⁴	1060.	20.5	25.
(Log Avg.)						
Nitrites		0.02	0.03	0.07	0.26	0.08
Nitrates		0.1	0.3	4.4	6.5	4.7
COD		184.0	83.0	80.0	39.0	32.0
6. Sucrose Ester (MBAS)	3.3	5.3	13.3	13.5	6.5	3.6
Ammonia	63.5	60.0	60.5	62.5	35.4	13.1
Chlorides	56.0	55.5	52.7	52.0	50.0	36.9
Total PO ₄	113.0	122.0	110.0	74.3	8.0	0.06
Spec. Cond.						
Alkalinity	356.0	345.0	418.0	380.0	279.0	134.0
Sulfates	92.8	29.0	42.0	102.0	125.0	104.0
Coliform	1.56x10 ⁶	1.67x10 ⁶	7.96x10 ⁴	788.	187.	78.3
(Log Avg.)						
Nitrites	0.02	0.02	0.03	0.12	0.11	0.02
Nitrates	0.07	0.07	0.06	7.5	42.6	0.84
COD	270.0	236.0	159.0	125.0	40.5	23.4

surfactants except Sucrose Ester. (Table 6-2)

3. Travel through the downstream saturated soil zone, first to last well group, resulted in overall reductions of 18.9 to 37.2 percent average rates of chloride (Table 6-1, 2 Figure 6-4, 5) reduction being as follows:

	<u>Average Value</u>		
ABS	0.31%/ft.	0.21%/day	0.21/mg/l/ft.
LAS ₁	0.31	0.21	0.18
AS	0.33	0.22	0.15
Soap	0.53	0.36	0.32
LAS ₂	0.61	0.41	0.33
Sucrose Ester	0.51	0.34	0.26

The reduction in chloride concentration is generally accomplished by mixing with less contaminated waters and considered to be a measure of dilution.

4. A pronounced difference in the rates of chloride reduction resulted during the use of the final three surfactants (Soap, LAS₂ and Sucrose Ester). The rate of reduction or dilution during the use of the final three surfactants was approximately double the chloride reduction experienced with the initial three surfactants.

In the period in which the final three surfactants were used, a drop in the water table levels occurred. It is believed that the result of the drop was a vertical movement of the center of the waste away from the sampling point. Prior to the use of the final three surfactants, the homeowner switched from an individual well water system (CL = 25+mg/l) to the public water supply (Cl = 5+ mg/l), resulting in an approximate decrease of 20 mg/l chlorides in the waste entering the cesspool, further accounting for chloride decreases.

Infrared Analysis

1. Infrared analysis for the percent branched material, ABS, in downstream wells indicated 90 to 56 percent ABS still present at downstream sampling locations during the use of LAS surfactant. The first infrared samples collected during

Table 6-2

PERCENT REMAINING OF FIRST WELL CONCENTRATION

	#6 0	#11 20'	#15 40'	#17 60'
1. ABS (MBAS)	100.0	71.9	75.6	30.0
Ammonia		89.9	86.0	84.4
Chlorides		90.8	91.4	81.1
Total PO ₄		60.9	37.4	0.4
Spec. Cond.		+103.2	98.4	+104.6
Alkalinity		93.2	88.6	88.8
Coliform		2.0	0.1	0.1
(Log Avg.)				
COD		70.5	67.4	73.6
2. LAS (MBAS)	100.0	91.0	87.4	64.1
Ammonia		94.5	94.5	89.3
Chlorides		90.7	90.4	81.1
Total PO ₄		36.0	2.5	0.5
Spec. Cond.		+102.0	93.0	82.7
Alkalinity		89.7	95.3	89.1
Coliform		2.0	0.3	0.1
(Log Avg.)				
COD		88.1	93.7	77.4
3. AS (MBAS)	100.0	76.7	74.2	62.6
Ammonia		91.6	80.4	79.2
Chlorides		95.4	93.4	80.3
Total PO ₄		60.7	5.4	0.3
Spec. Cond.		93.7	91.8	83.8
Alkalinity		90.5	90.0	87.4
Coliform		3.4	1.9	0.6
(Log Avg.)				
COD				
4. Soap (MBAS)	100.0	79.6	76.1	88.6
Ammonia		87.0	77.0	51.3
Chlorides		92.6	90.1	68.1
Total PO ₄		57.9	8.0	0.1
Spec. Cond.		80.9	81.0	53.9
Alkalinity		85.7	83.5	55.8
Coliform		2.8	0.5	0.4
(Log Avg.)				
COD				

Table 6-2 (continued)

PERCENT REMAINING OF FIRST WELL CONCENTRATION

	#6 0	#11 20'	#15 40'	#17 60'
5. LAS (MBAS)	100.0	78.0	33.0	41.0
Ammonia		94.1	55.5	17.5
Chlorides		95.9	83.1	62.8
Total PO ₄		75.1	3.5	0.1
Spec. Cond.				
Alkalinity		90.9	53.0	24.7
Coliform		2.0	0.1	0.1
(Log Avg.)				
COD		96.4	47.0	38.5
6. Sucrose Ester (MBAS)	100.0	+101.5	49.0	27.0
Ammonia		+103.3	58.5	21.5
Chlorides		98.7	95.7	70.0
Total PO ₄		67.5	7.0	0.1
Spec. Cond.				
Alkalinity		90.9	66.8	32.0
Coliform		1.0	0.5	0.1
(Log Avg.)				
COD		78.6	25.5	14.8

LONG ISLAND GROUND WATER POLLUTION STUDY
 REDUCTION VERSUS TRAVEL TIME
 CHLORIDES (2/12/1963-3/14/1966)
 SITE N° 2 - WEST BABYLON, SUFFOLK COUNTY, N. Y.

6-14

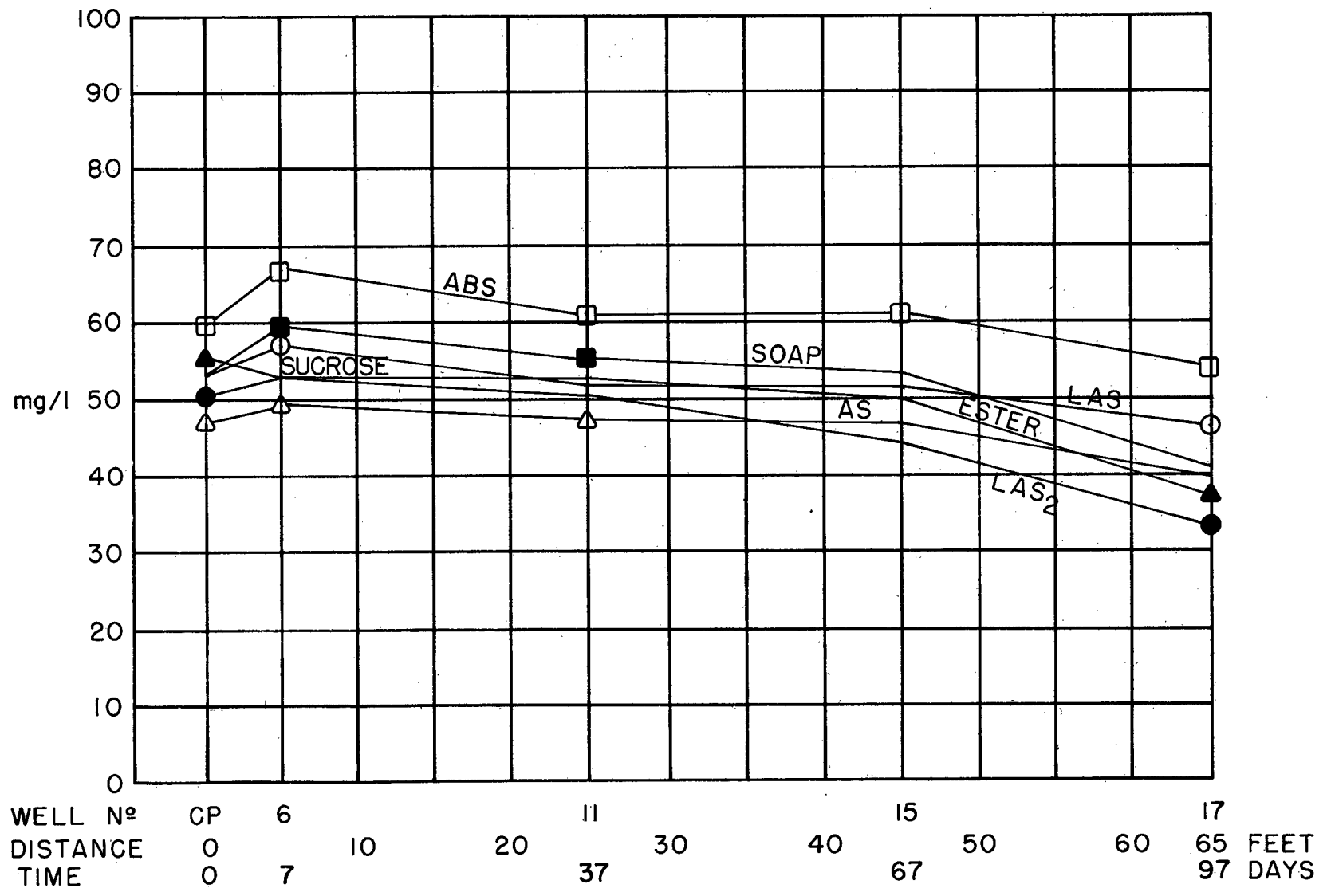
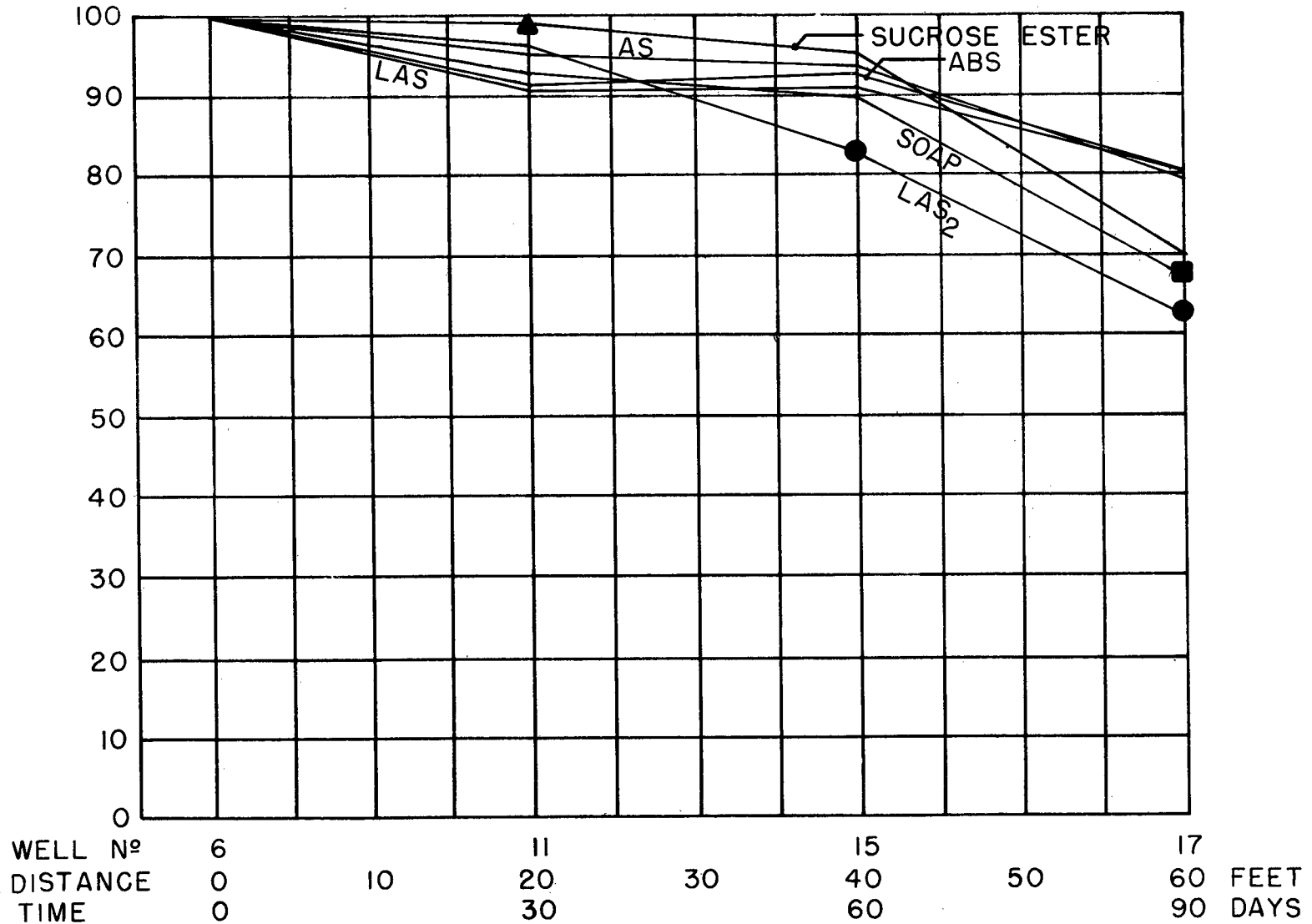

FIG. 6-4

LONG ISLAND GROUND WATER POLLUTION STUDY
 PERCENT REMAINING OF FIRST WELL CONCENTRATION
 CHLORIDES (2/12/1963-3/14/1966)
 SITE N° 2 - WEST BABYLON, SUFFOLK COUNTY, N. Y.



6-15

FIG. 6-5

the use of LAS were obtained approximately three months after ABS surfactant was discontinued as the household washing compound. Prior to the study ABS was used as the household washing compound; therefore, the downstream soil system was assumed to be saturated with ABS.

2. Average percent branched material, ABS, present at downstream sampling locations during LAS usage were:

<u>Sampling Date</u>	<u>Sampling Location</u>		
	<u>Well #9</u> 15'	<u>Well #11</u> 30'	<u>Well #13</u> 45'
9/9/63	79.5%	83%	76%, 90%
10/8/63	80	77	80
10/21/63	71	69	68
12/18/63	72	68	74
1/64	68	68	77
2/26/64	24	57	56
8/28/64	46		

3. Based upon ground water velocities, approximately 90 days (3 months) were required for the waste slug to completely travel through the downstream flow path. During the collection of infrared samples two complete passes of the waste slug were accomplished, resulting in about a 25 percent decrease in the quantity of ABS present at a particular well. Assuming complete ABS saturation at the beginning of the study, about 20 percent of the branched material was flushed out, desorbed, during the time ABS was discontinued as the washing compound and collection of the infrared samples (3 months).

4. Tracing slugs of waste through the downstream flow path resulted in general decreases in the percent branched material, ABS, at each succeeding downstream well group.

Sampling Location and Date

<u>Run Number</u>	<u>Well #9</u>		<u>Well #11</u>		<u>Well #13</u>	
	<u>15'</u>	<u>%ABS</u>	<u>30'</u>	<u>%ABS</u>	<u>45'</u>	<u>%ABS</u>
1	9/9/63	79.5%	10/8/63	77%	10/21/63	68%
2	10/8/63	80	10/21/63	69	12/18/63	74
3	12/18/63	72	1/64	68	2/26/64	56

5. Generally, the percent branched material, ABS, present at a particular sampling location tended to decrease with time following the use of ABS surfactant as a washing compound.

6. Desorption of branched material (ABS) resulted at a larger rate immediately after ABS surfactant was discontinued as the household washing compound. A 20 percent decrease in branched material (ABS) resulted after the first three months of LAS₁ following ABS usage. The subsequent six months of LAS₁ usage only resulted in an additional 25 percent decrease in branched material. (ABS)

MBAS as ABS

1. MBAS reported as ABS in the disposal system varied considerably depending upon the surfactant being used and averaged between 2.3 and 41.1 mg/l. (Table 6-1) Background observation wells indicated average MBAS concentrations of 3.5 and 0.02 mg/l in the upgradient waste slug and peripheral ground waters, respectively.

2. In the flow region around the cesspool reduction characteristics in MBAS varied significantly. During the use of ABS, LAS₁, and LAS₂, MBAS levels reduced 2-31 percent in concentration while MBAS levels during use of the remaining surfactants (AS, Soap, Sucrose Ester) actually increased through the same flow region. (Table 6-2, Figure 6-6, 7)

3. Surfactants showing increases in MBAS concentration in the initial flow path were formulations with relatively low MBAS levels within the disposal system. Soap and Sucrose Ester compounds had average MBAS levels of 2.3 and 5.3 mg/l in the cesspool and increased at the first well group to 8.8 and 13.3 mg/l respectively. Desorption of branched material, ABS, in the cesspool soil

LONG ISLAND GROUND WATER POLLUTION STUDY
 REDUCTION VERSUS TRAVEL TIME
 MBAS REPORTED AS ABS (2/12/1963 - 3/14/1966)
 SITE N° 2 - WEST BABYLON, SUFFOLK COUNTY, N. Y.

81-9

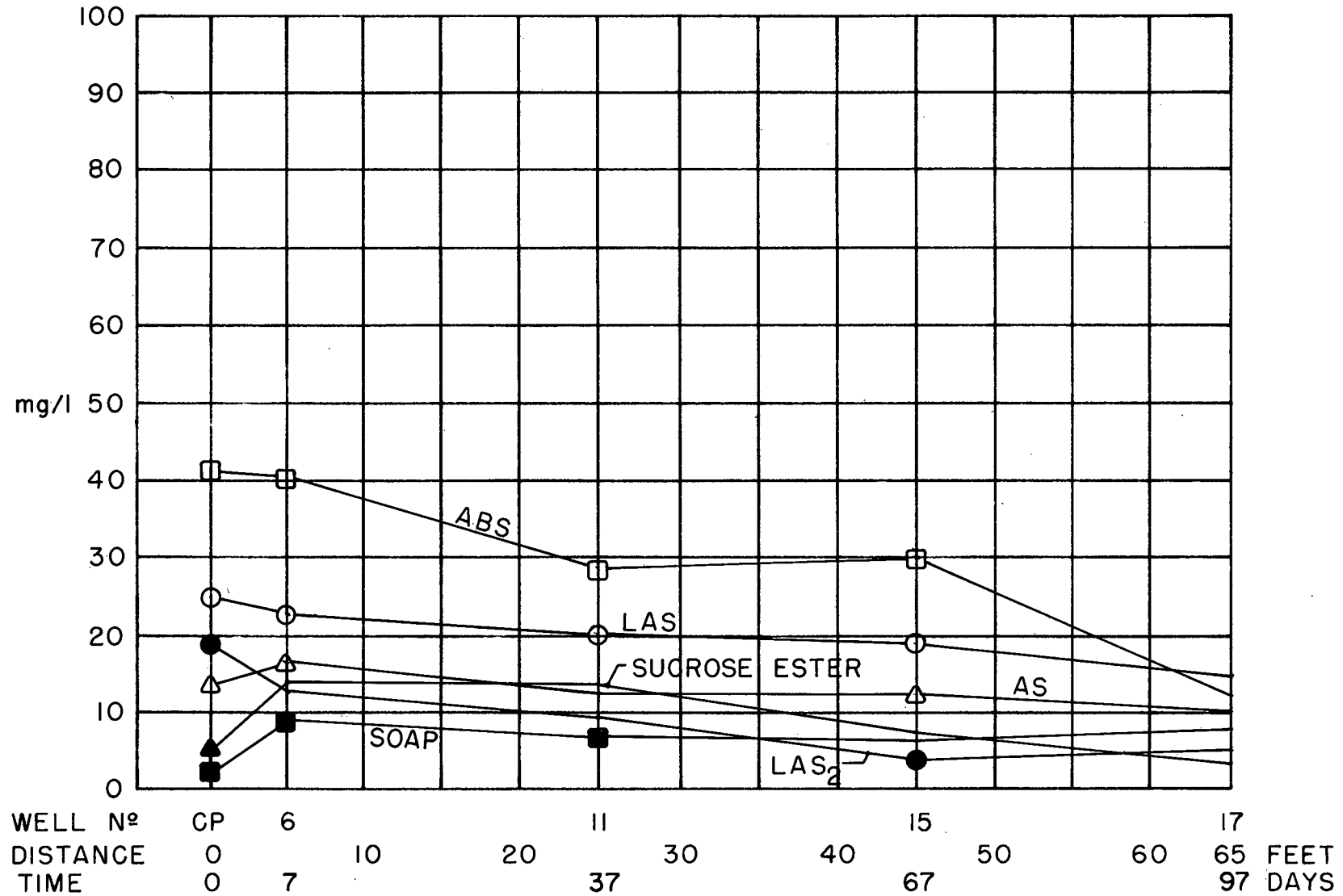
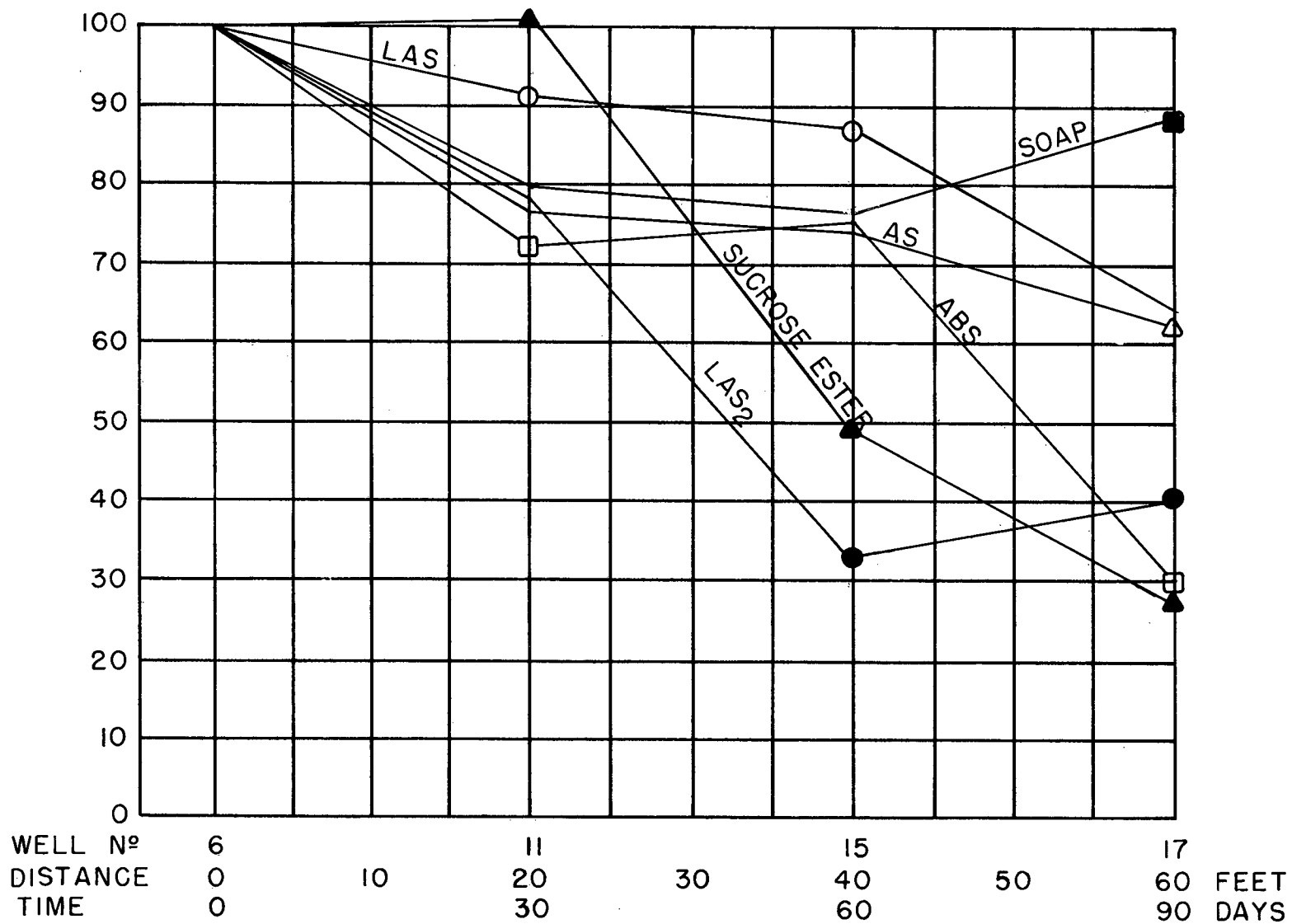

FIG. 6-6

LONG ISLAND GROUND WATER POLLUTION STUDY
 PERCENT REMAINING OF FIRST WELL CONCENTRATION
 MBAS REPORTED AS ABS (2/12/1963-3/14/1966)
 SITE N° 2 - WEST BABYLON, SUFFOLK COUNTY, N. Y.



6-19

FIG. 6-7

region was undoubtedly the factor causing increased MBAS levels. During the use of LAS, infrared analysis indicated between 46 and 90 percent branched material (ABS) still present in the saturated soil zone.

4. Movement of the waste slug through the downstream observation wells resulted in reductions in MBAS concentrations. Average rates of reduction in MBAS between the first and last well groups 60 feet travel distance was:

Average Values

ABS	1.17%/ft.	0.78%/day	0.47 mg/l/ft.
LAS ₁	0.60	0.40	0.13
AS	0.63	0.42	0.11
Soap	0.19	0.13	0.02
LAS ₂	0.98	0.66	0.13
Sucrose Ester	1.21	0.81	0.16

5. Compensating for dilution, based upon reductions in chloride reductions, resulted in average net rates of MBAS reduction (% MBAS - % Chlorides) due to factors other than dilution through the downstream flow path of:

Average Values

ABS	0.86%/ft.	0.57%/day
LAS ₁	0.29	0.19
AS	0.30	0.20
Soap	Dilution Rates Exceeded Reduction Rates	
LAS ₂	0.37	0.25
Sucrose Ester	0.70	0.47

6. Net reductions in MBAS concentrations (% MBAS - % Chlorides) does not distinguish between MBAS reductions due to adsorption and/or biodegradation.

7. The second usage of LAS surfactant (LAS₂) resulted in substantially lower MBAS concentrations in the cesspool and downstream observation wells.

During both uses of LAS the water consumption increased approximately 30 percent, while the product use was approximately 20 percent less than with ABS or AS, thus

accounting for the generally lower MBAS levels during use of LAS.

Prior to the second use of LAS, there was a 16-month period during which AS and then Soap was employed. The purging of the saturated zone by low level MBAS waste slug resulted in desorption of previously deposited MBAS materials with subsequent improvement of the soil's adsorptive capacities. It is believed that this process accounted for the generally low MBAS results during the second use of LAS.

8. Increased MBAS concentrations between the cesspool and first well group, during the use of surfactants showing low MBAS levels in the cesspool indicated that MBAS reductions and associated rate functions in the saturated zone are undoubtedly subject to interferences by desorbed branched material.

9. Lower MBAS levels in the cesspool and downstream wells occurred upon changing from ABS to other surfactants. A decrease in MBAS concentrations in the downstream wells occurred with each successive surfactant until an MBAS level was attained where desorption of branched material (ABS) was the principal source of the MBAS material.

10. After changing household washing compounds, the cesspool and downstream wells required about 1 - 2 months to attain new quasi-steady state conditions with respect to MBAS levels. Reduction in MBAS concentrations were most pronounced when switching to and from Soap and Sucrose Ester formulations.

11. Although large bacterial populations existed in the initial downstream flow path, a relationship between bacterial populations and MBAS levels was not apparent.

Dissolved Oxygen

1. Background observation wells indicated a relatively large range of average dissolved oxygen concentrations being between 0.30 and 3.1 mg/l. (Table 4-5) Presence of the background waste slug was reflected by the low dissolved oxygen level, 0.30 mg/l, in Well No. 2. Background wells 1 and 3, being above and below the waste slug, measured significant average dissolved oxygen content being

1.2 and 3.1 mg/l, respectively.

2. All downstream sampling wells were virtually void of dissolved oxygen, values ranging between 0.0 and 0.7 mg/l. The low dissolved oxygen concentrations were probably caused by a highly concentrated waste slug located between 2 and 6 feet below static water level.

3. There was no evidence of increasing dissolved oxygen levels, re-oxygenation of the polluted waters as the slug traveled downstream.

pH

1. Background observation wells which were generally free of sewage contaminants had a pH range of 5.0 to 6.8. Both the septic tank and cesspool indicated an average pH 6.5 to 7.2, while downstream ground waters indicated the influence of the sewage slug by increased pH levels to pH 6.0 to 7.0 at the downstream observation wells.

Ammonia

1. In the disposal system free ammonia concentrations ranged between 51.6 and 63.0 mg/l. (Table 6-1) Background test wells indicate free ammonia levels of 11.0 and 0.35 mg/l in the upgradient waste slug and surrounding ground waters respectively.

2. Increases in free ammonia concentrations developed in travel of the sewage slug from the cesspool to first downstream well group during the use of all surfactants. Within this initial 5 foot travel distance, ammonia increases ranged between 0.8 and 18.5 percent. (Table 6-1 Figure 6-8 through 15; 6-27 thru 38)

3. The increase in free ammonia was due to the conversion of organic nitrogen into ammonia at the cesspool-soil interface where free oxygen was believed to exist.

4. Travel of the sewage slug through the entire saturated soil zone, first to last well groups, resulted in overall rates of ammonia reductions as follows:

LONG ISLAND GROUND WATER POLLUTION STUDY
 REDUCTION VERSUS TRAVEL TIME
 AMMONIA (2/12/1963-3/14/1966)
 SITE N° 2 - WEST BABYLON, SUFFOLK COUNTY, N. Y.

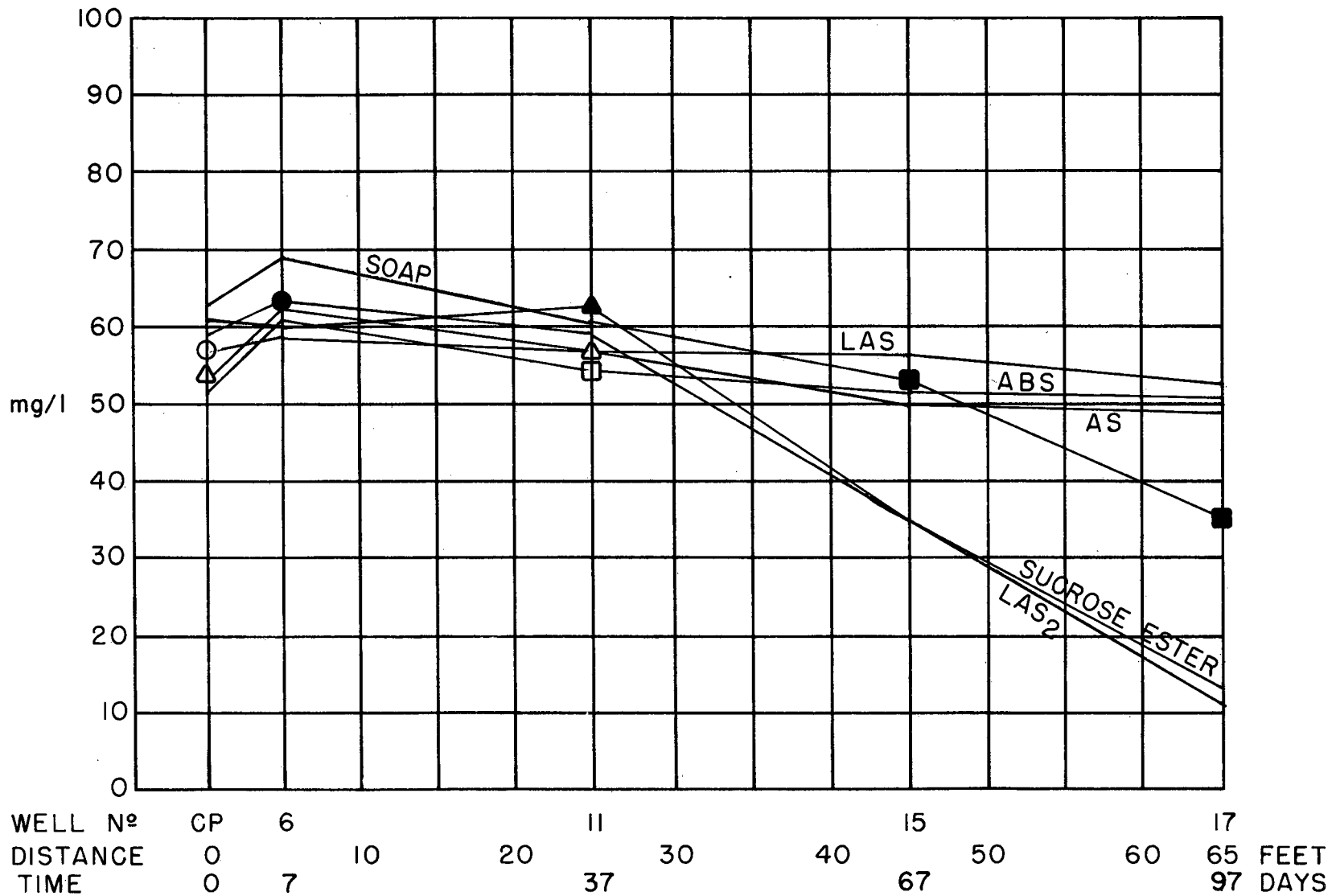

6-23

FIG. 6-8

LONG ISLAND GROUND WATER POLLUTION STUDY
 PERCENT REMAINING OF FIRST WELL CONCENTRATION
 AMMONIA (2/12/1963-3/14/1966)
 SITE N° 2 - WEST BABYLON, SUFFOLK COUNTY, N. Y.

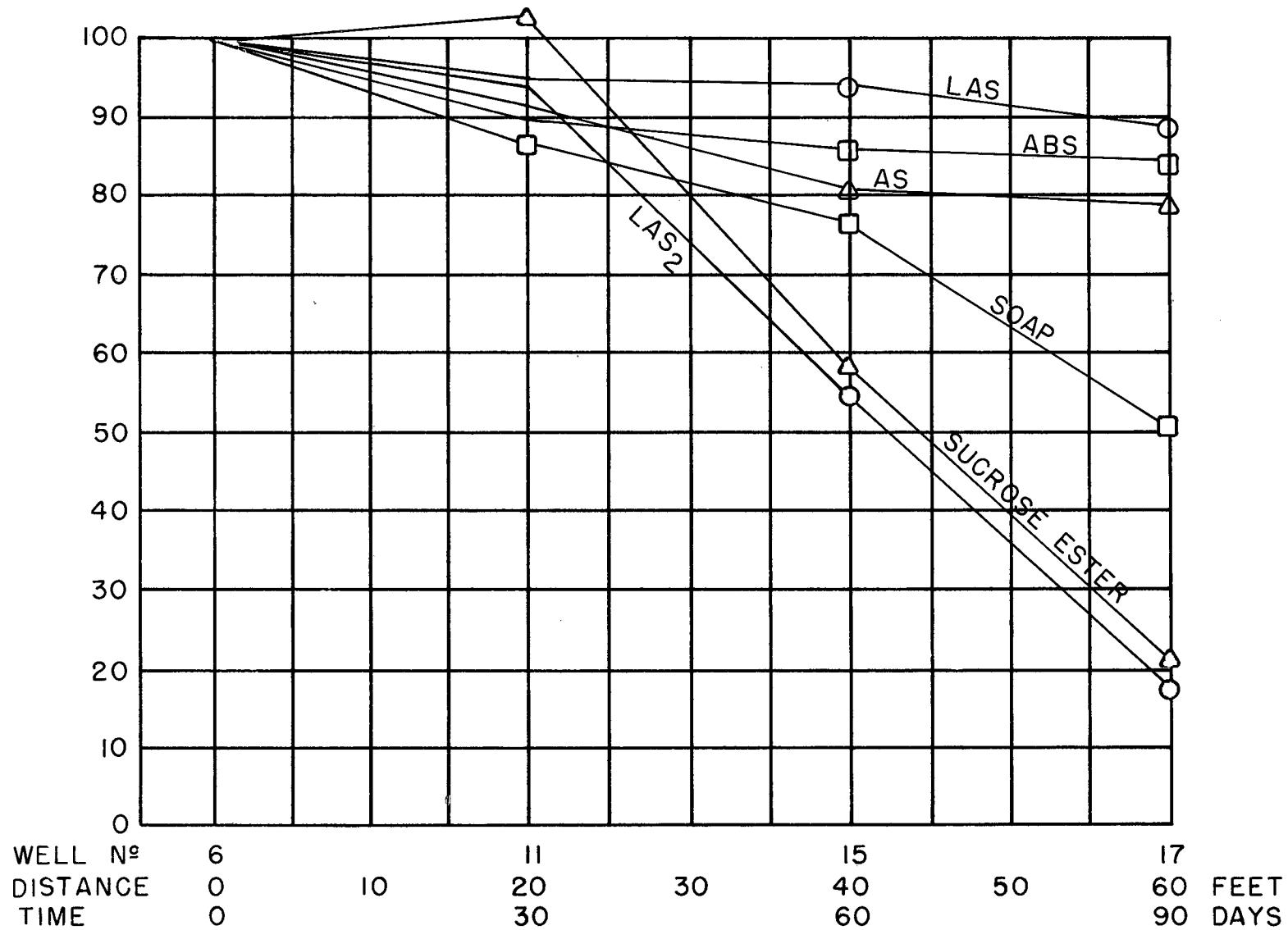

6-24

FIG. 6-9

Average Values

ABS	0.25%/ft.	0.17%/day	0.16 mg/l/ft.
LAS ₁	0.18	0.12	0.11
AS	0.34	0.23	0.21
Soap	0.80	0.54	0.56
LAS ₂	1.37	0.92	0.87
Sucrose Ester	1.29	0.87	0.79

Compensating for dilutional effects, based upon reductions in chloride concentrations, resulted in net ammonia reductions of:

Average Values

ABS	Dilution Values Exceeded Ammonia Reduction Rates	
LAS ₁		
AS	0.01%/ft.	0.01%/day
Soap	0.27	0.18
LAS ₂	0.76	0.51
Sucrose Ester	0.78	0.53

5. Significantly, greater reduction rates for ammonia occurred during the use of the final three surfactants (Soap, LAS₂, and Sucrose Ester).

6. Generally, between the cesspool and well group No. 11, 25 feet downstream from the disposal system, the reduction in free ammonia appeared to proceed at a relatively constant rate. Beyond well group No. 11, the rate of ammonia reduction increased significantly with the use of Soap and continued during the remaining surfactants. The abrupt change in rates at this point is not readily explained but could have been caused by changing water levels which could affect the relationship of the observation well point to the sewage slug. The rates of ammonia reduction through this downstream flow path were:

(Well #11 to #17 40', 60 days)

Average Values

ABS	0.15%/ft.	0.10%/day	0.08 mg/l/ft.
LAS ₁	0.18	0.12	0.10
Soap	1.01	0.68	0.62
LAS ₂	2.02	1.35	1.20
Sucrose Ester	1.95	1.31	1.23

Compensation for dilution, based upon chloride reductions in this flow region, resulted in net free ammonia reduction rates of:

Average Values

ABS	Dilution Values Exceeded Ammonia Reduction Rates	
LAS ₁	Dilution Values Exceeded Ammonia Reduction Rates	
AS	Dilution Values Exceeded Ammonia Reduction Rates	
Soap	0.48%/ft.	0.32%/day
LAS ₂	1.41	0.94
Sucrose Ester	1.44	0.97

7. During the use of the first three surfactants (ABS, LAS₁, AS) there was relatively little conversion of ammonia to other nitrogenous compounds indicating that reduction of free ammonia was due to adsorption and dilution rather than biological activity.

8. Relatively large amounts of ammonia still persisted at the last observation well group, 65 feet downstream from the disposal system.

LONG ISLAND GROUND WATER POLLUTION STUDY
 NITROGEN CYCLE VERSUS TRAVEL TIME
 ABS IN USE (2/12/1963 - 6/1/1963)
 SITE N° 2 - WEST BABYLON, SUFFOLK COUNTY, N. Y.

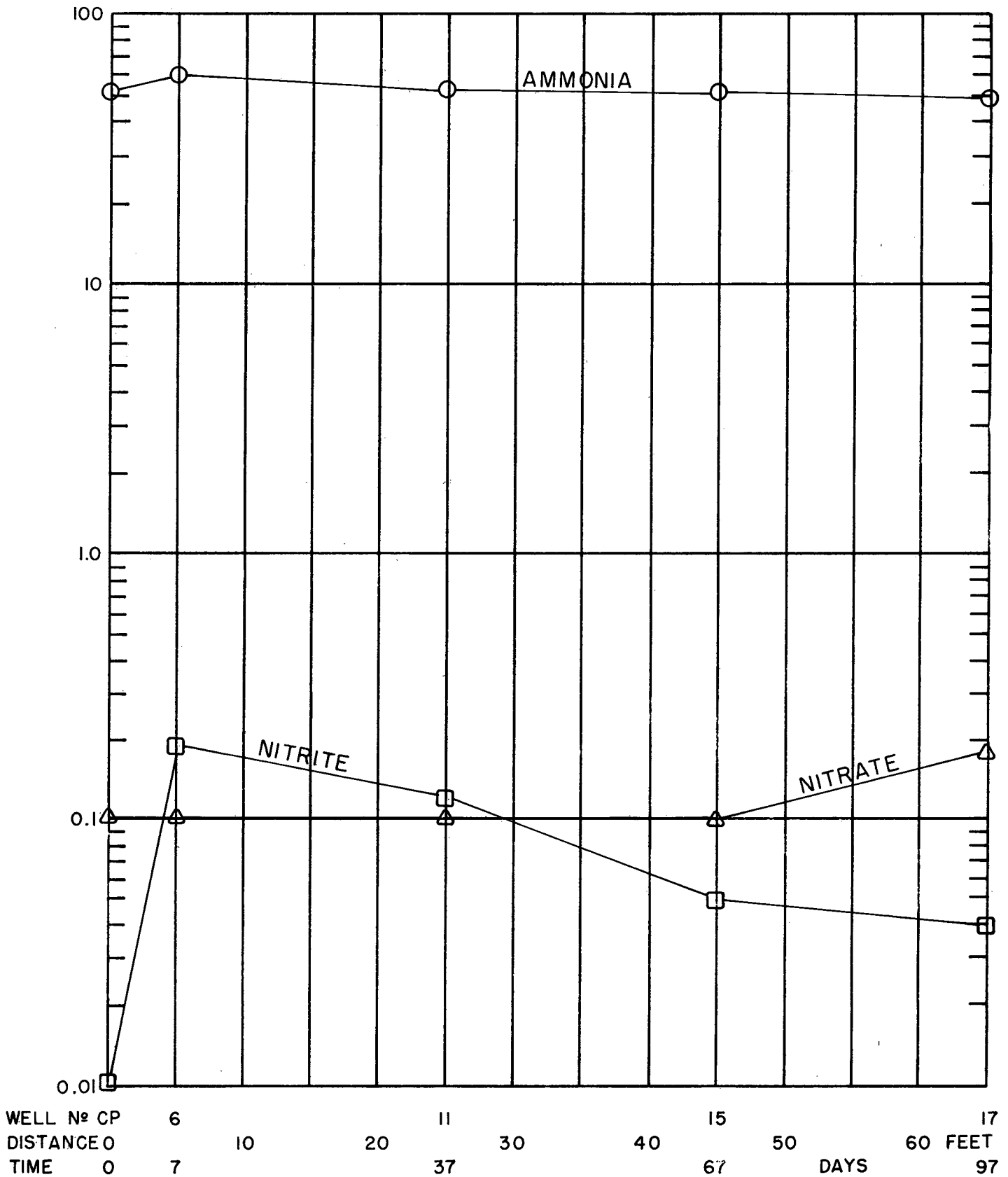

LONG ISLAND GROUND WATER POLLUTION STUDY
 NITROGEN CYCLE VERSUS TRAVEL TIME
 LAS IN USE (6/1/1963 - 4/22/1964)
 SITE Nº 2 - WEST BABYLON, SUFFOLK COUNTY, N. Y.

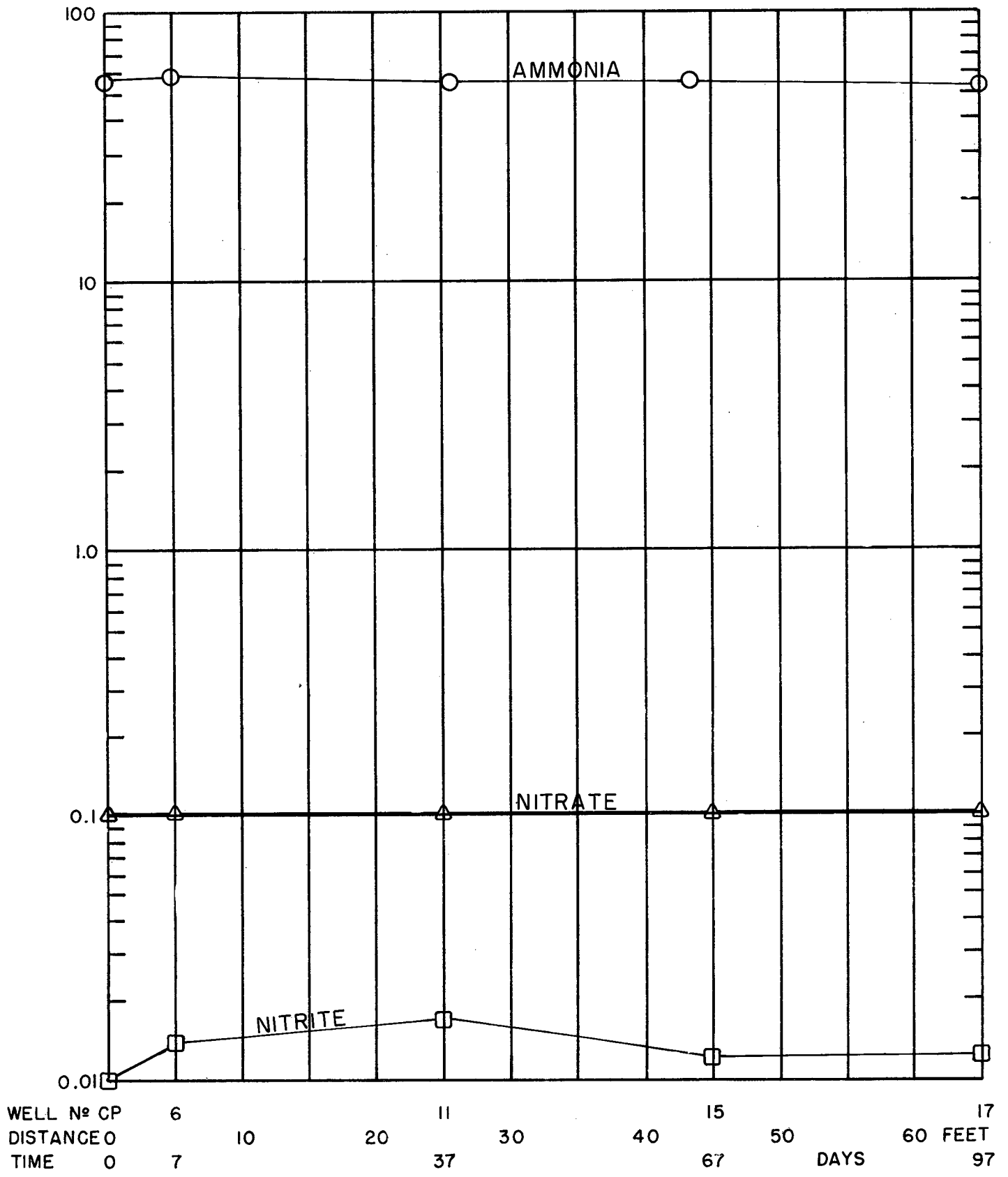

LONG ISLAND GROUND WATER POLLUTION STUDY
 NITROGEN CYCLE VERSUS TRAVEL TIME
 AS IN USE (4/22/1964-12/7/1964)
 SITE N° 2 - WEST BABYLON, SUFFOLK COUNTY, N. Y.

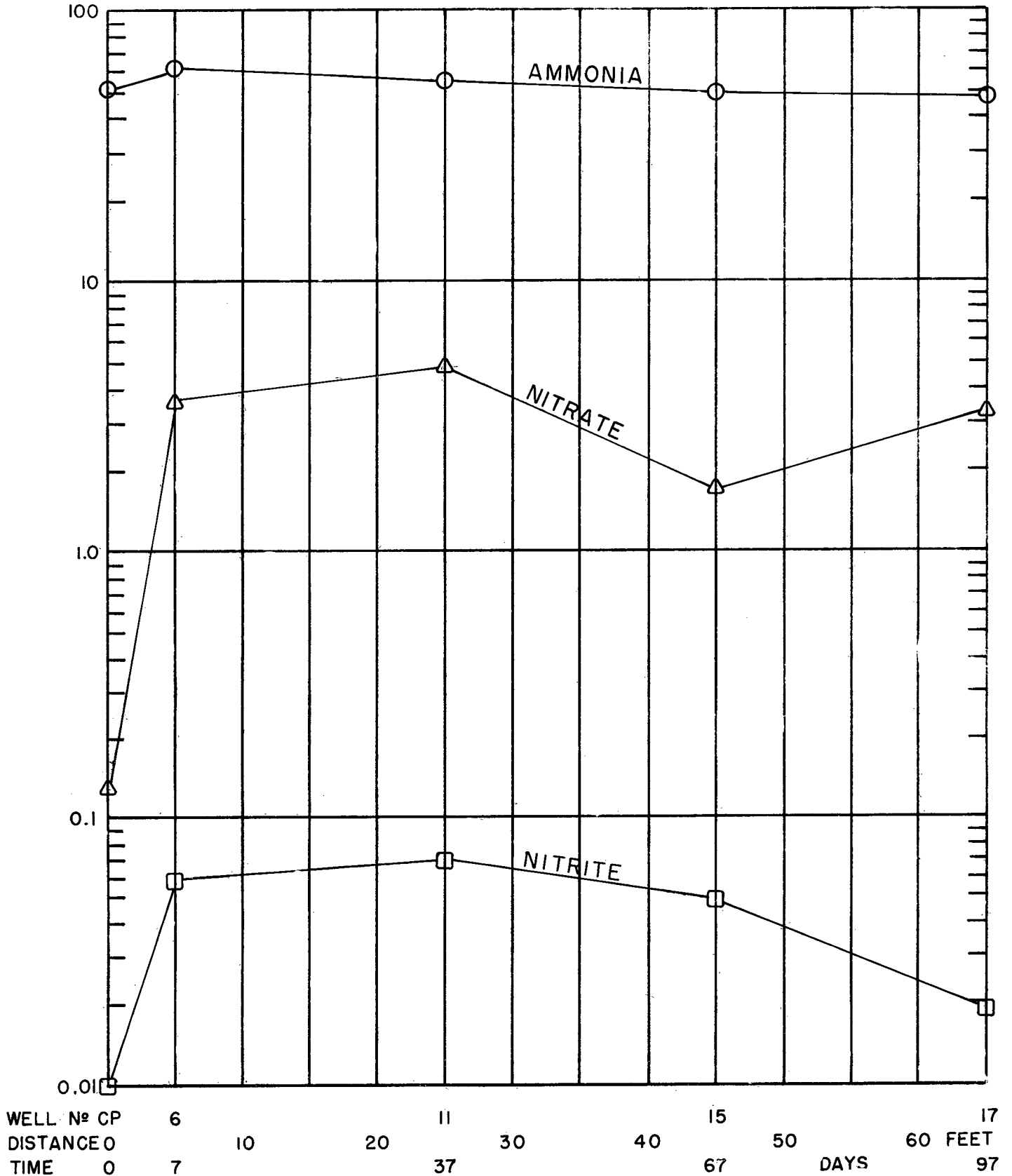
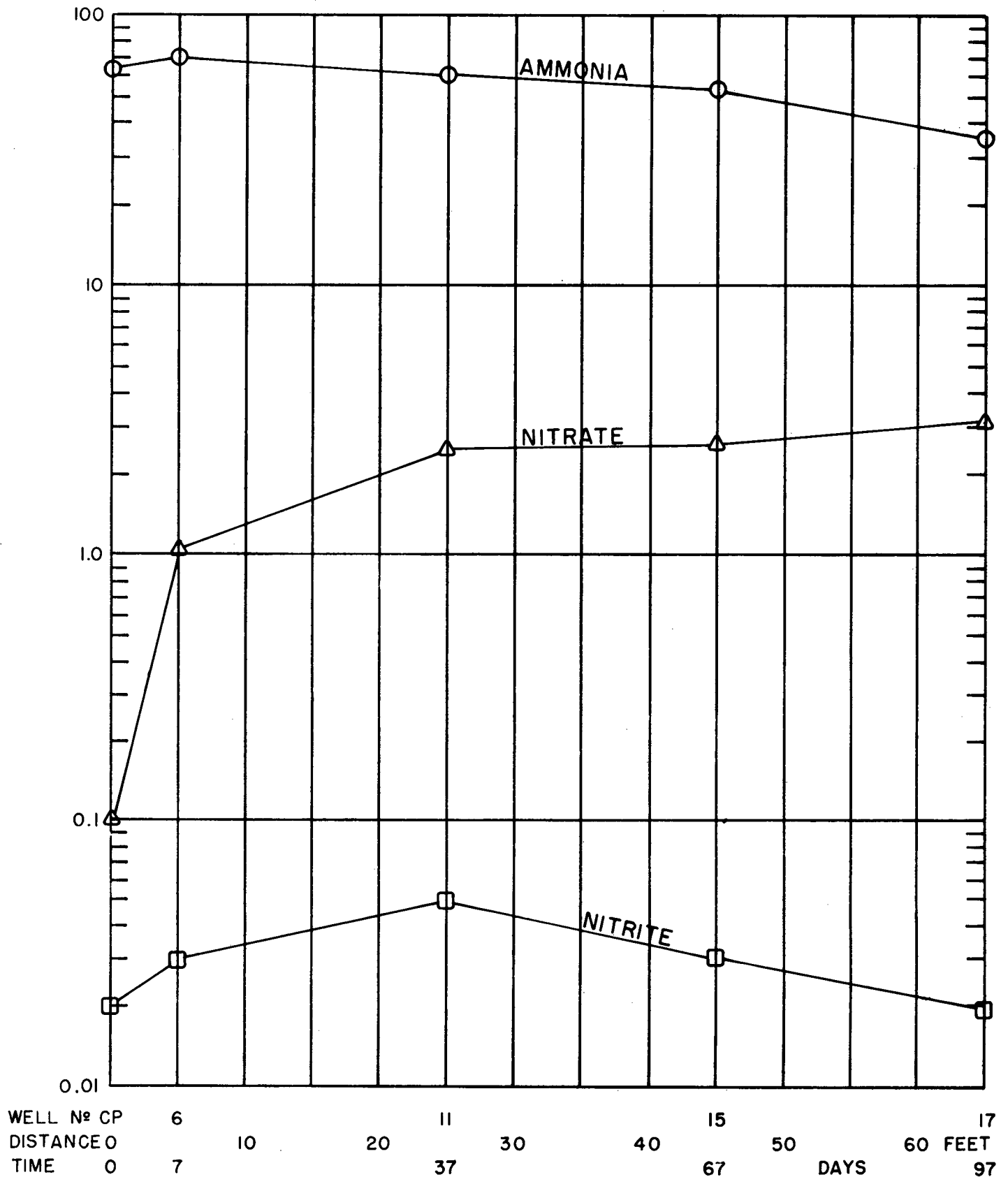
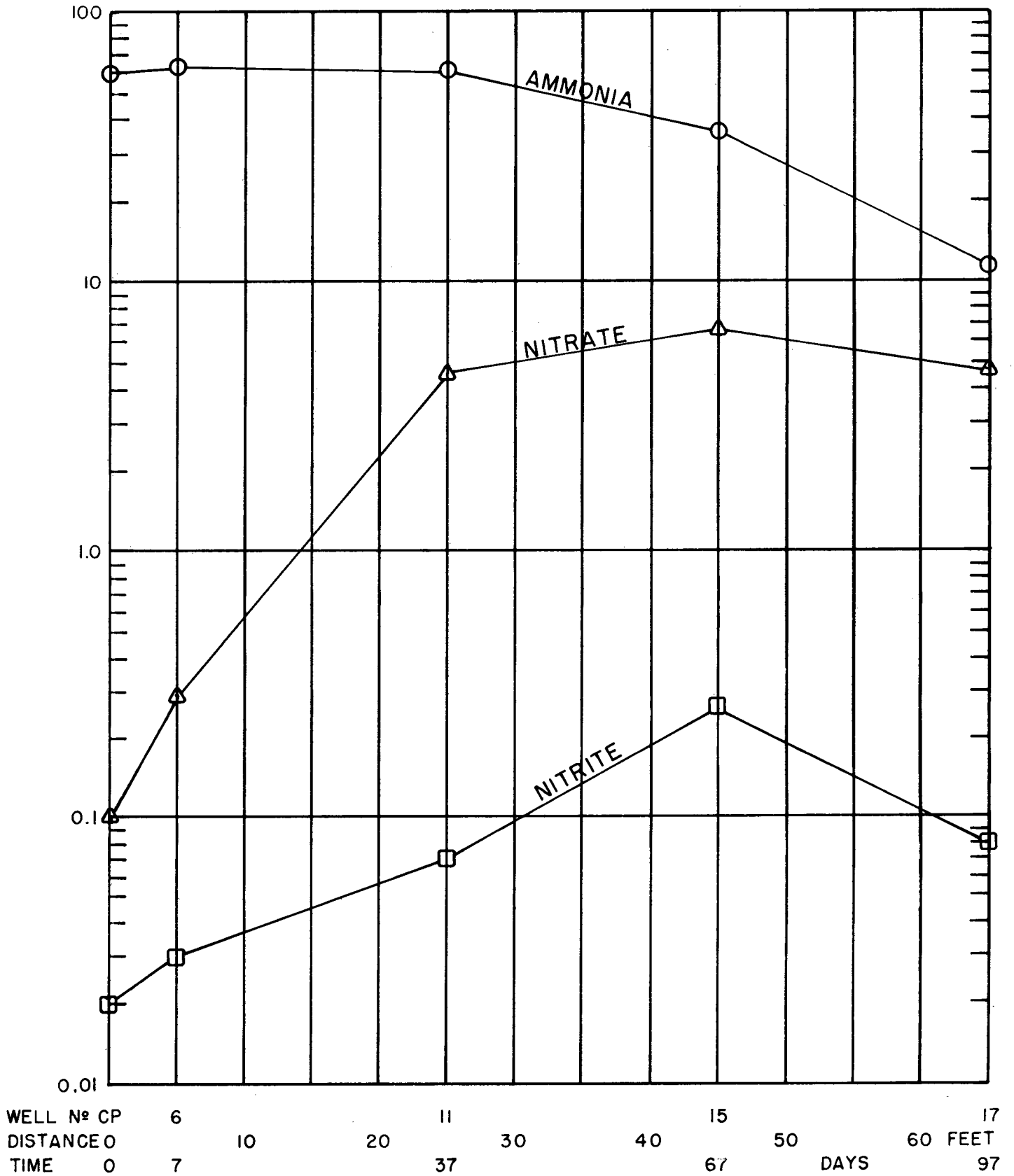

FIG. 6-13

LONG ISLAND GROUND WATER POLLUTION STUDY
 NITROGEN CYCLE VERSUS TRAVEL TIME
 SOAP IN USE (12/7/1964 - 8/24/1965)
 SITE N^o 2 - WEST BABYLON, SUFFOLK COUNTY, N. Y.



LONG ISLAND GROUND WATER POLLUTION STUDY
 NITROGEN CYCLE VERSUS TRAVEL TIME
 LAS IN USE (8/24/1965-10/22/1966)
 SITE N° 2 - WEST BABYLON, SUFFOLK COUNTY, N. Y.



LONG ISLAND GROUND WATER POLLUTION STUDY
 NITROGEN CYCLE VERSUS TRAVEL TIME
 SUCROSE ESTER IN USE (10/22/1966-3/14/1966)
 SITE N° 2 - WEST BABYLON, SUFFOLK COUNTY, N. Y.

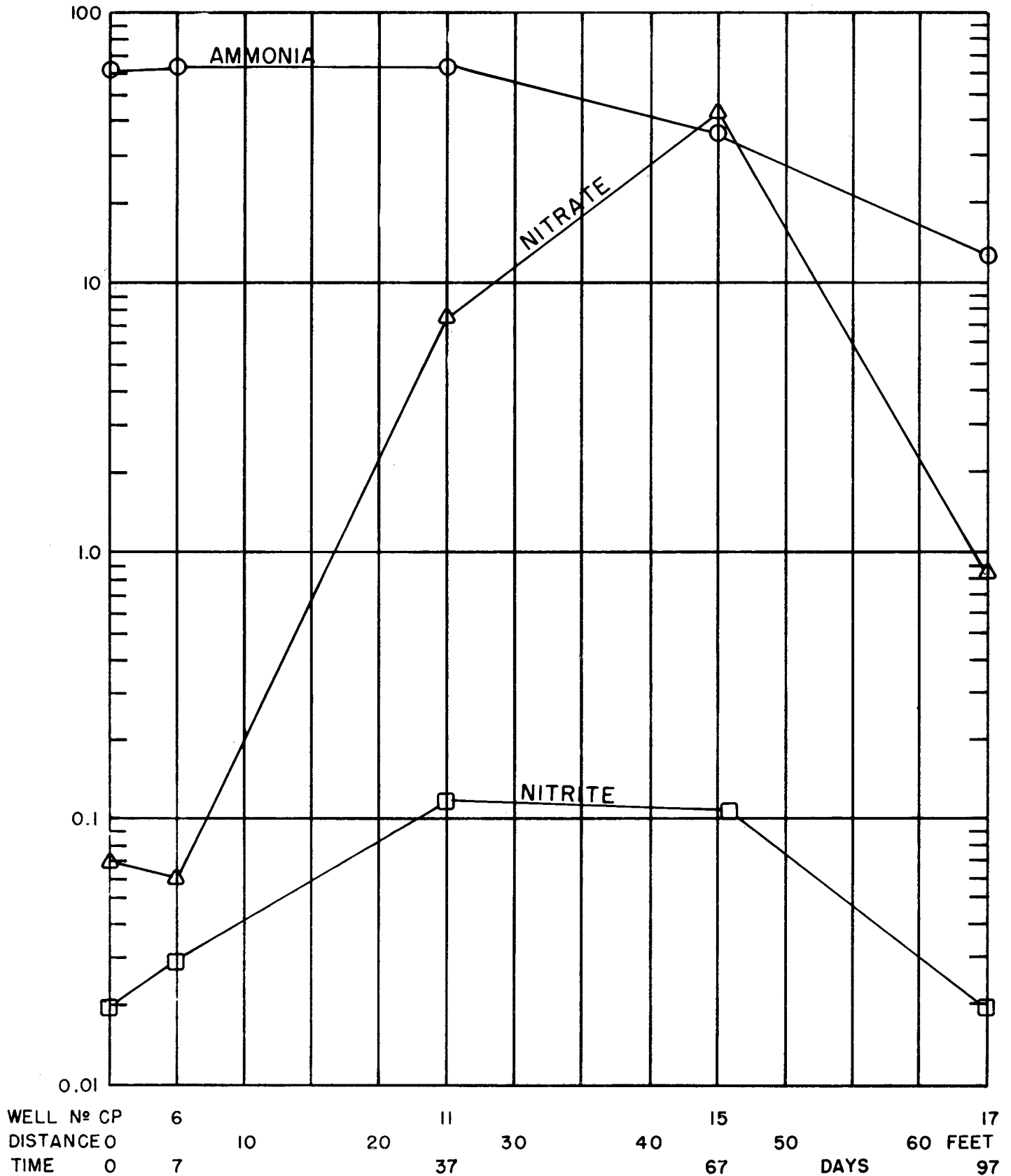

Nitrites

1. Nitrite concentrations (.01 - .02 mg/l) in the cesspool were relatively constant during the use of all surfactants. (Table 6-1) Nitrite levels in the background observation wells was about the same (.04 mg/l).
2. During the use of all surfactants only a small amount of conversion of ammonia to nitrite developed. Complete decomposition of nitrite was assumed due to the presence of large amounts of free ammonia.
3. In most instances, peak nitrite concentrations developed at well group No. 11, 25 feet downstream from the disposal system, except during the use of ABS and LAS₂. With the use of ABS and LAS₂ surfactants, maximum nitrite levels occurred at well groups No. 6 and No. 15 being 5 feet and 45 feet downstream from the cesspool, respectively. (Table 6-1, 2)
4. Although significant reductions in ammonia resulted during the use of Soap, LAS₂ and Sucrose Ester, nitrite levels did not increase to any great extent. (Table 6-1, 2 Figure 6-10 through 15)
5. Beyond the well groups where peak levels developed nitrites reduced through the remainder of the flow path at the following rates:

<u>Average Values</u>				
ABS	Well #6-17	1.32%/ft.	0.88%/day	0.0025 mg/l/ft.
LAS ₁	11-17	1.78	1.20	0.0012
AS	11-17	1.78	1.20	0.0012
Soap	11-17	1.50	1.0	0.0008
LAS ₂	15-17	3.46	2.32	0.009
Sucrose Ester	15-17	2.08	1.40	0.0025

Compensating for dilutional effects, based upon chloride reductions in the saturated zone, resulted in net rates of nitrite reduction of:

<u>Average Values</u>		
ABS	1.01%/ft.	0.67%/day

LAS ₁	1.47%/ft.	0.99%/day
AS	1.45	0.98
Soap	0.97	0.64
LAS ₂	2.85	1.91
Sucrose Ester	1.57	1.06

6. As determined by net reduction rates, factors besides dilution resulted in decreases in nitrite levels through the downstream flow path.

Nitrates

Nitrate concentrations within the disposal system ranged between 0.07 and 0.13 mg/l. (Table 6-1) Background observation wells had average nitrate levels of 2.3 and 4.0 mg/l in the upgradient waste slug and surrounding ground waters, respectively.

2. Constant nitrate concentrations of 0.1 mg/l occurred throughout the downstream sampling wells and within the cesspool during the use of ABS and LAS₁. During the use of the remaining surfactants, (Soap, LAS₂, Sucrose Ester) increased nitrate levels occurred with peak nitrate concentrations being developed at Well No. 15, 45' downstream from the cesspool. Maximum nitrate levels during the use of AS occurred at Well No. 11, 25' from the cesspool. (Table 6-1 Figure 6-10 through 15)

3. Generally, peak nitrate concentrations tended to increase with the use of each succeeding surfactant. Significantly larger average nitrate levels resulted during the use of Sucrose Ester, 42.6 mg/l, than with the other surfactants, 0.1 to 6.5 mg/l.

4. Development of nitrates in the saturated zone appeared to be more associated with reduction characteristics of free ammonia than with the extent and level of nitrite production. Generally, where large reductions in ammonia resulted relatively higher nitrate levels, developed whereas with little ammonia reduction during the use of ABS and LAS₁, nitrates remained at the cesspool level throughout the limits of the flow path studied.

5. The considerable length of time for the advancement of the nitrogen cycle and

low production of nitrites and nitrates was attributed to the low dissolved oxygen content of the downstream ground waters, thus inhibiting activity of nitrifying organisms.

Sulfates

1. Sulfate concentrations in the disposal system varied with the surfactant in use ranging between 8.2 and 65.2 mg/l, except during the use of ABS which had an average sulfate content of 177.0 mg/l. (Table 6-1) All background wells had a relatively high sulfate level in all wells averaging 52.0 mg/l. (Table 4-1)
2. Within the disposal system, sulfate content varied with the use of LAS surfactant on two separate occasions. Average sulfate concentrations of 65.2 mg/l resulted during the first usage of LAS, while levels of only 10.9 occurred the second time LAS was used as the washing compound. (Table 6-1, 2)
3. Generally, sulfates increase in concentration with increased distance downstream and attain maximum levels at either well group No. 11 or 15, being 25-45' downstream from the disposal system, except during the use of ABS. (Figure 6-16)
4. Downstream from the well group exhibiting peak sulfate concentrations sulfates generally reduced through the remaining portions of the saturated zone at the following rates:

		<u>Average Values</u>		
ABS	Well #6-17	0.81%/ft.	0.54%/day	0.58 mg/l/ft.
LAS ₁	15-17	1.41	0.95	1.44
AS	11-17	0.94	0.63	0.97
Soap	Sulfate levels increased to last test well			
LAS ₂	15-17	1.74	1.16	1.75
Sucrose Ester	15-17	0.84	0.56	1.05

Compensating for dilution, based upon reductions in chloride concentration, resulted in net rates of sulfate reduction of:

LONG ISLAND GROUND WATER POLLUTION STUDY
 REDUCTION VERSUS TRAVEL TIME
 SULFATES (2/12/1963-3/14/1966)
 SITE N° 2 - WEST BABYLON, SUFFOLK COUNTY, N. Y.

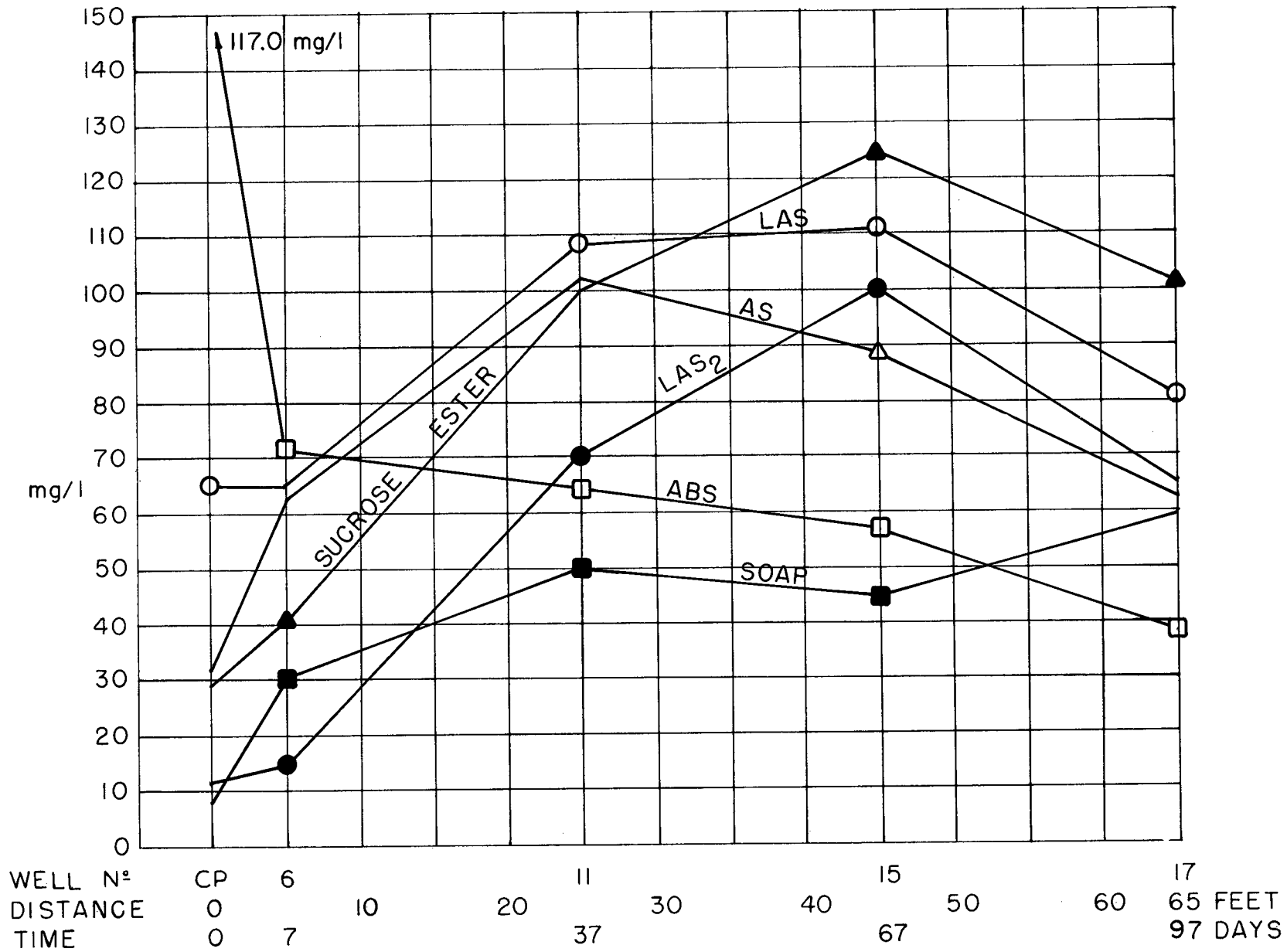

6-36

FIG. 6-16

	<u>Average Values</u>	
ABS	0.50%/ft.	0.33%/day
LAS ₁	1.10	0.74
AS	0.61	0.41
Soap	---	---
LAS ₂	1.13	0.75
Sucrose Ester	0.33	0.22

5. Net rates of sulfate reduction indicated that factors other than dilution aided in the reduction of sulfates in the saturated soil zone.

6. Sulfate concentrations of 37.3 to 104.0 mg/l still persisted at the final downstream from the disposal system.

Phosphates

1. In most cases, the ortho and total phosphate concentrations within the disposal system and at downstream wells was about equal. Total phosphate levels in the cesspool averaged between 47.5 and 122.0 mg/l depending upon the surfactant being used.

(Table 6-1) Upstream observation wells indicated extremely low total phosphate content averaging 0.04 mg/l in all wells, even those wells exhibiting the up-gradient sewage slug. (Table 4-1)

2. Generally, the phosphate content in the disposal system was relatively consistent with the phosphate portion of the surfactant and water usage, except during the use of Sucrose Ester. The increased phosphate concentration in the cesspool during the use of Sucrose Ester was due to the installation of an automatic dishwasher and use of a high phosphate detergent.

3. Total phosphates decreased with varying rates through the downstream wells but maintained an overall decreasing trend. (Table 6-1, 2 Figures 6-17, 18 27 thru 38) Between the cesspool and well group No. 11, 25' travel distance, phosphates had a generally constant rate of reduction. Further travel, Wells No. 11 to 15, resulted in increased reduction rates for a distance of 20', then followed by a very gradual

LONG ISLAND GROUND WATER POLLUTION STUDY
 REDUCTION VERSUS TRAVEL TIME
 TOTAL PHOSPHATES (2/12/1963-3/14/1966)
 SITE N° 2 - WEST BABYLON, SUFFOLK COUNTY, N. Y.

6-38

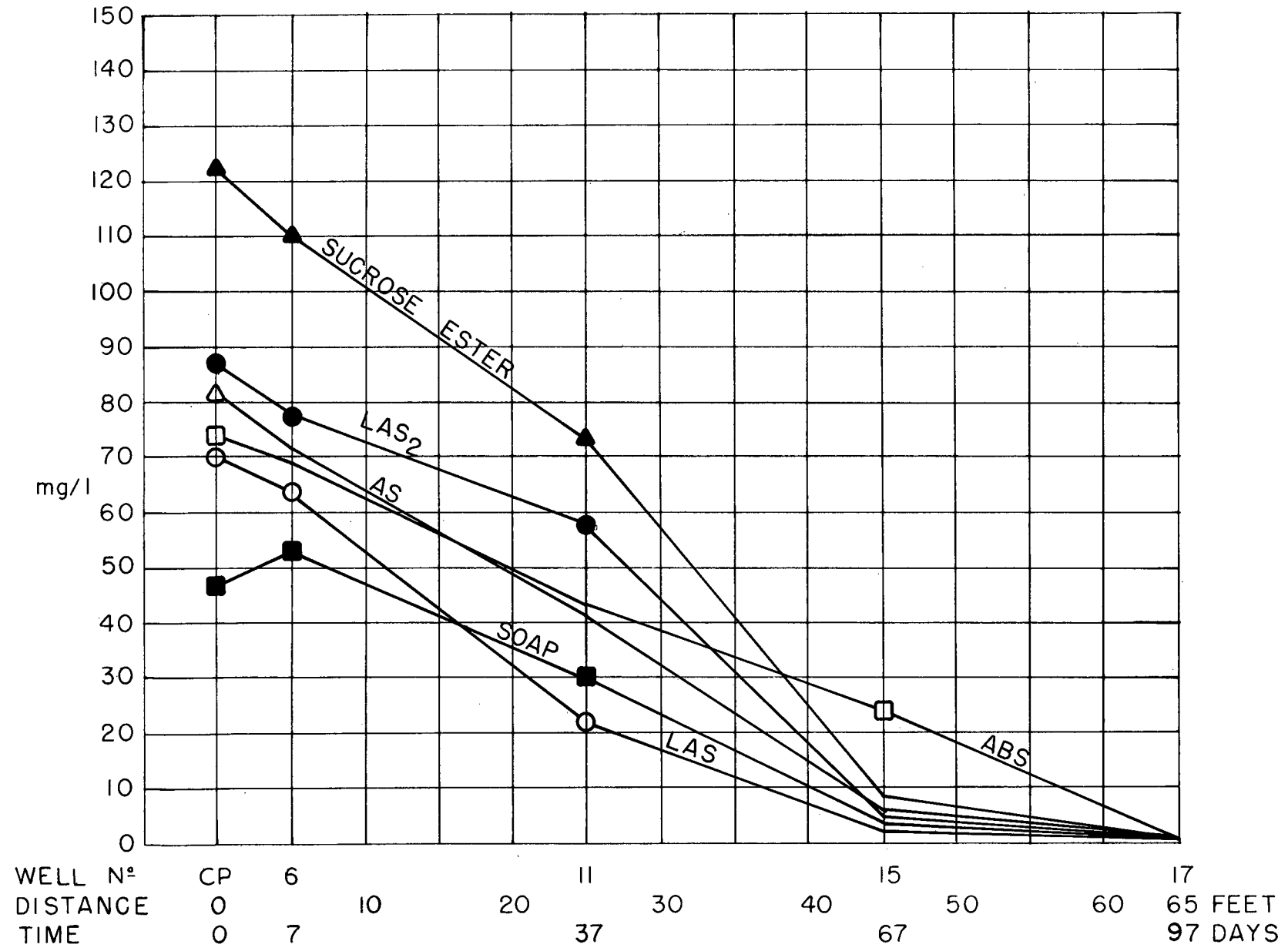
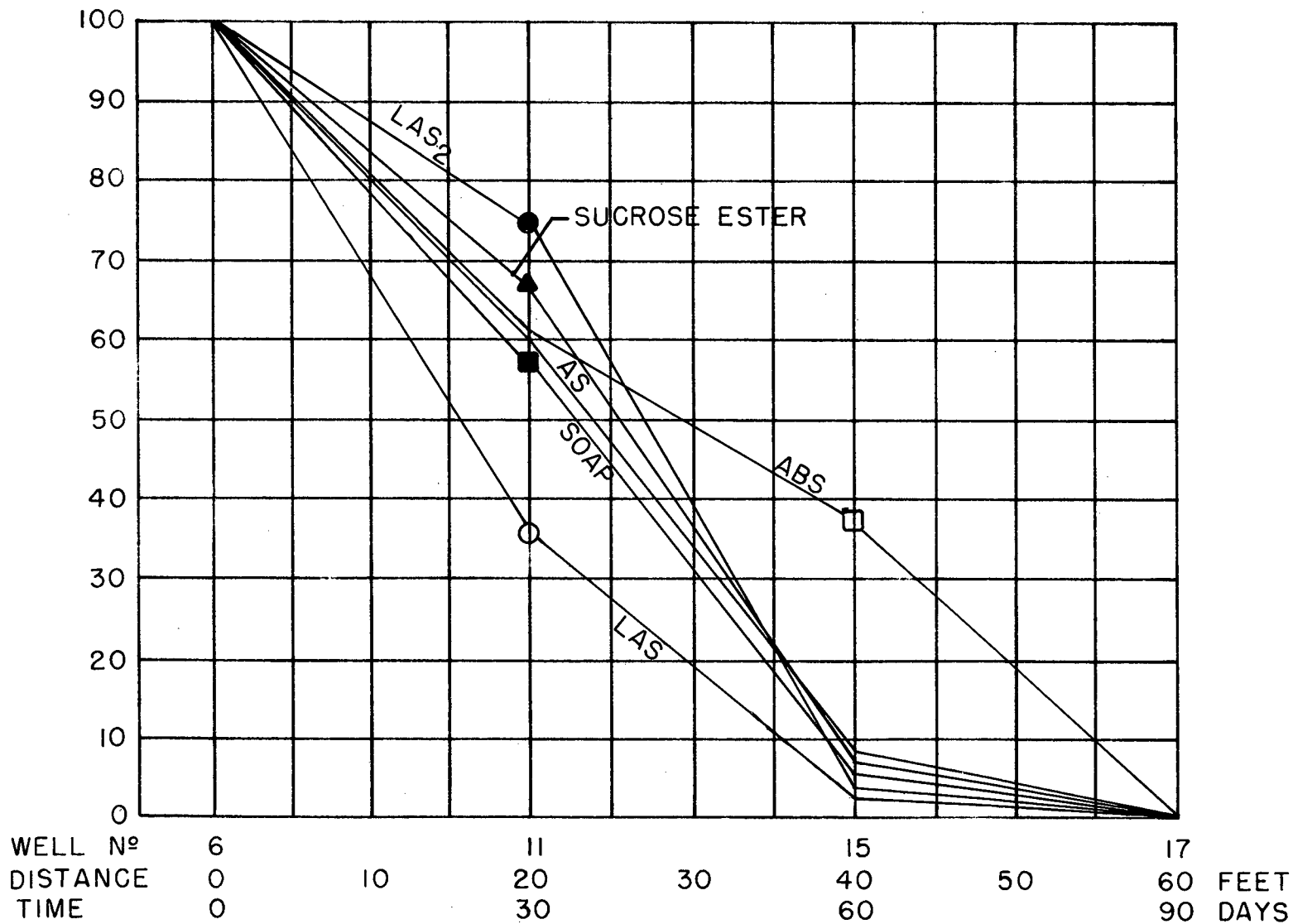

FIG. 6-17

LONG ISLAND GROUND WATER POLLUTION STUDY
 PERCENT REMAINING OF FIRST WELL CONCENTRATION
 TOTAL PHOSPHATES (2/12/1963-3/14/1966)
 SITE Nº 2 - WEST BABYLON, SUFFOLK COUNTY, N. Y.



6-39

FIG. 6-18

decrease out to the final well group No. 17.

4. At the last observation well group, 65' downstream from the cesspool, greater than a 98.5 percent reduction in total phosphate levels resulted during the use of all surfactants. Extremely low phosphate levels existed at the final well group ranging between 0.03 and 0.6 mg/l approximately equal to the observed levels in the upstream test wells measuring the background waters.

5. Accurate overall and net rates of total phosphate reduction could not be established due to incremental change in the reduction rates at each well group.

Coliform Organisms

1. Log average coliform concentrations (MPN's) in the disposal system varied with the use of each surfactant ranging from a low population of 3.33×10^5 per 100 ml during the use of AS to a maximum density of 10.16×10^6 per 100 ml with the use of Soap. (Table 6-1) Upstream observation wells indicated a relatively uniform log average coliform density of 45 per 100 ml but with peak numbers exceeding 24,000 per 100 ml. (Table 4-1)

2. The persistence of coliform organisms in ground water travel was exhibited by the high coliform counts observed in all the upstream sampling wells. Site No. 2 was located in a densely populated unsewered area; and therefore, subject to up-gradient pollutional sources.

3. Significant reductions in coliform numbers, 94.5 to 98.8 percent resulted in travel from the cesspool to first well group, except with the use of ABS and AS surfactants. With the use of AS only, a 68.5 percent reduction occurred in this initial travel distance; while an increase of 68.2 percent in coliform density was observed during the use of ABS (Table 6-2)

4. Travel through the downstream flow path, first to last well groups, resulted in coliform reductions but at a generally decreasing rate with each subsequent downstream well group. (Figure 6-19, 20 27 thru 38) Greater than a 99.4 percent reduction of coliform populations resulted in this downstream travel distance.

LONG ISLAND GROUND WATER POLLUTION STUDY
 REDUCTION VERSUS TRAVEL TIME
 LOG AVERAGE COLIFORM (10/15/1962-11/30/1964)
 SITE N° 2 - WEST BABYLON, SUFFOLK COUNTY, N. Y.

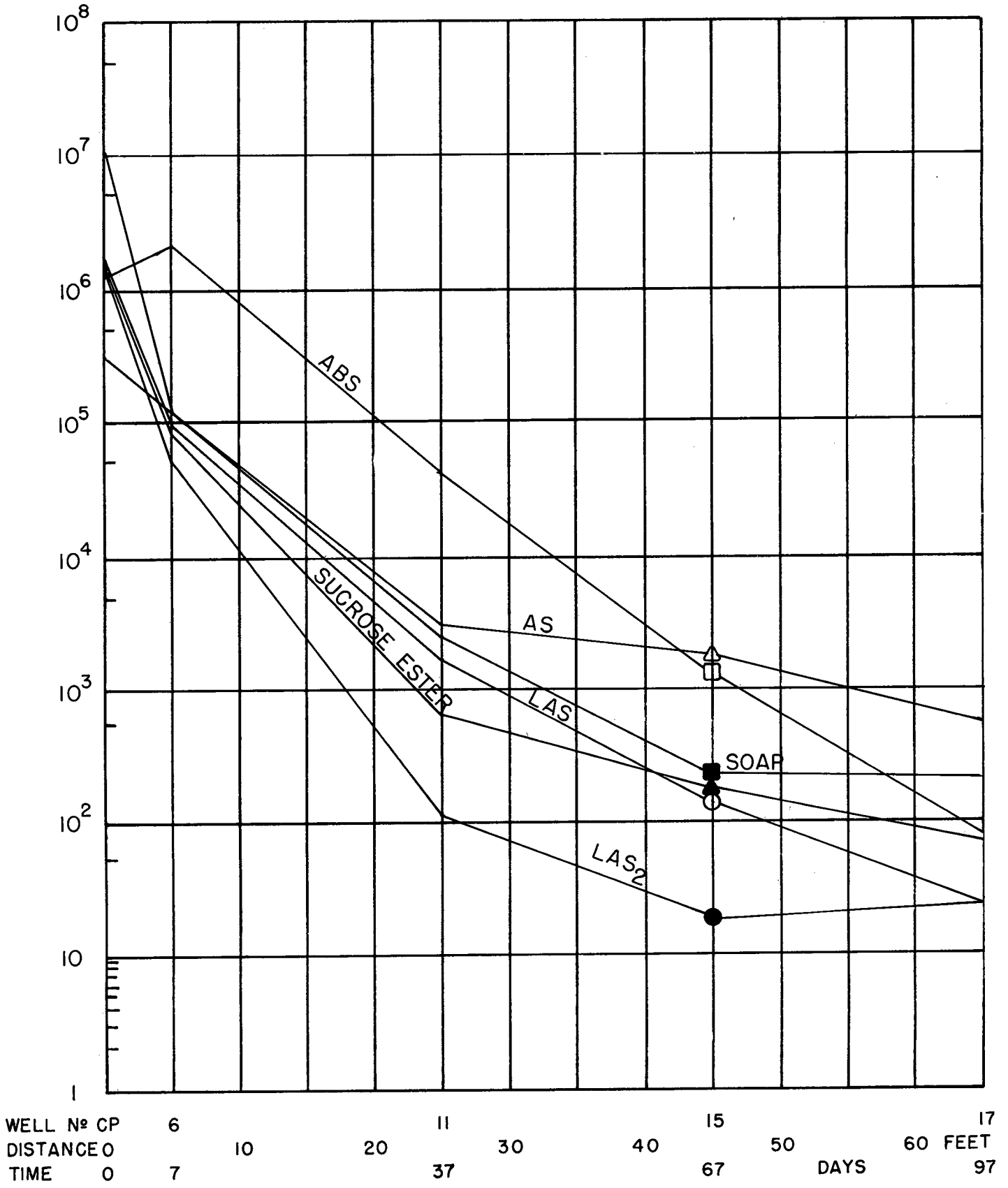

LONG ISLAND GROUND WATER POLLUTION STUDY
 PERCENT REMAINING OF FIRST WELL CONCENTRATION
 LOG AVERAGE COLIFORM (2/12/1963 - 3/14/1966)
 SITE Nº 2 - WEST BABYLON, SUFFOLK COUNTY, N. Y.

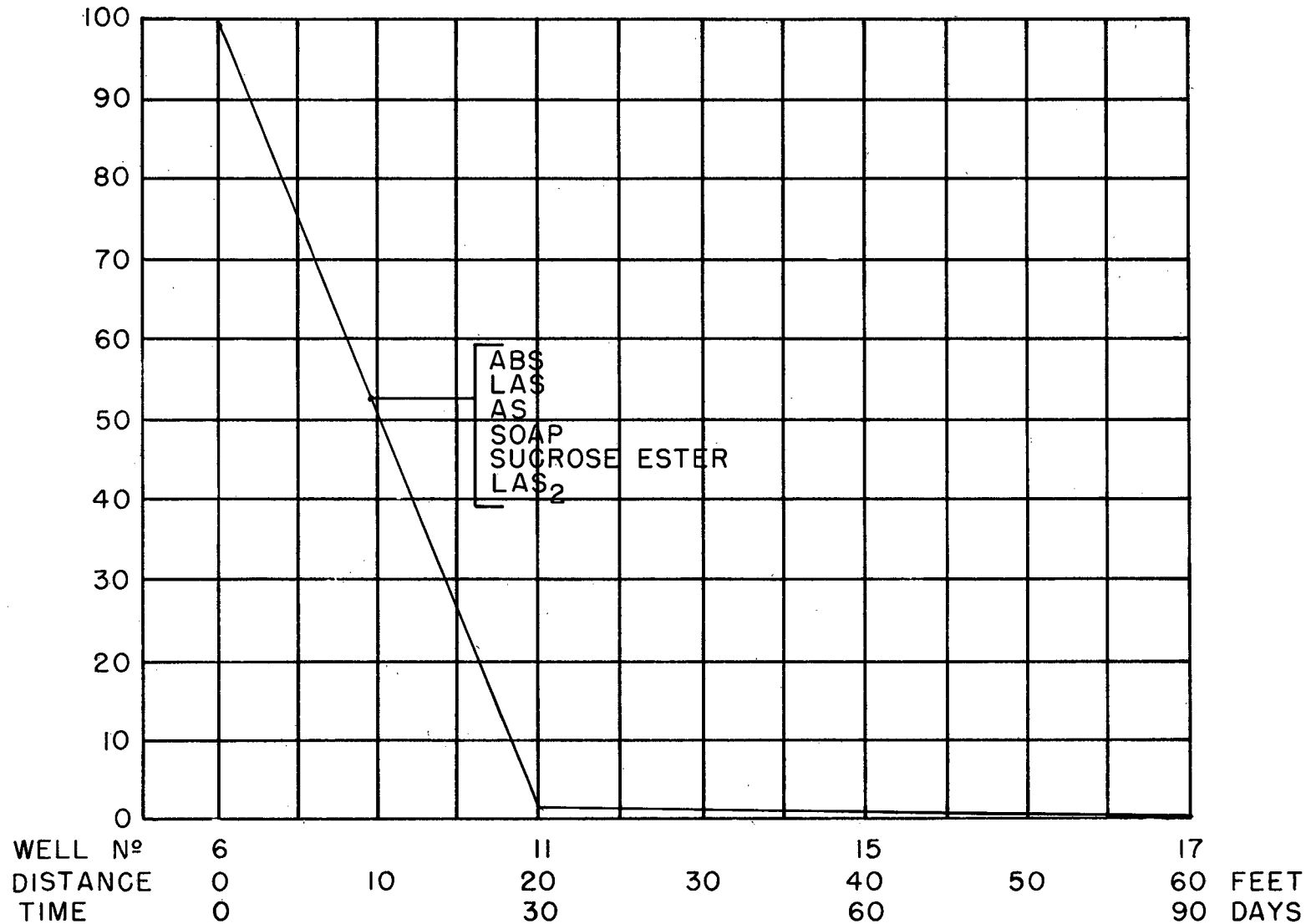

6-42

FIG. 6-20

5. Those wells not showing evidence of sewage contamination were also relatively free of coliform organisms.
6. Log average coliform numbers and total phosphates appeared to have similar reduction characteristics and magnitudes in movement through the downstream flow path. Overall reductions in total phosphate levels and coliform organisms of greater than 99 percent resulted for both sewage constituents.
7. There did not appear to be a relationship between the reduction in MBAS during the use of the various surfactants and bacterial populations present at downstream sampling locations.
8. Travel through 65 feet of saturated sands was not sufficient protection to decrease coliform numbers to a level which would meet bacterial standards for a potable water source. At the final well group No. 16, 65' downstream from the cesspool, log average coliform densities of between 24 and 640 per 100 ml still existed.

Alkalinity

1. Alkalinity concentrations in the disposal system varied with the use of each surfactant and ranged between 293 and 385 mg/l as Ca CO₃. (Table 6-1) Upstream observation wells had an average alkalinity level of 72 and 23 mg/l as CaCO₃ measured in the wells showing presence of sewage contamination and peripheral ground waters, respectively,
2. During the use of all surfactants, alkalinity concentrations increased in travel between the cesspool and first downstream well group. Increases in alkalinity through this initial flow path ranged between 1.5 and 28.8 percent.
3. Alkalinity levels decreased with movement of the waste slug in the downstream saturated soil zone.
4. The rate of alkalinity reduction between the first well group and Well No. 11, 25' downstream from the cesspool, was relatively constant during the use of all surfactants. Beyond well group No. 11, use of the initial three surfactants

(ABS, LAS₁ and AS) resulted in constant alkalinity levels at all subsequent downstream wells. With the use of the final three surfactants, (Soap, LAS₂ and Sucrose Ester) alkalinity reduction rates substantially increased beyond well group No. 11. (Table 6-2 Figure 6-21, 22; 27 through 38)

5. Rates of alkalinity reduction through the downstream flow path was as follows:

	<u>Well #6-#11</u>			<u>Well #11-#17</u>		
ABS	0.34%/ft.	0.23%/day	1.30 mg/l/ft.	0.12%/ft.	0.08%/day	0.42 mg/l/ft.
LAS ₁	0.51	0.34	1.75	0.016	0.011	0.05
AS	0.47	0.31	1.80	0.09	0.06	0.30
Soap	0.71	0.47	3.24	1.66*	1.11*	6.30*
LAS ₂	0.45	0.30	1.90	1.72	1.15	6.90
Sucrose Ester	0.45	0.30	1.90	1.63	1.09	6.15

* Well #15-#17 (20' travel)

Compensating for dilution, based upon reductions in chloride concentrations, indicated net alkalinity reduction rates of:

	<u>Well #6-#11</u>		<u>Well #11-#17</u>	
ABS	0.03%/ft.	0.02%/day	Dilution Rates Exceeded Reduction Rates	
LAS ₁	0.20	0.13	Dilution Rates Exceeded Reduction Rates	
AS	0.14	0.09	Dilution Rates Exceeded Reduction Rates	
Soap	0.18	0.11	1.13%/ft.*	0.75%/day*
LAS	Dilution Rates Exceeded Reduction Rates		1.11	0.74
Sucrose Ester	Dilution Rates Exceeded Reduction Rates		1.12	0.75

* Well #15-#17 (20' travel)

6. Movement of the waste through the lower portions of the flow path, wells No. 11-17 (40' travel), indicated that net alkalinity reduction rates during use of the first three surfactants (ABS, LAS₁ and AS) were due solely to dilution. Net alkalinity

LONG ISLAND GROUND WATER POLLUTION STUDY
 REDUCTION VERSUS TRAVEL TIME
 ALKALINITY (2/12/1963-3/14/1966)
 SITE Nº 2 - WEST BABYLON, SUFFOLK COUNTY, N. Y.

6-45

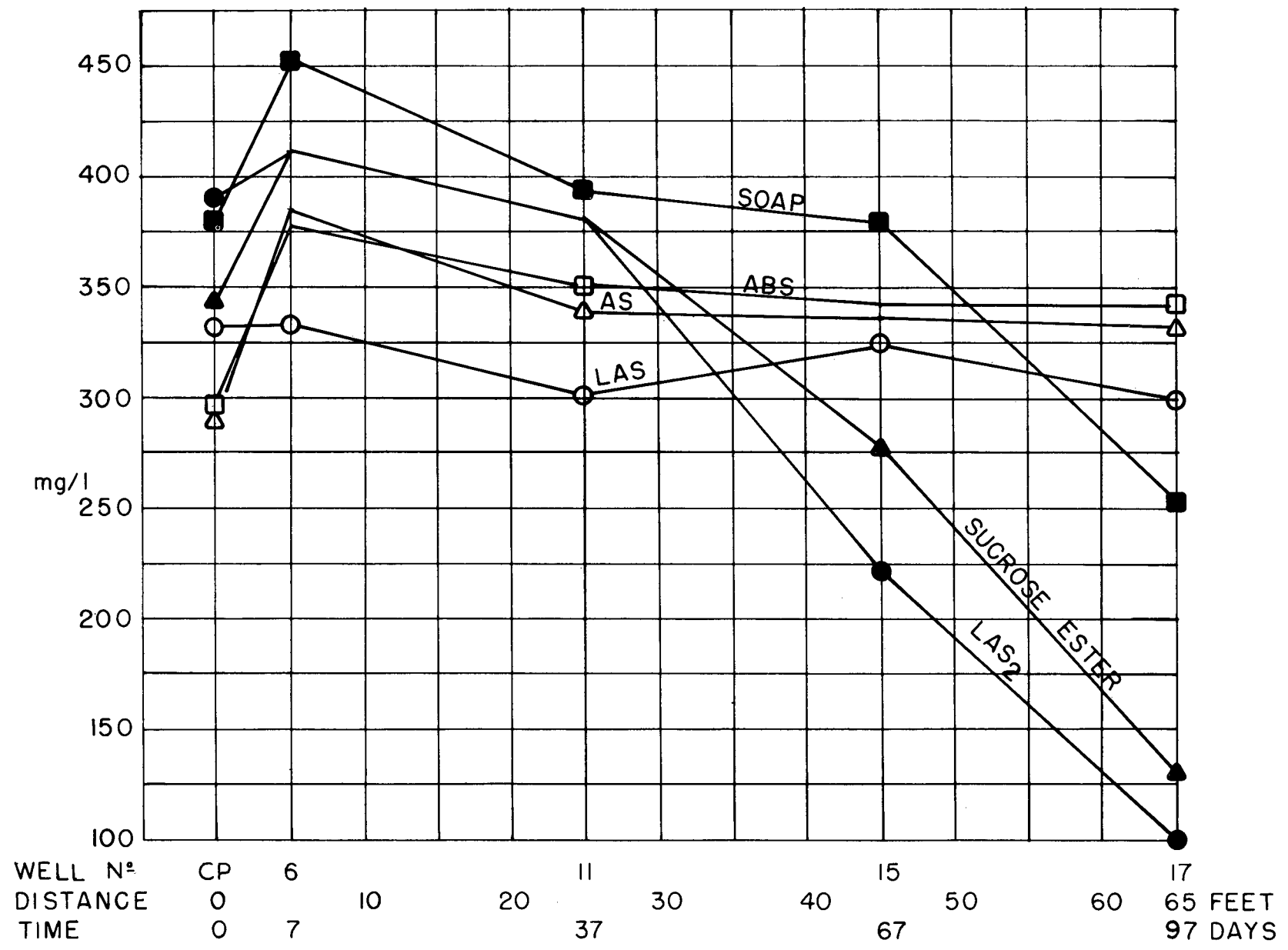
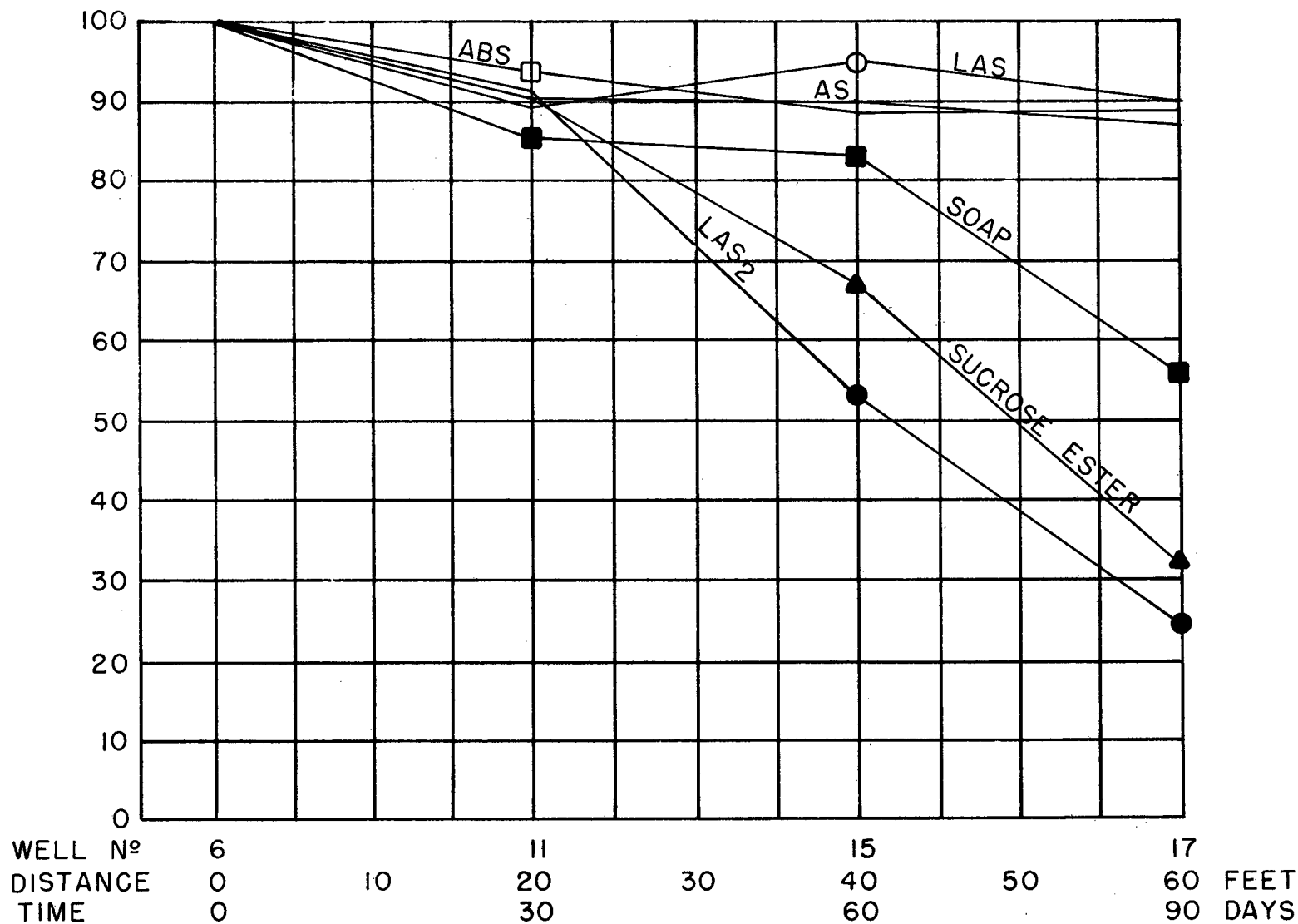

FIG. 6-21

LONG ISLAND GROUND WATER POLLUTION STUDY
 PERCENT REMAINING OF FIRST WELL CONCENTRATION
 ALKALINITY (2/12/1963 - 3/14/1966)
 SITE N° 2 - WEST BABYLON, SUFFOLK COUNTY, N. Y.



6-16

FIG. 6-22

reductions during the use of the final three formulations (Soap, LAS₂ and Sucrose Ester) resulted from dilution and other factors.

7. Generally, alkalinity levels were higher in background and downstream wells showing the presence of sewage contamination.

Specific Conductance

1. Specific conductivity in the cesspool ranged between 558 and 760 umhos/cm² (Table 6-1). Background wells exhibited relatively high specific conductance averaging 290 and 150 umhos/cm² measured in the upgradient waste slug and surrounding ground waters, respectively.

2. In the disposal system average specific conductivity levels increased during the use of each succeeding surfactant tested.

3. Movement of the sewage slug between the cesspool and first downstream well group resulted in a 5.2 to 10.4 percent increase in specific conductance levels, except during the use of LAS₁. A 3.5 percent decrease in conductivity occurred in the same flow distance during the use of LAS₁. (Table 6-1, 2 Figure 6-23, 24; 6-27 through 38)

4. Reduction characteristics of specific conductance through the downstream saturated soil zone varied with the use of each surfactant. During the use of ABS a 4.6 percent increase in specific conductance resulted in travel between the first and last well groups while reductions in conductance during the remaining surfactants were:

<u>Average Values</u>			
LAS ₁	0.27%.ft.	0.18%/day	1.78 umhos/cm ² /ft.
AS	0.25	0.17	1.92
Soap	0.72	0.48	6.21

5. Reductions in chloride concentration, an indication of dilutional effects, were greater than reductions of specific conductance, except during the use of Soap product.

COD

1. In the disposal system, the chemical oxygen demand, COD, varied with the

LONG ISLAND GROUND WATER POLLUTION STUDY
 REDUCTION VERSUS TRAVEL TIME
 SPECIFIC CONDUCTANCE (2/12/1963-9/24/1965)
 SITE N° 2 - WEST BABYLON, SUFFOLK COUNTY, N. Y.

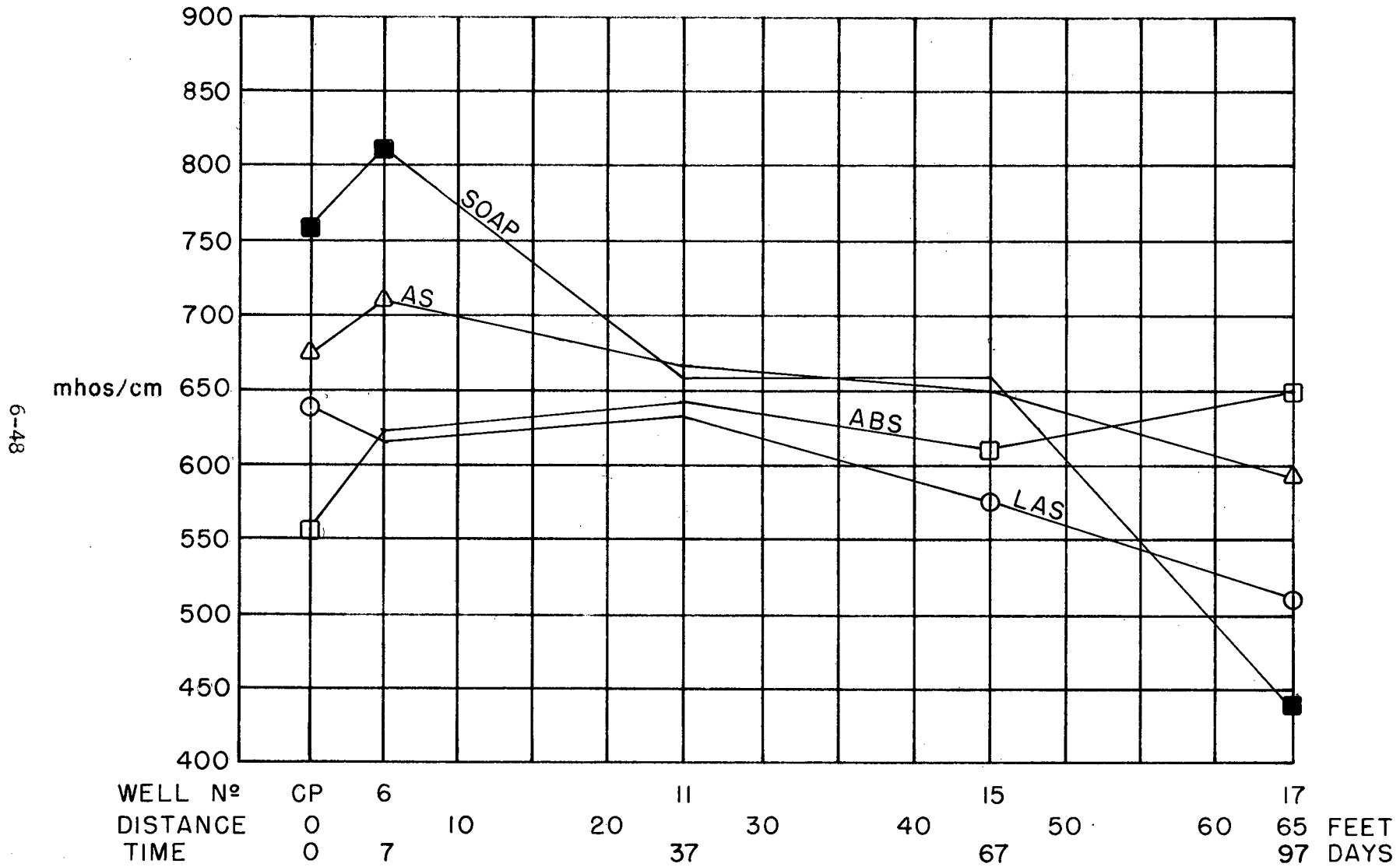
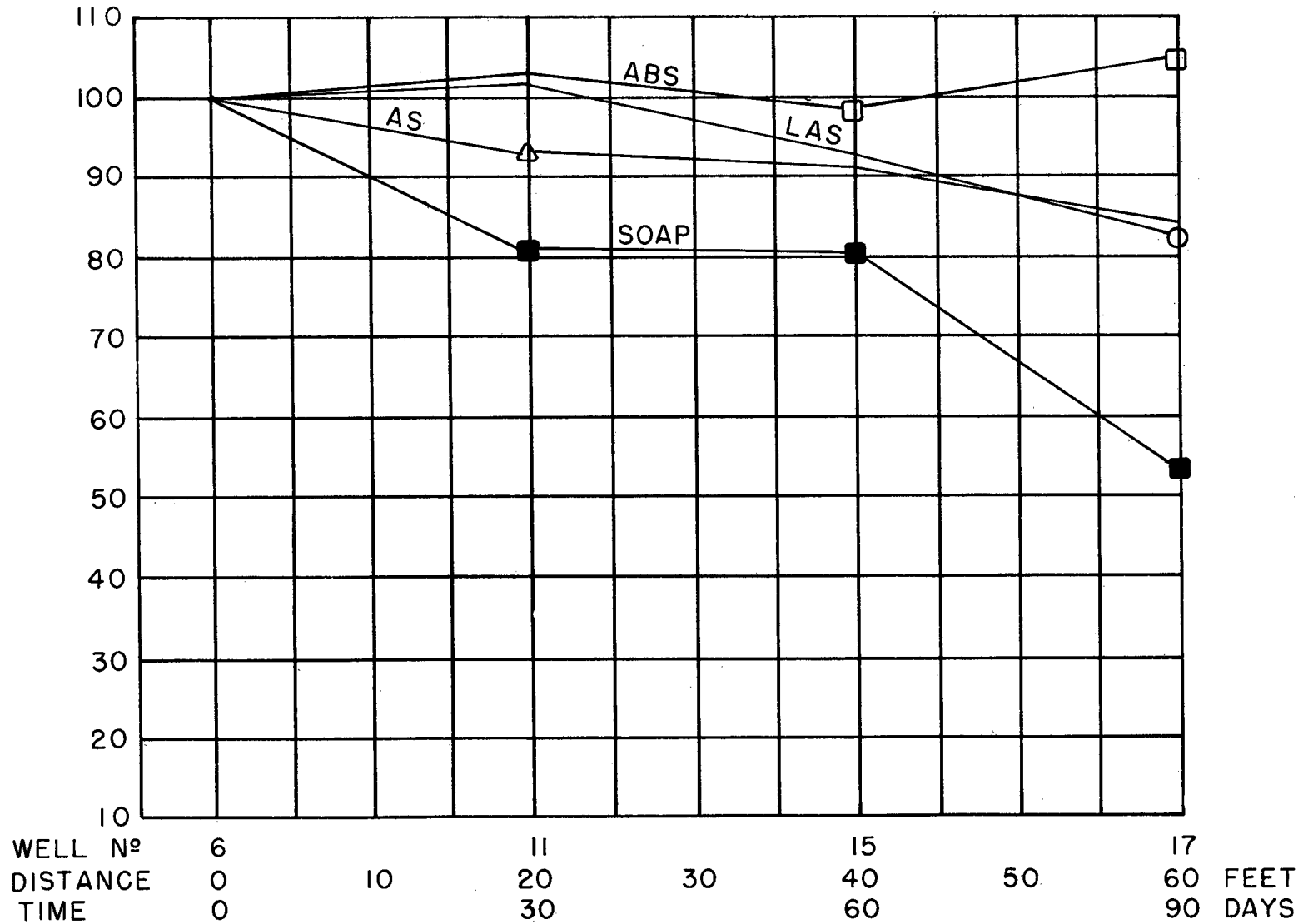

FIG. 6-23

LONG ISLAND GROUND WATER POLLUTION STUDY
 PERCENT REMAINING OF FIRST WELL CONCENTRATION
 SPECIFIC CONDUCTANCE (2/12/1963-8/24/1965)
 SITE N° 2 - WEST BABYLON, SUFFOLK COUNTY, N. Y.



6-49

FIG. 6-24

surfactant being used ranging between 142 and 236 mg/l. (Table 6-1) Background observation wells had average COD concentrations of 19.2 and 7.3 mg/l in those wells, respectively.

2. Movement of the sewage slug between the disposal system and first downstream well group, 5' travel distance, resulted in significant COD reductions except during the use of ABS surfactant. (Table 6-1, 2) COD reduction rates in this initial travel path were:

<u>Average Values</u>			
ABS	3.9%	0.78%/ft.	1.80 mg/l/ft.
LAS ₁	22.6	4.51	6.40
LAS ₂	55.0	11.0	20.2
Sucrose Ester	32.6	6.51	15.4

3. Beyond the first downstream well group No. 6 the first two surfactants, ABS and LAS₁, exhibited similar overall reductions, 26.4 and 22.6 percent. Usage of LAS₂ and Sucrose Ester, the final two surfactants, resulted in significantly larger percent reductions in the same travel distance, being 61.5 and 85.2 percent. A pronounced increase in the COD reduction rates between wells No. 11 and 15 accounted for the overall larger percent reductions during LAS₂ and Sucrose Ester usage. (Table 6-1, 2 Figure 6-25 through 38)

4. Between the final two well groups, No. 15 and 17 (20' travel distance), there appeared to be a relatively consistent rate of COD reduction, except during the use of ABS which had a slight increase in COD level. Reduction rates through this limited downstream flow path were:

<u>Average Values</u>			
ABS	slight increase		
LAS ₁	0.87%/ft.	0.58%/day	0.90 mg/l/ft.
LAS ₂	0.90	0.60	0.35
Sucrose Ester	2.12	1.42	0.85

LONG ISLAND GROUND WATER POLLUTION STUDY
 REDUCTION VERSUS TRAVEL TIME
 COD (2/12/1963-3/14/1966)
 SITE N° 2 - WEST BABYLON, SUFFOLK COUNTY, N. Y.

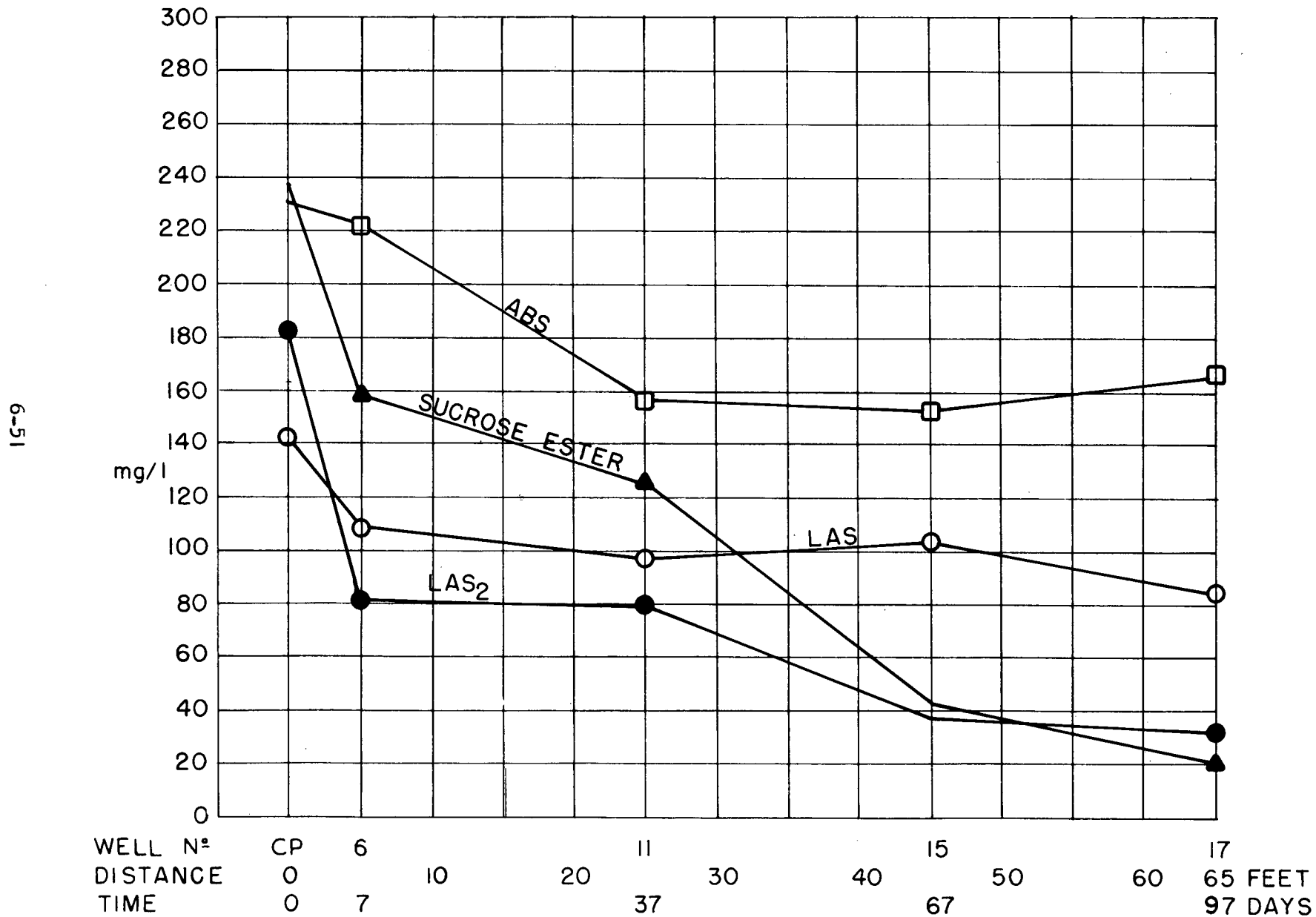
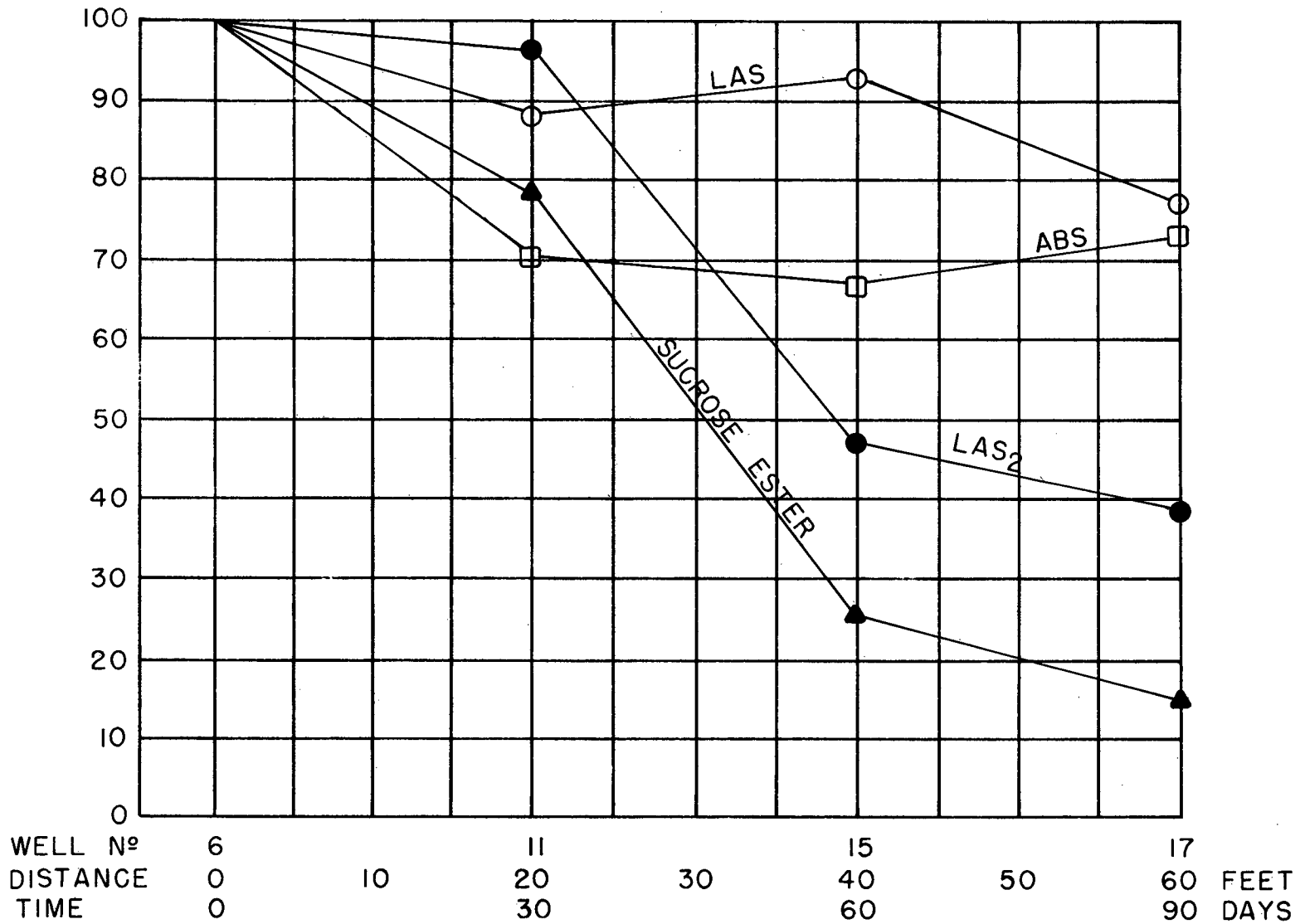

FIG. 6-25

LONG ISLAND GROUND WATER POLLUTION STUDY
 PERCENT REMAINING OF FIRST WELL CONCENTRATION
 COD (2/12/1963-3/14/1966)
 SITE N° 2 - WEST BABYLON, SUFFOLK COUNTY, N. Y.



6-52

FIG. 6-26

Adjusting for dilutional effects, based upon chloride reductions, indicated net COD reductions of :

	<u>Average Values</u>	
LAS ₁	0.56%/ft.	0.27%/day
LAS ₂	0.29	0.19
Sucrose Ester	1.61	1.08

5. In comparing COD reduction rates, it can be concluded that a greater reduction of soluble COD is being removed in the cesspool soil region than through the downstream saturated zone. The reduction of COD is an indicator of the extent to which organic matter in the waste was being removed. In the saturated soil zone net COD reduction rates indicated that factors besides that of dilution were effective in reducing the COD content of the waste.

BOD

1. Biochemical oxygen demand, BOD, in the disposal system varied with the use of each surfactant ranging between 120 and 345 mg/l. The highest BOD concentration occurred during the use of Soap product. (Table 6-3)

2. Ratios of BOD/COD varied with the use of each surfactant. In instances, ratios greater than 1.0 existed indicating possible laboratory error.

	<u>BOD</u>	<u>COD</u>	<u>BOD/COD</u>
ABS	224 mg/l	233 mg/l	0.96
LAS ₁	218	142	1.53
AS	190	---	---
Soap	345	---	---
LAS ₂	120	182	0.65
Sucrose Ester	257	236	1.09

3. Generally, Bod concentrations were significantly greater than suspended solids in the cesspool.

Total and Suspended Solids

1. In the disposal system, considerable variation existed in total and suspended solid values during use of the different surfactants. Total solids ranged between 399 and 592 mg/l, while suspended solids varied from 53 to 201 mg/l. (Table 6-3)

2. The largest total and suspended solid levels occurred during the use of Sucrose Ester and Soap, the formulations which also exhibited the greatest amounts of BOD.

	<u>Total Solids</u>	<u>Suspended Solids</u>	<u>BOD</u>
ABS	567 mg/l	63 mg/l	224 mg/l
LAS ₁	576	75	218
AS	496	64	190
Soap	576	201	345
LAS ₂	399	53	120
Sucrose Ester	592	83	257

Septic Tank

1. Samples collected from the septic tank preceding the cesspool during the use of Sucrose Ester indicated the septic tank was not an efficient unit for the removal of most sewage constituents. (Table 6-3)

2. Average concentrations in the septic tank, cesspool and percent reductions during the use of Sucrose Ester were:

	<u>Septic Tank</u>	<u>Cesspool</u>	<u>Reduction</u>
Sucrose Ester (MBAS)	3.3 mg/l	5.3 mg/l	+60.5%
Ammonia	63.5	60.0	5.5
Chlorides	56.0	55.5	0.9
Total PO ₄	113.0	122.0	+ 8.0
Spec. Cond.	----	----	-----
Alkalinity	356.0	345.0	3.1
Sulfates	92.8	29.0	68.8
Coliform (Log)	1.56 x 10 ⁶	1.67 x 10 ⁶	+ 7.0
Nitrites	0.02	0.02	-----

(continued)

	<u>Septic Tank</u>	<u>Cesspool</u>	<u>Reduction</u>
Nitrates	0.07	0.07	-----
COD	270.0	236.0	12.6
BOD	265.0	257.0	3.0
Total Solids	587.0	592.0	0.86
Sus. Solids	150.0	83.0	44.5

3. Significant reduction, 44.5 percent, of suspended solids resulted during the retention period of the septic tank. Cognizance must be taken that the primary purpose of a septic tank is to remove solid matter and therefore prolong the life of the cesspool leaching system. For this sole purpose, the septic tank was effective.

4. Although a significant reduction in suspended solids resulted, 44.6 percent, there was an extremely small corresponding BOD reduction, 3.0 percent, through the septic tank.

5. The results of the removals studied indicate that the septic tank has little effect on reducing the amount of contaminants entering the cesspool.

Table 6-3
Site No. 2
BOD and Solids

	ABS	LAS ₁	AS	Soap	LAS ₂	Sucrose Ester
<u>Cesspool</u>						
BOD	224.	218.	190.	345.	120.	257.
Total Solids	567.	516.	496.	575.	399.	592.
Suspended Solids	68.	75.	64.	201.	53.	83.
<u>Septic Tanks</u>						
BOD						265.
Total Solids						587.
Suspended Solids						150.

LONG ISLAND GROUND WATER POLLUTION STUDY
 REDUCTION VERSUS TRAVEL TIME
 ABS IN USE (2/12/1963-6/1/1963)
 SITE N° 2 - WEST BABYLON, SUFFOLK COUNTY, N. Y.

6-57

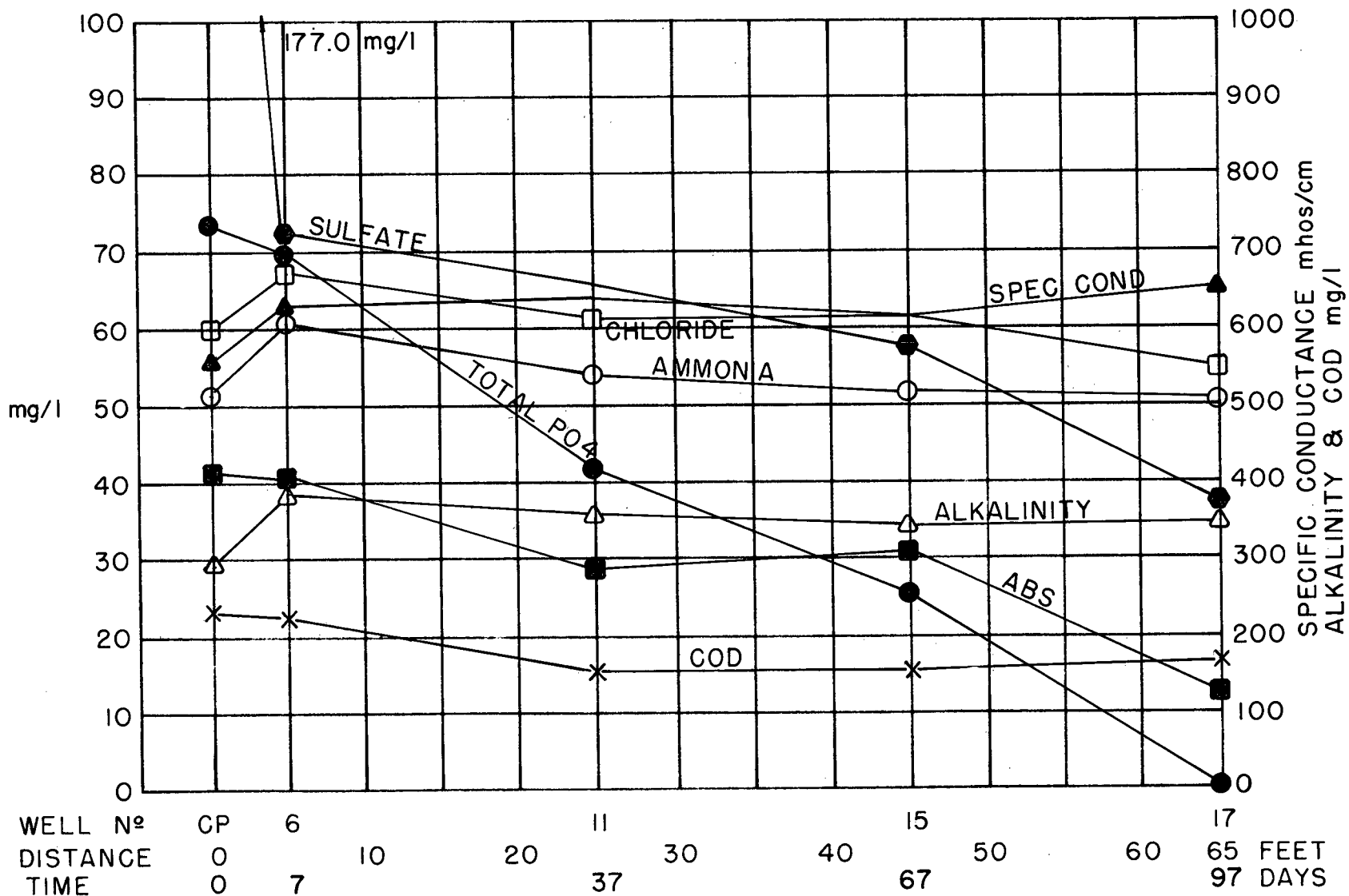
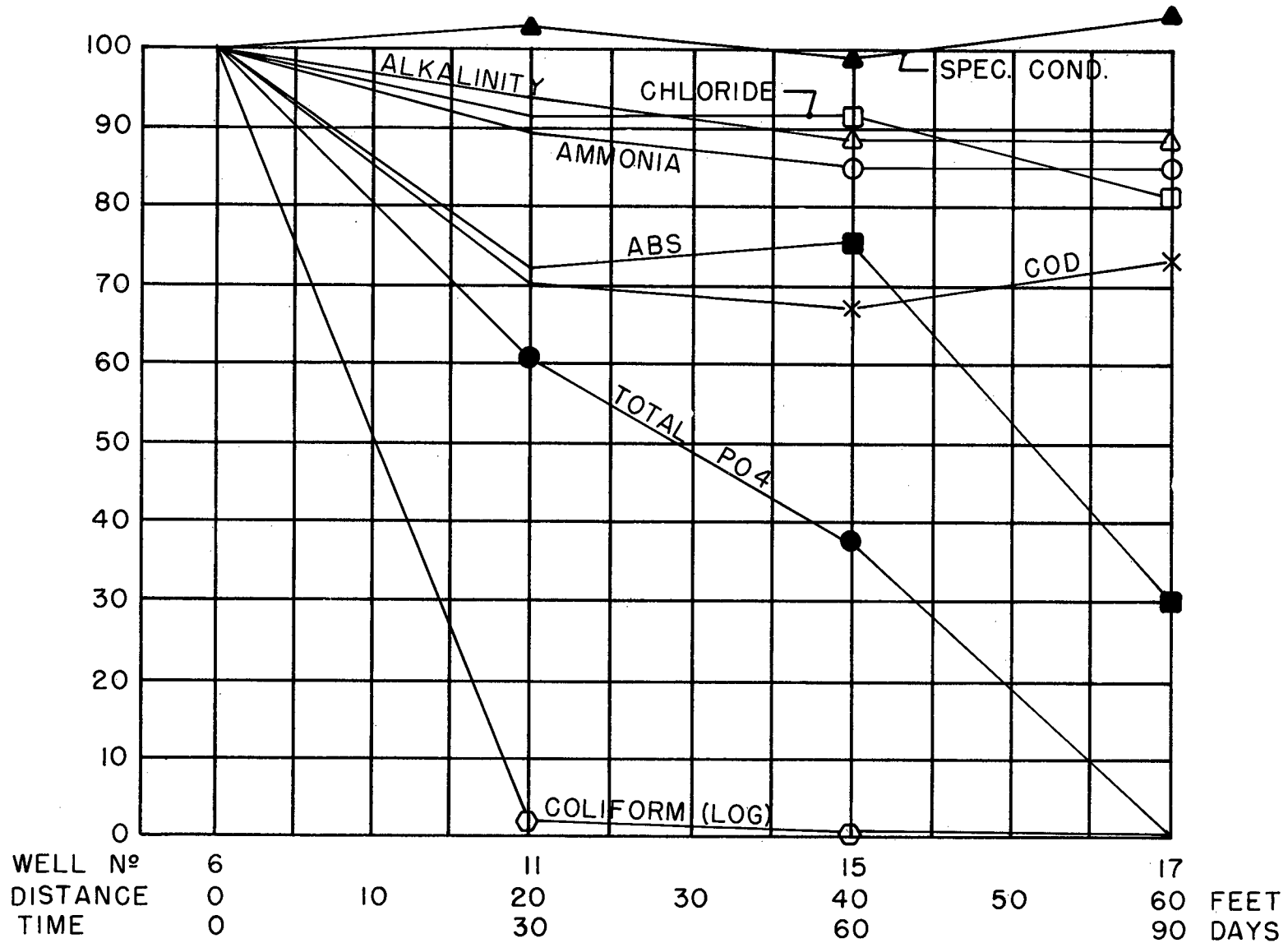

FIG. 6-27

LONG ISLAND GROUND WATER POLLUTION STUDY
 PERCENT REMAINING OF FIRST WELL CONCENTRATION
 ABS IN USE (2/12/1963-6/1/1963)
 SITE N° 2 - WEST BABYLON, SUFFOLK COUNTY, N. Y.



6-58

FIG. 6-28

LONG ISLAND GROUND WATER POLLUTION STUDY
 REDUCTION VERSUS TRAVEL TIME
 LAS IN USE (6/1/1963 - 4/22/1964)
 SITE N° 2 - WEST BABYLON, SUFFOLK COUNTY, N. Y.

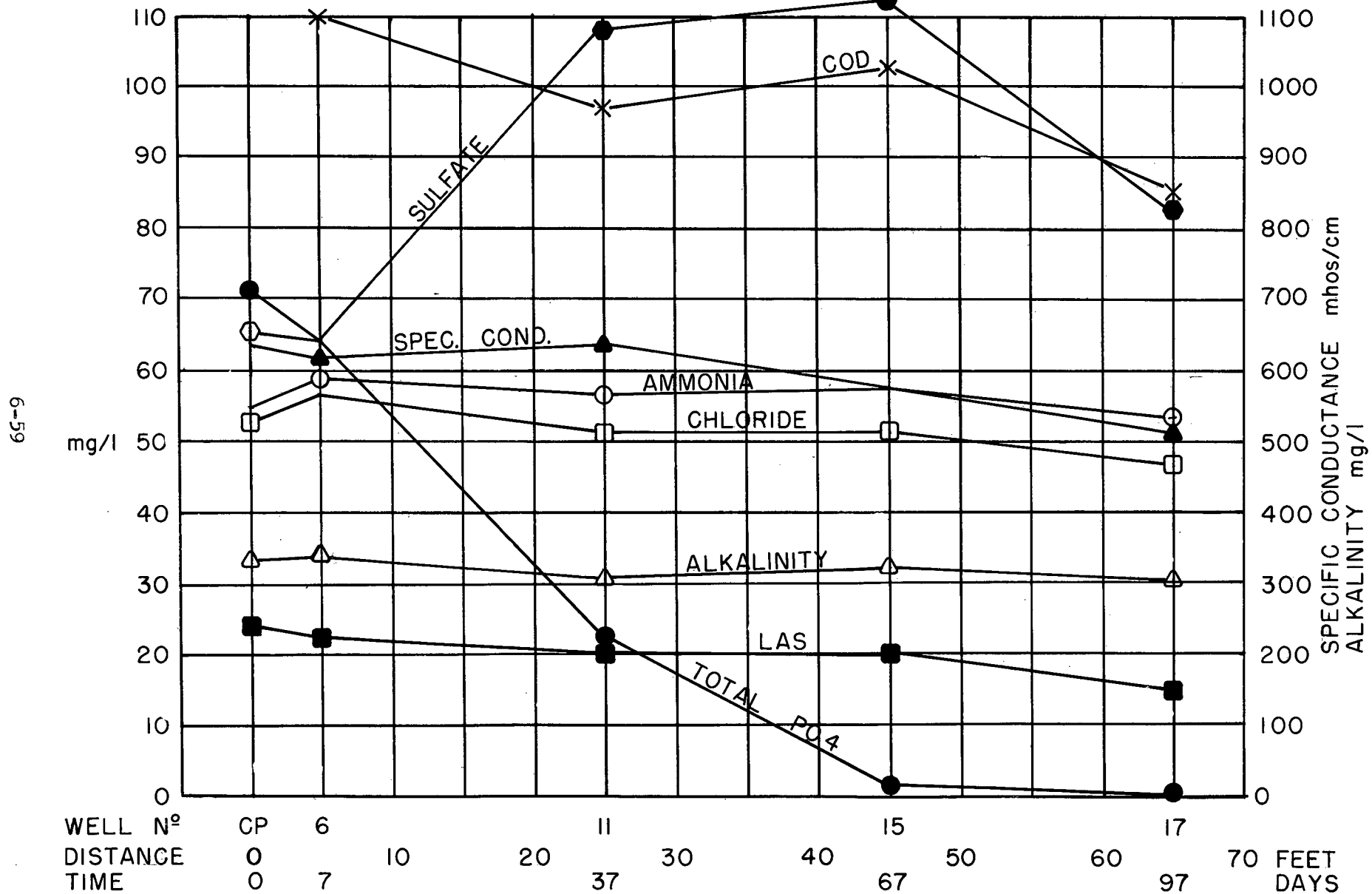
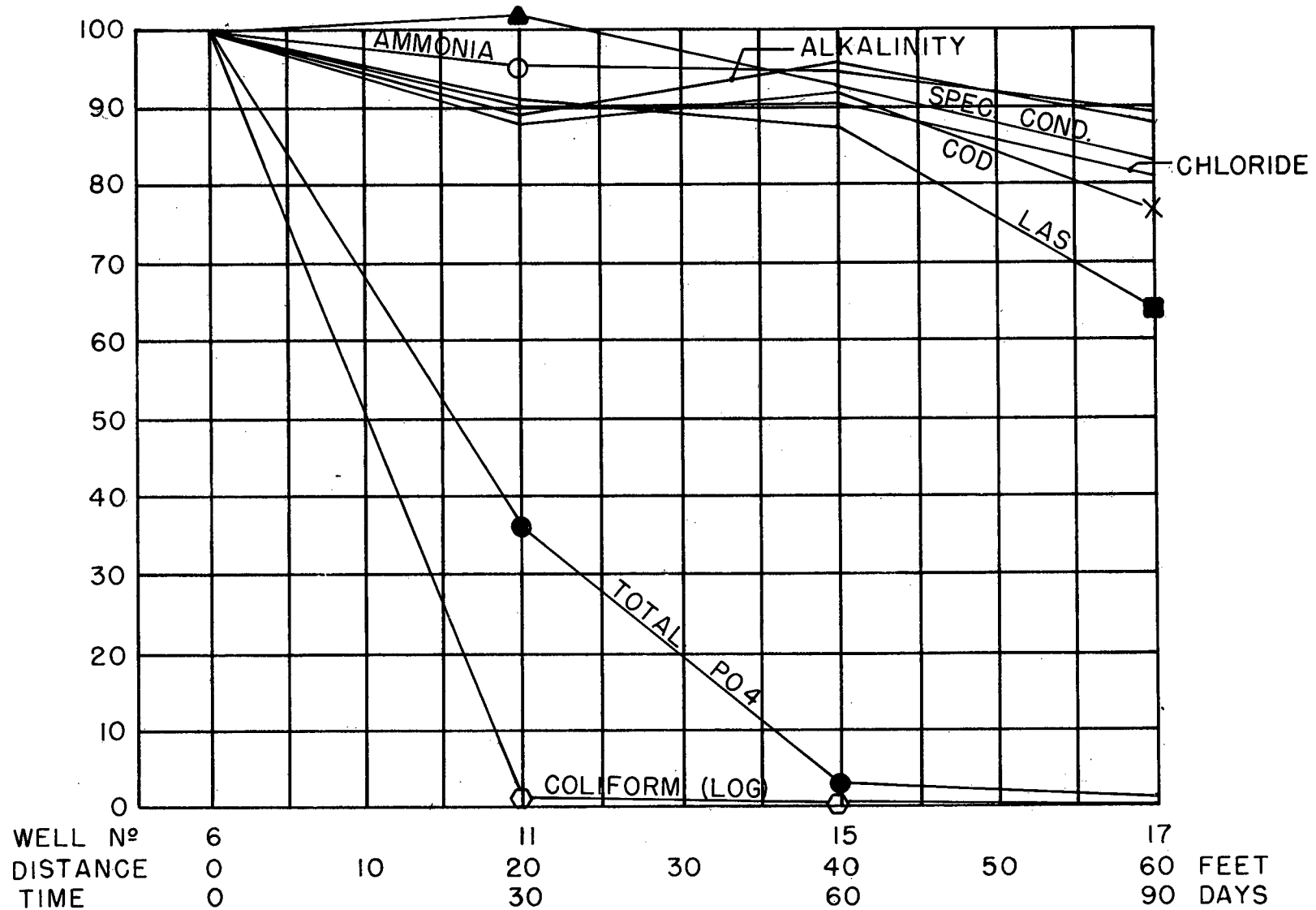

FIG. 6-29

LONG ISLAND GROUND WATER POLLUTION STUDY
 PERCENT REMAINING OF FIRST WELL CONCENTRATION
 LAS IN USE (6/1/1963 - 4/22/1964)
 SITE Nº 2 - WEST BABYLON, SUFFOLK COUNTY, N. Y.



09-9

FIG. 6-30

LONG ISLAND GROUND WATER POLLUTION STUDY
 REDUCTION VERSUS TRAVEL TIME
 AS IN USE (4/22/1964-12/7/1964)
 SITE N° 2 - WEST BABYLON, SUFFOLK COUNTY, N. Y.

19-9

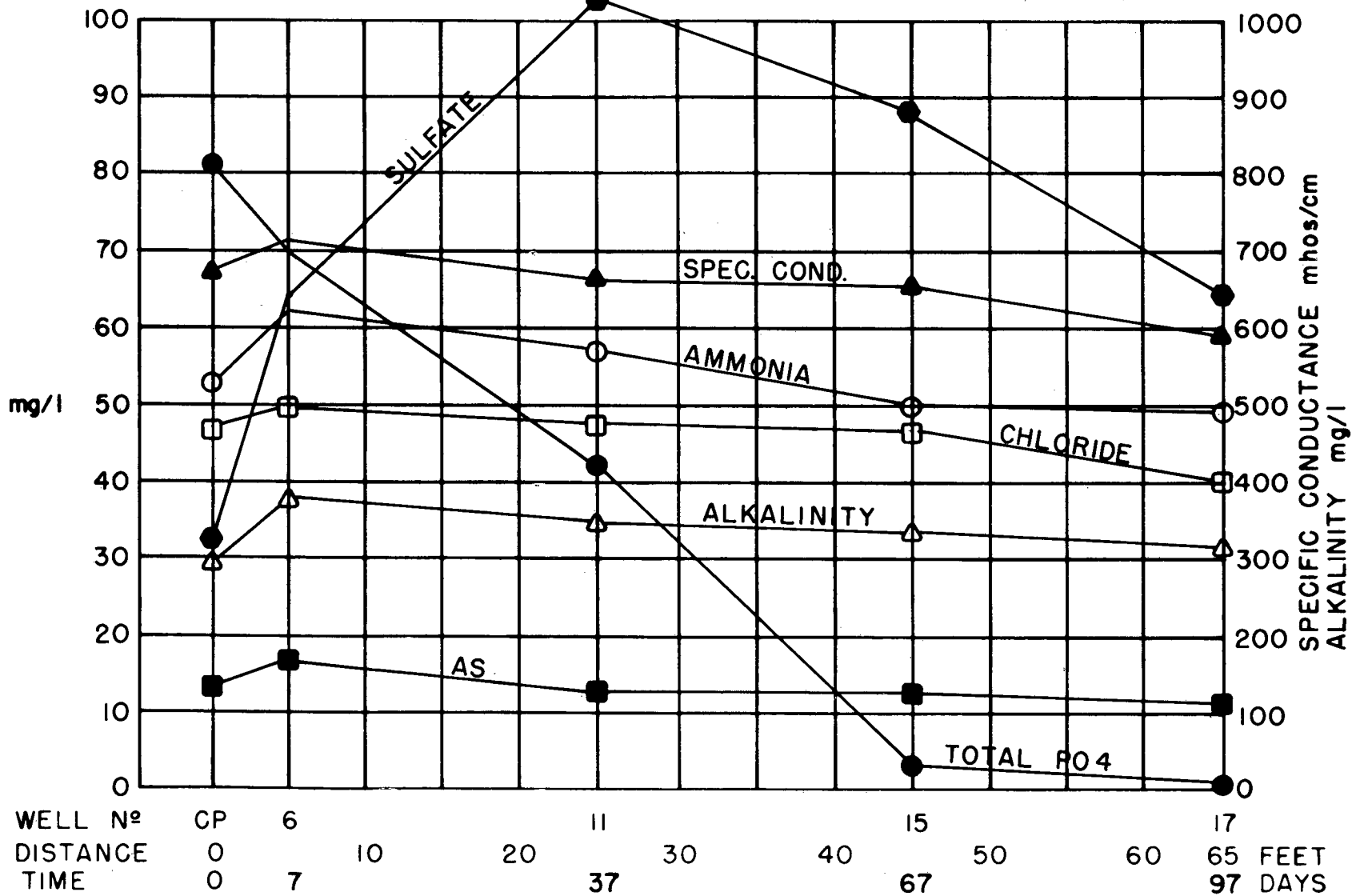
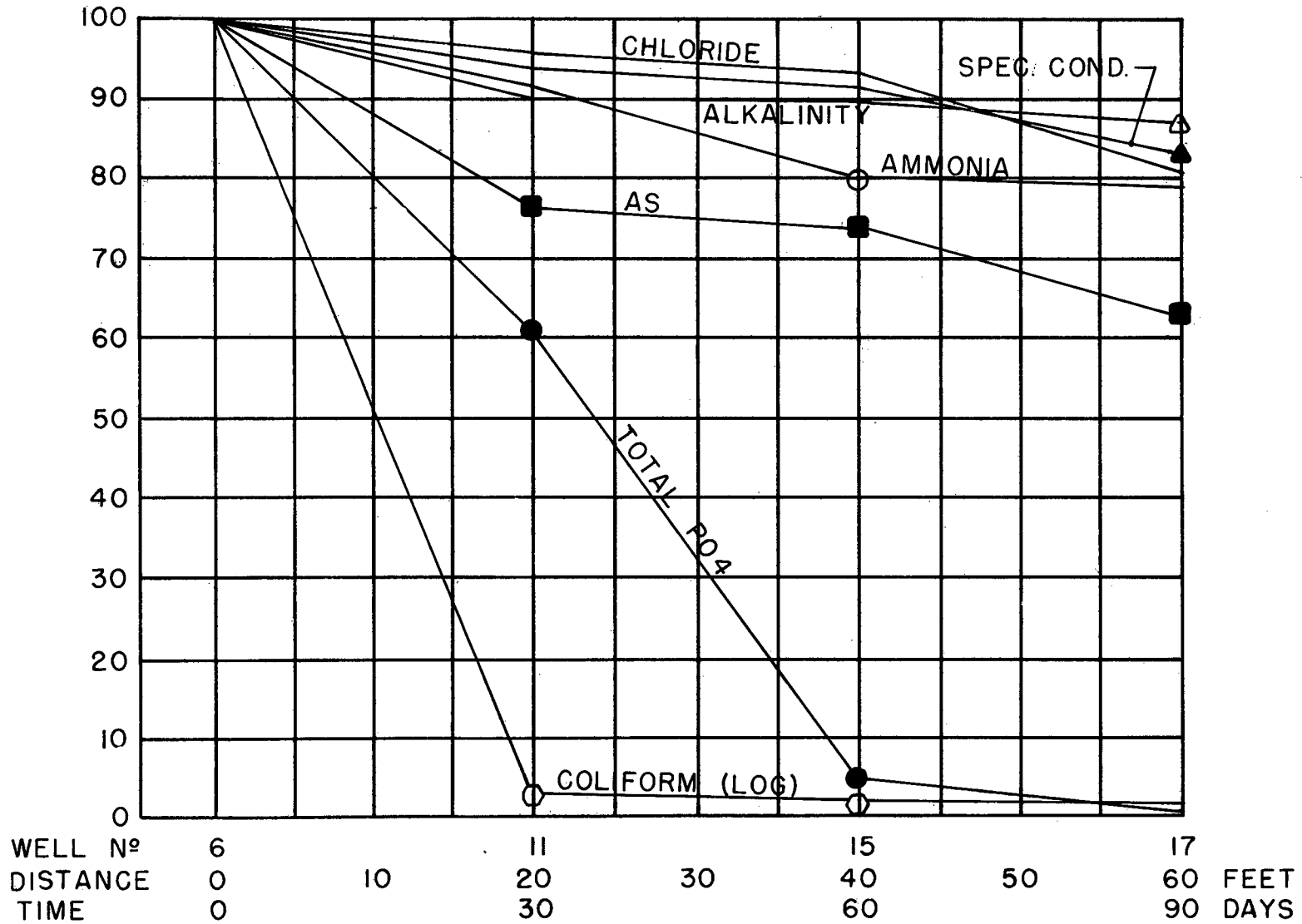

FIG. 6-31

LONG ISLAND GROUND WATER POLLUTION STUDY
 PERCENT REMAINING OF FIRST WELL CONCENTRATION
 AS IN USE (4/22/1964-12/7/1964)
 SITE Nº 2 - WEST BABYLON, SUFFOLK COUNTY, N. Y.



6-62

FIG. 6-32

LONG ISLAND GROUND WATER POLLUTION STUDY
 REDUCTION VERSUS TRAVEL TIME
 SOAP IN USE (12/7/1964-8/24/1965)
 SITE N° 2 - WEST BABYLON, SUFFOLK COUNTY, N. Y.

6-63

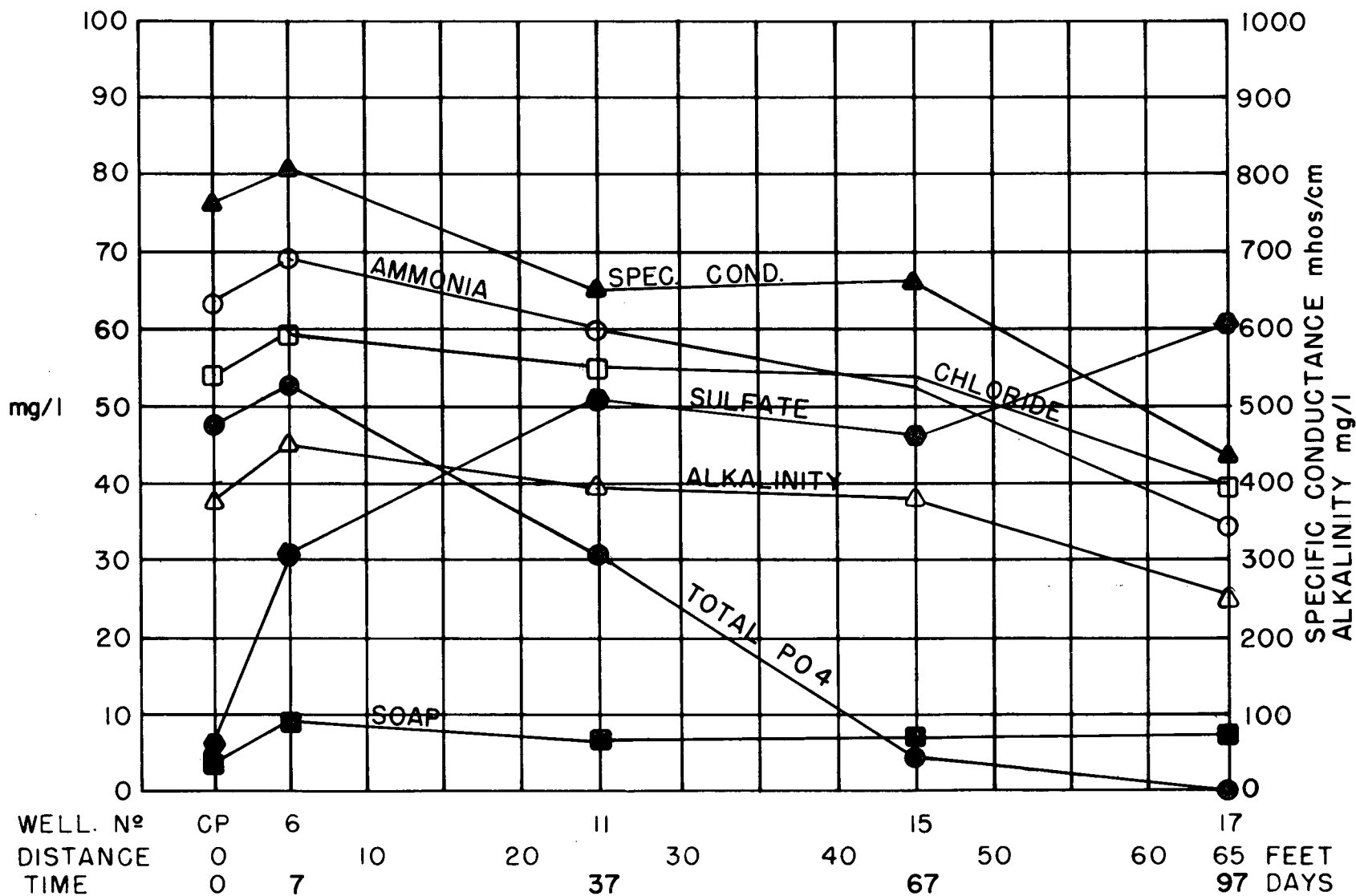
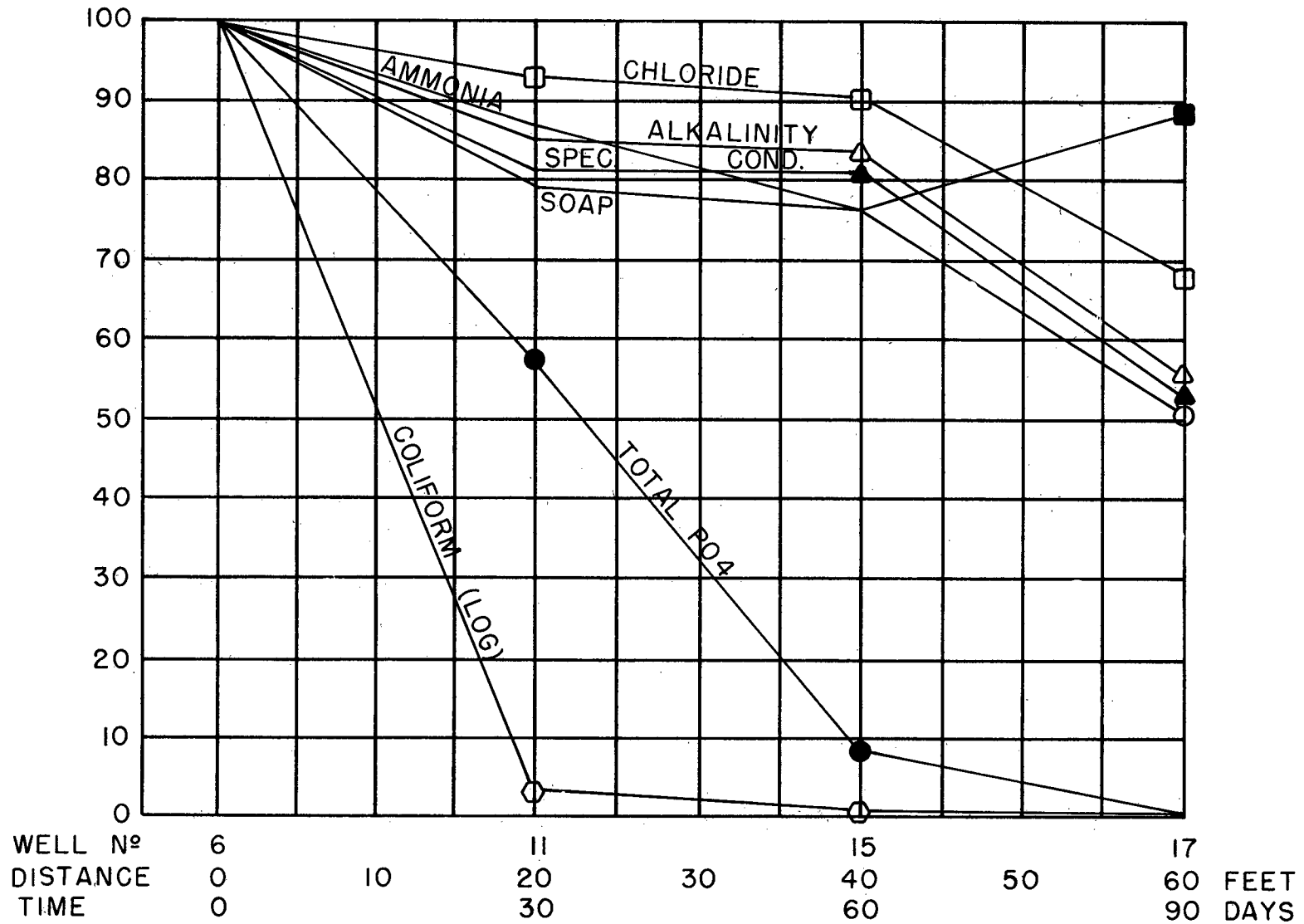

FIG. 6-33

LONG ISLAND GROUND WATER POLLUTION STUDY
 PERCENT REMAINING OF FIRST WELL CONCENTRATION
 SOAP IN USE (12/1/1964 - 8/24/1965)
 SITE N° 2 - WEST BABYLON, SUFFOLK COUNTY, N. Y.



6-64

FIG. 6-34

LONG ISLAND GROUND WATER POLLUTION STUDY
 REDUCTION VERSUS TRAVEL TIME
 LAS IN USE (8/24/1965-11/22/1965)
 SITE N° 2 - WEST BABYLON, SUFFOLK COUNTY, N. Y.

6-65

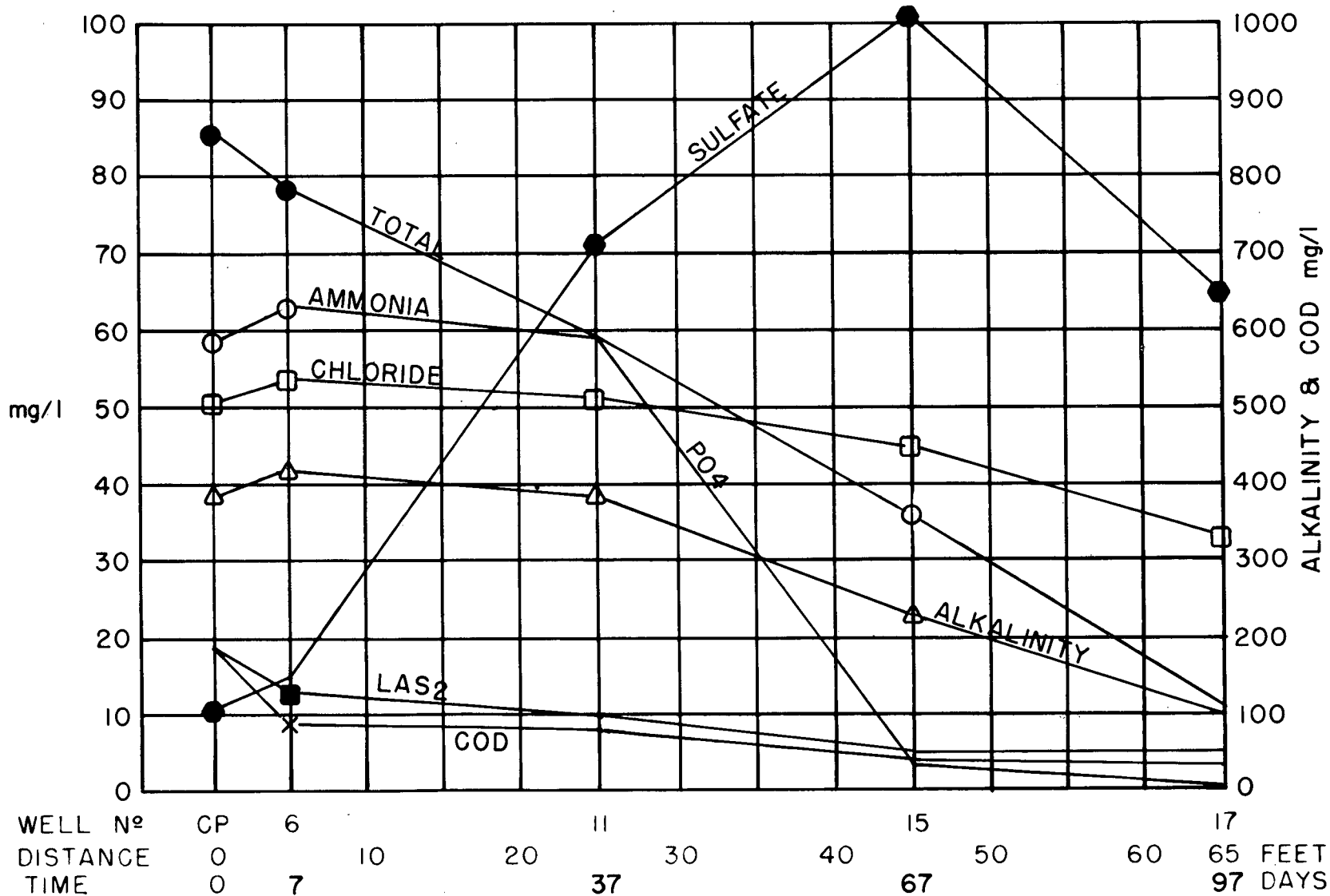
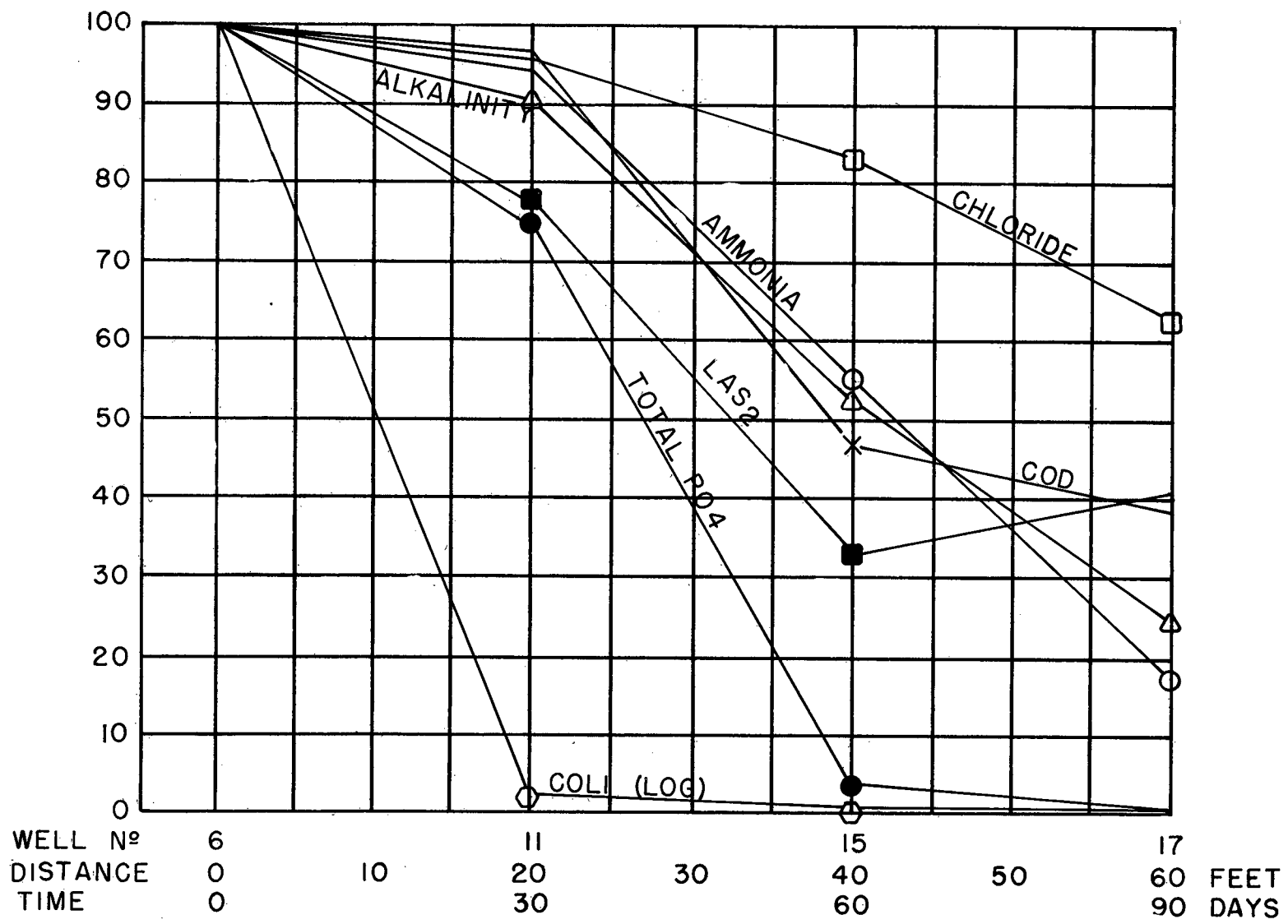

FIG. 6-35

LONG ISLAND GROUND WATER POLLUTION STUDY
 PERCENT REMAINING OF FIRST WELL CONCENTRATION
 LAS IN USE (8/24/1965-11/22/1965)
 SITE N° 2 - WEST BABYLON, SUFFOLK COUNTY, N. Y.



99-9
6-66

FIG. 6-36

LONG ISLAND GROUND WATER POLLUTION STUDY
 REDUCTION VERSUS TRAVEL TIME
 SUCROSE ESTER IN USE (11/22/1965-3/14/1966)
 SITE N° 2 - WEST BABYLON, SUFFOLK COUNTY, N. Y.

6-67

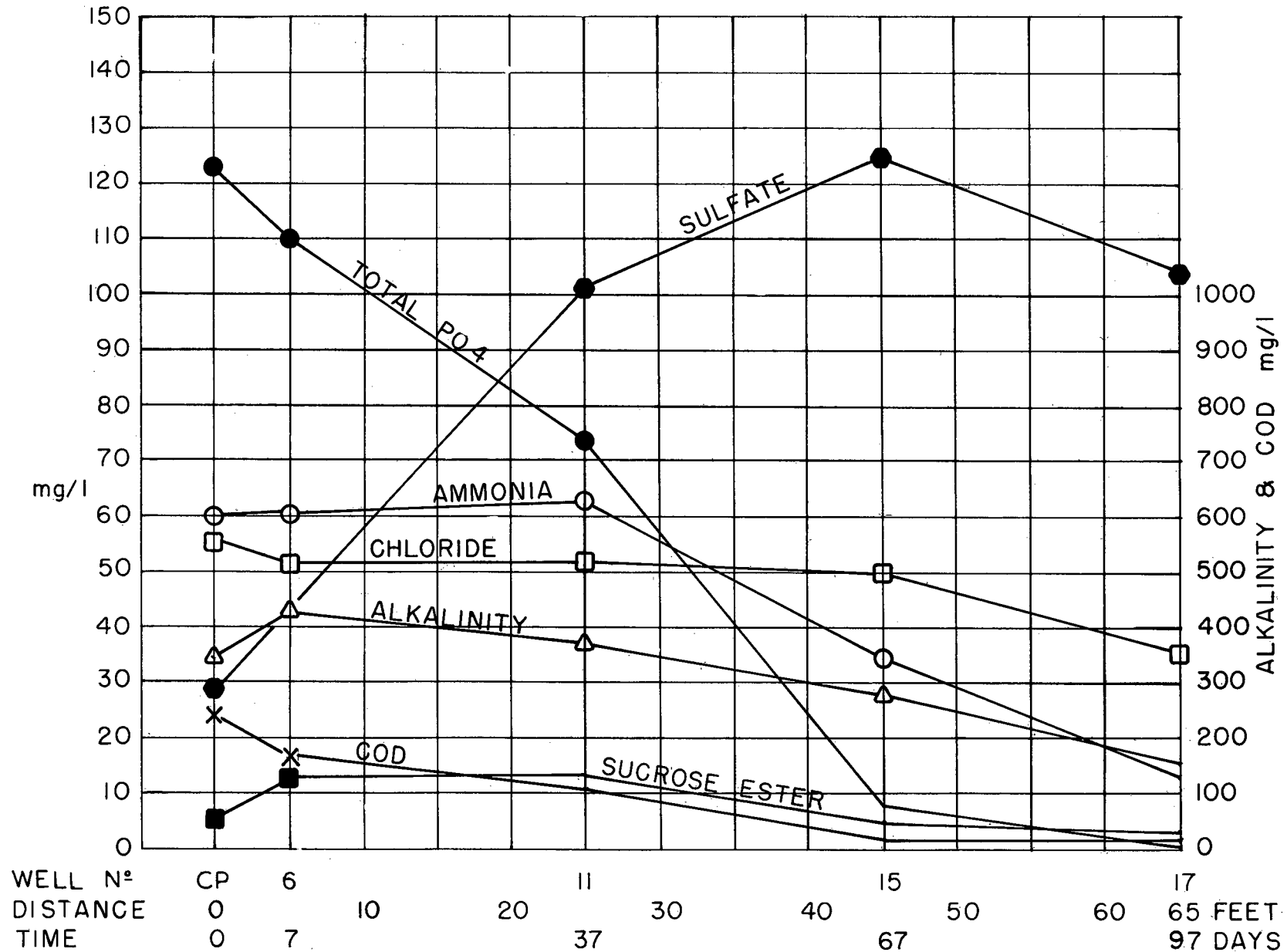
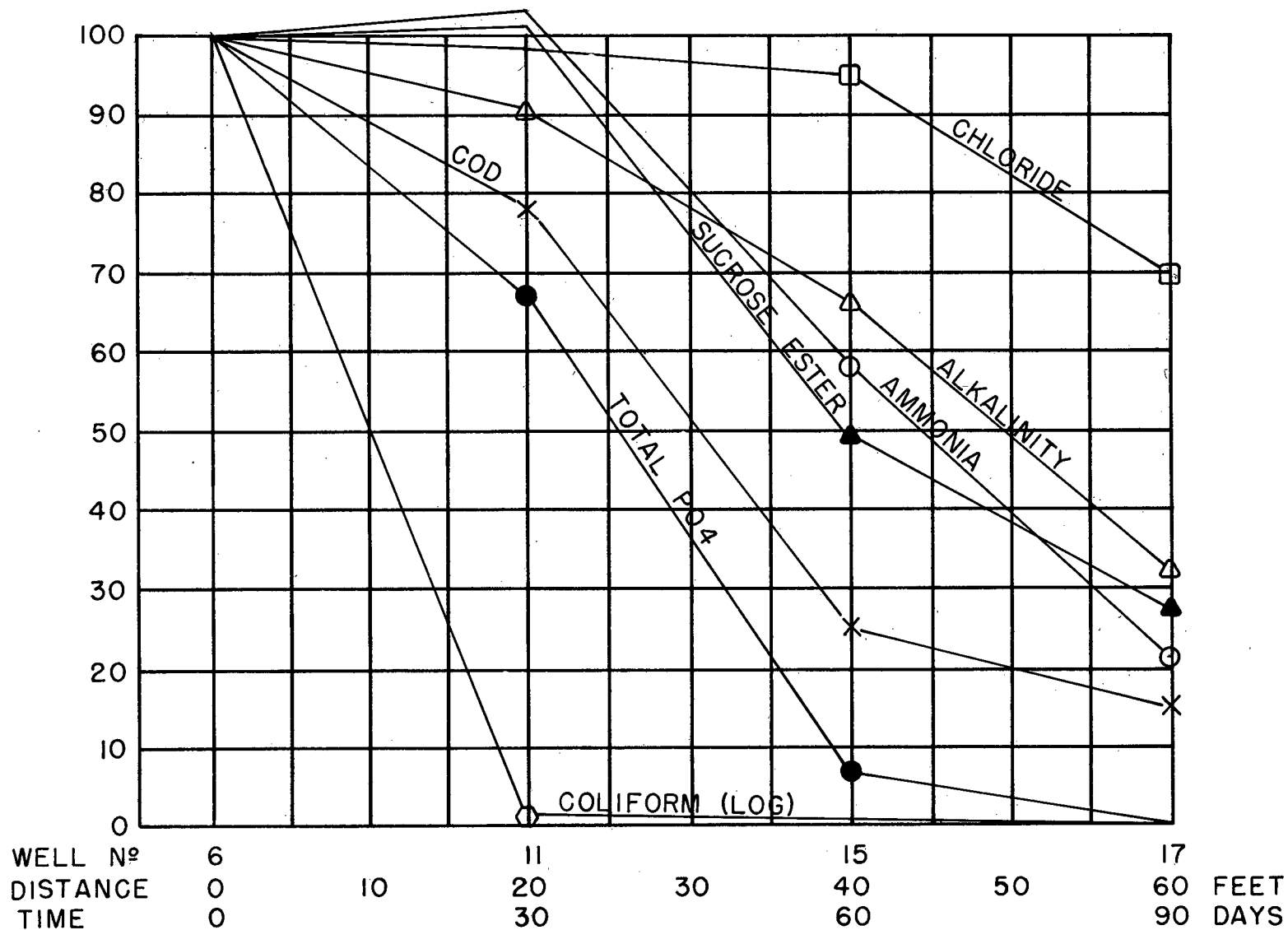

FIG. 6-37

LONG ISLAND GROUND WATER POLLUTION STUDY
 PERCENT REMAINING OF FIRST WELL CONCENTRATION
 SUCROSE ESTER IN USE (11/22/1965-3/14/1966)
 SITE Nº 2 - WEST BABYLON, SUFFOLK COUNTY, N. Y.



89-9

FIG. 6-38

PART 7 - SITE 3

Description and Development

The site is located on the east side of Central Avenue north of Church Street in Bohemia, Town of Brookhaven, Suffolk County. It is a one-story domestic residence occupied by three adults and five children. The house has been occupied since 1957.

The domestic sewage disposal system consists of a single 8 foot diameter by 14 foot depth cesspool constructed of standard concrete leaching block. Water supply for the home is obtained from an 1 1/4 inch diameter well, 82 feet deep. A water meter was installed on the pump discharge to record water usage.

The family began using the test detergent in June, 1963. The detergent products employed, quantity used and water use are given in Table 4-3.

Initial investigation of the site consisted of a probe hole drilled to a total depth of 62 feet, approximately six feet southeast of the cesspool. The auger and core samples withdrawn indicate a typical glacial material.

The cesspool cover was drilled to receive a sampling point and a support tube in which a Stevens level recorder was installed. This unit was installed in order to establish and record the liquid level fluctuations in the cesspool.

Seven water-level observation wells were drilled in the area of the pool and at selected sites up and down gradient. (Figure 7-1) Water level elevations were obtained and plotted by the United States Geological Survey to establish both the mound effect of the discharge of the pool at the ground water surface, and the ground water contours to determine ground water flow direction.

Probe wells were driven in a line through the cesspool and parallel to ground water flow direction, and sampled at one-foot increments in depth to establish water quality. Each water sample was analyzed both in the field and the laboratories for MBAS and other critical constituents in order to establish

CENTRAL AVE.

N 5° 57' 20" E

SYNDET TEST SITE
CENTRAL AVE. BOHEMIA
APPROXIMATE CONFIGURATION OF
THE WATER TABLE CONTOURS
JUNE 18, 1963

NOTE.

CONTOUR ELEVATIONS ARE
BASED ON ARBITRARY DATUM
OF 100 FEET.
JS-USGS 6-19-63

7-2

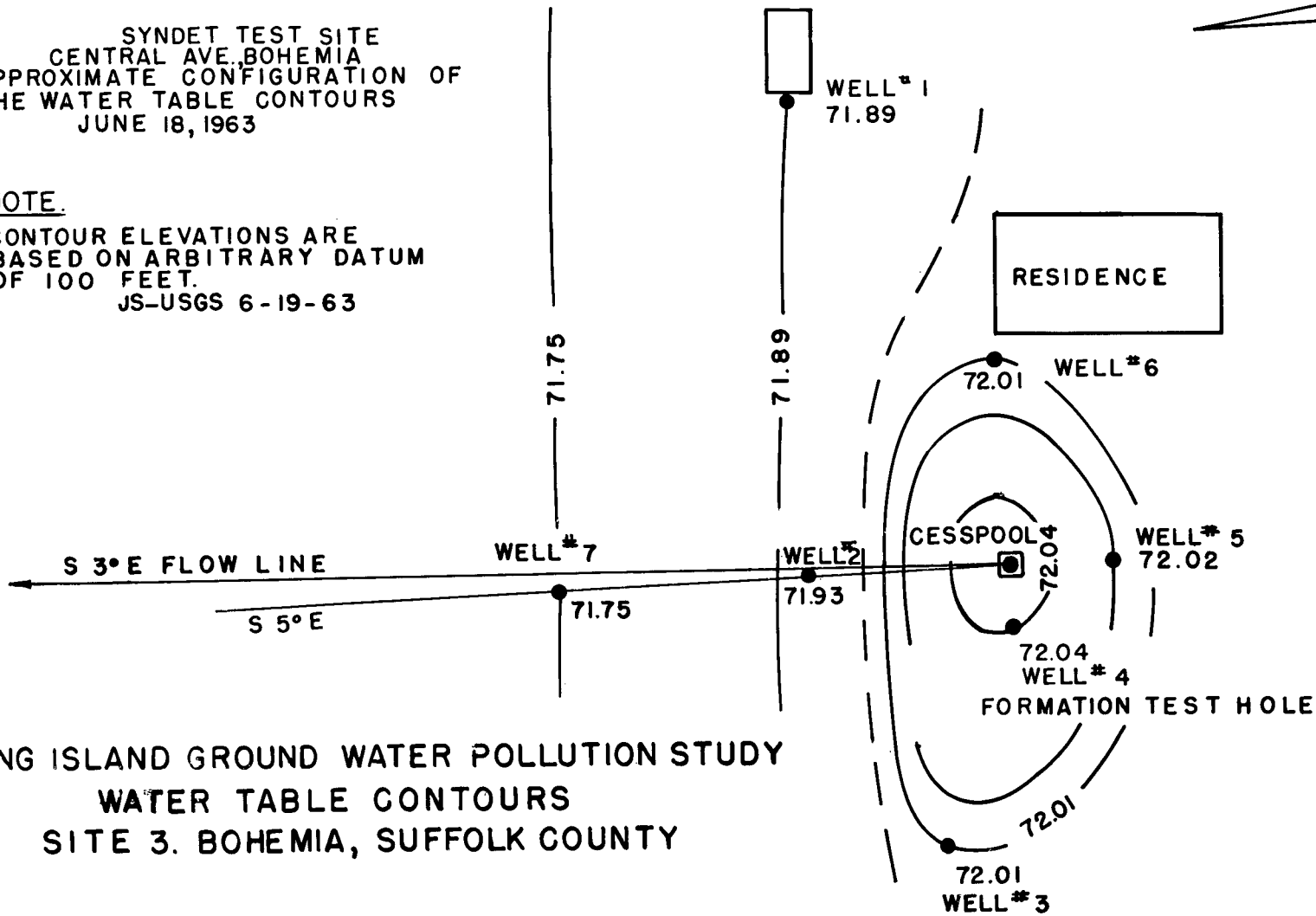

LONG ISLAND GROUND WATER POLLUTION STUDY
WATER TABLE CONTOURS
SITE 3. BOHEMIA, SUFFOLK COUNTY

the pattern of the cesspool effluent in the ground water body. Permanent 2 inch diameter test wells were then installed. (Figure 7-3, 4, 5) The well screens were 12 inch long points with elevations established to intersect the vertical pattern of the sewage slug.

A deep-well hand pump was successfully used in the early stages of sampling although extreme difficulty was encountered in the priming and pumping due to the 28 feet, 6 inch water level. Considerable prime water was required for each operation and it was felt that an unreliable sample might be secured due to this dilution effect. Rod pumps were then installed in each test well in the hopes that this would ease the pumping problem. However, the infrequency of pumping allowed corrosion products to form on the seats and cylinders of these pumps thereby making them difficult to operate.

The problem was resolved by use of an electrically driven vacuum pump interconnected with two one-gallon vacuum bottles by means of a valving manifold. (Figure 7-6) Operation of the vacuum pump resulted in a flow of water to bottle number 1. When bottle No. 1 was filled the valves were manipulated to bypass bottle No. 1 and fill bottle No. 2. Bottle No. 1 was discarded as being residual water laying in the casing above the screen and not necessarily representative of formation quality. Bottle No. 2 was then drained into the required sample vessels for delivery to the laboratories. This procedure eliminated the priming water dilution problem and resulted in minimal withdrawal from the formation, thereby minimizing the hydraulic effect upon the normal ground water flow.

Test wells were pumped on alternate weeks and samples delivered to the participating laboratories for analysis.

During the course of the project, a lowering of the water table occurred due to a sustained county-wide drought. The static water level was 28 feet, 6 inches in June, 1963 and dropped to 29 feet, 5 inches by November 29, 1963. This necessitated the installation of additional test wells to greater depth as well as the deepening of existing wells so as to maintain the sampling points in the center of the sewage slug.

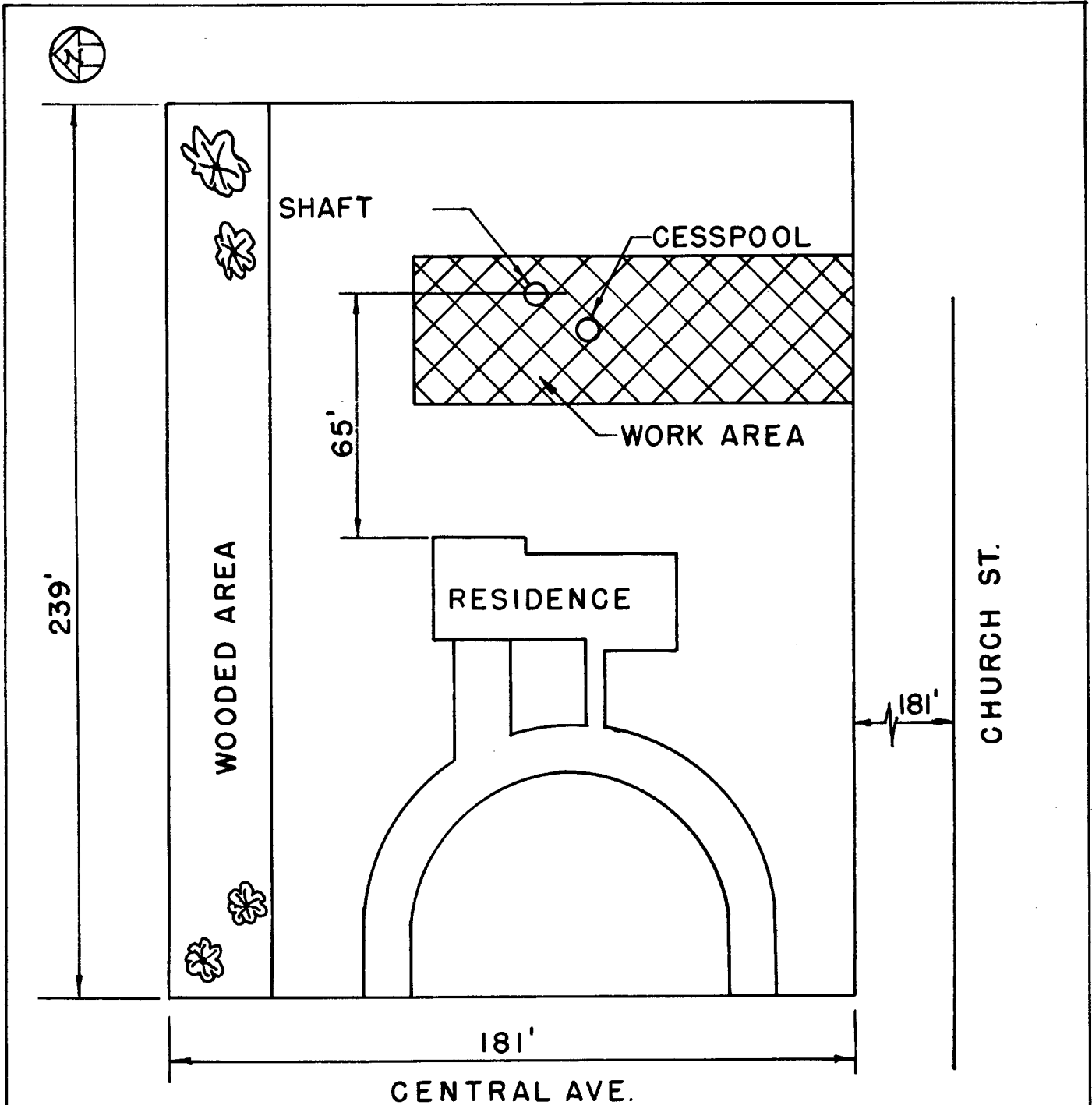

LONG ISLAND GROUND WATER POLLUTION STUDY
PLOT PLAN
SITE 3. BOHEMIA, SUFFOLK COUNTY

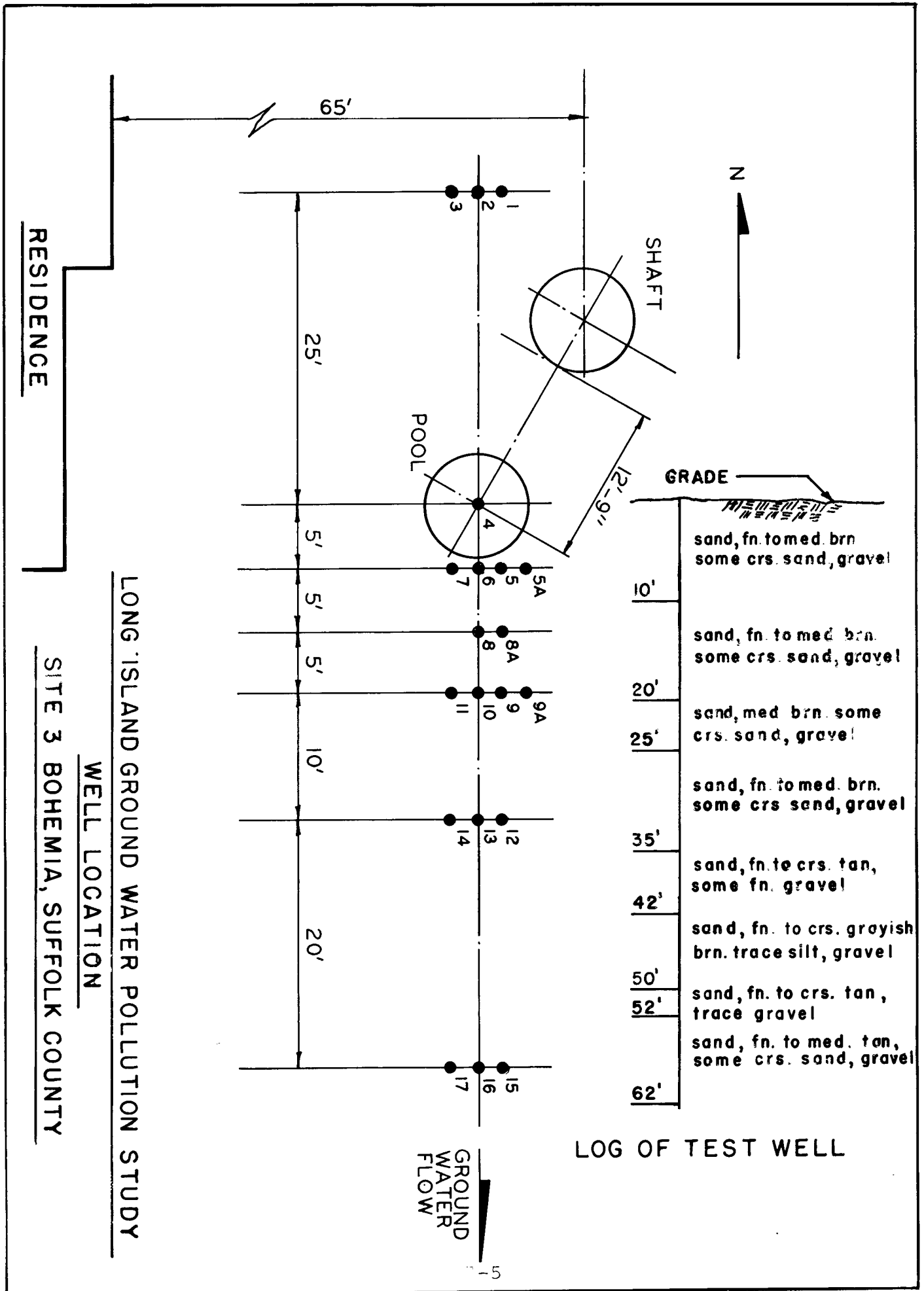

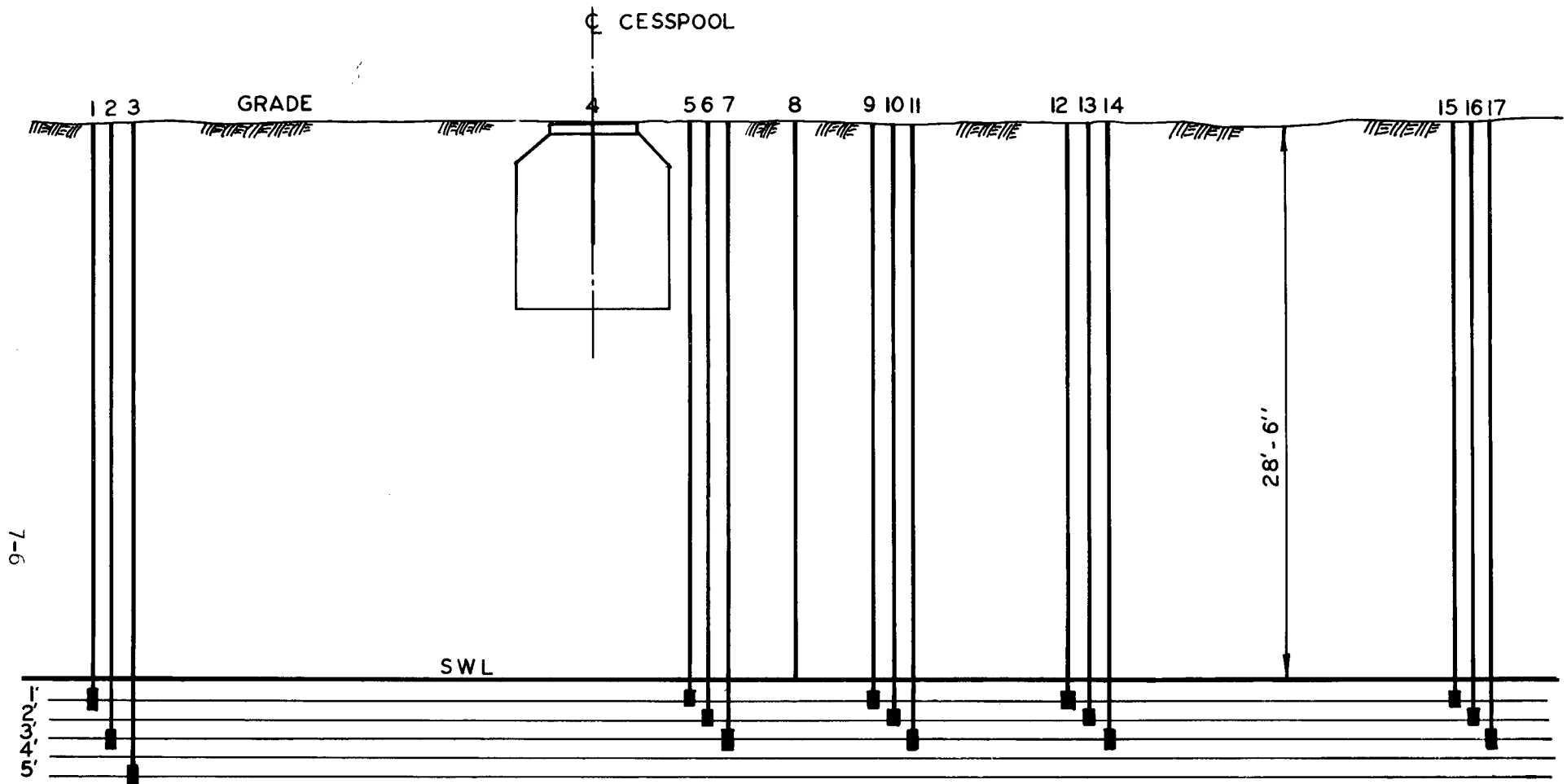

7-6

5
4
3
2
1

LONG ISLAND GROUND WATER POLLUTION STUDY
 WELL PROFILE
 SITE 3. BOHEMIA, SUFFOLK COUNTY

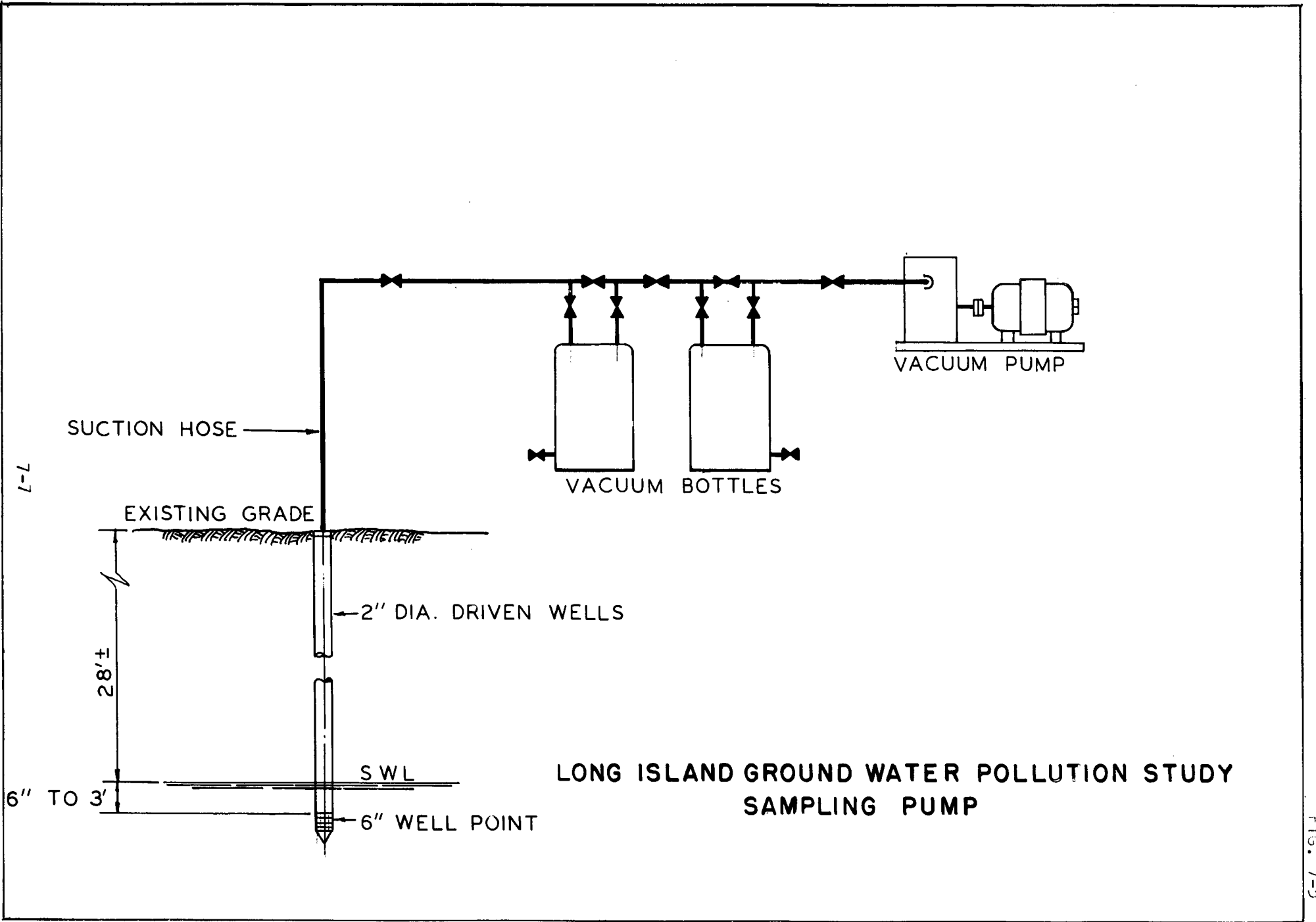

FIG. 7-5

Wells 5a, 8a, and 9a were installed using 6 inch effective length screens to reduce the area of sampling influence.

The cesspool was emptied by a scavenger truck in order to remove detergents used by the homeowner, prior to the research project.

Sampling from Unsaturated Soil

In addition to investigating waste flow through the saturated sands the study group wished to investigate the flow of waste through the unsaturated sands beneath the cesspool. The U.S. Public Health Service Soil Science Division was also interested in these details. Consideration was given to a number of alternate plans. With the guidance of William Bendixon, Senior Soil Scientist, there evolved the design of a sampling shaft. (Figure 7-7, 8, 9)

The shaft was constructed of 8 ft. diameter 4 ft. high precast concrete sections. In order to avoid disturbance of the area next to the cesspool, the sampling shaft was installed by bailing in the precast sections. The first section was set in an open excavation. Each subsequent ring was then strapped to the prior one and excavation carried out from within the ring. The weight of the concrete sections were sufficient to carry the first three rings down. At this point the frictional effect of the soil on the outside of the rings slowed the procedure to a virtual standstill. At this time, a wooden cover was placed over the top ring and an additional ring placed on the cover. This top ring was filled with sand for additional weight and another ring used to pound the sections down. This procedure was continued until the shaft was installed to a depth of 28 feet from ground surface.

Operating platforms were constructed at three levels in the shaft. Miscellaneous mechanical equipment was installed including a ventilating blower, access ladder, and a removable access cover set on the top.

Gravity samplers constructed of 2 1/2 inch PVC plastic pipe were installed as shown on the drawings. Installation was accomplished by means of placing

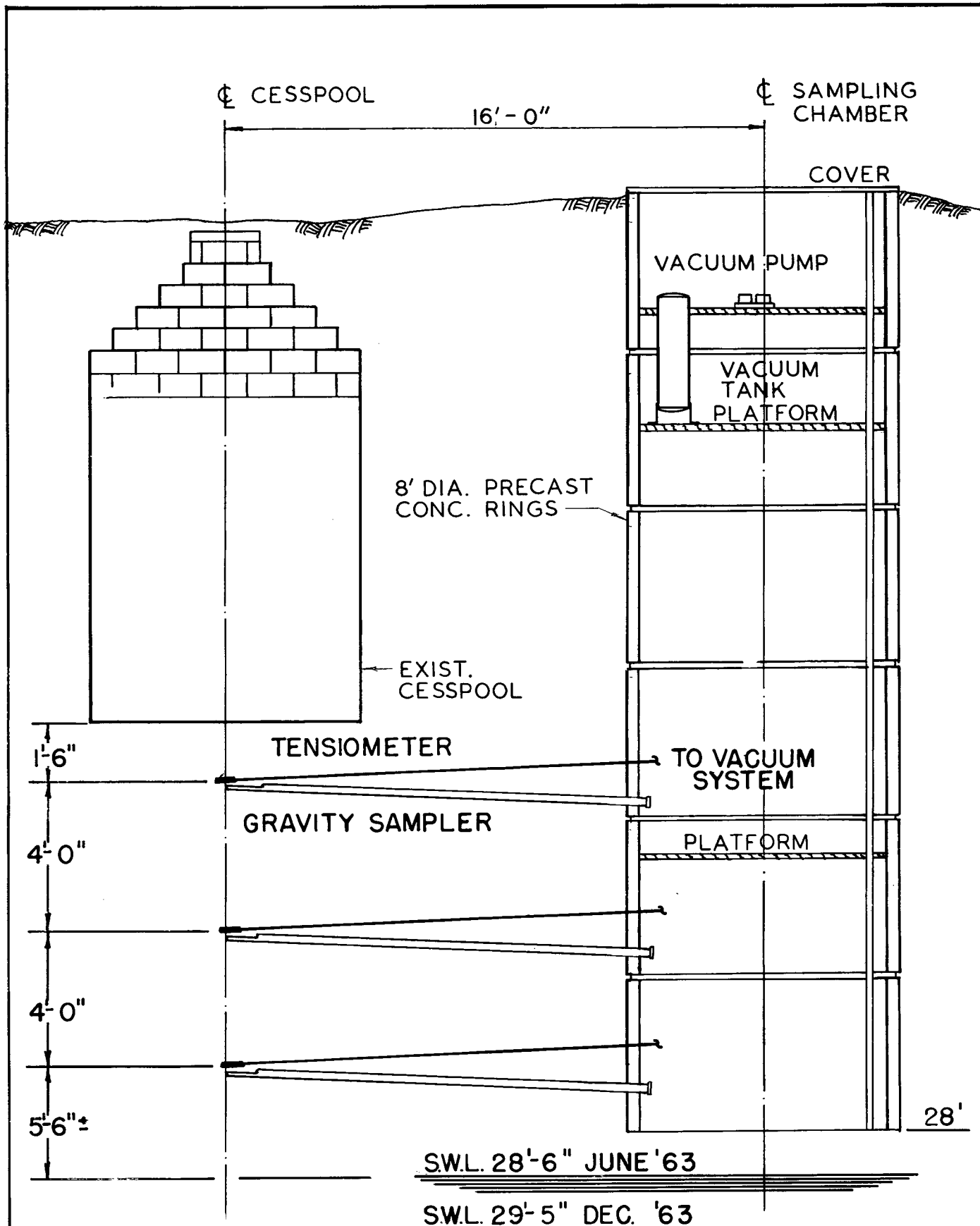

LONG ISLAND GROUND WATER POLLUTION STUDY
 CROSS SECTION CESSPOOL and SHAFT
 SITE 3. BOHEMIA, SUFFOLK COUNTY

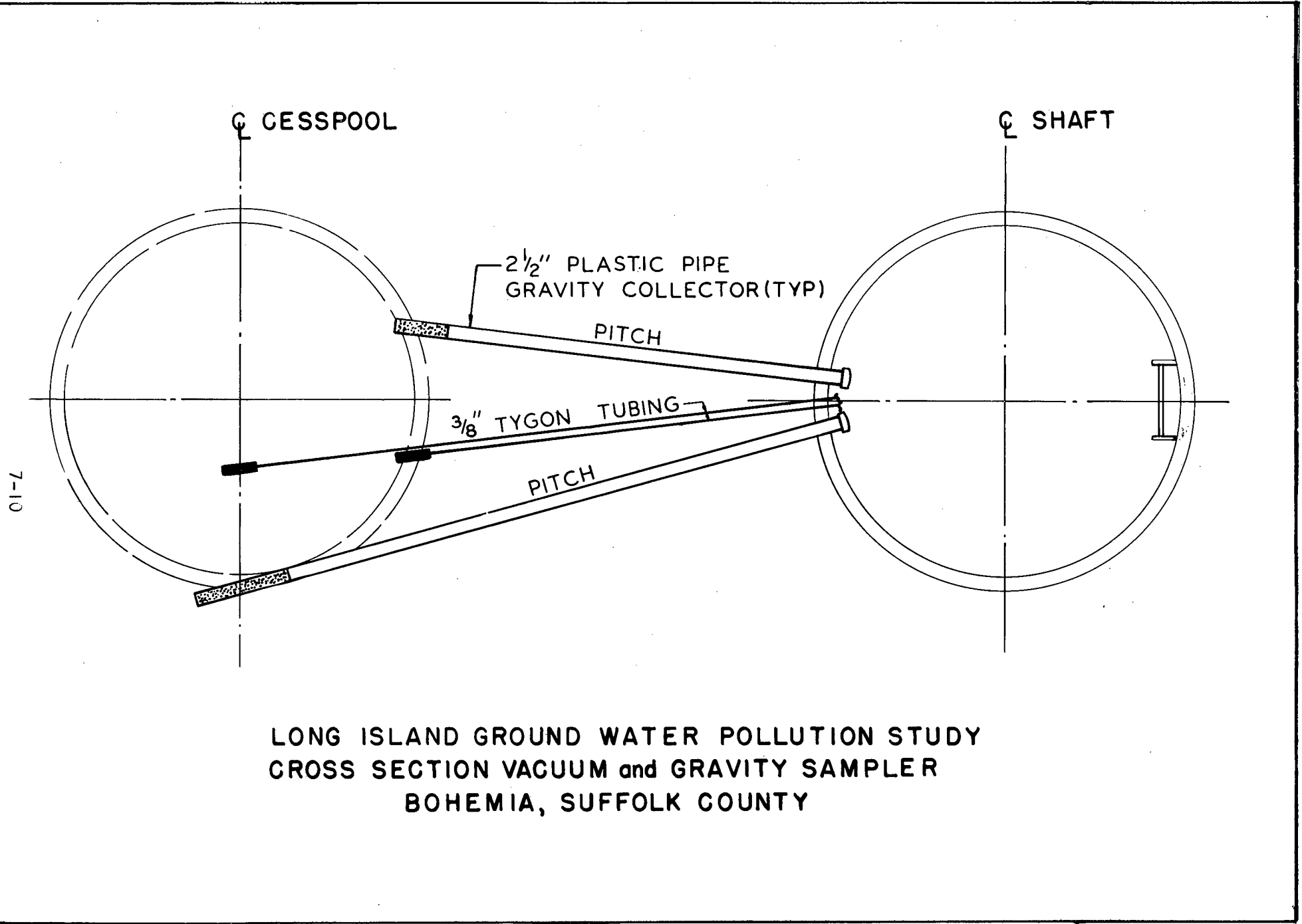

LONG ISLAND GROUND WATER POLLUTION STUDY
CROSS SECTION VACUUM and GRAVITY SAMPLER
BOHEMIA, SUFFOLK COUNTY

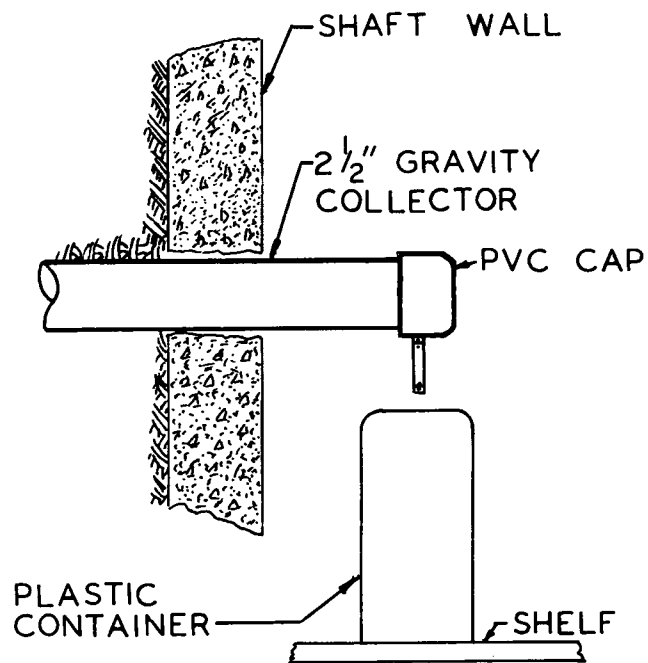
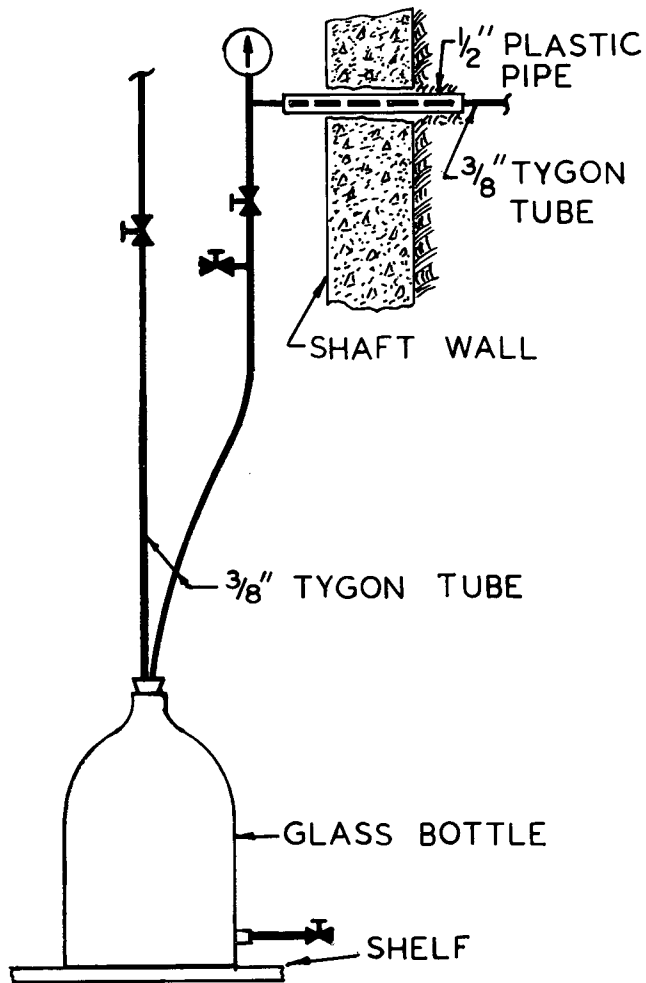
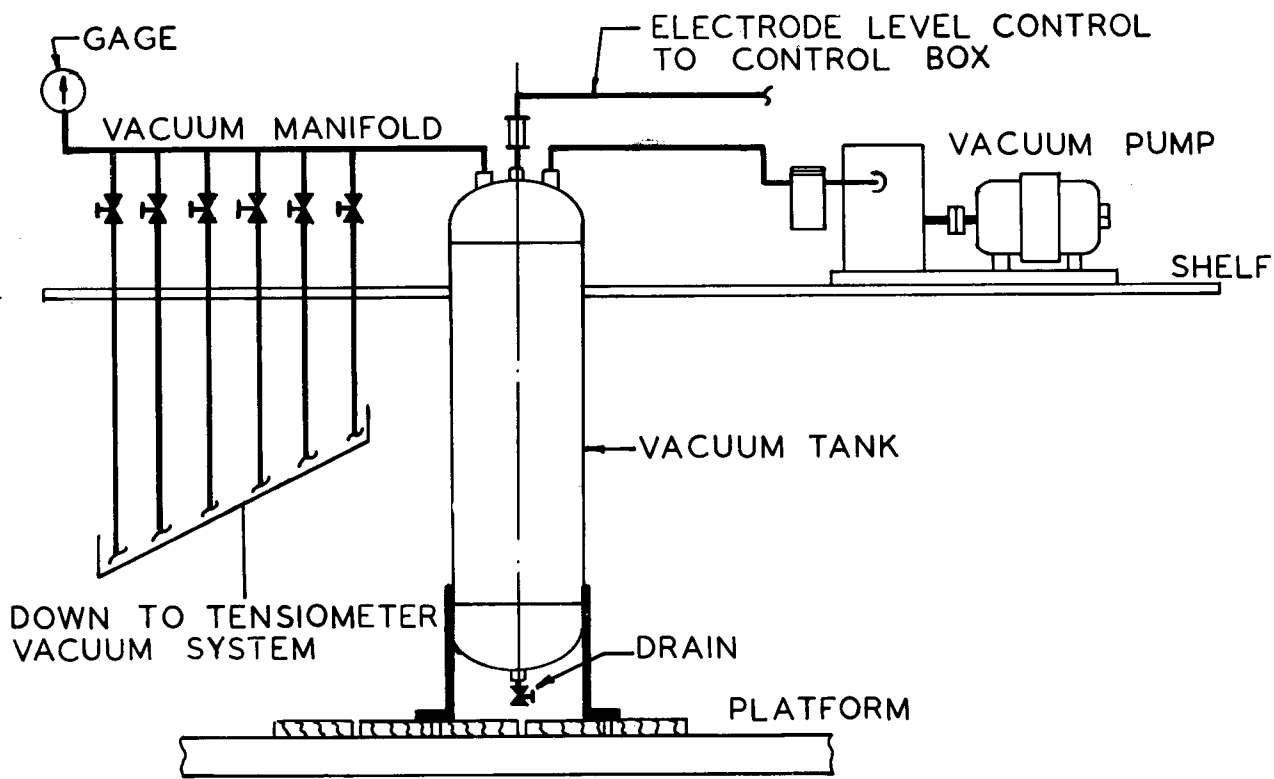

LONG ISLAND GROUND WATER
 POLLUTION STUDY
 SAMPLER TUBE DETAILS
 SITE 3. BOHEMIA,
 SUFFOLK COUNTY

a 4 inch steel sleeve to the predetermined locations under the pool. The gravity collector end was then packed with sand and gravel and inserted into the steel sleeve. The sleeve was then withdrawn to expose the sampling surface. Plastic pipe caps with a drain nipple were then installed to discharge into a sample collection vessel within the shaft.

The liquid volume produced by these units was insufficient for the required analyses. Various methods of increasing the yield were attempted including backflushing, vibration, and detonation of minor explosives all with relatively little success. It was postulated that the formation did not completely collapse around the sampler thereby eliminating a direct path of travel of the liquid film from the formation into the sampler.

Additional gravity sampling units were installed with a considerably larger open-surface area. This resulted in some improvement but sample volumes were still insufficient. The final gravity units were installed and constructed in a slightly different manner. These new units had tapered ends and the installation consisted of the placement of the steel sleeve to a point short of the final site of the sampler. The tapered point sampler was then inserted into the sleeve and driven into the natural undisturbed formation. This process assured intimate contact of the sampling device with the sands and eliminated the possibility of any minor cavern formation.

The tensiometer sampling devices used were of the Selas tube type. They were installed by means of the 2 inch steel sleeve and withdrawal procedure used on the gravity system. The 6 inch length tensiometers were connected to 3/8 inch plastic pipe and, in turn, connected to the vacuum system as shown on the drawings. Each unit was prewetted and then kept under constant vacuum by means of the automatic vacuum system. The sampling valve manifold was so arranged so as to be able to isolate any individual sample vessel without disturbing the vacuum on the rest of the system.

Due to low output, longer (12 inch) tensiometers were installed. It was believed that the greater surface area of the larger tensiometers would produce a higher total volume of sample. They were installed in a manner similar to that of the original and after wetting, produced a volume of liquid sufficient for the required analyses.

Since the gravity collectors and tensiometers gave widely varying quantities of waste water, it was conjectured that the flow path of the waste was to some extent fixed by the varying porosities of the subsoil around and below the cesspool. It was followed that if the sample collecting devices could be placed at the points of maximum soil moisture, maximum quantities of liquid waste could be obtained.

Soil Moisture Profiles

The U.S. Geological Survey furnished a subsurface moisture probe in order to obtain soil moisture profiles in the vicinity of the cesspool. The equipment provided was Model 19 Depth Moisture Gauge - Nuclear Chicago Corp.

The Model P-19 contains a radiation source which produces fast neutrons, and a detector which is only sensitive to slow neutrons. The detector creates an electrical pulse for each neutron it detects. As fast neutrons are emitted from the source within the probe, they move out through whatever substance is in the immediate surrounding vicinity; they are scattered, and a portion of them are reflected back into the detector portion of the probe. During their travel through the surrounding substance, the neutrons are slowed by the physical characteristics of the substance, or medium. The quantity of them which become "slow neutrons" depends primarily upon the moisture content of the substance. So, with a known rate of emitting fast neutrons, the number of slow neutrons detected per unit of time can be related to the concentration of moisture.

Actually, it is hydrogen which is responsible for changing fast neutrons into slow neutrons, and any material which contains hydrogen produces the

same effect. The chemical content of most soils is such that the primary hydrogen present is in the moisture contained in the soil. If the equipment is used in the vicinity of any other material which contains hydrogen, a background rate will be recorded.

Each probe is individually calibrated, and a set of calibration curves is furnished, with which the operator can interpret the relationship between the detected counting rate and the relative moisture concentration. The count rate is practically independent of grain structure and aggregation, so a single calibration curve can be used for most types of soil. In order to pass the probe through the soils to be analyzed, 1 3/4 inch diameter thin wall steel tubes were driven both vertically adjacent to and horizontally below the cesspool. (Figure 7-9)

The data obtained by the probe measurements conformed favorably with the computed moistures for soil types encountered. The moisture for the soils unaffected by the cesspool discharge varied from 8 to 10 percent. At a depth of 10 feet, the cesspool discharge caused moisture to increase to a range of 15 to 20 percent. Below the cesspool bottom, moistures decreased to 10 to 15 percent as measured in a vertical line one foot from the cesspool side wall, indicating that wastes leaving a cesspool do not travel any significant distance from the outside cesspool wall. At a distance of 2.5 to 3 feet above ground water table, moisture levels increased to a maximum of 35 percent, a value close to saturation for such soils. (Figure 7-10)

The horizontal measurements taken beneath the cesspool bottom confirmed the conclusions drawn from the vertical observations in that wastes leaving the cesspool remained within limits approximately one foot beyond the outside wall of the cesspool. The moisture content varied from 10 to 20 percent. Maximum moisture contents were near the outer walls of the cesspool. An apparently dry area (10 percent) was noted directly beneath the center of the cesspool. It is believed that the cesspool bottom is clogged early in its operation, and waste flow is predominantly from the cesspool side wall.

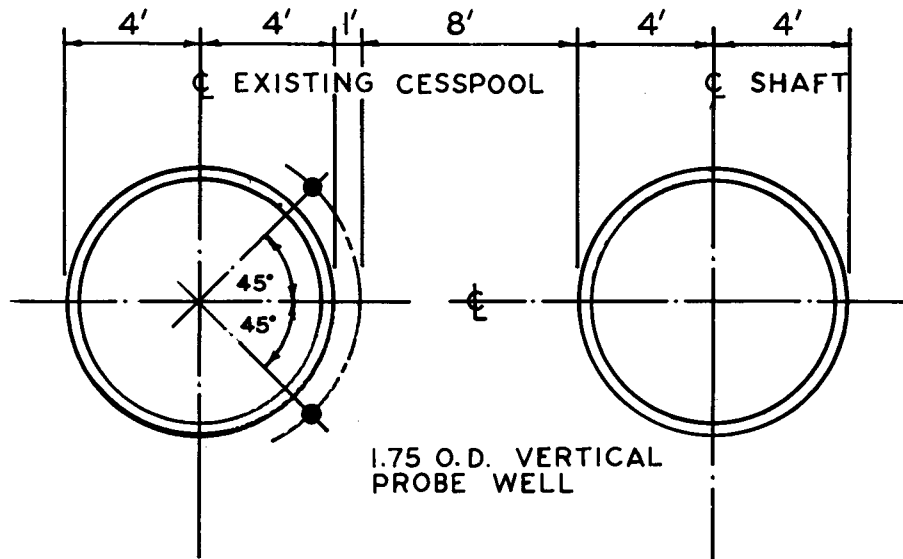

LOCATION PLAN VERTICAL PROBE

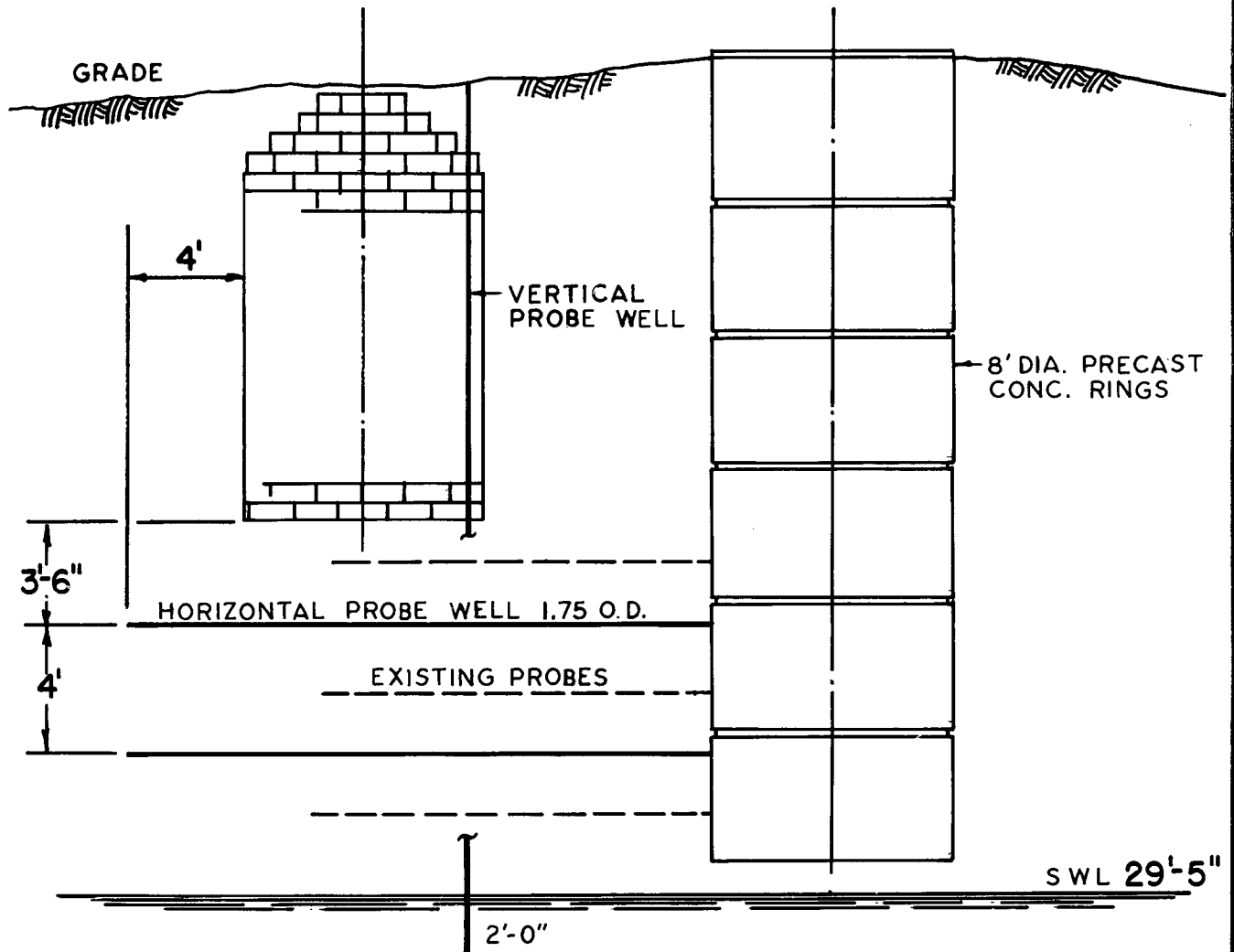

ELEVATION HORIZONTAL PROBE
LONG ISLAND GROUND WATER POLLUTION STUDY
NEUTRON PROBE WELLS
SITE 3. BOHEMIA, SUFFOLK COUNTY

LONG ISLAND GROUND WATER POLLUTION STUDY

VERTICAL & HORIZONTAL SOIL MOISTURE CONTENT (MARCH 1964)

SITE N° 3 - BOHEMIA, SUFFOLK COUNTY, N.Y.

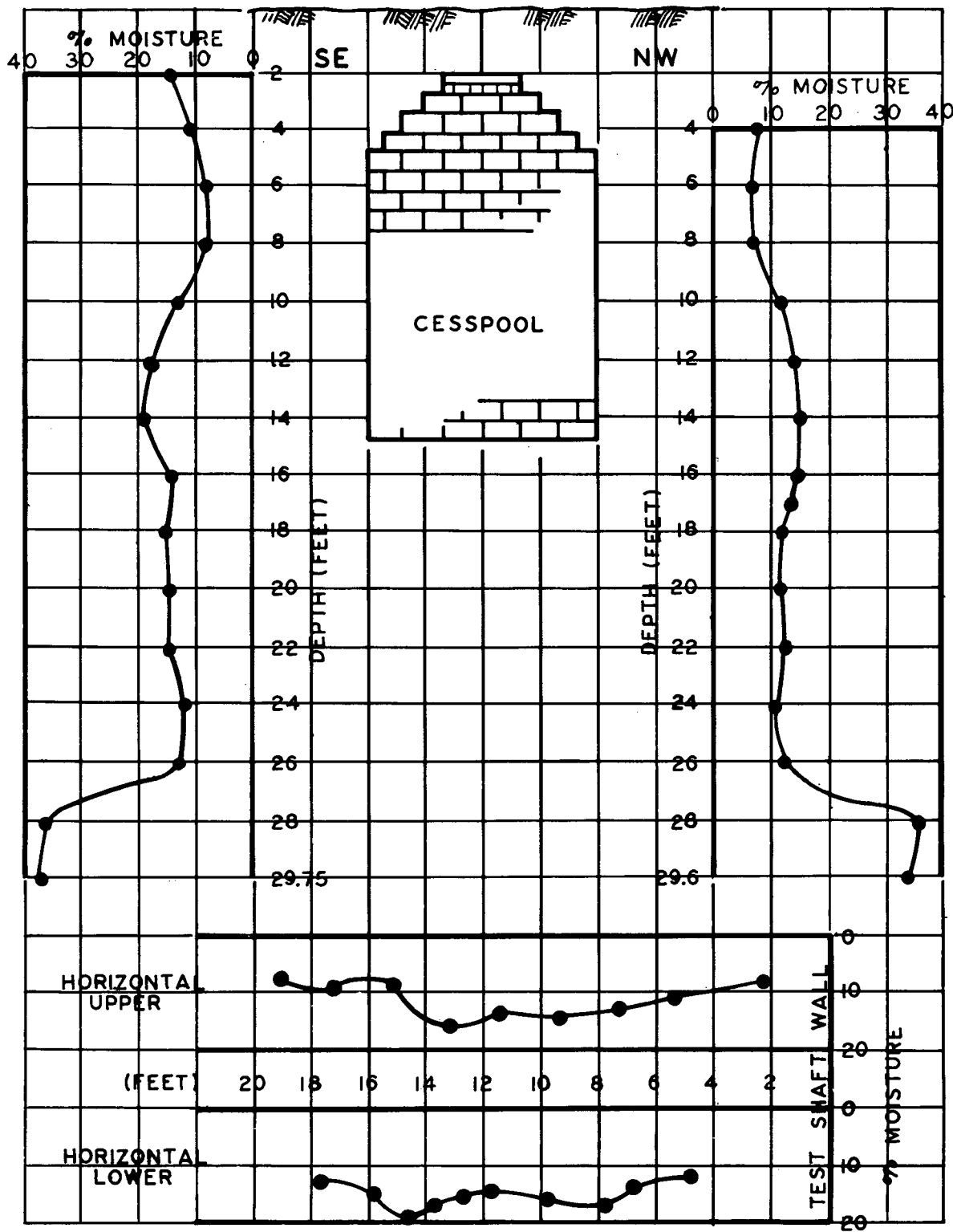

Upon analysis of the probe measurements, new gravity samplers were installed, and substantial increases in sample quantities were noted.

On November 13, 1964 three tracer wells were installed on Site No. 3. These were four-inch diameter PVC open-bottom tubes with the first 12" section drilled with 1/8 inch holes and set to a total depth of 31 feet or one foot six inches below static water level. The upgradient well was five feet north of the two interceptor wells spread on one-foot centers in order to insure contact with the tracer slug. A 4100 mg/l chlorine solution was introduced into the lead tracer well. Daily sampling was performed with messenger-operated, spring-loaded sampling tube. The chloride data on review indicated a ground water velocity of 0.6 feet per day.

Radioactive tag studies were carried out on Site No. 3 in order to confirm ground water velocity findings and to obtain further insight into surfactant degradation processes in the cesspool and saturated and unsaturated subsoils. The details and results of these studies are reported in Part 10.

Travel of Waste Slug

1. At the first downstream observation well group No. 6, the sewage slug was situated at approximately 2 feet below SWL. As the waste slug proceeded past the downstream sampling points, the location of peak concentrations of contaminants of sewage origin remained constant with respect of the ground water level; i.e., at 2 feet below SWL throughout all downstream wells.
2. Travel of the waste slug through approximately 17 feet of unsaturated sands and gravel reduced the density of the slug to a level where the density difference between the sewage slug and ground water was not sufficient to cause depression of the slug through the downstream flow path.
3. Natural recharge, by precipitation, did not appear to have any direct affect on either depressing the waste slug or resulting in additional dilution.
4. In travel through the downstream flow path, contaminants of sewage origin generally tended to decrease in overall concentration as a result of mixing

with less contaminated ground water, exchange and sorption processes.

5. Background observation wells did not indicate the presence of a sewage slug from upgradient pollutional sources.

Chlorides

1. Chloride concentrations in the disposal system averaged 64.5 and 57.0 mg/l during the use of ABS and Las, respectively. (Table 4-2) Background observation wells had an average chloride concentration of 5.3 mg/l. (Table 4-1)

2. Travel between the cesspool and first well group, unsaturated soil zone, resulted in chloride reductions of 17.9 and 23.5 percent during the use of ABS and LAS surfactants. (Table 7-2) The overall average rates of reduction in travel through the unsaturated soil zone (20 feet travel distance) were:

	<u>Average Values</u>	
ABS	0.90%/ft.	0.58 mg/l/ft.
LAS	1.17	0.67

Chlorides had the following reduction characteristics as the waste slug proceeded through the various sampling levels of the unsaturated zone:

	<u>Cesspool to Top Samplers (1.5' Travel Dist.)</u>	<u>Average Values Top to Middle Samplers (4.0' Travel Dist.)</u>	<u>Middle to Bottom Samplers (4.0' Travel Dist.)</u>
ABS	+1.33 mg/l/ft.	1.82 mg/l/ft.	0.75 mg/l/ft.
LAS	+1.40	0.65	0.70

Travel through the upper layers of the unsaturated sands resulted in increasing chloride concentrations at the top collectors. Top collection devices were located approximately 18 inches below the base of the cesspool.

3. In the saturated soil zone, (travel from first to last well groups) percent reductions of 14.0 and 26.5 percent resulted during the use of ABS and LAS, respectively. (Table 7-3 Figure 7-9, 10, 7-31-34) Average rates of reduction in this downstream flow path are shown in the following tabulation: (Page 7-24)

TABLE 7-1

SITE #3

OBSERVATION WELL CONCENTRATIONS

V = 0.60 ft./day

	Cesspool 0	#6 5'	#10 15'	#13 25'	#16 45'
1. ABS (MBAS)	40.0	16.4	14.6	13.8	11.1
Ammonia	90.3	27.9	28.6	27.7	19.7
Chlorides	64.5	53.0	54.3	50.2	45.6
Total PO ₄	88.3	49.5	53.5	43.0	24.7
Spec. Cond.	850.0	564.0	615.0	592.0	538.0
Alkalinity	423.0	30.0	31.2	35.4	23.9
Sulfates	34.2	36.4	37.0	35.7	40.5
Coliform	8.50x10 ⁶	239.0	66.6	34.3	24.8
(Log Avg.)					
Nitrite	0.02	0.17	0.12	0.15	0.26
Nitrate	0.10	58.0	64.5	61.0	53.5
COD	191.0	65.6	84.0	87.2	41.2
2. LAS (MBAS)	29.2	12.6	13.2	16.8	6.3
Ammonia	83.5	26.5	21.2	25.0	12.4
Chlorides	57.0	43.6	45.0	42.0	32.0
Total PO ₄	66.5	15.6	22.2	14.6	1.5
Spec. Cond.	815.0	590.0	440.0	394.0	
Alkalinity	450.0	126.0	24.0	120.0	72.0
Sulfates	10.8	22.0	16.6	19.2	13.5
Coliform	16.46x10 ⁶	202.0	36.8	36.1	85.7
(Log Avg.)					
Nitrite	0.02	0.45	0.25	0.14	0.32
Nitrate	0.19	35.7	52.2	40.2	43.0
COD					

TABLE 7-2

SITE #3

TEST SHAFT CONCENTRATIONS

	Top				Middle				Bottom			
	TI	Ts	GL	GxL	TI	Ts	GL	GxL	TI	Ts	GL	GxL
1. ABS (MBAS)	20.5		17.5		16.7	16.5	26.8		9.2	12.8		
Ammonia	145.0				24.5		41.8		26.2	28.4		
Chlorides	66.5				62.0	59.0	58.6		55.0	57.5		
Total PO ₄	51.7				43.0	27.2	74.3		37.2	38.5		
Nitrate	0.21				104.0		91.0		116.5	95.0		
2. LAS (MBAS)	13.6					23.5	20.7		7.8			18.4
Ammonia												
Chlorides	60.5		57.7				56.5					53.7
Total PO ₄	31.8						75.0			40.0		
Nitrate												

PERCENT REMAINING OF CESSPOOL CONCENTRATIONS

	Top				Middle				Bottom			
	TI	Ts	GL	GxL	TI	Ts	GL	GxL	TI	Ts	GL	GxL
1. ABS (MBAS)	51.4		43.9		41.8	41.4	67.0		23.0	31.9		
Ammonia	+60.5				27.0		46.4		29.0	31.5		
Chlorides	+ 3.1				96.1	91.5	90.9		85.3	89.1		
Total PO ₄	65.3				48.7	30.8	84.1		42.0	43.5		
2. LAS (MBAS)	45.5					80.5	70.9	26.7				63.0
Ammonia												
Chlorides	+ 6.1		1.2				99.1					94.2
Total PO ₄	48.0						+12.8			60.0		

TABLE 7-3

SITE #3

PERCENT REMAINING OF FIRST WELL CONCENTRATION

	#6 0	#10 10'	#13 20'	#16 40'
1. ABS (MBAS)	100.0	89.0	84.2	67.7
Ammonia		+102.5	99.3	70.4
Chlorides		+102.5	94.7	86.0
Total PO ₄		+108.1	86.9	50.0
Spec. Cond.		+109.1	+105.0	95.4
Alkalinity		+104.0	+118.0	79.7
Coliform		28.0	14.0	10.5
(Log Avg.)				
COD		+128.0	+132.9	62.8
2. LAS (MBAS)	100.0	+104.8	+133.0	50.0
Ammonia		80.0	94.3	46.8
Chlorides		+103.2	96.3	73.5
Total PO ₄		+142.2	93.6	10.0
Spec. Cond.		74.6	66.8	
Alkalinity		15.0	95.2	57.0
Coliform		18.0	17.5	42.0
(Log Avg.)				
COD				

LONG ISLAND GROUND WATER POLLUTION STUDY
 REDUCTION VERSUS TRAVEL TIME
 CHLORIDES (9/16/1963 - 1/24/1966)
 SITE N° 3 - BOHEMIA, SUFFOLK COUNTY, N. Y.

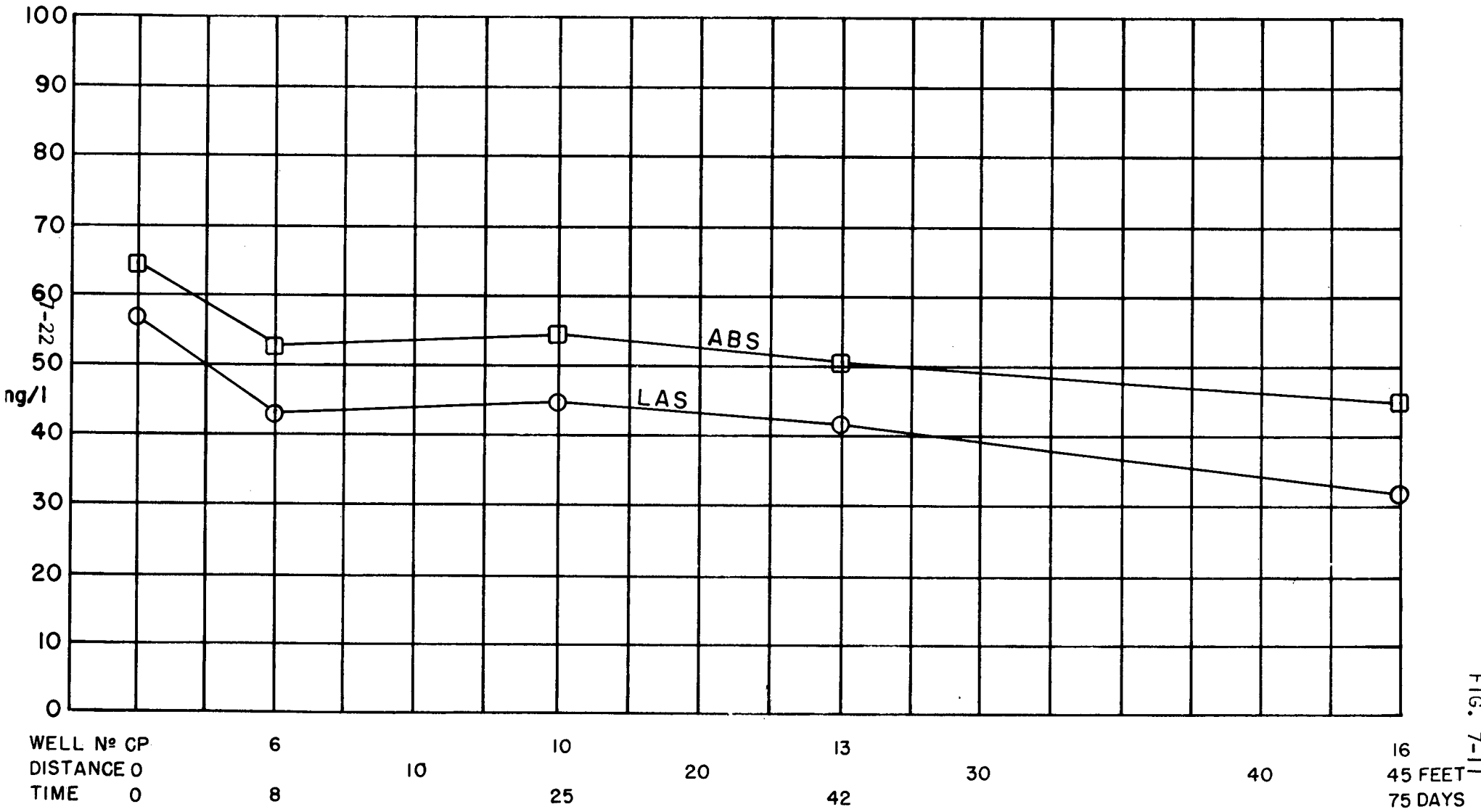

FIG. 7-11

LONG ISLAND GROUND WATER POLLUTION STUDY
 PERCENT REMAINING OF FIRST WELL CONCENTRATION
 CHLORIDES (9/16/1963 - 1/24/1966)
 SITE N° 3 - BOHEMIA, SUFFOLK COUNTY, N. Y.

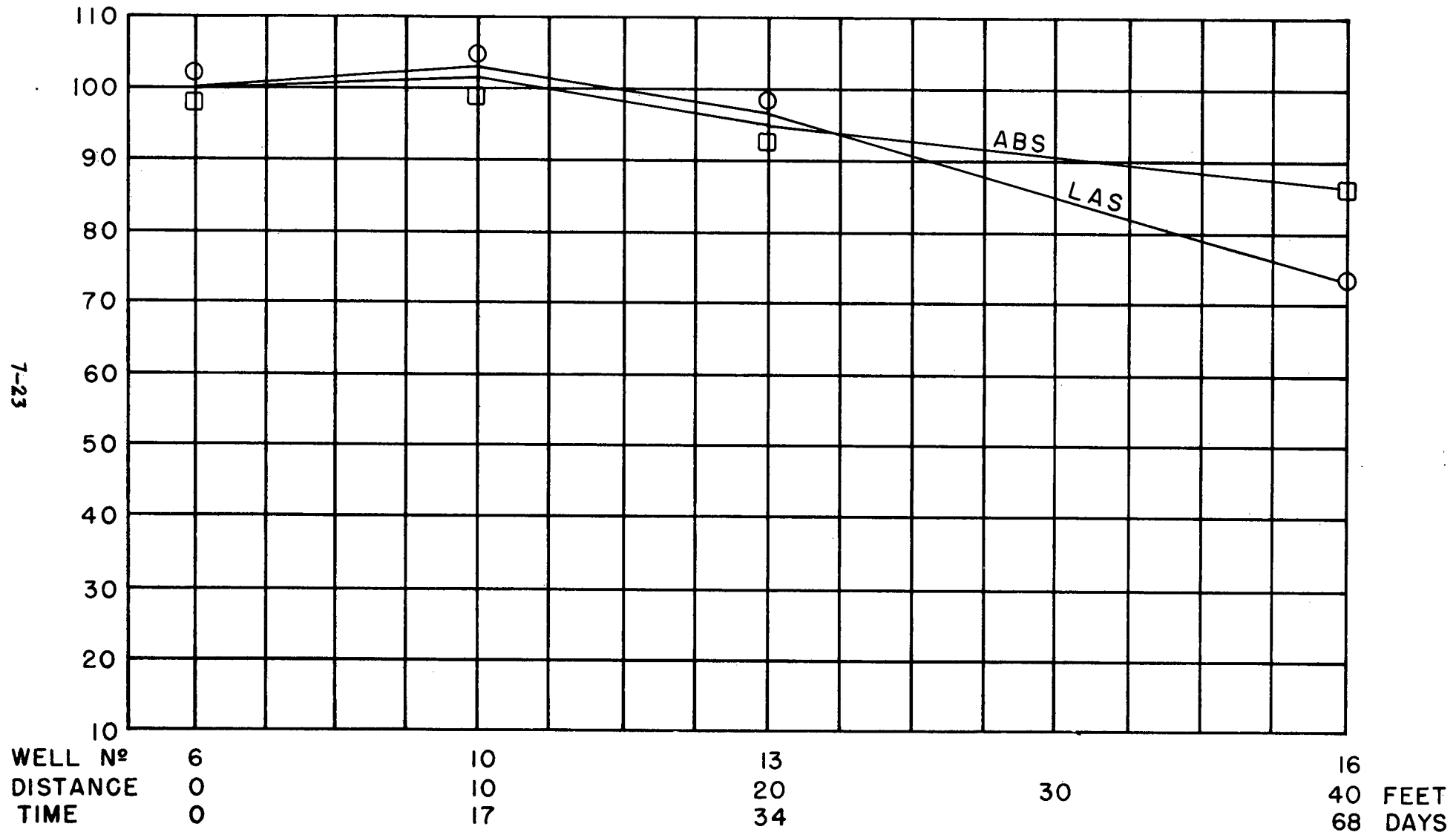

FIG. 7-12

Average Rates of Reduction

ABS	0.35%/ft.	0.21%/day	0.185 mg/l/ft.
LAS	0.67	0.40	0.29

Least Squares

ABS	0.41%/ft.	0.25%/day	0.23 mg/l/ft.
LAS	0.05	0.03	0.46

The two-fold increase in the average rate of reduction of chlorides during the use of LAS surfactant may be explained to some extent by increased water usage during LAS use. Reductions in the chloride concentrations in the saturated zone are generally accomplished by dilution with ground waters containing lower chloride concentration.

4. Average chloride reduction rates were significantly larger in the vertical travel through the unsaturated soil zone during the use of both LAS and ABS. Since dilution was negligible in the unsaturated soil zone, the reduction in chloride concentration must be due wholly to sorption and/or other processes rather than dilutional effects.

Infrared Analysis

1. Infrared analysis for the percent branched material, ABS, in the unsaturated and saturated soil zones indicated between 83 and 100 percent ABS still present in the soil. Infrared samples were first collected during the use of LAS surfactant, approximately six months after ABS was discontinued as the household washing compound. Prior to the study, the household was using an ABS surfactant as the washing material and; therefore, it is assumed that the downstream flow path was saturated with ABS material.

2 Average percent branched material present in the cesspool, unsaturated and saturated soil zones, during the use of LAS surfactant was:

<u>Sample Date</u>	<u>Cesspool</u>	<u>Top Gravity Sampler</u>	<u>Well #6 5'</u>	<u>Well #10 15'</u>	<u>Well #13 25'</u>
7/16/65	10%		95%	100%	100%
10/13/65	0	85%	83		85
11/13/65	0		86	96	89

<u>Sample Date</u>	<u>Cesspool</u>	<u>Top Gravity Sampler</u>	<u>Well #6 5'</u>	<u>Well #10 15'</u>	<u>Well #13 25'</u>
12/8/65	5		90	83	99

3. Sludge samples collected from the cesspool, 11/29/65, approximately 10 months after ABS was discontinued as the washing compound indicated an average of 25 percent branched material, ABS, present in the sludge material.

4. With increased time, since ABS surfactant usage, the branched material in the liquid phase of the cesspool decreased from 10 percent to 0 percent. Aeration of the cesspool November 1965 resulted in a resuspension of sludge material and increased the amount of branched material in the liquid phase to 5 percent.

5. At the top gravity sampler in the unsaturated zone, 18 inches below the bottom of the cesspool, 85 percent branched material, ABS, was still present 10 months after ABS was discontinued as the washing compound .

6. About 75 days (2.5 months) was required for ground water to completely pass through the downstream, saturated zone, sampling locations. Infrared samples were collected only as far downstream as well No. 13 or approximately 42 days (1.5 months) travel time. Since ABS surfactant was discontinued (6-11 months) as the household washing compound, approximately 4-7 complete waste slug passages occurred. Despite the relatively large amount of flushing 85-100 percent branched material, ABS, still persisted at well No. 13, 25 feet downstream from the disposal system.

7. Composite soil core extract samples collected at various depths approximately one foot off the cesspool wall had the following percent branched material present:

Composite #1	(11/9/65)	100% branched
Composite #2	(9/6/65)	99% branched
Composite K.L. M		35% branched

8. Branched material, present at the various sampling locations, increased downstream indicating adsorption of ABS rather than desorption. The increase in branched material resulted even after 4-7 complete passes of the waste slug through the downstream system after ABS was discontinued as the household washing material.

MBAS as ABS

1. In the disposal system, the concentration of MBAS reported as ABS averaged 40.0 and 29.2 mg/l during the use of ABS and LAS, respectively. (Table 7-1)
2. Vertical travel of the waste slug through the unsaturated soil zone, cesspool to first well group, resulted in overall reductions in MBAS concentrations of 59.0 and 57.0 percent during the use of ABS and LAS surfactants, respectively. (Table 7-2, 3) Average rates of MBAS reduction through the entire unsaturated zone (20 feet travel distance) were:

Average Values

ABS	2.95%/ft.	1.18 mg/l/ft.
LAS	2.86	0.83

3. MBAS reduction characteristics varied as the waste slug proceeded through the various sampling levels of the unsaturated zone and also with each sample collecting device. Generally, MBAS levels decrease to the top samplers, then increase and decrease in concentration at the middle and bottom samplers, respectively.
4. At the top samplers located 18 inches below the base of the cesspool, average MBAS levels were reduced 52.3 and 54.5 percent during the use of ABS and LAS surfactants, respectively. It is apparent that reductions in MBAS concentrations occurred primarily during the first 18 inches of travel below the bottom of the cesspool.
5. Passage from the top samplers to the first well group (remainder of unsaturated zone, 18.5 feet travel distance) resulted in MBAS reduction rates of:

Average Values

ABS	0.75%/ft.	0.14 mg/l/ft.
LAS	0.40	0.054

- ABS was reduced in the unsaturated zone at about twice the rate of the LAS surfactant.
6. Since the reduction in chloride concentrations in the unsaturated zone is

primarily due to sorption and/or other processes because of the improbability of dilution occurring beneath the cesspool, MBAS reduction must then be attributed to factors other than dilution.

7. Movement of the waste slug in the saturated downstream flow path (first to last well groups) resulted in an additional 32.3 and 50.0 percent reduction during the use of ABS and LAS. (Table 7-1, 3 Figure 7-13, 14)

8. Average rates of MBAS reduction through the downstream sampling locations (40' travel distance) were:

	<u>Average Values</u>		
ABS	0.80%/ft.	0.48%/day	0.13 mg/l/ft.
LAS	1.25	0.75	0.16

9. Compensating for dilutional effects, based upon reductions in chloride concentrations, resulted in net MBAS rates of reduction (% MBAS - % Chlorides) of:

	<u>Average Values</u>	
ABS	0.45%/ft.	0.27%/day
LAS	0.58	0.35

The above values indicate that approximately 50 percent of MBAS reduction is due to dilution.

10. Travel from the cesspool to the first well group (20 feet vertical distance) resulted in a 99.9 percent reduction in the coliform population. (Table 7-1, 3 Fig. 7-23; 7-31 thru 34) In this same travel path, MBAS reductions were only 59 percent (ABS) and 57 percent (LAS). From this data, it may be inferred that there is no significant connection between MBAS levels and the travel of the coliform organism. This inference is drawn upon the assumption that if MBAS influenced coliform travel the reduction rates of MBAS and coliform would more closely parallel each other.

Radioactive Tagging Study

Phase I

LONG ISLAND GROUND WATER POLLUTION STUDY
 REDUCTION VERSUS TRAVEL TIME
 MBAS REPORTED AS ABS (9/16/1963 - 1/24/1966)
 SITE N° 3 - BOHEMIA, SUFFOLK COUNTY, N. Y.

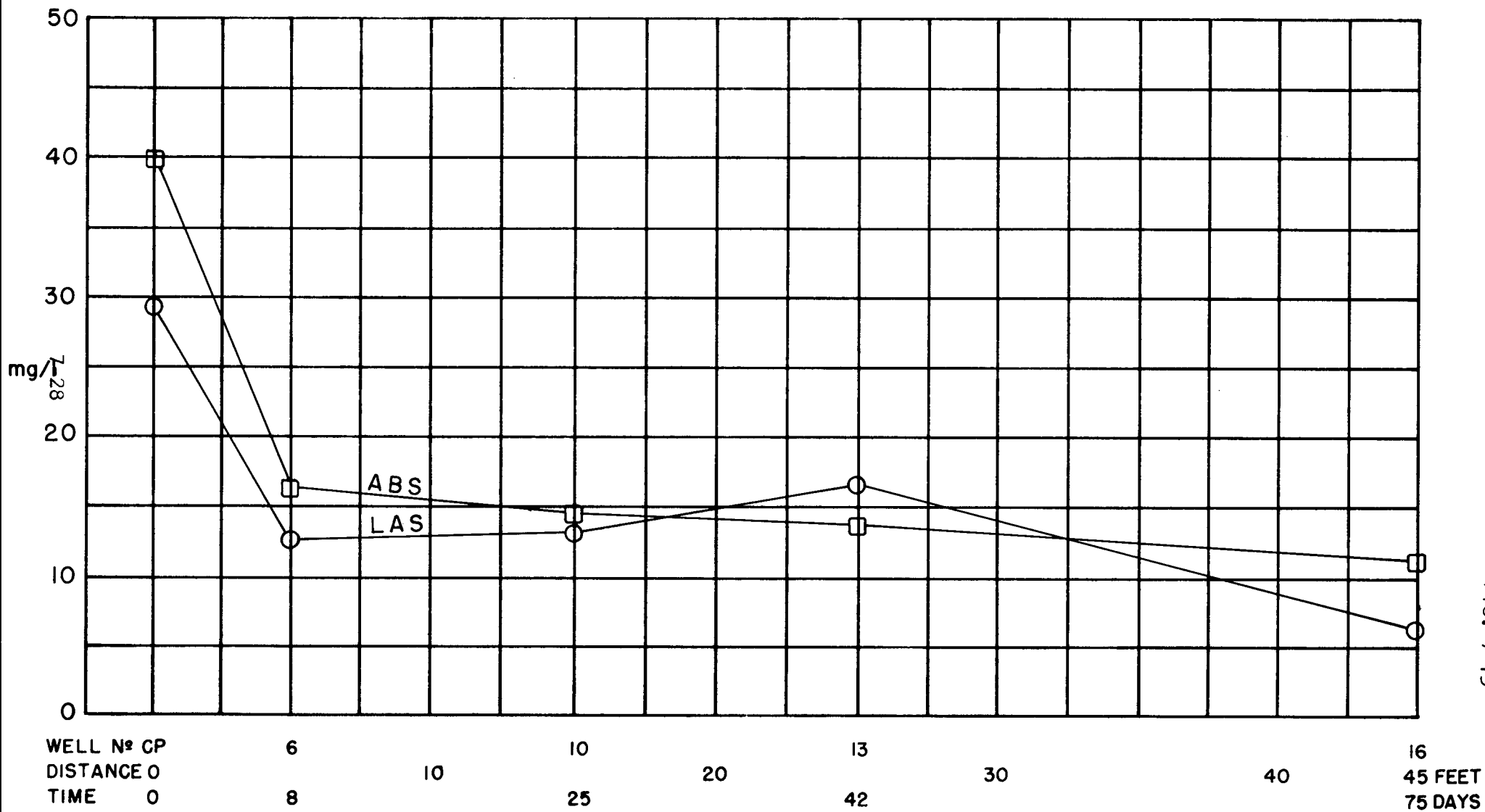

FIG. 7-13

LONG ISLAND GROUND WATER POLLUTION STUDY
 PERCENT REMAINING OF FIRST WELL CONCENTRATION
 MBAS REPORTED AS ABS (9/16/1963 - 1/24/1966)
 SITE N° 3 - BOHEMIA, SUFFOLK COUNTY, N. Y.

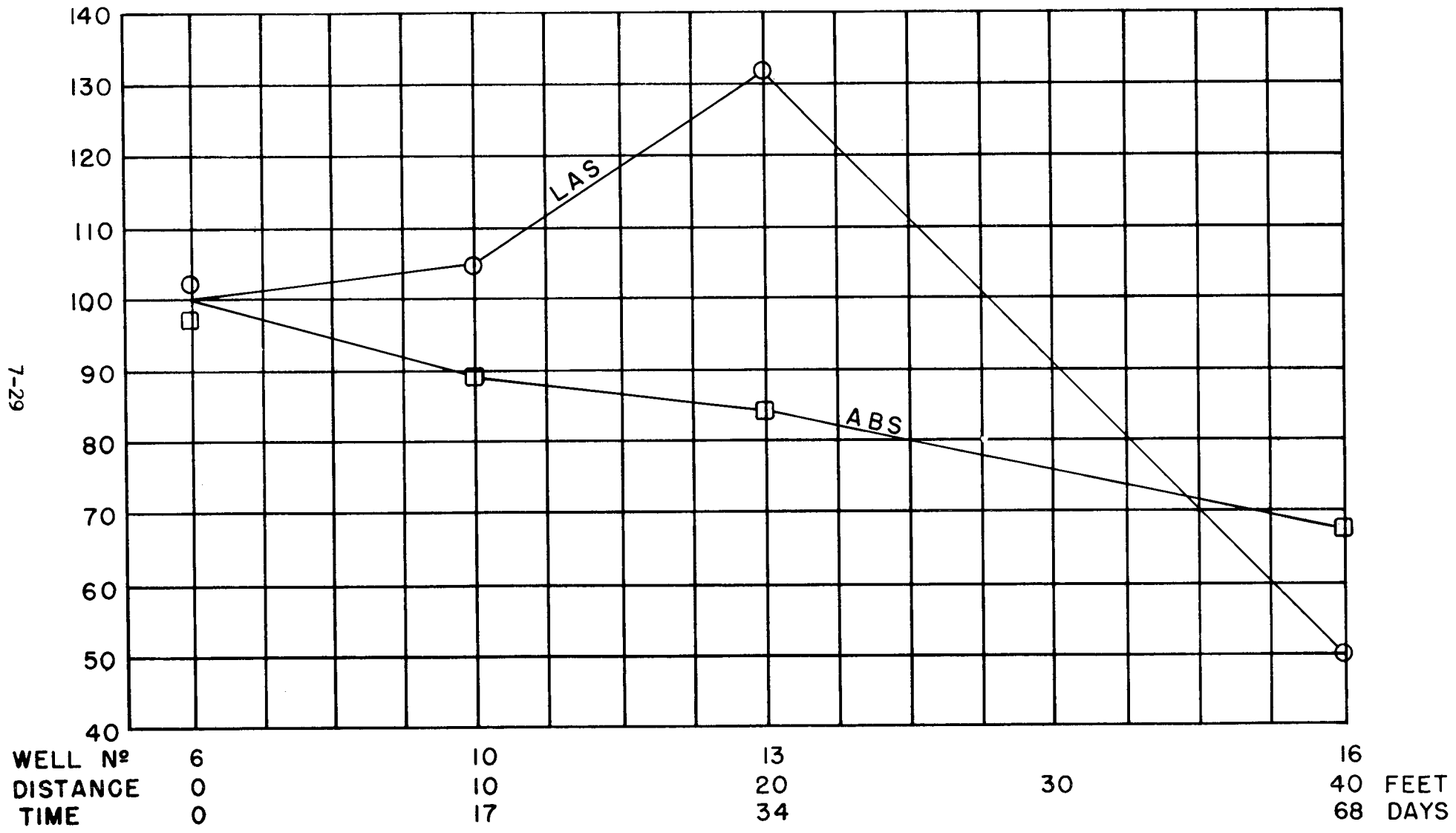

FIG. 7-14

1. Phase 1 study consisted of a single application of radioactive tagged materials, tritium and sulfur-35, introduced into the disposal system on May 11, 1965. (Table 7-4) Samples to be analyzed for tritium and sulfur activities were collected from the cesspool and downstream sampling locations for a period of 3 to 6 weeks.
2. Peak tritium and sulfur activities moved through the entire flow path essentially as a slug.
3. Activity levels increased rapidly at each sampling point to a peak concentration, then decreased in activity at a gradual rate. Dispersion and dilution of the slug resulted in the buildup of activity levels which were less distinct at each succeeding downstream well group. (Table 7-4)
4. Velocities, based upon movement of tagged material at maximum concentrations, in the unsaturated and saturated soil zones, varied greatly. Incremental and overall average velocities, based upon peak tritium activities, were:

Unsaturated Zone (20 feet vertical travel) -

Cesspool to Top Sampler	0.75 ft./day
Top to Middle Sampler	1.33
Middle Sampler to Well #6	1.60
Cesspool to Middle Sampler	1.10
Cesspool to Well #6	<u>1.15</u>
Average Velocity	1.26 ft./day (based on total single values)

Saturated Zone -

Well #6 to #10 (10' travel)*	0.91 ft./day
Well #10 to #13 (10' travel)	5.0
Well #6 to #13 (20' travel)*	<u>1.54</u>
Average Velocity *	1.23 ft./day

5. It was not possible to detect when activity first arrived at each downstream sampling point from the cesspool. Velocities based upon initial arrival of tagged material would have resulted in ground water velocities somewhat

TABLE 7-4
SUMMARY DATA
PHASE I - RADIOACTIVE TAG STUDY
SITE #3

Single application (Dose) - May 11, 1965

Location	Date of Peak Activity	Peak Activities uc/ml			Ratio		% Degradation	Dilution Factor		MBAS Level During Phase I (LAS) mg/l
		H x 10 ⁻³	T.S x 10 ⁻⁴	U.S x 10 ⁻⁵	T.S/U.S	H./T.S		H.	T.S	
Cesspool	5/11/65	12.5	28.6	324.0	0.88	4.37	0	--	--	28.6
TTL	5/13	4.25	1.74	8.9	1.98	24.4	48.8	2.94	16.4	9.7
MGL	5/16	4.91	2.03	11.4	1.78	24.2	43.6	2.54	14.1	18.5
Well #6*	5/29,5/25	2.50	2.60	5.5	4.73	9.60	79.0	5.00	11.0	12.1
#10	6/5	3.20	2.90	6.69	4.35	11.0	77.0	3.90	9.85	24.0
#13	6/7	1.34	0.761	1.71	4.45	17.6	77.4	9.35	37.5	23.6
#17	Not Defined									9.7

*Estimated

$$\% \text{ Degradation} = \frac{\text{Total Sulfur Activity} - \text{Undegraded Sulfur Activated}}{\text{Total Sulfur Activity}} \times 100$$

$$\text{Dilution Factor} = \frac{\text{Peak Cesspool Activity}}{\text{Peak Activity at a Given Sampling Location}}$$

greater than movement based upon peak tritium activities.

6. Water use in the household ranged from 12 to 60 cubic feet per day. To reduce the daily volume, variation water was added to the disposal system assuring a minimum daily flow to the cesspool of about 30 cubic feet.

7. Within the disposal system, tritium and sulfur activities decreased at a relatively constant rate until increasing water levels indicated imminent overflow of the cesspool system. (Table 7-5)

8. Total and undegraded sulfur peak activity levels in the disposal system indicated that no degradation of the tagged LAS-35 occurred in the liquid portion of the cesspool.

9. No preferential holdup of tritium, total or undegraded sulfurs was observed in the cesspool or downstream sampling locations.

10. Reasonably consistent ratios of total to undegraded sulfur-35 at each sampling location in the unsaturated and also the saturated zone indicated what appeared to be degradation rather than some other process. (Table 7-4)

11. Degradation of the LAS-35 molecule occurred at the interface between the cesspool and unsaturated zone and also between the unsaturated and saturated soil zones. Percent degradation during the Phase I study in comparison to the average percent reductions of the cesspool MBAS concentrations were:

Percent Reduction of Cesspool
MBAS Levels

	<u>Percent Degradation</u>	<u>ABS</u>	<u>LAS*</u>	<u>LAS (Phase I)</u>
Cesspool	---	0	0	0
Top Sampler	48.8	52.3	54.5	66.0
Middle Sampler	43.6	50.0	40.8	35.3
Well #6	79.0	59.0	57.0	57.6
Well #10	77.0	63.5	54.6	16.1
Well #13	77.4	65.5	42.5	17.5
Well #16		72.3	78.4	66.0

TABLE 7-5

SUMMARY DATA
 PHASE I - RADIOACTIVE TAG STUDY

% Reduction of Cesspool Activity
 (Peak Activities)

	Tritium	Total Sulfur	Undegraded Sulfur
Cesspool	0	0	0
TTL	66.0	94.0	97.3
MGL	60.6	92.7	96.4
Well #6	80.0	91.0	98.3
#10	74.5	89.8	98.0
#13	89.3	97.1	99.3
#17			

% Reduction of Cesspool MBAS Conc.

ABS	LAS	LAS (Phase I only)
0	0	0
52.3	54.5	66.0
50.0	40.8	35.3
59.0	57.0	57.6
63.5	54.6	16.1
65.5	42.5	17.5
72.3	78.4	66.0

% Reduction of Well #6 Peak Activity

	H	T.S	U.S
Well #6	0	0	0
#10	+28.0	+11.5	+21.6
#13	46.5	70.6	69.0
#17			

% Reduction of Well #6 Conc.

ABS	LAS	LAS (Phase I)
0	0	0
11.0	+4.8	+99.8
15.8	+33.0	+95.0
32.3	50.0	19.8

Average Rate of Reduction (Tritium)

Well #6-#13 (20') 2.32%/ft., 1.39%/day

Average Rate of Reduction (Chlorides)

ABS Well #6-#16 0.35%/ft., 0.21%/day

LAS Well #6-#16 0.67%/ft., 0.40%/day

*Average percent MBAS reduction during the entire time period for which ABS and LAS was used as the household washing compound.

12. No degradation of the tagged LAS-35 was observed in movement of the slug through the saturated soil zone. (Table 7-4, 5)

13. Significant overall reductions in tritium and sulfur peak activities resulted. Sulfur-35 and tritium reductions occurred in the first 18 inches of travel in the unsaturated soil zone, but additional reduction of tritium resulted in the saturated zone flow path.

Percent Reduction of Cesspool Peak Activities

	<u>Tritium</u>	<u>Total Sulfur</u>	<u>Undegraded Sulfur</u>
Cesspool	0	0	0
Top Sampler	66.0	94.0	97.3
Middle Sampler	60.6	92.7	96.4
Well #6	80.0	91.0	98.3
Well #10	74.5	89.8	98.0
Well #13	89.3	97.1	99.3

14. Increases in tritium, total and undegraded sulfur activities at well No. 10, in the saturated soil zone indicates the possibility of the waste slug center missing the bottom collectors and well No. 6 thus accounting for generally lower activity levels.

15. Dilutional effects as measured by changes in peak tritium levels indicated a rate of reduction or dilution of about 4.0%/ft. in the unsaturated zone (cesspool to well No. 6) and 2.32%/ft. through the saturated zone (Well No. 6 to No. 13). Rates of reduction, dilution, based upon peak tritium levels, were significantly greater than observed chloride reductions. (Table 7-5)

Rates of Reduction (Dilution)

	<u>Unsaturated Zone</u>	<u>Saturated Zone</u>
Tritium (LAS usage)	4.00%/ft.	2.32%/ft.

Chlorides (ABS usage)	0.90%/ft.	2.32%/ft.
Chlorides (LAS usage)	1.17	0.67

16. The dilution factor (peak cesspool activity/peak activity at a given sampling point) is a direct measure of the water dilution factor. Based upon changes in tritium activities, the dilution factor remained relatively constant in the unsaturated zone (2.54 to 2.94), but varied in the saturated zone (3.9 to 9.35). (Table 7-4)

17. In general, the only factors causing tritium and chloride levels to decrease is dilution. Dilution factors based upon tritium suggested much greater dilution than indicated by chlorides.

Dilution Factors

Cesspool Concentration
Sampling Point Concentration

	<u>Tritium</u>	<u>ABS</u>	<u>Chlorides</u> <u>LAS</u>
Cesspool	0	0	0
Top Samplers	2.94	0.97	0.96
Middle Samplers	2.54	1.08	1.01
Bottom Samplers	---	1.15	1.06
Well #6	5.00	1.21	1.30
Well #10	3.90	1.19	1.26
Well #13	9.35	1.28	1.35
Well #16	---	1.40	1.78

Cognizance must be made that the peak tritium activities were not steady state conditions and appreciable error may have resulted due to dilution by the waste slug itself.

Phase II

1. Phase II study entailed the continuous application of radioactive tagged materials, tritium and sulfur-35, into the disposal system beginning September

29, 1965. Samples were collected from downstream sampling locations from September 29 through December 8, 1965, for radioactive levels as well as other constituents. (Table 7-6)

2. Equilibrium or quasi-steady state conditions, with respect to activity levels, were established and maintained with the disposal system and at each downstream sampling location for several weeks.

3. Determination of an accurate slug and ground water velocity based upon initial arrival of peak tritium activities in the unsaturated and saturated soil zones resulted in extremely erratic rates: (Table 7-6)

Unsaturated Zone -

Cesspool to Top Sampler	1.66 ft./day
Cesspool to Middle Sampler	0.55
Top to Middle Sampler	0.0
Cesspool to Well #6	1.25

Saturated Zone -

Well # 6 to #10 (10' travel)	0.385 ft./day
Well #10 to #13 (10' travel)	0.0
Well #6 to #13 (20' travel)	0.193

4. Velocities based upon the first indication of tritium activity, resulting from the continuous dosage of the Phase II study, could not be determined. This was due to the inability of accurately distinguishing the initial tritium arrival date at the downstream sampling locations.

5. During steady state conditions no degradation of the tagged LAS-35 resulted in the liquid portion of the cesspool. (Table 7-6)

6. There was no observed preferential holdup of tritium, total or undegraded sulfurs in the disposal system or downstream observation wells.

7. Sampling locations downstream from the disposal system required a significantly longer time period to achieve peak activity levels than during the Phase I study. (Tables 7-4, 6)

TABLE 7-6

SUMMARY DATA
 PHASE II- RADIOACTIVE TAG STUDY
 SITE #3

First Application (Dose) - September 29, 1965

Location	Dates (Quasi-Steady State)	Average Activity Steady State $\mu\text{c}/\text{ml}$			Ratio		Average % Degradability	Dilution Factor		MBAS Level Dur- ing Phase II LAS-mg/l
		H $\times 10^{-3}$	T.S $\times 10^{-5}$	U.S $\times 10^{-5}$	T.S/U.S	H/T.S		H.	T.S	
Cesspool	9/30/65-10/8	1.20	24.30	27.80	0.875	4.6	0	-	-	22.6
Top Gravity	10/8-11/13	1.13	3.92	2.38	1.65	28.9	39.4	1.06	6.20	6.7
Middle Gravity	10/9-11/17	1.16	2.90	1.57	1.84	40.0	46.0	1.04	8.38	5.5
7-57 Bottom Gravity	11/2-12/31	1.10	2.44	1.16	2.10	45.1	52.5	1.09	9.95	7.7
Well #6	10/16-10/30	1.02	3.46	1.12	3.09	29.5	67.2	1.18	7.02	9.8
	11/19-12/8	0.37	2.26	1.21	1.86	16.4	46.5	3.24	10.07	
Well #10	11/11-12/6	0.87	4.37	2.02	2.16	19.9	53.6	1.38	5.56	3.0
Well #13	11/11-12/18/65	0.74	2.36	1.50	1.57	31.3	36.4	1.62	10.03	4.1

$$\% \text{ Degradation} = \frac{\text{Total Sulfur Activity} - \text{Undegraded Sulfur Activity}}{\text{Total Sulfur Activity}} \times 100$$

$$\text{Dilution Factor} = \frac{\text{Peak Cesspool Activity}}{\text{Peak Activity at a Given Sampling Location}}$$

8. Relatively constant ratios of total to undegraded sulfur activities at each observation point indicated what appeared to be degradation rather than some other process. (Table 7-6)

9. Degradation of the LAS-35 molecule occurred throughout the entire unsaturated soil zone prior to the first downstream well No. 6. Percent degradation and average percent reductions of cesspool MBAS concentrations were as follows:

Percent Reduction of Cesspool

	<u>Percent Degradation</u>	<u>MBAS Concentrations</u>		
		<u>ABS</u>	<u>LAS*</u>	<u>LAS (Phase II)</u>
Cesspool	0	0	0	0
Top Sampler	39.4	52.3	54.5	70.4
Middle Sampler	46.0	50.0	40.8	75.8
Bottom Sampler	52.5	72.5	37.0	66.0
Well #6	67.2	59.0	57.0	87.1
	46.5	---	---	---
Well #10	53.6	63.5	54.6	86.6
Well #13	36.4	65.5	42.5	91.5
Well #16	---	72.3	78.4	82.0

*Average percent MBAS reductions during the entire time period for which ABS and LAS was used as the washing compounds.

10. There was no additional degradation of the LAS-35 molecule in travel through the saturated soil zone.

11. Degradation in the unsaturated soil zone appeared to proceed at a relatively uniform rate, 1.5%/ft., between the top samplers and well No. 6. Initial travel in the unsaturated zone, cesspool to top samplers (18 inches), resulted in a degradation of 39.4 percent.

12. Large reductions in tritium and sulfur activities occurred during steady state conditions. Removal of total and undegraded sulfurs were achieved primarily prior to the top collectors, 18 inches below the cesspool bottom with little

additional reductions through the remaining portions of the flow path. Reductions in tritium activity occurred at all sampling locations. (Table 7-7)

Percent Reduction of Cesspool Steady-State Activities

	<u>Tritium</u>	<u>Total Sulfur</u>	<u>Undegraded Sulfur</u>
Cesspool	0	0	0
Top Sampler	5.45	83.8	91.5
Middle Sampler	2.93	88.0	94.5
Bottom Sampler	7.95	88.4	95.8
Well #6	14.70	86.0	95.8
Well #10	23.80	82.0	92.8
Well #13	38.50	90.3	94.6

13. Upon entering the saturated soil zone, a 25.7 and 44.5 percent increase in total and undegraded sulfur activities resulted between well groups No. 6 and No. 10. The increase in activity at Well No. 10 was undoubtedly due to the center of the waste slug bypassing Well No. 6.

14. Activity levels in the cesspool during the quasi-steady state conditions (9/30/65 - 11/8/65) indicated that approximately 50 percent of the calculated initial activity remained in the liquid phase of the cesspool. The remaining 50 percent calculated activity was assumed to become associated with the sludge in the cesspool and immediate soil region.

15. Degradation of 51-65 percent in the cesspool sludge resulted during a short testing interval at the end of the study. (Table 7-8)

16. Soil core samples collected on 12/28/65, after continuous dosing was discontinued, indicated between 19.7 and 58.1 percent degradation of the tagged LAS-35.

17. Dilutional effects as measured by changes in tritium activity indicated average rates of reduction, dilution, of about 0.73 percent per foot in the unsaturated zone (cesspool to first well group). Travel in the saturated ground water zone resulted in a rate of tritium reduction of approximately 1.43 percent per foot being about

TABLE 7-7

SUMMARY DATA
PHASE I - RADIOACTIVE TAG STUDY

% Reduction of Cesspool Activity
(Steady State)

	Tritium	Total Sulfur	Undegraded Sulfur
Cesspool	0	0	0
TGL	5.4	83.8	91.5
MGL	2.93	88.0	94.5
BGL	7.95	88.4	95.8
Well #6	15.0	86.0	96.0
	69.0	91.0	95.5
Well #10	23.8	82.0	92.8
Well #13	38.5	90.3	94.6
Well #16			

% Reduction of Cesspool MBAS Conc.

ABS	LAS	LAS (Phase II- only)
0	0	0
52.3	54.5	70.0
50.0	40.8	75.5
72.5	37.0	65.5
59.0	57.0	56.5
63.5	54.6	87.0
65.5	42.5	82.0
72.3	78.4	

% Reduction of Well #6 Activity

	H	T.S	U.S
Well #6	0	0	0
Well #10	14.7	+25.7	+44.5
Well #13	27.9	31.8	+30.7
Well #16			

% Reduction of Well #6 MBAS Conc.

ABS	LAS	LAS (Phase II)
0	0	0
11.0	+4.8	+54.0
15.8	+33.0	+45.2
32.3	50.0	

Average Rate of Reduction (Tritium)

Well #6-#10 (10') 1.47%/ft.

Well #10-#13 (10') 1.40%/ft.

Average rate = 1.435%/ft.

Average rate = 0.86%/day

Average Rate of Reduction (Chlorides)

ABS (Well #6-#16) 0.35%/ft. 0.21%/day

LAS (Well #6-#16) 0.67%/ft. 0.40%/day

TABLE 7-8
SUMMARY DATA
PHASE II - RADIOACTIVE TAG STUDY

Soil Core Samples

Soil core samples collected on 9/6/65 and 11/9/65 gave results which were not valid.

Date and Location	Total Sulfur uc/100g × 10 ⁻⁵	Undegraded Sulfur uc/100g × 10 ⁻⁵	Percent Degradability
12/28/65 K	678.0	284.0	58.1
L	163.0	71.0	56.5
	122.0 (P&G)	98.0 (P&G)	19.7
M	46.1	28.4	38.3
N	17.6	13.5	23.3
	15.5 (P&G)	12.2 (P&G)	21.3

Sludge Samples

Date	Total Sulfur uc/g × 10 ⁻⁴	Undegraded Sulfur uc/g × 10 ⁻⁴	Percent Degradability
9/29/65			
10/4			
10/10	Not Valid Results		
10/18	(9/29/65 - 11/1/65)		
11/1			
11/5	284	111	61.0
11/15	136	63	53.5
11/19	120	48.9	59.2
11/24	248	109	56.0
11/26	171	83.5	51.5
11/29	123	43.2	64.8

twice as great as the reduction rate during movement through the unsaturated soil zone. Rates of reduction based upon tritium activity varied from rates observed by using chloride concentrations.

Rates of Reduction (Dilution)

	<u>Unsaturated Sands</u>	<u>Saturated Sands</u>
Tritium (LAS usage)	0.73%/ft.	1.43%/ft.
Chlorides (ABS usage)	0.90	0.35
Chlorides (LAS usage)	1.17	0.67

18. Generally, the only factor causing reductions in tritium activity and chloride concentrations is that of dilution. Dilution factors based upon tritium compared quite favorably with those based upon average chloride values. (Table III-1, 6)

Dilution Factors

Cesspool Concentration
Sampling Point Concentration

	Chlorides		
	<u>Tritium</u>	<u>ABS</u>	<u>LAS</u>
Cesspool	----	----	----
Top Sampler	1.06	0.97	0.96
Middle Sampler	1.04	1.08	1.01
Bottom Sampler	1.09	1.15	1.06
Well #6	1.18	1.21	1.30
Well #10	1.38	1.19	1.26
Well #13	1.62	1.28	1.35
Well #16	----	1.40	1.78

19. There was adsorption - desorption of tagged LAS materials on the sludge and soils as demonstrated by the results of samples collected June 17, 1966 about 7 months after completion of the Phase II study. Activity levels indicated that there was still a small release of radioactive materials from the cesspool-soil areas.

Total Sulfur Activities

	<u>Dec. 8, 1965</u>	<u>June 17, 1966</u>
Cesspool	4.74×10^{-5} mc/ml	3.50×10^{-6} mc/ml
Top Samplers	3.67×10^{-5} " (11/17)	3.34×10^{-6} "
Middle Samplers	2.00×10^{-5} "	2.66×10^{-6} "
Bottom Samplers	2.62×10^{-5} " (12/3)	
Well #6	2.66×10^{-5} "	
Well #10-#11	4.11×10^{-5} "	3.48×10^{-6} "
Well #13-#14	1.95×10^{-5} "	1.75×10^{-6} "
	(H - 0.672×10^{-3})	(H - 1.54×10^{-5})
Well #17		1.50×10^{-6}

Dissolved Oxygen

1. Dissolved oxygen data was not obtained on this site.

pH

1. Little variation was observed in pH levels in the disposal system and through the upgradient and downstream sampling locations (pH 5.2-6.7).

Ammonia

1. Free ammonia concentrations in the disposal system was relatively constant during the use of ABS and LAS surfactants being 90.3 and 83.5 mg/l, respectively. (Table 7-1) All background observation wells indicated an average free ammonia level of 0.20 mg/l.
2. Movement of the sewage slug through the unsaturated zone, cesspool to first well group, resulted in the net reductions in free ammonia of 59.0 and 68.5 percent during the use of ABS and LAS. (Table 7-1; Figure 3-31 through 34)
3. In the unsaturated soil zone on Site No. 3 during ABS usage, free ammonia levels increased 60.5 percent (90 mg/l to 145.0 mg/l) in travel between the cesspool and top samplers (vertical travel distance of 18 inches). This increase in free ammonia was undoubtedly the result of the filtering out of organic nitrogen at the cesspool-soil

interface and its subsequent conversion (oxidation) to free ammonia. (figure 7-15 Table 7-1)

4. Through the remainder of the unsaturated zone, free ammonia levels reduced significantly (77.3 percent) (145 mg/l to 33 mg/l) between the top and middle samplers (vertical distance of 4 feet), then remained relatively unchanged to the first downstream well group. (Figure 7-15 Table 7-3)

Cesspool	90.3 mg/l
Top Samplers	145.0
Middle Samplers	33.1
Bottom Samplers	27.3
Well #6	27.9

5. Travel of the sewage slug through the downstream saturated soil zone, first to last well groups, resulted in a 29.6 and 53.2 percent reduction in ammonia during the use of ABS and LAS. (Figure 7-15 through 19; 7-31 through 34) Average rates of ammonia reduction in this saturated zone were:

	<u>Average Values</u>			<u>Least Squares</u>		
ABS	0.73%/ft.	0.44%/day	0.20 mg/l/ft.	0.75%/ft.	0.45%/day	0.22 mg/l/ft.
LAS	1.33	0.80	0.35	0.047	0.028	0.025

Compensating for dilution based upon reductions in chloride concentrations still resulted in net rates in ammonia reduction of:

	<u>Average Values</u>	
ABS	0.38%/ft.	0.23%/day
LAS	0.66	0.40

6. Since there was no corresponding increase in other nitrogen compounds, the free ammonia reduction through this portion of the flow path was due to factors other than dilution and/or biological activity and can be attributed primarily to adsorption.

Nitrites

1. Nitrite levels in the disposal system were constant during the use of (P. 7-50)

LONG ISLAND GROUND WATER POLLUTION STUDY
 REDUCTION VERSUS TRAVEL TIME
 AMMONIA (9/16/1963-1/24/1966)
 SITE Nº 3 - BOHEMIA, SUFFOLK COUNTY, N. Y.

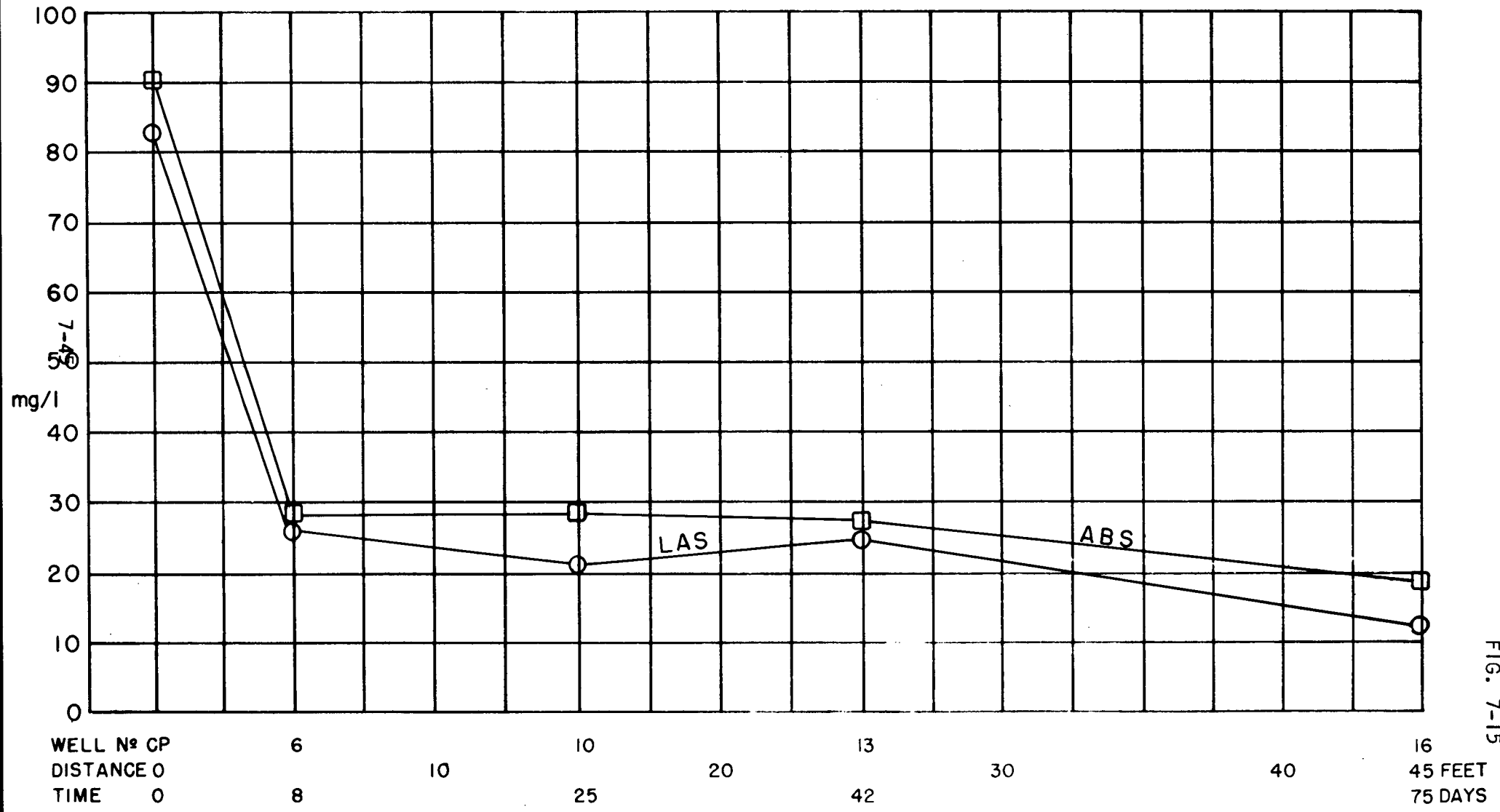

FIG. 7-15

LONG ISLAND GROUND WATER POLLUTION STUDY
 PERCENT REMAINING OF FIRST WELL CONCENTRATION
 AMMONIA (9/16/1963-1/24/1966)
 SITE N^o 3 - BOHEMIA, SUFFOLK COUNTY, N. Y.

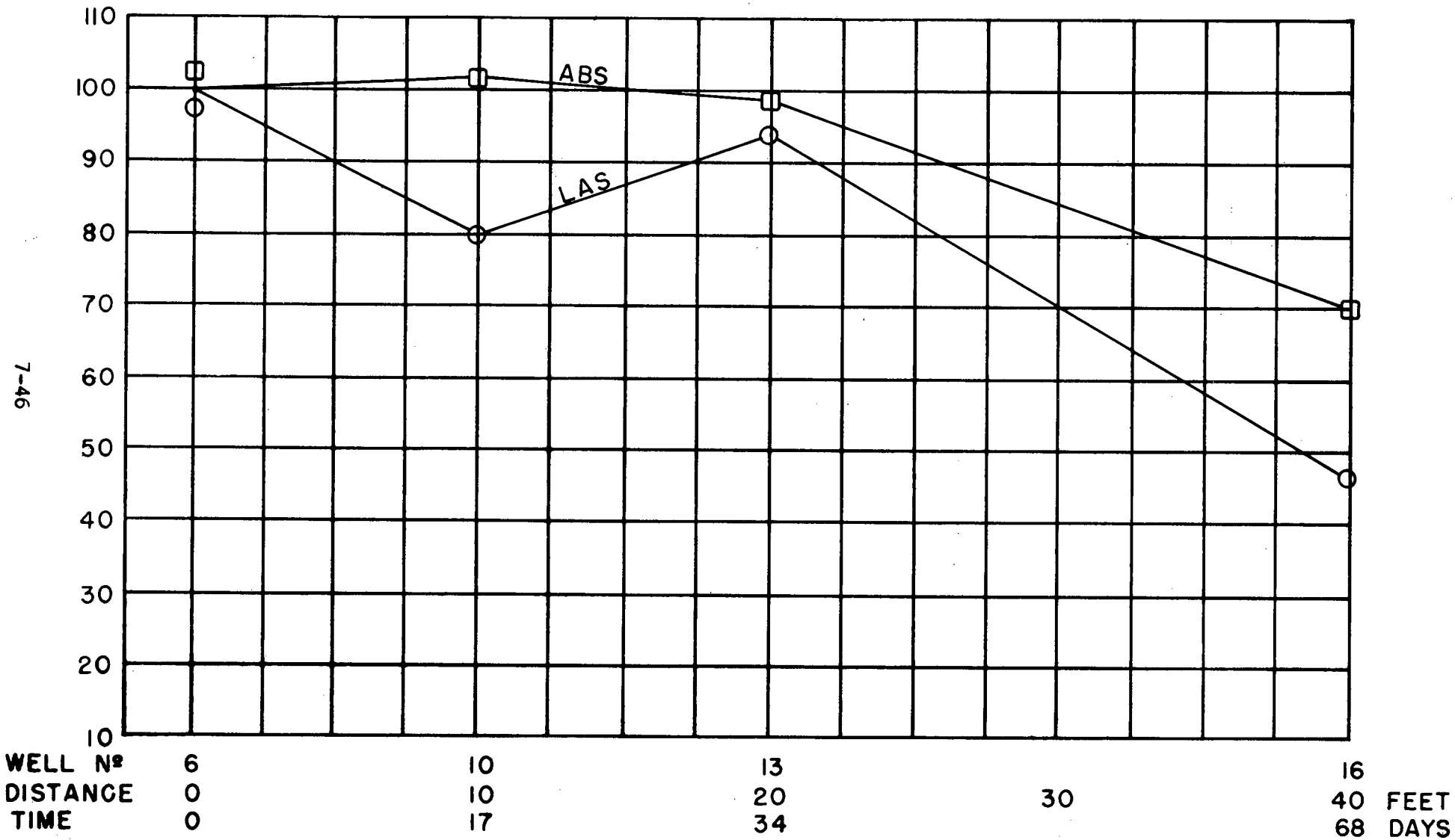
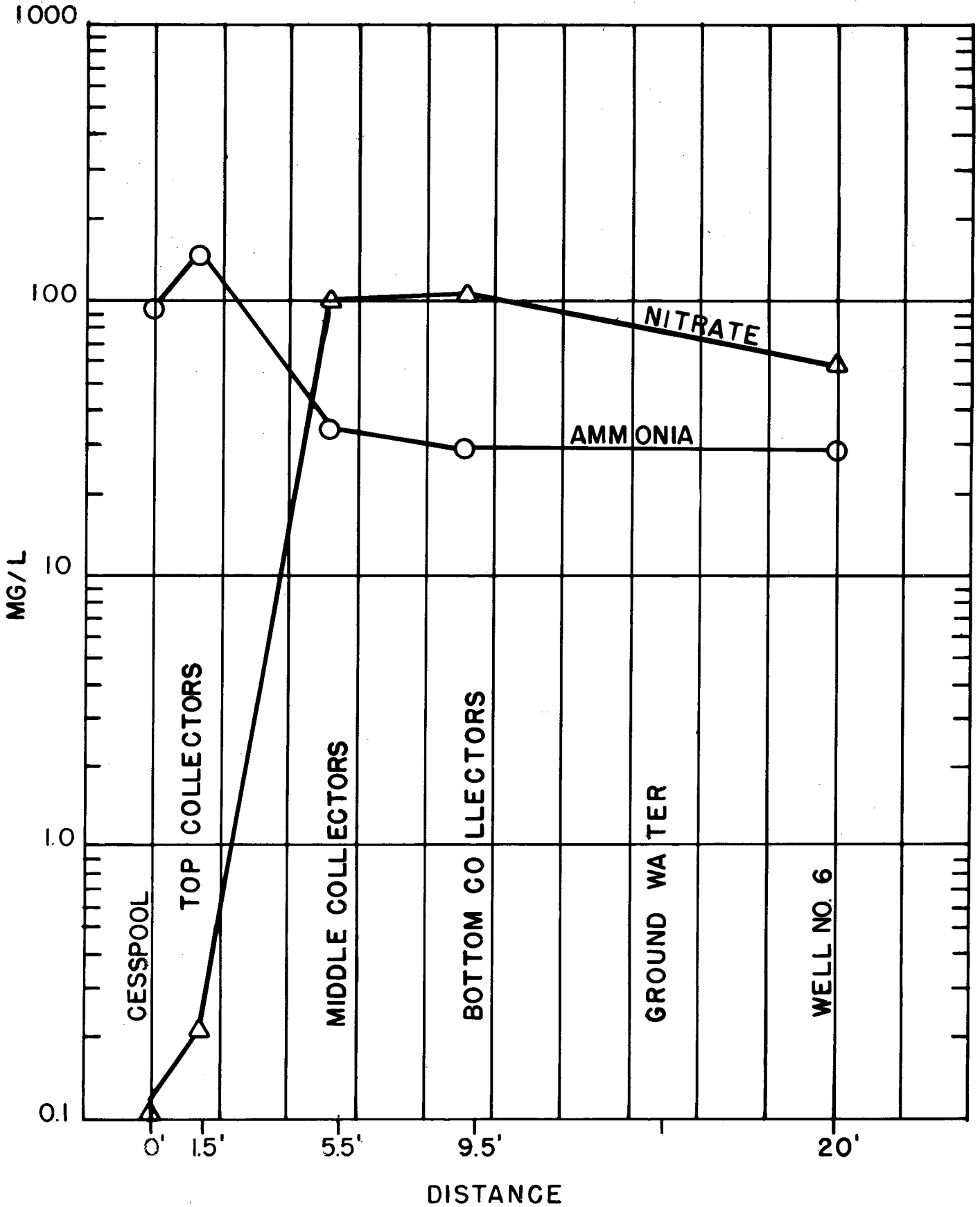
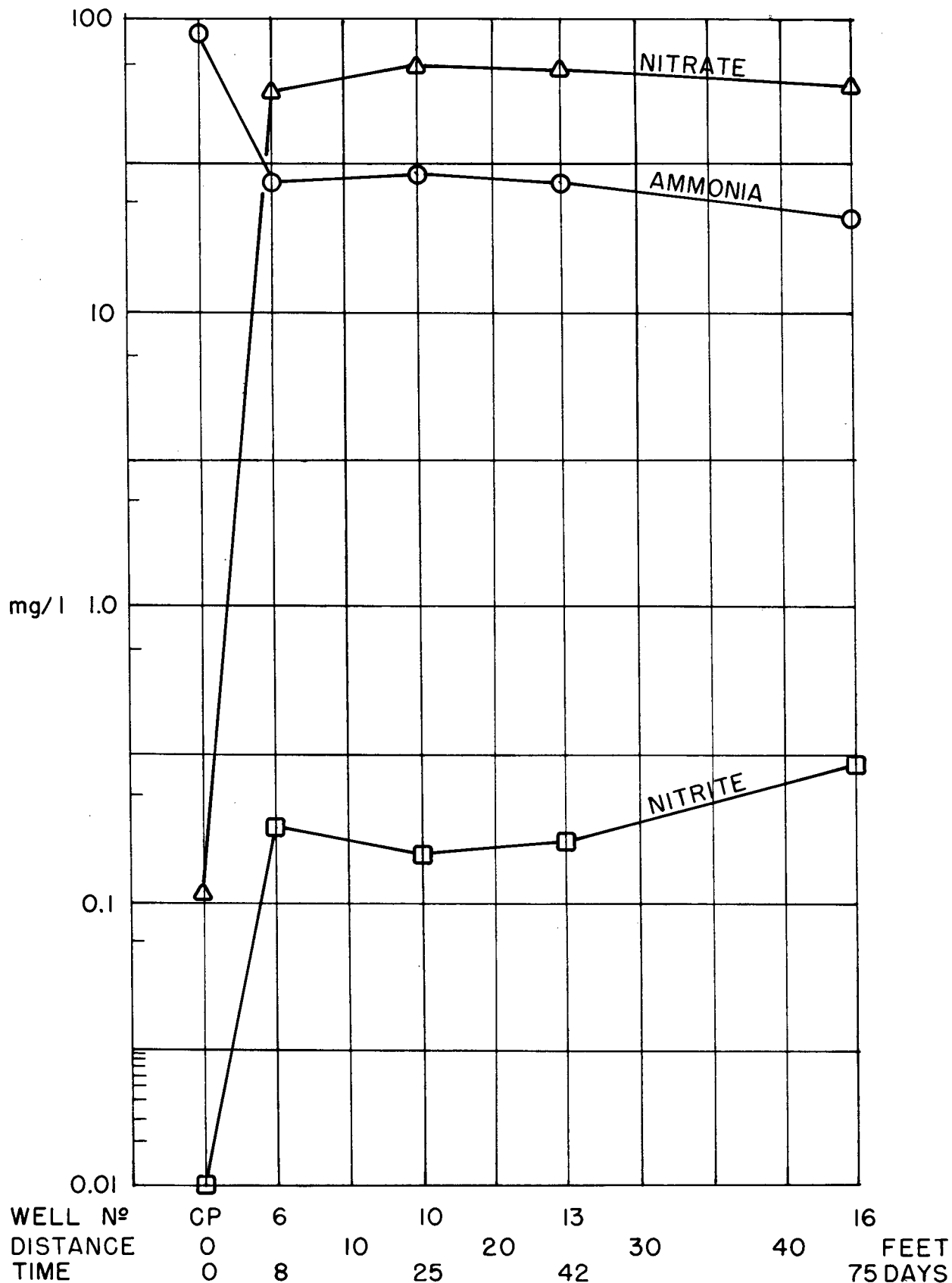

FIG. 7-16

LONG ISLAND GROUND WATER POLLUTION STUDY
NITROGEN CYCLE VERSUS TRAVEL TIME
ABS IN USE (9-16-'63 / 1-4-'65)
SITE 3. BOHEMIA, SUFFOLK COUNTY



LONG ISLAND GROUND WATER POLLUTION STUDY
 NITROGEN CYCLE VERSUS TRAVEL TIME
 ABS IN USE (9/16/1963 - 1/4/1965)
 SITE N° 3 - BOHEMIA, SUFFOLK COUNTY, N. Y.



LONG ISLAND GROUND WATER POLLUTION STUDY
 NITROGEN CYCLE VERSUS TRAVEL TIME
 LAS IN USE (1/4/1965 - 1/24/1966)
 SITE N° 3 - BOHEMIA, SUFFOLK COUNTY, N. Y.

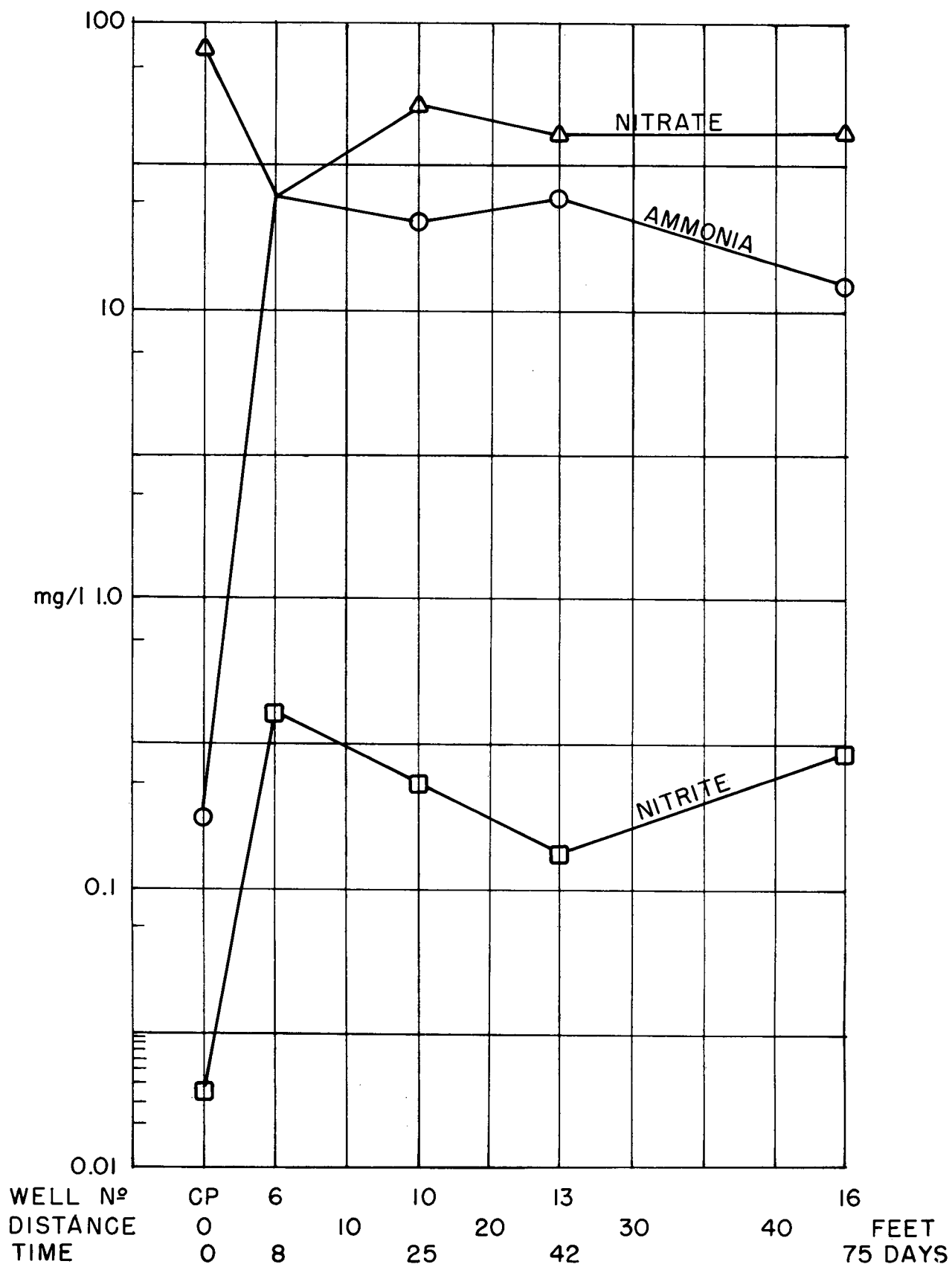

ABS and LAS being 0.02 mg/l. (Table 7-1) All background wells indicated a uniform nitrite concentration of 0.03 mg/l.

2. On Site No. 3 it is assumed that maximum nitrite levels occurred within the unsaturated soil zone. This conclusion is based upon the observation of peak nitrate levels at the bottom samplers and the fact that nitrite development in the nitrogen oxidation process precedes the production of nitrates. (Figure 7-17)

3. Travel through the downstream saturated zone resulted in relatively constant nitrite levels at all sampling locations. (Figure 7-18, 19)

Nitrates

1. In the cesspool nitrate concentrations are relatively constant during the use of ABS and LAS being 0.10 and 0.19 mg/l, respectively. (Table 7-1)

Upstream observation wells indicated a uniform nitrate content of 1.40 mg/l throughout the sampling depth. (Table 4-1)

2. Travel of the slug through the unsaturated soils resulted in increasing nitrate levels obtaining maximum concentrations at the bottom samplers during the use of ABS. (Figure 7-17 Table 7-2)

Cesspool	0.10 mg/l nitrate
Top Samplers	0.21
Middle Samplers	97.5
Bottom Samplers	105.8
Well #6	58.0

3. At the first well group in the saturated zone, nitrate concentrations reduced to 58.0 and 35.7 mg/l during the use of ABS and LAS. There appeared to be a secondary increase in nitrate levels resulting in a second peak 64.5 ABS, 52.2 LAS occurring at well group No. 10, 15 feet downstream from the disposal system. (Table 7-1 Figure 7-18, 19) This secondary increase in nitrates may be partially due to shortcircuiting between the bottom samplers and well No. 6.

4. Reductions in nitrate levels beyond well group No. 10 proceeded at a relatively constant rate during the use of both surfactants as shown below:

Average Values

ABS	0.57%/ft.	0.34%/day	0.37 mg/l/ft.
LAS	0.58	0.35	0.32

Compensating for dilution based upon chloride reductions resulted in net rates of nitrate reduction through the saturated soil zone of:

Average Values

ABS	0.22%/ft.	0.13%/day	
LAS	Dilution values exceeded actual reduction rates.		
	Reduction rates in excess of dilutional effects represent decreases due to biological, physical or chemical processes.		

Sulfates

1. Sulfate concentrations in the disposal system varied, depending upon the surfactant in use averaging 34.2 and 10.8 mg/l during ABS and LAS usage, respectively. (Table III-1) Uniform sulfate concentrations were observed in all background wells and averaged 10.0 mg/l. (Table 4-1)
2. Net increases in sulfate levels, 6.4 and 100 percent during ABS and LAS usage, occurred during travel of the waste through the unsaturated sands (cesspool and first well group). (Table 7-1) Variations in sulfate levels at various stages of travel in the unsaturated zone were not determined.
3. Movement of the sewage slug in the saturated downstream zone (first to last well groups) resulted in an overall 11.3 percent increase during use of ABS and 38.6 percent decrease in sulfate concentration during the use of LAS. (Figure 7-20) The rate of decrease is given below:

Average Values

ABS	Slight increase in levels		
LAS	0.97%/ft/	0.58%/day	0.21 mg/l/ft.

LONG ISLAND GROUND WATER POLLUTION STUDY
 REDUCTION VERSUS TRAVEL TIME
 SULFATES (9/16/1963-1/24/1966)
 SITE N^o 3 - BOHEMIA, SUFFOLK COUNTY, N. Y.

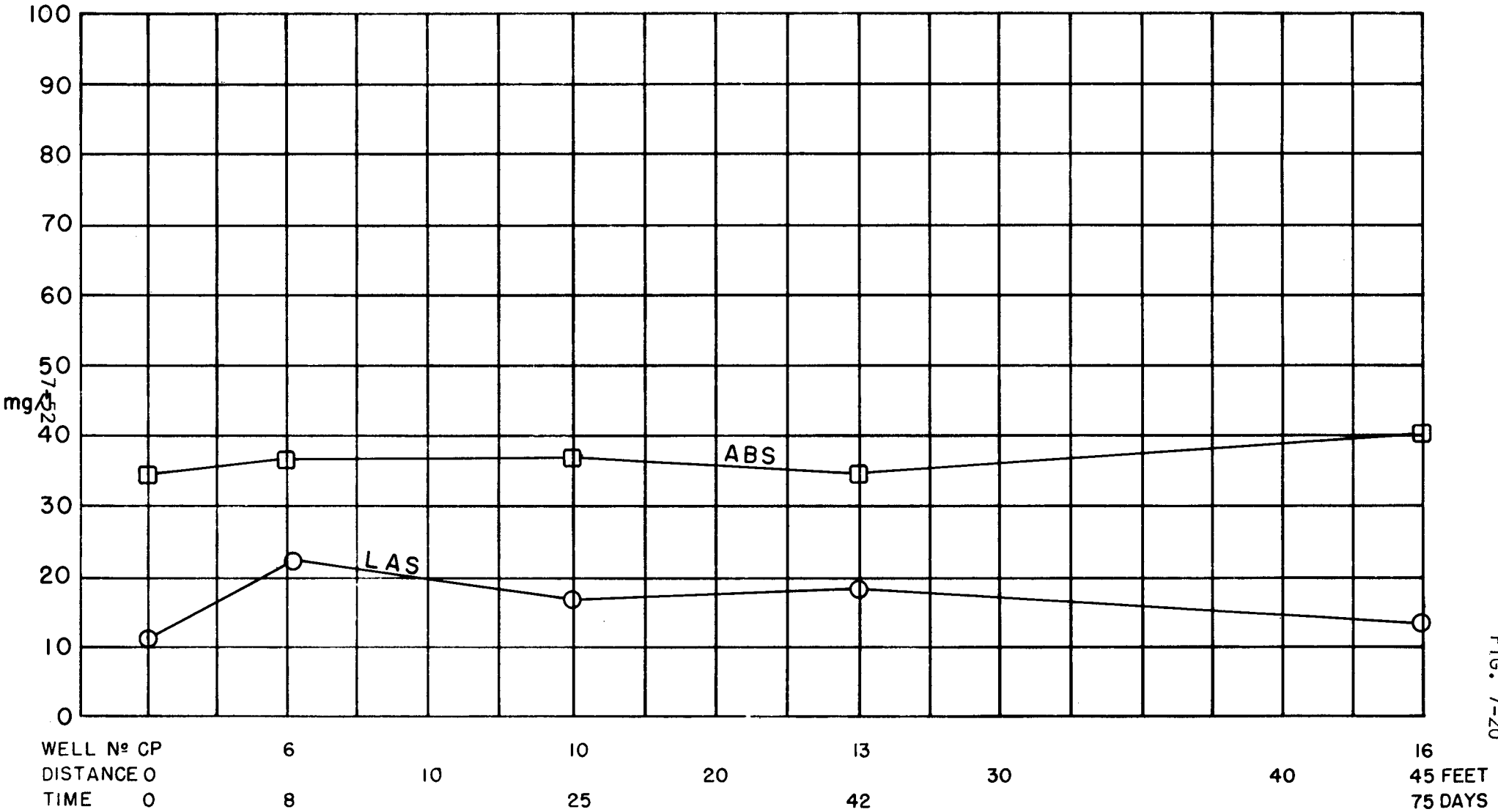

FIG. 7-20

Adjusting for dilutional effects based upon chloride reductions resulted in a net rate of sulfate reduction during LAS usage of:

Average Values

LAS	0.30%/ft.	0.18%/day
-----	-----------	-----------

Phosphates

1. In most instances the ortho and total phosphate concentrations in the disposal system and downstream wells were approximately equal. Total phosphates in the disposal system average 88.3 and 66.5 mg/l during the use of ABS and LAS surfactants, respectively. (Table 7-1) All background wells indicated an average total phosphate concentration of 0.06 mg/l. (Table 4-1)
2. Between the cesspool and first well group, unsaturated soil zone, a 44.0 percent (88.3 - 49.5 mg/l) and 76.0 percent (66.5 - 15.6 mg/l) reduction in total phosphate concentration resulted during the use of ABS and LAS surfactants, respectively. (Table 7-1, 3)
3. Travel in the first 18 inches of the unsaturated soil zone, cesspool to top sampler, resulted in a 34.5 percent (88.3 - 57.7 mg/l) and 52.2 percent (66.5 - 31.8 mg/l) reduction in total phosphate concentrations during the use of ABS and LAS surfactants. (Table 7-1, 2, 3)
4. Movement of the sewage slug through the remainder of the unsaturated zone resulted in varying phosphate concentrations at the various sampling points. (Table 7-2) At the first downstream well group No. 6, total phosphate levels were reduced to 49.5 and 15.6 mg/l during the use of ABS and LAS.
5. Based upon the difference in total phosphate concentrations between the top samplers and first downstream well group, overall average phosphate rates of reduction through the unsaturated soil zone were:

Average Values

ABS	0.77%/ft.	0.44 mg/l/ft.
LAS	2.75	0.88

6. Increases in total phosphate concentrations occurred during movement of the waste slug through the initial saturated zone flow path, Wells No. 6 to No. 10. (10 feet travel distance). Fig. 7-21, 22; 7-31 thru 34) Further travel in the saturated zone, Well No. 10 to final well group, resulted in phosphate reduction rates of:

		<u>Average Values</u>		
ABS	Well #10 to #16	1.78%/ft.	1.07%/day	0.96 mg/l/ft.
LAS	Well #10 to #16	3.10	1.86	0.69

Compensating for dilution, based upon reductions in chloride concentrations, resulted in net phosphate removal rates (Wells #10 to #16) of:

		<u>Average Values</u>	
ABS		1.43%/ft.	0.86%/day
LAS		2.43	1.46

7. Net phosphate reductions indicated that factors other than dilution cause reductions through the downstream flow path. Utilization of ortho phosphates as part of the biological metabolic process, physical and/or chemical processes, are possible factors contributing to the overall phosphate reduction.

8. Total reductions in phosphate concentrations, cesspool to final well group, were only 72.2 percent during the use of ABS as compared to 98.0 percent with LAS usage. (Figure 7-21, 22)

Coliform Organisms

1. Log average coliform populations (MPN's) in the cesspool were 8.59×10^6 and 16.5×10^6 per 100 ml during the use of ABS and LAS surfactants, respectively. (Table 7-1)

2. Travel of the waste slug through about 20 feet of unsaturated sands, cesspool to first well group No. 6, resulted in coliform reductions of 99.9 percent during the use of both surfactants. (Table 7-1, 3 Figure 7-23, 24; 7-31 through 34)

3. Coliform reductions through the unsaturated soil zone were not determined. It was, therefore, unknown if removal of the coliform organisms occurred by filtering

LONG ISLAND GROUND WATER POLLUTION STUDY
 REDUCTION VERSUS TRAVEL TIME
 TOTAL PHOSPHATES (9/16/1963 - 1/24/1966)
 SITE N° 3 - BOHEMIA, SUFFOLK COUNTY, N. Y.

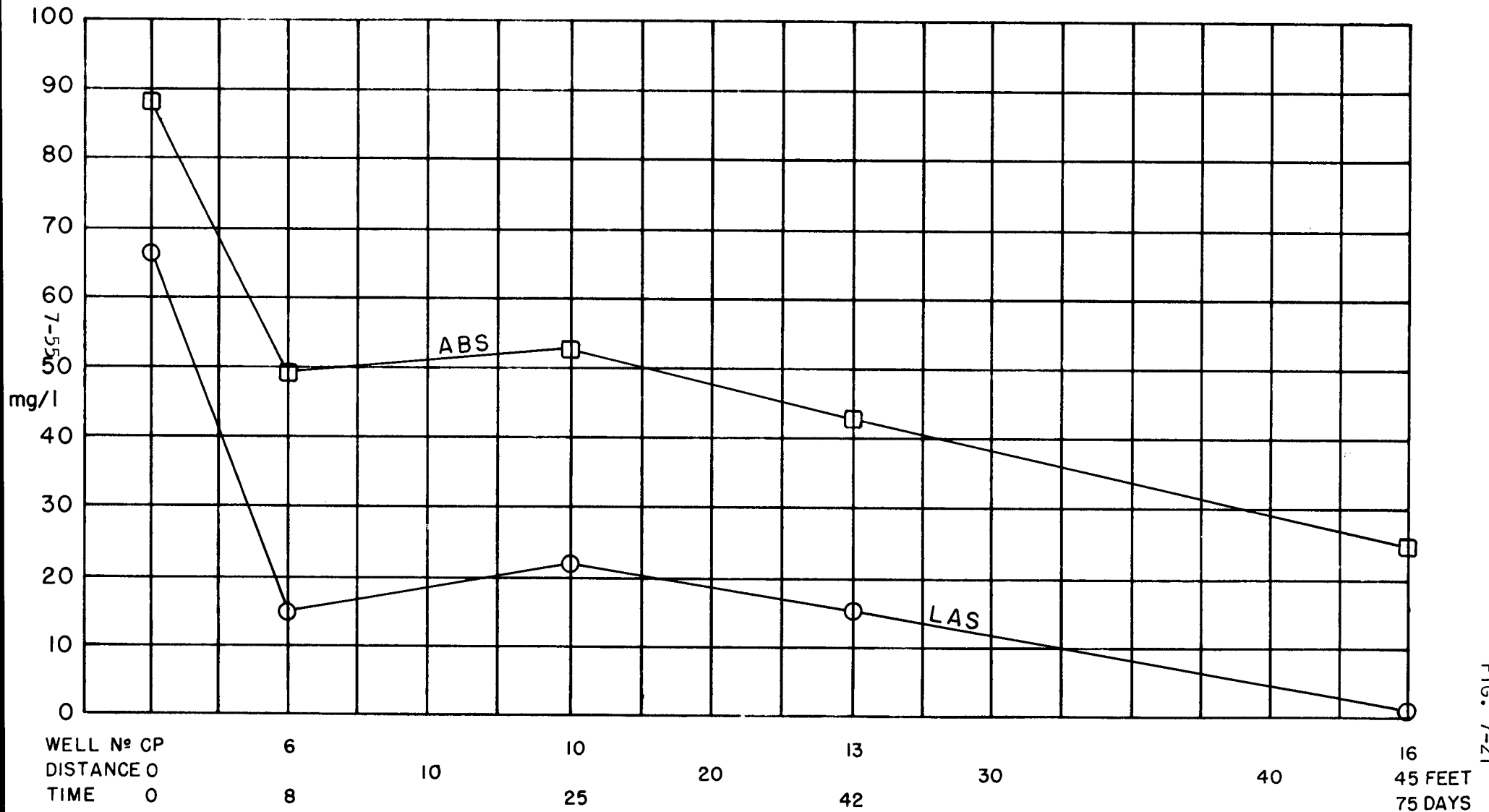

FIG. 7-21

LONG ISLAND GROUND WATER POLLUTION STUDY
 PERCENT REMAINING OF FIRST WELL CONCENTRATION
 TOTAL PHOSPHATES (9/16/1966-1/24/1966)
 SITE N° 3 - BOHEMIA, SUFFOLK COUNTY, N. Y.

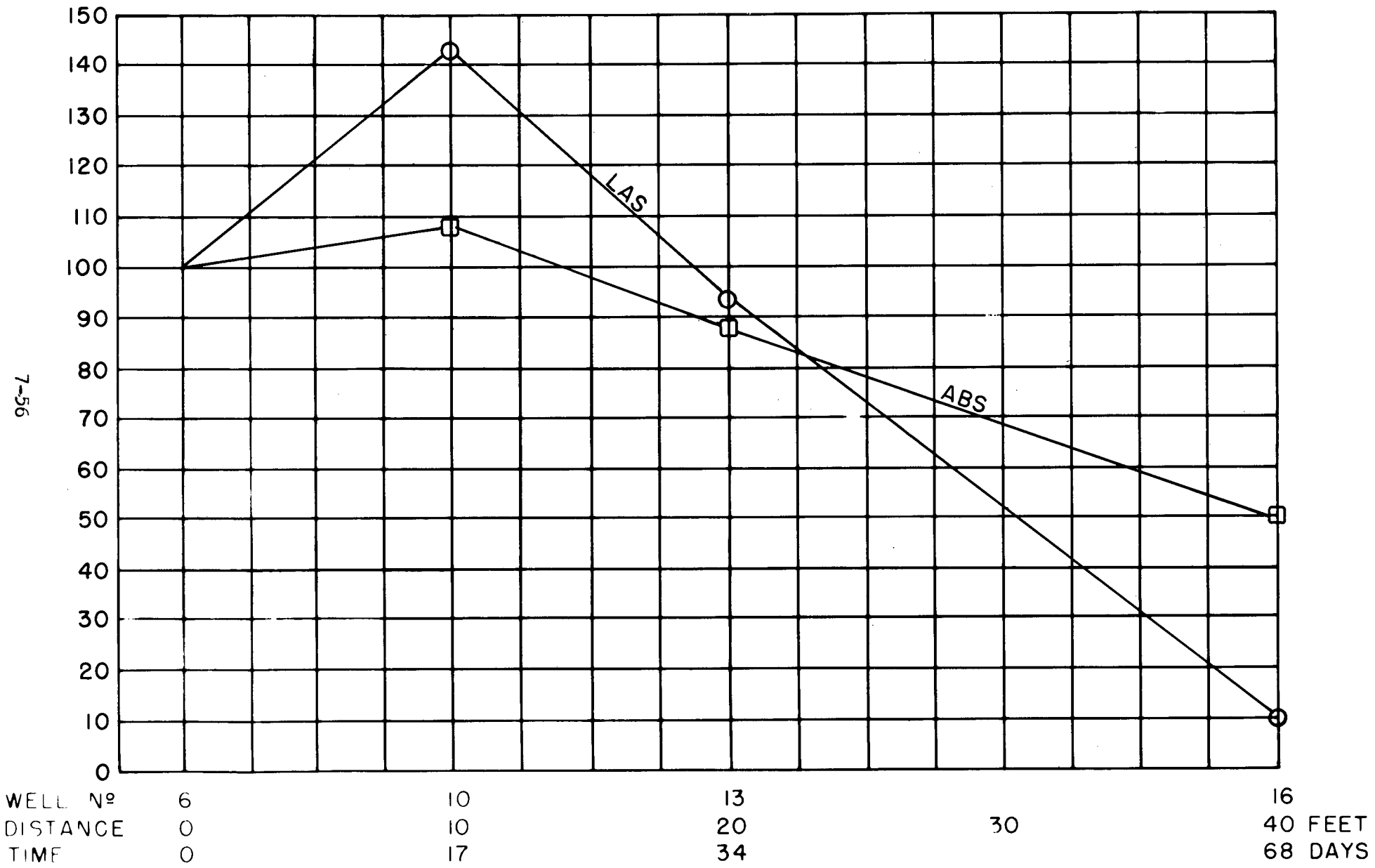
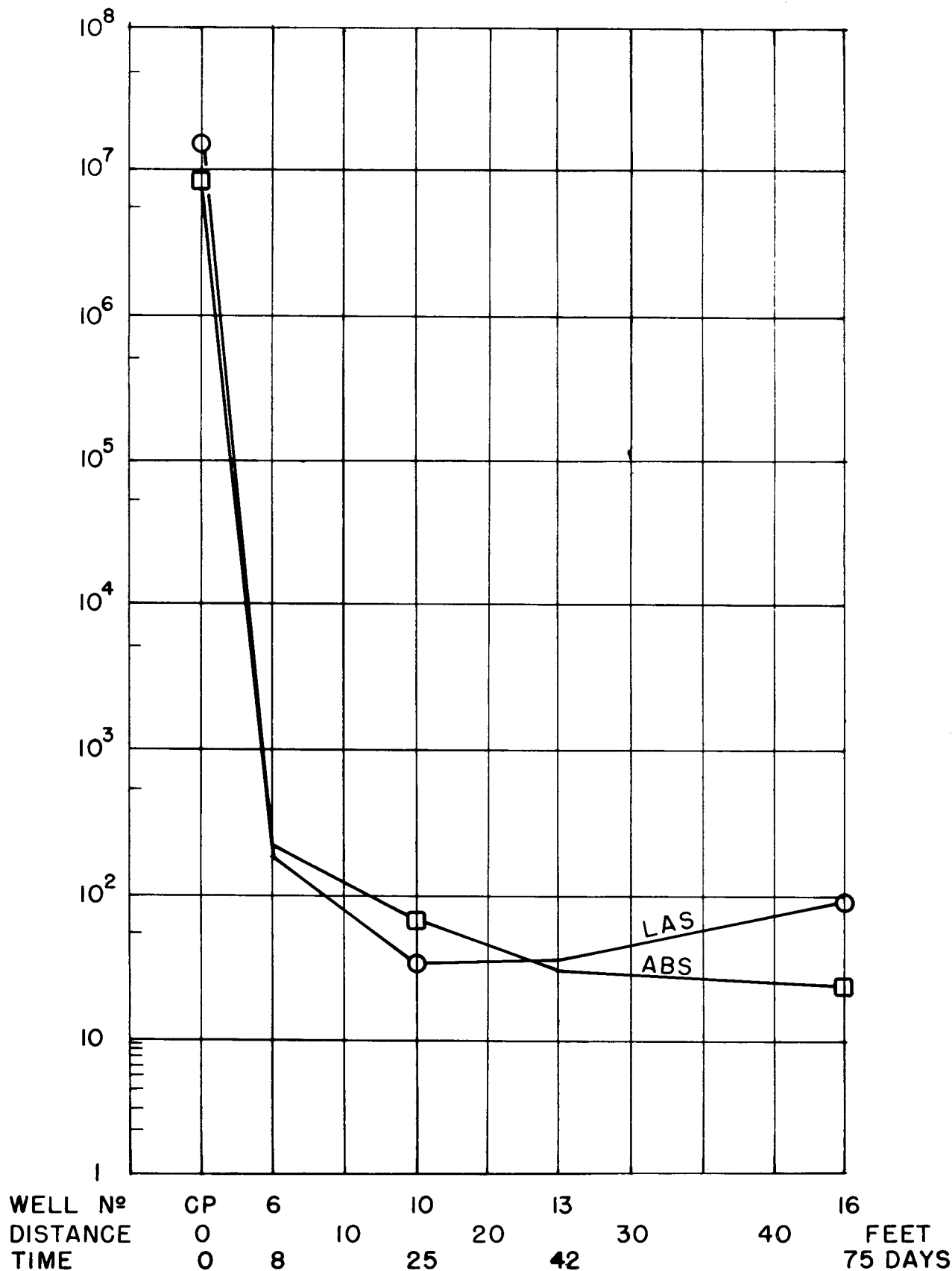

FIG. 7-22

LONG ISLAND GROUND WATER POLLUTION STUDY
 REDUCTION VERSUS TRAVEL TIME
 LOG AVERAGE COLIFORM (9/16/1963 - 1/24/1966)
 SITE N° 3 - BOHEMIA, SUFFOLK COUNTY, N. Y.



LONG ISLAND GROUND WATER POLLUTION STUDY
 PERCENT REMAINING OF FIRST WELL CONCENTRATION
 LOG AVERAGE COLIFORM (9/16/1963-1/24/1966)
 SITE N° 3 - BOHEMIA, SUFFOLK COUNTY, N. Y.

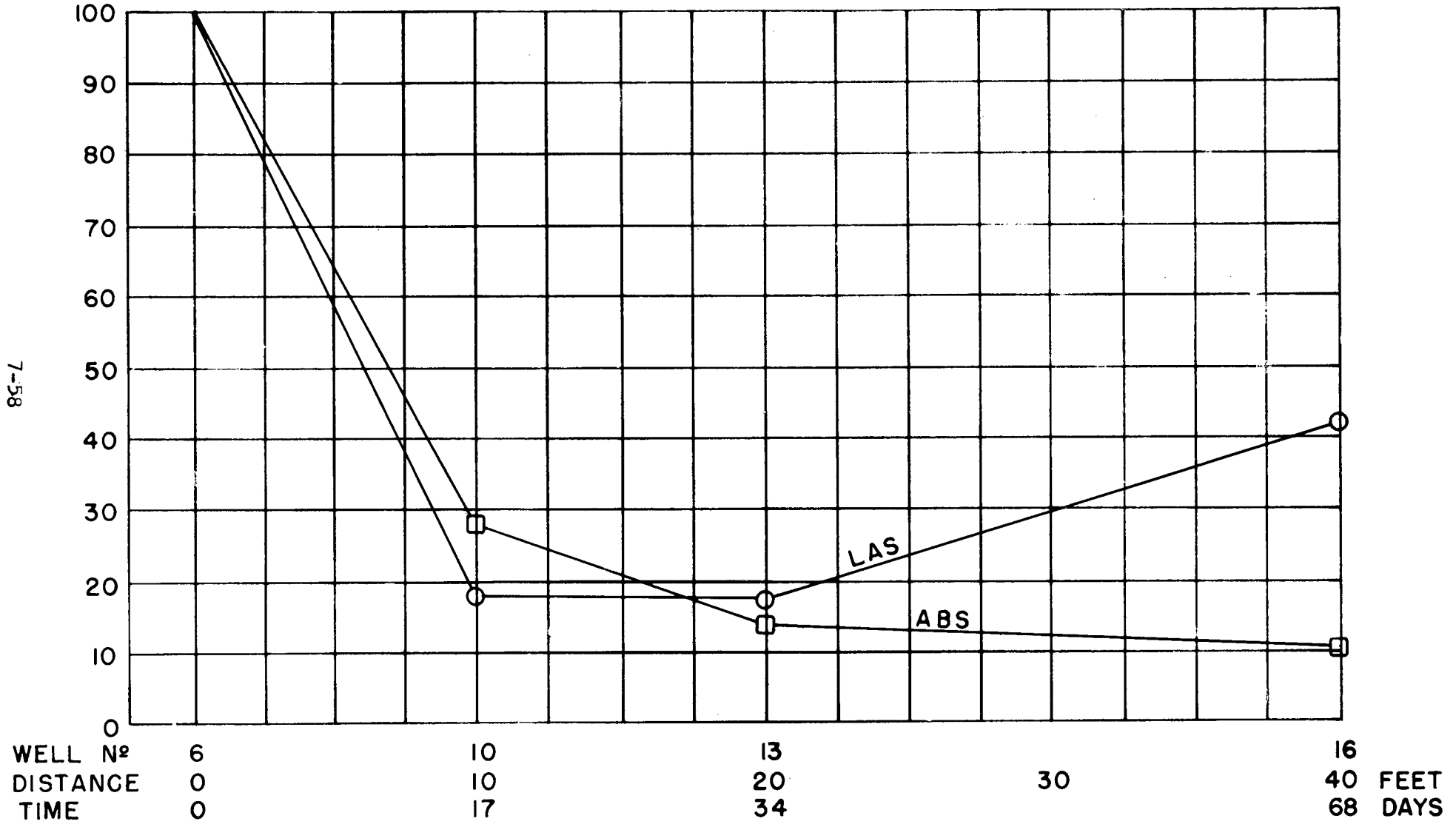

FIG. 7-24

out at the cesspool-unsaturated soil interface or throughout the entire vertical travel distance.

4. Despite substantial reduction rates log average coliform densities of 239 and 202 per 100 ml persisted at the first downstream Well No. 6. (Table 7-1)

5. Movement of the sewage slug through the downstream saturated soil zone resulted in lower coliform reductions, 89.5 and 58.0 percent of the first well group densities as compared to travel in the unsaturated sands. (Figure 7-23, 24)

6. Although the overall reductions in coliform densities (cesspool to final well group) exceeded 99.0 percent, remaining densities exceeded the limits set forth for potable water. At the final well group, 45 feet downstream from the cesspool, log average coliform densities of 25 and 85 percent still existed.

Alkalinity

1. Alkalinity concentrations in the disposal system were relatively constant during the use of ABS and LAS surfactants, averaging 423 and 450 mg/l as CaCO_3 , respectively. (Table 7-1) Upstream observation wells exhibited uniform alkalinity levels averaging 25.0 mg/l as CaCO_3 . (Table 4-1)

2. Substantial reductions in alkalinity resulted in travel of the sewage slug through the unsaturated soil zone during the use of ABS and LAS surfactants. Data was not obtained to establish alkalinity reduction characteristics in vertical travel through the unsaturated zone. (Table 7-1, 3)

3. Movement through the downstream flow path (first to last well groups) resulted in relatively little additional alkalinity in comparison to reductions observed in the unsaturated zone. (Figure 7-25, 26; 7-31 through 34) Average alkalinity reduction rates in the saturated zone were:

	<u>Average Values</u>		
ABS	0.51%/ft.	0.30%/day	0.152 mg/l/ft.
LAS	1.08	0.65	1.35

Adjusting for dilutional effects based upon reductions in chloride concentrations

LONG ISLAND GROUND WATER POLLUTION STUDY
 REDUCTION VERSUS TRAVEL TIME
 ALKALINITY (9/16/1963 - 1/24/1966)
 SITE N° 3 - BOHEMIA, SUFFOLK COUNTY, N. Y.

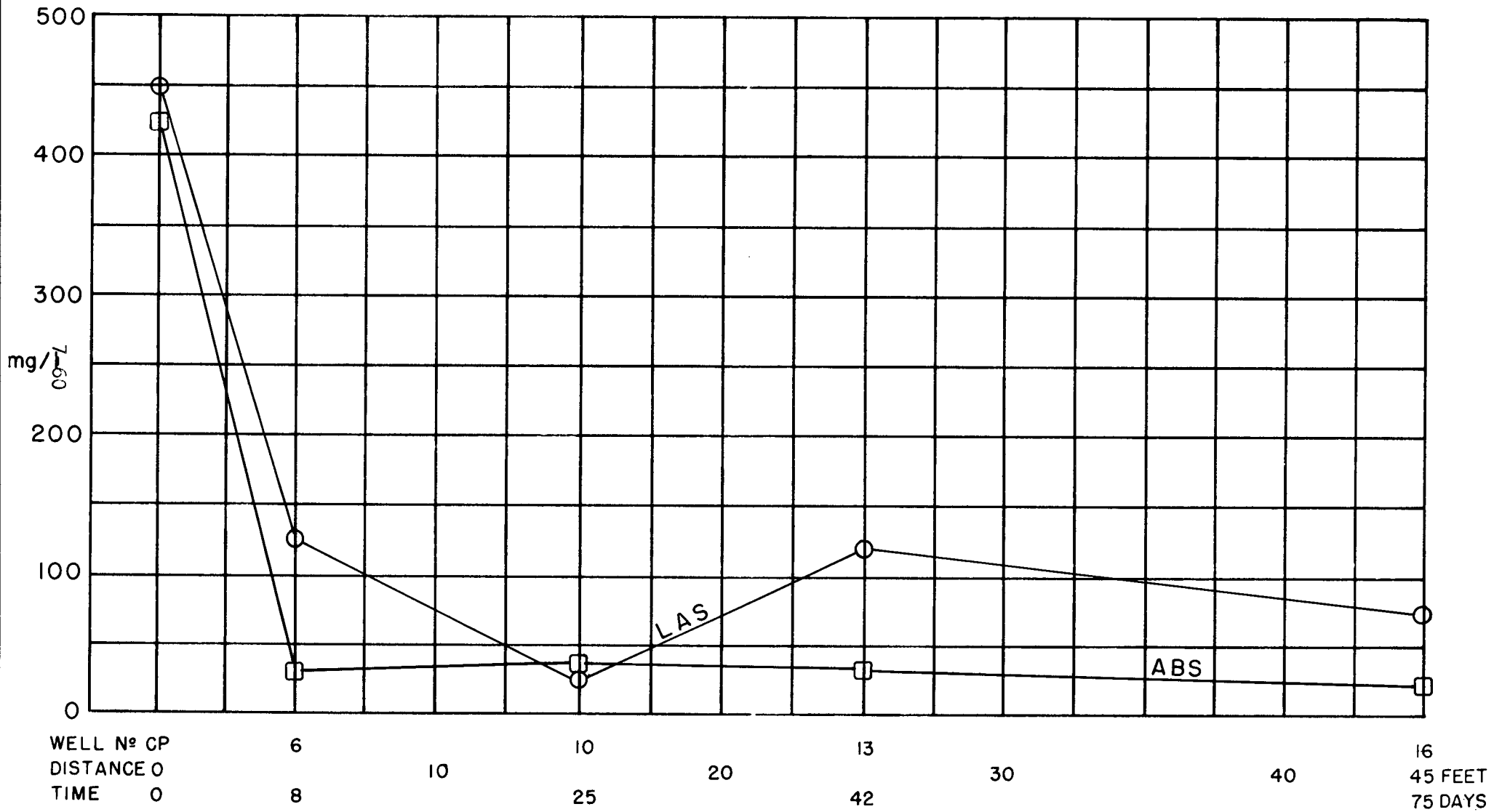

FIG. 7-25

LONG ISLAND GROUND WATER POLLUTION STUDY
 PERCENT REMAINING OF FIRST WELL CONCENTRATION
 ALKALINITY (9/16/1963 - 1/24/1966)
 SITE N° 3 - BOHEMIA, SUFFOLK COUNTY, N. Y.

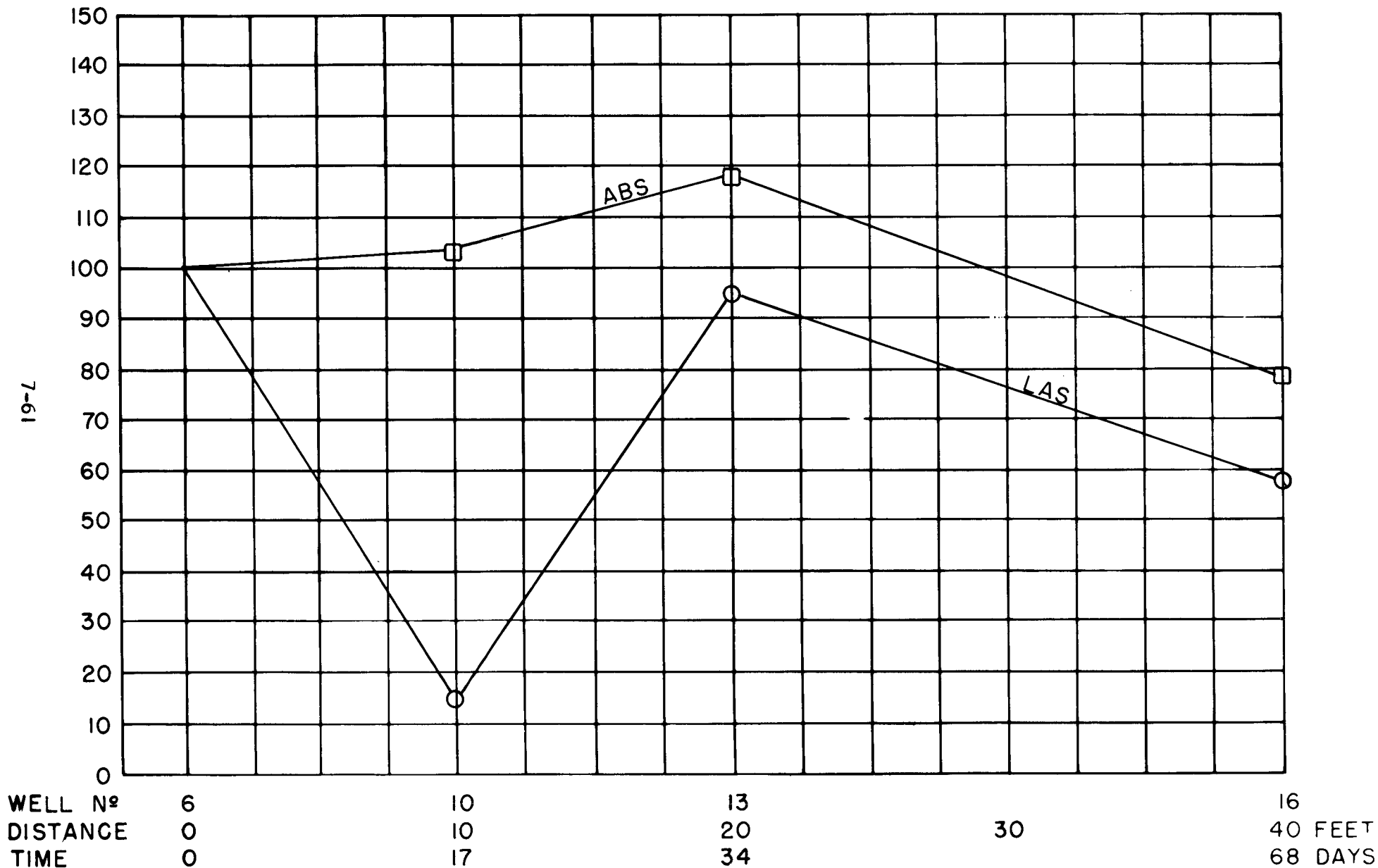

FIG. 7-26

resulted in average net alkalinity reduction rates of:

Average Values

ABS	0.16%/ft.	0.09%/day
LAS	0.41	0.25

4. It was concluded, based upon net alkalinity reduction rates, that factors other than dilution resulted in reducing alkalinity concentrations in travel through the saturated soil zone.

Specific Conductance

1. Specific conductivity in the cesspool was relatively constant during the use of ABS and LAS surfactants, averaging 850 and 815 umhos/cm², respectively. (Table 7-1) Background wells measured a uniform specific conductance of 60.0 umhos/cm². (Table 4-3)

2. Travel through approximately 20 feet of unsaturated sands, cesspool to first well group, resulted in a 33.6 and 27.6 percent reduction in specific conductance during the use of ABS and LAS surfactants, respectively. (Table 7-1, 3) Data was not obtained to establish reduction characteristics in the various sampling levels in the unsaturated zone.

3. In the saturated soil zone, a slight increase in conductivity resulted in travel of the waste slug between the first well group No. 6 and No. 10 (a distance of 10 feet) in the saturated zone. (Figure 7-27, 28) Beyond well group No. 10 specific conductivity decreased at a relatively uniform rate through the remaining portion of the flow path. Conductivity during the use of LAS reduced in the saturated soil zone at a generally decreasing rate. (Figure 7-31 through 34)

4. Average rates of reduction through the saturated zone of specific conductivity was:

Average Values

ABS	Well #10 to #16	0.42%/ft.	0.25%/day	2.56 umhos/cm ² /ft.
LAS	Well #6 to #13	1.66	1.0	9.80

Compensating for dilutional effects based upon chloride reduction resulted in net

LONG ISLAND GROUND WATER POLLUTION STUDY
 REDUCTION VERSUS TRAVEL TIME
 SPECIFIC CONDUCTANCE (9/16/1966-4/26/1965)
 SITE N^o 3 - BOHEMIA, SUFFOLK COUNTY, N. Y.

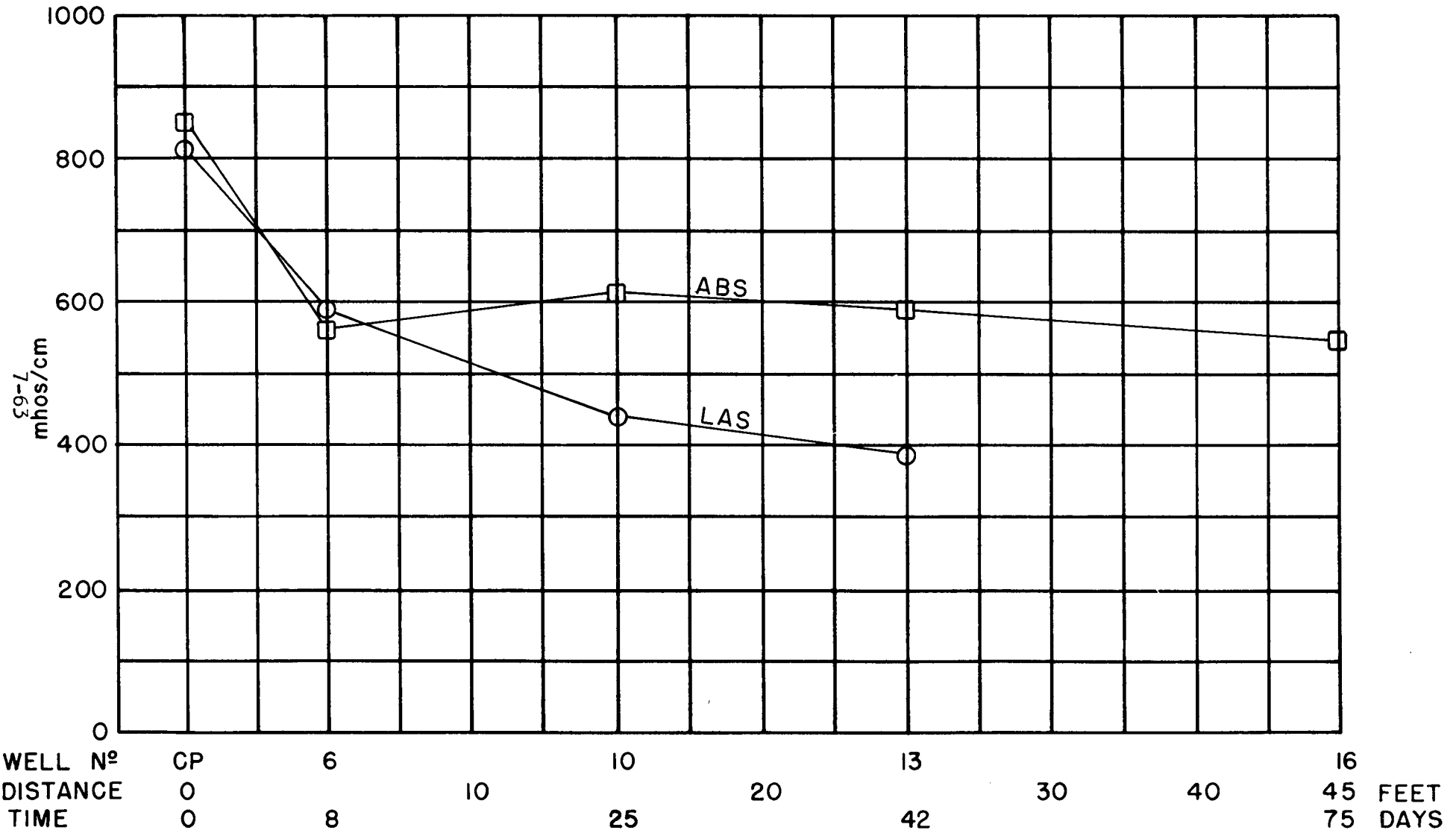
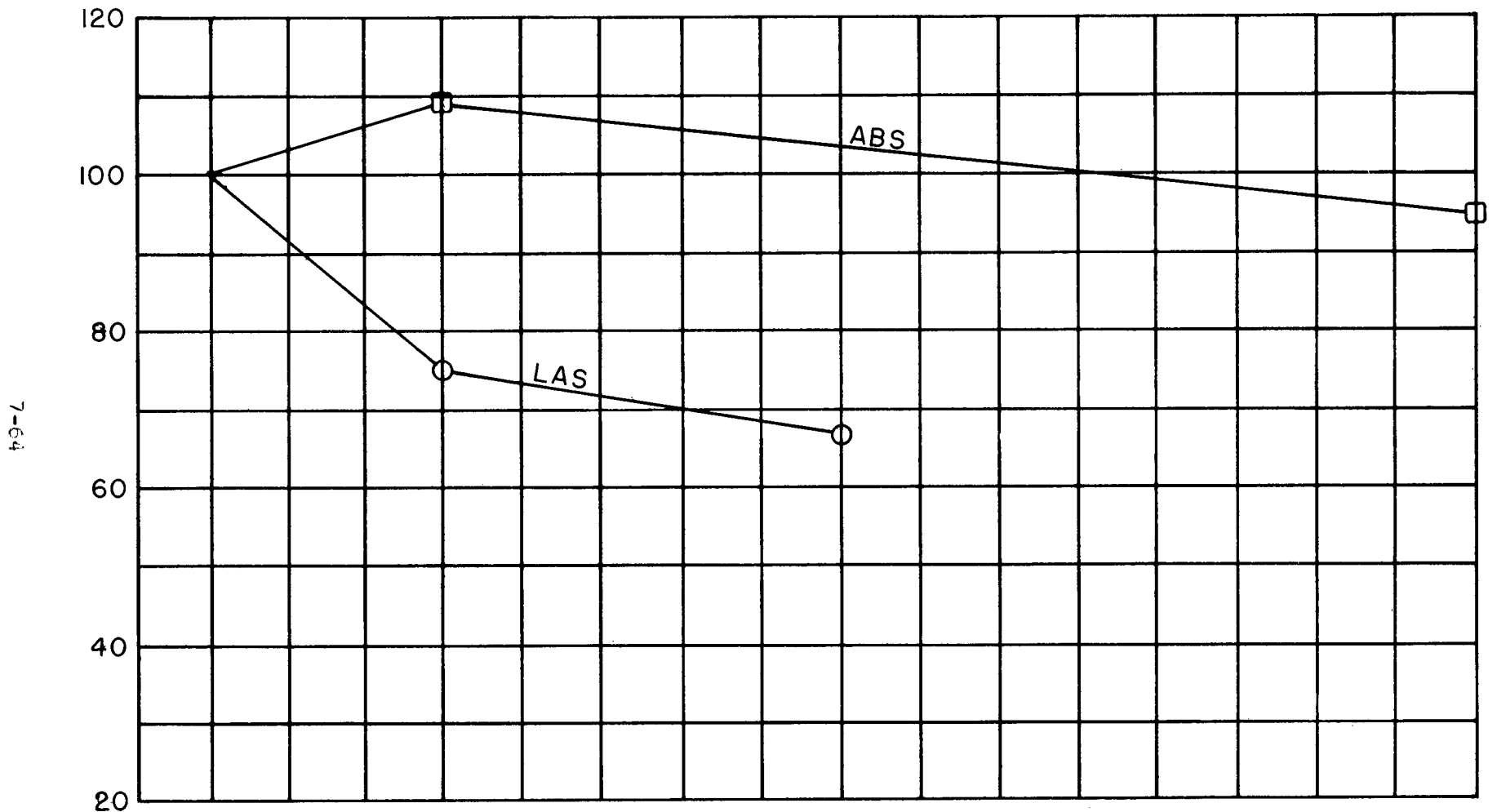

FIG. 7-27

LONG ISLAND GROUND WATER POLLUTION STUDY
 PERCENT REMAINING OF FIRST WELL CONCENTRATION
 SPECIFIC CONDUCTANCE (9/16/1963-1/24/1966)
 SITE N° 3 - BOHEMIA, SUFFOLK COUNTY, N. Y.



WELL N°	6	10	13	16
DISTANCE	0	10	20	40 FEET
TIME	0	17	34	68 DAYS

FIG. 7-28

rates of:

		<u>Average Values</u>	
ABS	Well #10 to #16	.07%/ft.	.04%/day
LAS	Well #6 to #13	.99	0.6

It is apparent that factors in addition to dilution contributed to reduction of specific conductance.

COD

1. The chemical oxygen demand, COD, in the disposal system averaged 191.0 mg/l during the use of ABS surfactant. (Table 7-1) Background observation wells indicated an average COD concentration of 15.0 mg/l throughout the sampling depth. (Table 4-1)
2. Movement of the waste through the unsaturated soil zone (cesspool to first well group) resulted in an overall reduction of 65.6 percent in COD during ABS usage. (Table 7-3 Figure 7-29, 30) COD reduction characteristics at the various sampling locations in the unsaturated zone were not determined; therefore, it could not be established if COD removal occurred in the initial few feet of unsaturated zone or uniformly throughout the zone.
3. In the saturated soil zone (first to last well groups), COD levels tended to increase in concentration and attain maximum levels at well group No. 13, 25 feet downstream from the cesspool. (Figure 7-29, 30) Beyond Well No. 13, COD levels decreased out to the final well group at the following rate:

		<u>Average Values</u>	
ABS	2.56%/ft.	1.54%/day	2.3 mg/l/ft.

Compensating for dilutional effects, based upon chloride reductions, through this limited flow path indicated net COD reduction rates of:

		<u>Average Values</u>	
ABS	2.21%/ft.	1.33%/day	

4. Apparently, based upon net COD reduction rates, factors besides that of dilution,

LONG ISLAND GROUND WATER POLLUTION STUDY
 REDUCTION VERSUS TRAVEL TIME
 COD (9/16/1963-1/4/1965)
 SITE N° 3 - BOHEMIA, SUFFOLK COUNTY, N. Y.

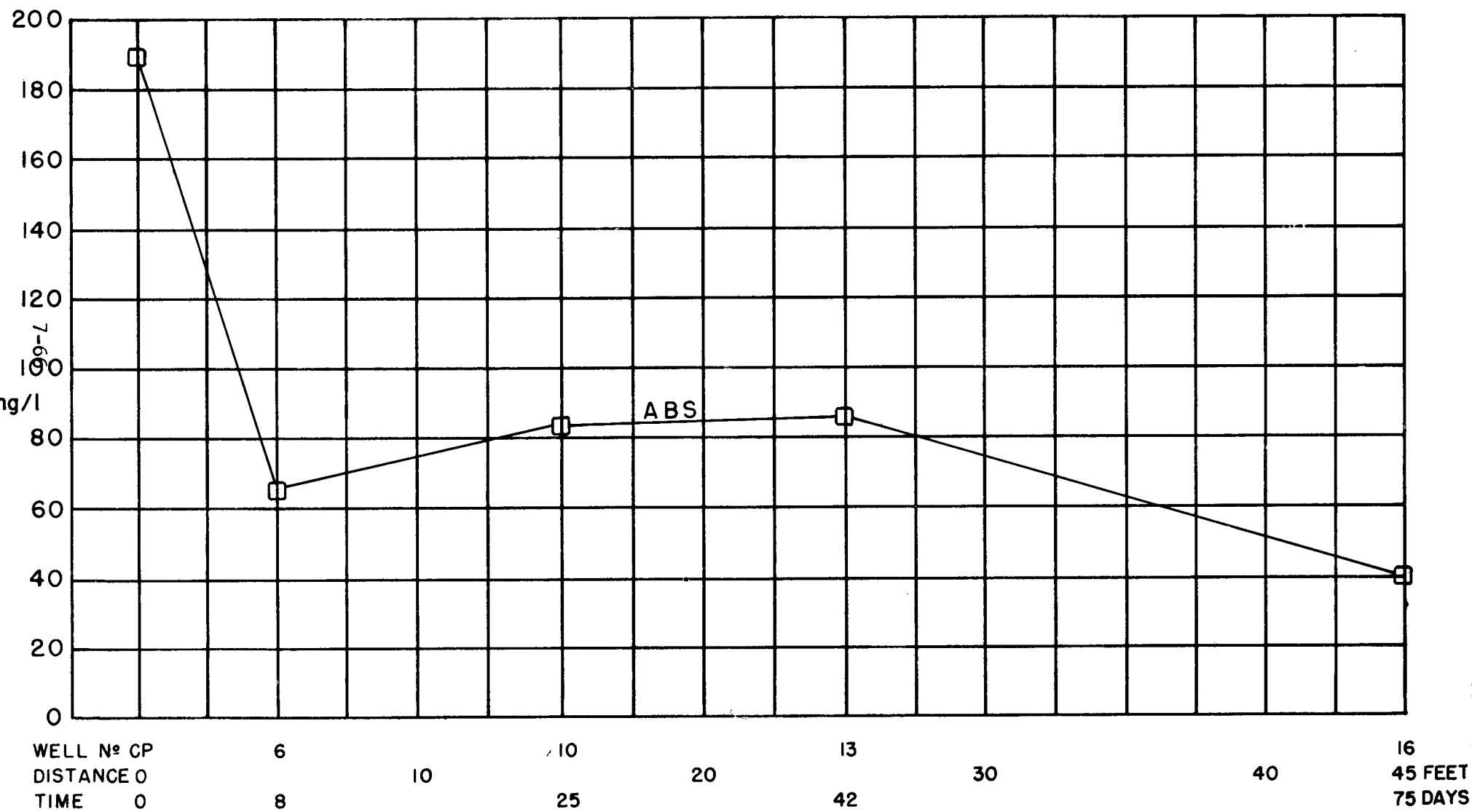

FIG. 7-29

LONG-ISLAND GROUND WATER POLLUTION STUDY
 PERCENT REMAINING OF FIRST WELL CONCENTRATION
 COD (9/16/1963-1/4/1965)
 SITE N^o 3 - BOHEMIA, SUFFOLK COUNTY, N. Y.

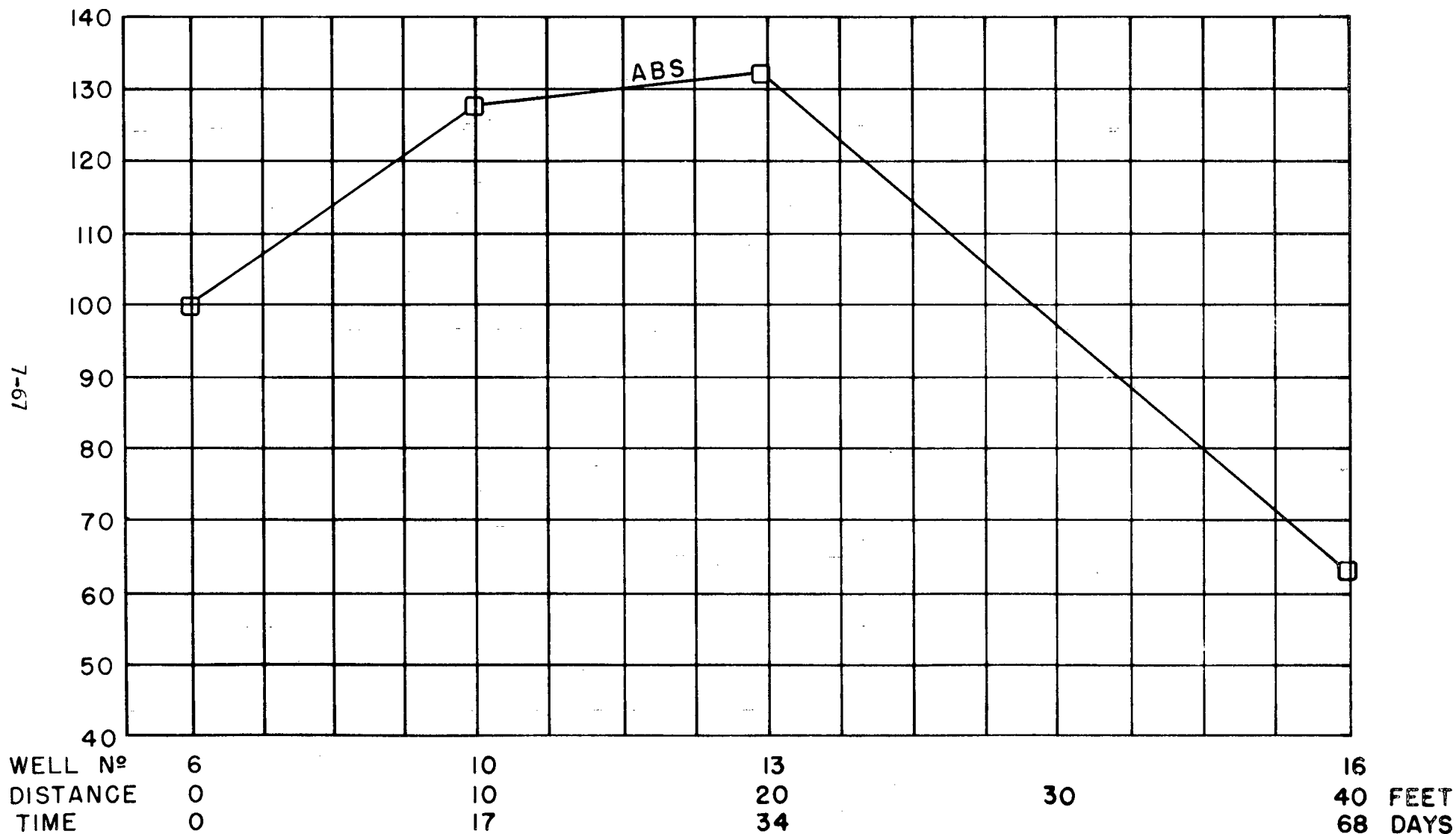

FIG. 7-30

aided in reducing COD concentrations in travel through a portion of the saturated soil zone.

BOD

1. Biochemical oxygen demand in the disposal system averaged 398 and 250 mg/l during the use of ABS and LAS surfactants, respectively.
2. The ratio of BOD/COD in the cesspool indicated that laboratory errors may have occurred in the determinations.

	<u>BOD</u>	<u>COD</u>	<u>BOD/COD</u>
ABS	398 mg/l	191 mg/l	2.08
LAS	250	----	----

Generally, for domestic sewage a BOD/COD ratio greater than 1.0 should not exist.

3. BOD values and total suspended solids in the disposal system varied greatly with BOD levels being generally higher.

Total and Suspended Solids

1. Total and suspended solids in the cesspool during the use of ABS and LAS surfactants varied.

	<u>Total Solids</u>	<u>Suspended Solids</u>	<u>BOD</u>
ABS	668 mg/l	250 mg/l	398 mg/l
LAS	476	186	250

2. The use of ABS surfactant resulted in the largest BOD total and suspended solids levels in the disposal system.

LONG ISLAND GROUND WATER POLLUTION STUDY
 REDUCTION VERSUS TRAVEL TIME
 ABS IN USE (9/16/1963 - 1/4/1965)
 SITE N° 3 - BOHEMIA, SUFFOLK COUNTY, N. Y

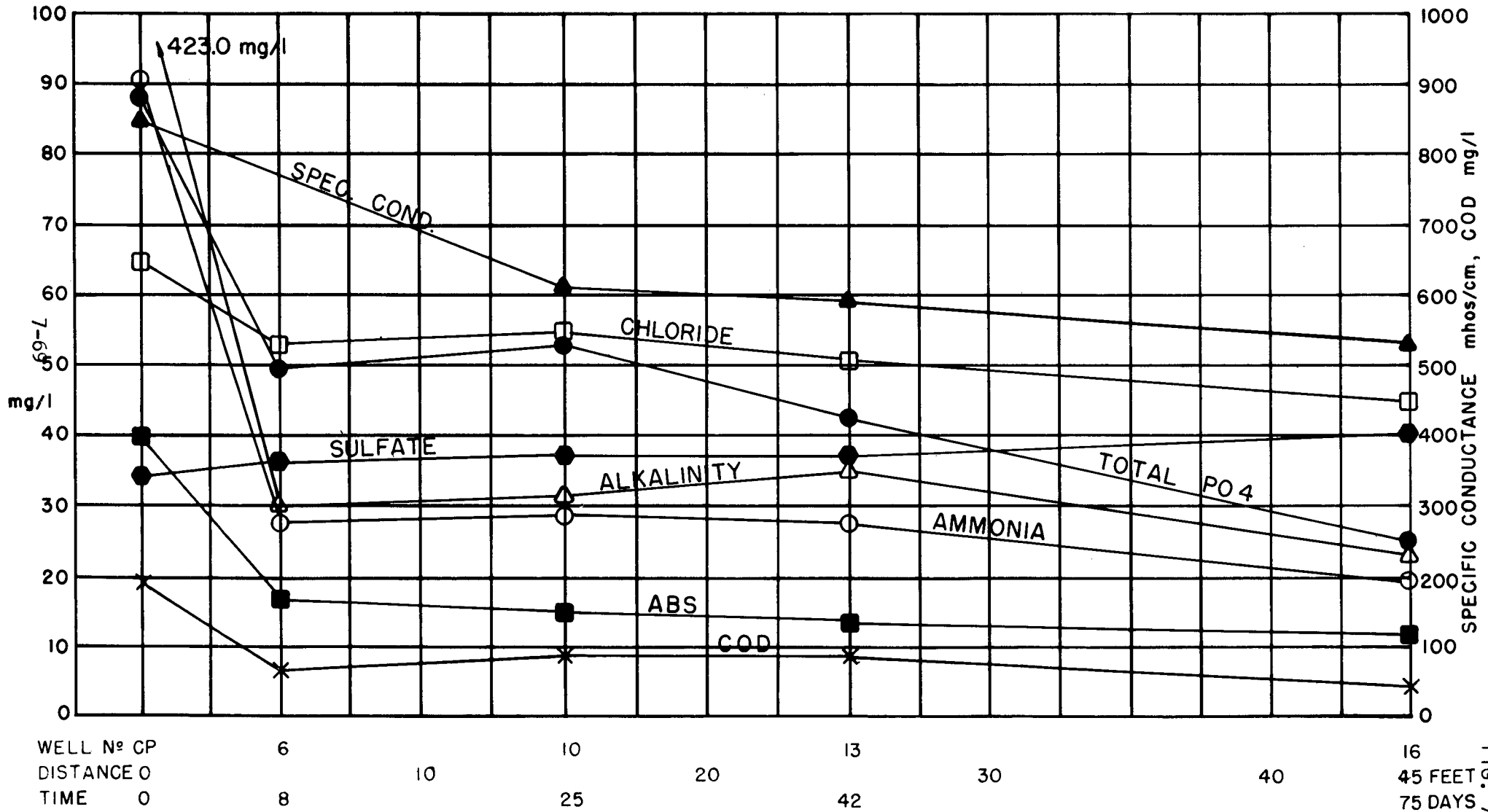

FIG. 7-31

LONG ISLAND GROUND WATER POLLUTION STUDY
 PERCENT REMAINING OF FIRST WELL CONCENTRATION
 ABS IN USE (9/16/1963-1/4/1965)
 SITE N° 3 - BOHEMIA, SUFFOLK COUNTY, N. Y.

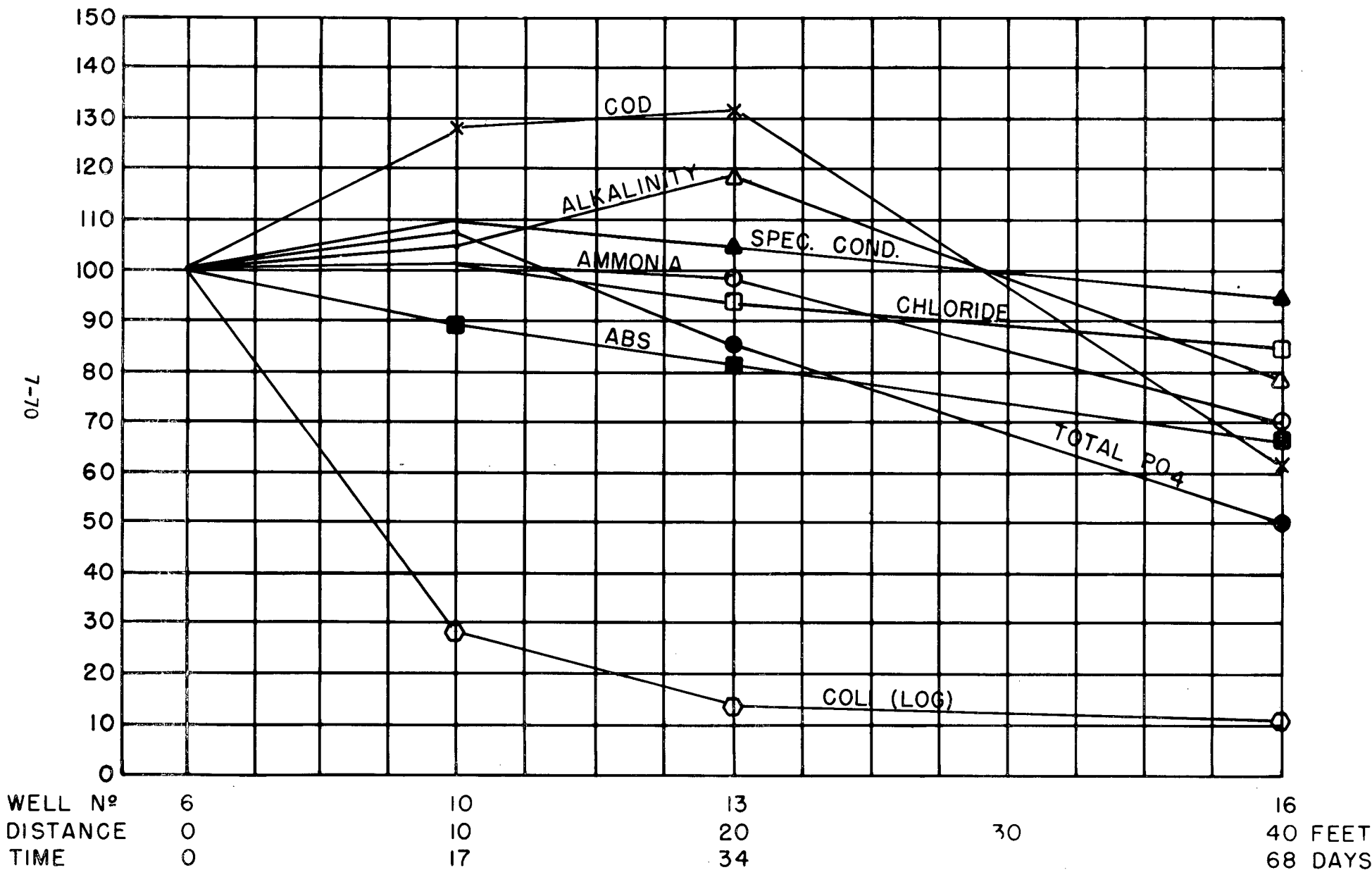

FIG. 7-32

LONG ISLAND GROUND WATER POLLUTION STUDY
 REDUCTION VERSUS TRAVEL TIME
 LAS IN USE (1/4/1965 - 1/24/1966)
 SITE N° 3 - BOHEMIA, SUFFOLK COUNTY, N. Y.

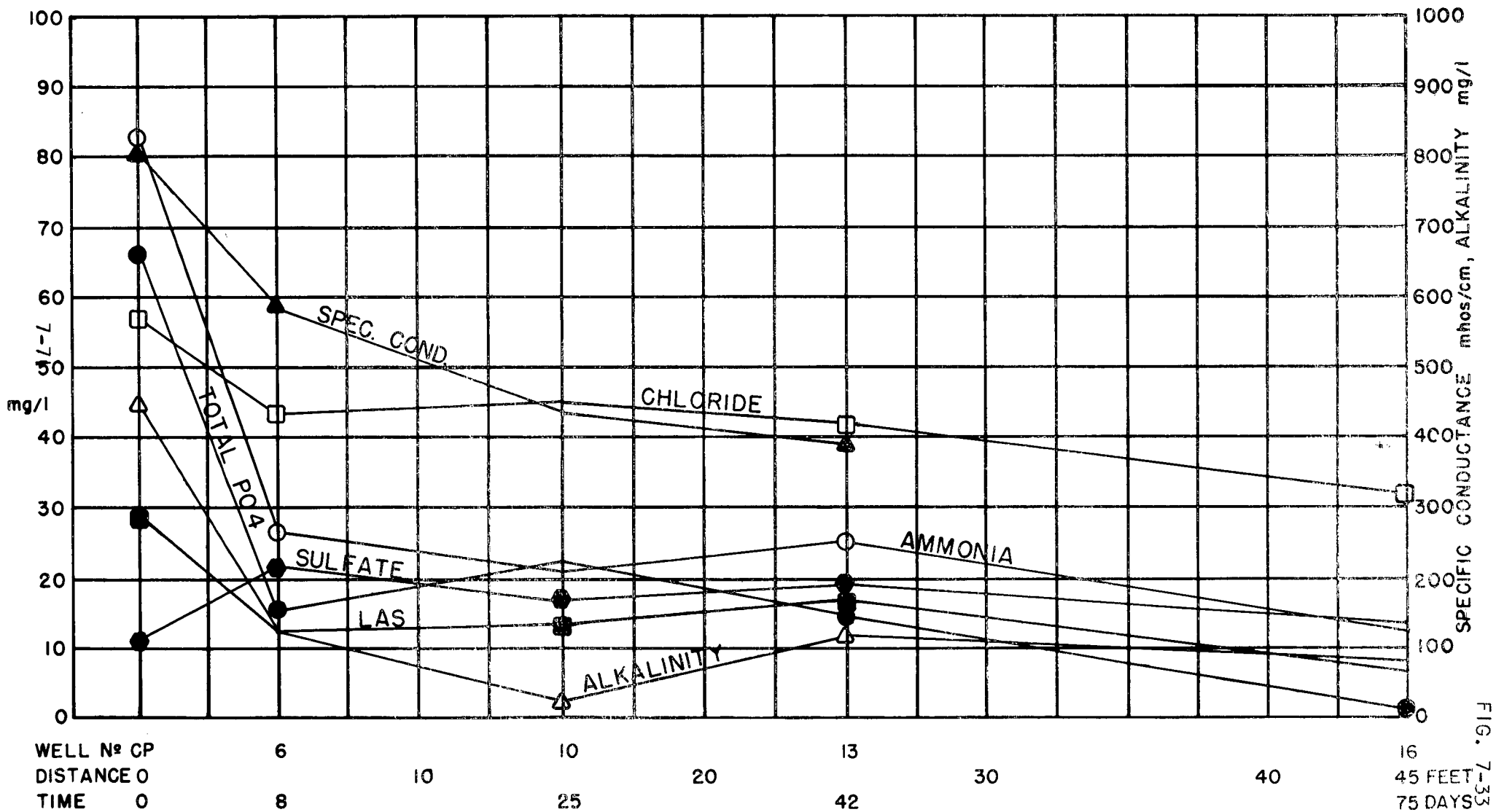

FIG. 7-33

LONG ISLAND GROUND WATER POLLUTION STUDY
 PERCENT REMAINING OF FIRST WELL CONCENTRATION
 LAS IN USE (1/4/1965-1/24/1966)
 SITE N° 3 - BOHEMIA, SUFFOLK COUNTY, N. Y.

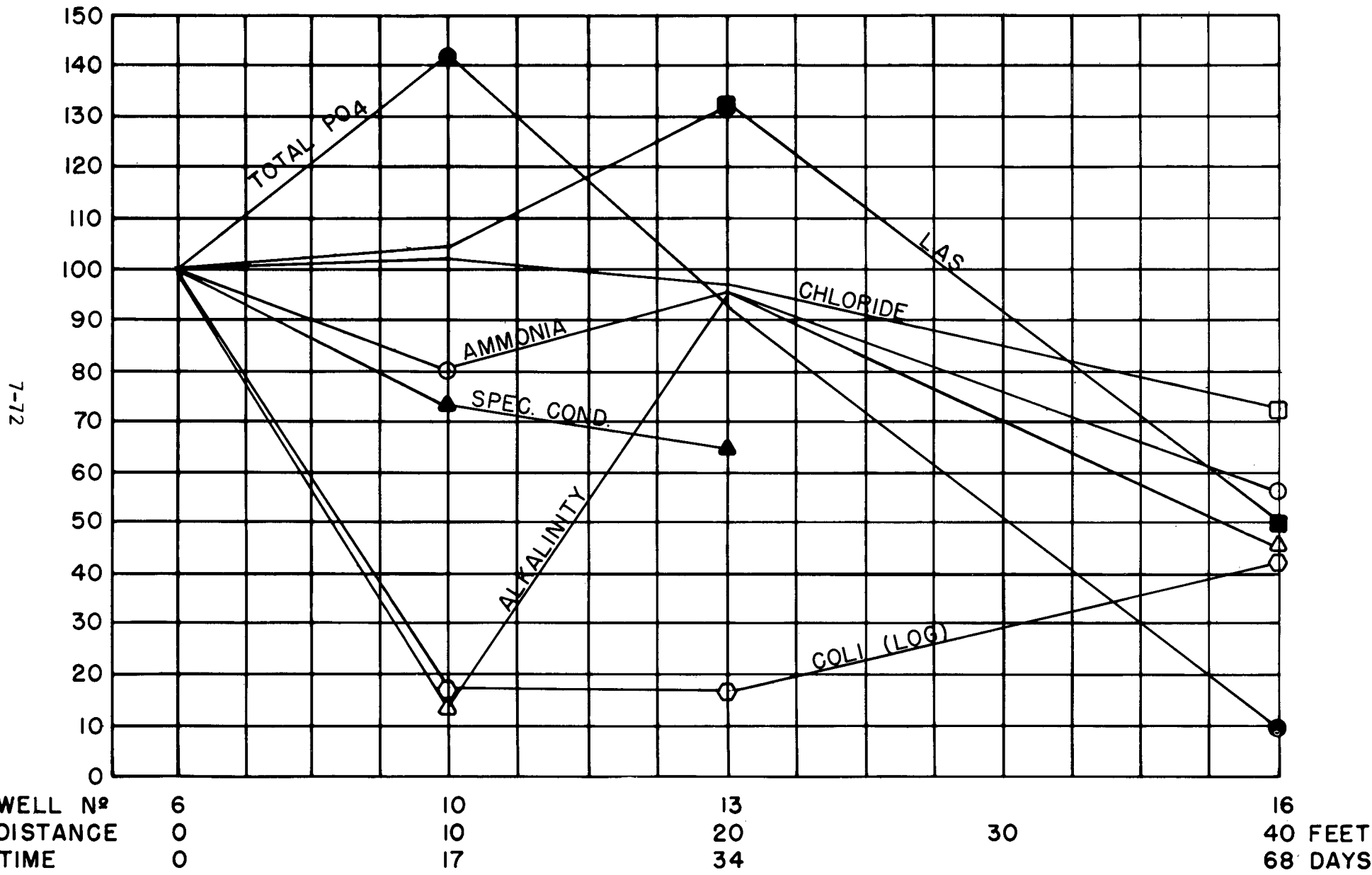

FIG. 7-34

PART 8 - SITE 4

Description and Development

This site is located on the west side of Kennedy Avenue, 270 feet south of Oakwood Street in the hamlet of Blue Point, Township of Brookhaven in Suffolk County. The parcel is a plot 115 feet in frontage by 150 feet deep on the glacial outwash plain approximately 1 1/4 miles north of Great South Bay. The resident family consists of 2 adults and 2 children.

Initial preparations on this site were commenced in November of 1963. The home is supplied with public water from the Patchogue District of the Suffolk County Water Authority. The nearest well field of the Authority is 1 1/2 miles west, on Lakeview Avenue, Bayport, consisting of a 9-acre plot containing 3 glacial production wells and 1 Magothy well. The water produced at this station is of excellent sanitary and chemical quality, very soft, with iron and manganese concentrations less than 0.2 ppm and treated to a pH above 7.2 by the addition of hydrated lime, chlorinated to a residual of 0.2 ppm, and with MBAS levels less than 0.15 mg/l.

Weekly readings of the water meter indicated an average use of 1100 gallons per week. The homeowner had been using commercial washing compounds which, according to manufacturers representatives, contained a branched chained anionic surfactant. On December 4, 1963, the homeowner was supplied with the formulation containing coconut oil tallow and tall oil soaps.

The sewage disposal system consists of two cesspools 8 feet in diameter and 7 feet deep, each constructed of a 3 1/2 feet deep precast leaching section surmounted by a 3 1/2 feet deep precast leaching dome. The bottom of each pool is approximately 9 feet above static water. The first pool received all of the wastes from the kitchen, clotheswasher and 2 bathrooms. The second pool, constructed as an overflow, did not receive any wastes during the conduct of the study at this site since the first pool was still functioning satisfactorily. A test boring approximately 40 feet deep indicated the subsoils consist of fine sand with traces of silt and minor amounts of small gravel. Static water level was determined to be 17 feet, 8 inches below grade.

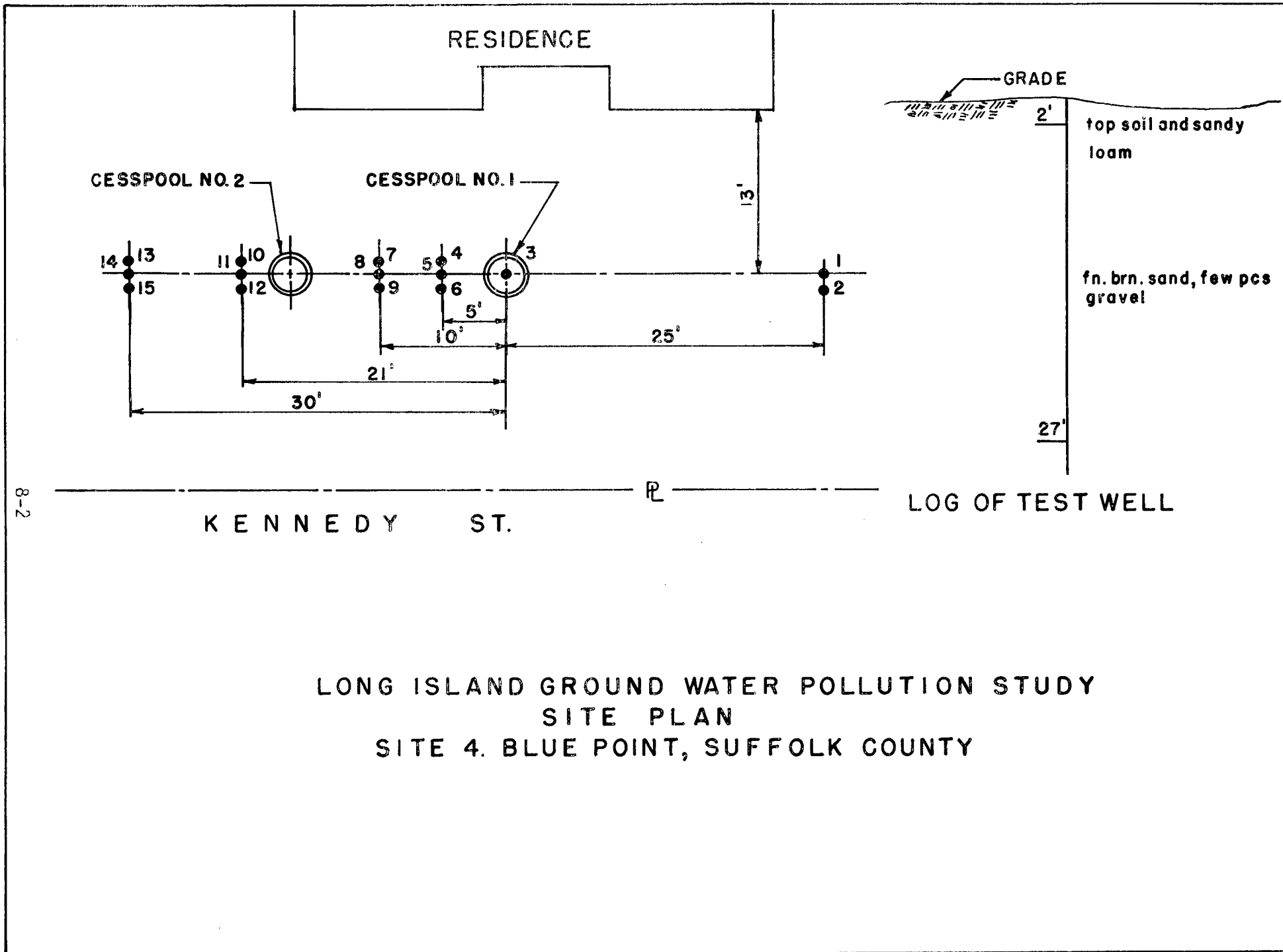

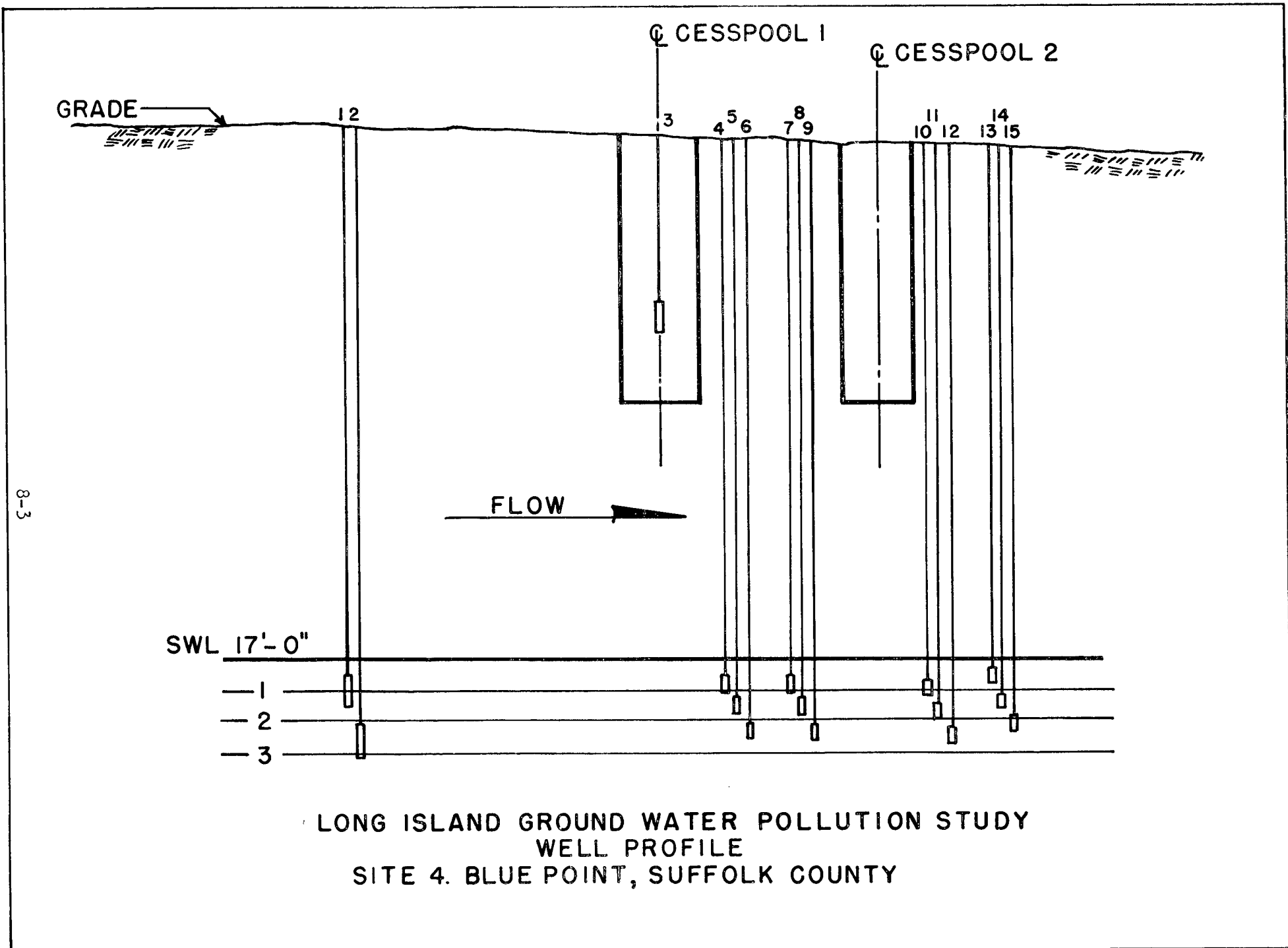

Temporary observation wells were driven at the corners of the plot and static water levels and slope of the water table determined. The gradient established indicated ground water flow at approximately S 10° E. Several probe wells were driven along this flow-line and sampled at various depths to locate the sewage slug. Samples retrieved were examined in the field for methylene blue active substances. Due to the low concentrations detected, apparently because of the unusual subsoils underlying this site, confirmation that the observation wells were located within the slug was obtained by determinations of alkalinity and specific conductivity measurements in the field. Subsequent analyses for nitrates levels, which were substantially higher than background wells, also confirmed that the well screens were properly positioned.

On October 7, 1964, Mr. D.L. Warner and Mr. T.W. Bendixen of the U.S. Public Health Service made measurements of earth resistivity on this site, confirming the direction of flow of the wastes emanating from the first cesspool. Fifteen wells were placed in this directional line, using three for background and the remaining in four groups of 3 wells at distances of 5 feet, 10 feet, 21 feet and 31 feet from the center of the pool. (Figure 8-1, 2) It is now apparent from the results of analyses that well No. 4, nearest the cesspool was not in proper position to intercept the sewage slug since the determinations for virtually all constituents yielded higher values at wells further distant.

Several unsuccessful attempts were made to determine ground water velocity at this site. Sodium fluoride was introduced into the cesspool to produce a concentration of 1200 ppm of fluoride ion. Daily samples collected from the well immediately adjacent to the wall of the pool failed to demonstrate a significant concentration. A subsequent attempt, using a still higher dosage also failed. It was concluded that either well No. 4 was not accurately positioned in the sewage slug or that unusual soil conditions at this site resulted in adsorption or other method of removal of the fluoride ion.

The homeowner had been using a branched chained surfactant prior to the study, so that it was assumed that the cesspool environment and the subsoils were saturated with ABS materials. A soap product was then used for a 16-week period with an average use of 1.4 pounds per week. From March 9, 1964 to June 28, 1965, the homeowner then used the straight-chain material or LAS for a total of 76 weeks with an average use of 1.4 pounds per week.

Travel of Waste Slug

1. A distinct sewage slug was observed as the waste traveled through the downstream saturated soil zone.
2. The waste slug at the first downstream sampling well, after traveling through approximately 9 feet of unsaturated sands, had its peak concentrations of contaminants of sewage origin located approximately 1 foot below the static water level. As the waste slug proceeded downstream, the location of the peak concentrations within the slug remain relatively constant with respect to the SWL, i.e., at 1 foot below SWL.
3. The density of the waste slug in travel through about 9 feet of unsaturated silty sands was reduced to a level where the difference in density between the waste slug and ground water was not sufficient to result in depression of the sewage slug through the downstream flow path.
4. Natural recharge and infiltration by precipitation did not appear to have any direct affect on either depressing the waste slug or resulting in additional dilution.
5. As the waste slug proceeded through the downstream sampling locations, the concentration of contaminants of sewage origin generally decreased with each succeeding downstream well group.
6. There did not appear to be any indication of contamination from upgradient sources.

Chlorides

1. Average chloride concentrations in the disposal system during the use of

soap was 73.0 mg/l and 61.5 mg/l during LAS usage. (Table 8-1) Background wells had an average chloride concentration of 13.5 to 25.5 mg/l.

2. Travel in the unsaturated soil zone, cesspool to first well group, resulted in overall chloride reductions of 63 and 19.8 percent during the use of Soap and LAS, respectively. (Table 8-1, 2) The average rates of reduction in chloride concentrations through the unsaturated zone (12 feet vertical travel distance) was:

Average Values

Soap	5.25%/ft.	3.83 mg/l/ft.
LAS	1.65	1.02

3. The change in chloride concentration through the downstream sampling locations varied with the use of Soap and LAS surfactants. During the use of Soap, chlorides tend to increase in concentration between the first well group No. 4 and the well group No. 10, 21 feet downstream from the disposal system. Beyond well group No. 10, chlorides decreased at rapid rate out to the last observation well group. Chloride concentrations during the use of LAS surfactant decreased significantly between the first and second well groups (No. 4-7), a distance of 5 feet, then remained relatively constant to the last observation well group. An average rate of chloride reduction through the downstream saturated zone could not be determined. (Figure 8-3, 4, 15, 16)

MBAS and ABS

1. MBAS reported as ABS in the cesspool varied with the surfactant being used averaging 1.4 and 28.8 mg/l during the use of Soap and LAS, respectively. (Table 8-1)

All background observation wells had a low MBAS level averaging 0.04 mg/l. (Table 4-1)

2. Vertical travel through the unsaturated soil zone resulted in a 99.3 percent reduction in MBAS during the use of LAS surfactant. (Table 8-1) Soap usage indicated a 7.1 percent increase in MBAS concentration in travel through the unsaturated soil area. The increase in MBAS level during the use of Soap was undoubtedly due to

SITE #4

OBSERVATION WELL CONCENTRATIONS

TABLE 8-1

V = Not established

	Cesspool 0	#4 5'	#7 10'	#10 21'	#13 31'
1. Soap (MBAS)	1.4	1.5	6.1	2.7	0.6
Ammonia	115.0	5.2	16.2	21.0	1.0
Chlorides	73.0	27.0	47.3	51.0	16.1
Total PO ₄	56.9	4.6	25.4	5.5	0.09
Spec. Cond.	914.0	289.4	455.6	587.5	220.7
Alkalinity	549.3	18.1	22.1	31.3	13.6
Sulfates	11.8	21.7	39.3	37.7	17.9
Coliform (Log Aug)	6.31 x 10 ⁶	76.7	730.0	3.6	17.4
Nitrites	0.01	0.12	0.14	0.08	0.08
Nitrates	0.10	26.5	43.4	59.0	20.3
COD	207.0	17.8	39.4	22.4	18.2
2. LAS (MBAS)	28.8	0.19	0.82	1.49	0.35
Ammonia	94.0	0.55	2.9	10.0	0.77
Chlorides	61.5	49.3	23.6	27.6	24.6
Total PO ₄	81.5	0.70	4.7	11.2	0.17
Spec. Cond.	953.0	146.0	214.0	343.0	188.0
Alkalinity	440.0	20.6	20.1	40.7	16.5
Sulfates	51.2	34.7	39.0	41.0	32.7
Coliform (Log Aug.)	3.51 x 10 ⁶	464.0	1037.0	192.0	169.0
Nitrites	0.02	0.40	0.97	1.24	0.42
Nitrates	0.95	5.7	13.0	25.8	11.0
COD					

SITE #4

PERCENT REMAINING OF FIRST WELL CONCENTRATIONS

TABLE 8-2

	Cesspool to #4	#4 0	#7 5'	#10 16'	#13 26'
i. Soap (MBAS)	107.1	100.0	+307.0	+180.0	40.0
Ammonia	4.5		+212.0	+306.0	19.2
Chlorides	37.0		+175.0	+189.0	59.6
Total PO ₄	7.5		+452.0	+119.6	2.0
Spec. Cond.	31.7		+157.5	+199.5	68.9
Alkalinity	3.0		+122.1	+173.0	66.9
Coliform	0.1		+850.0	4.7	22.7
(Log Aug.)					
COD	8.7		+121.0	+126.0	+102.3
2. LAS (MBAS)	0.7	100.0	+331.0	+683.0	+184.0
Ammonia	0.9		+383.0	+1565.0	+128.0
Chlorides	80.2		47.9	56.0	49.9
Total PO ₄	1.0		+571.0	+1500.0	24.3
Alkalinity	5.0		97.6	+197.5	80.1
Coliform	0.1		+124.0	+142.0	+174.0
(Log Aug.)					
COD					

LONG ISLAND GROUND WATER POLLUTION STUDY
REDUCTION VERSUS TRAVEL TIME
CHLORIDES (12/4/1963-6/28/1965)
SITE N° 4 - BLUE POINT, SUFFOLK COUNTY, N. Y.

6-8

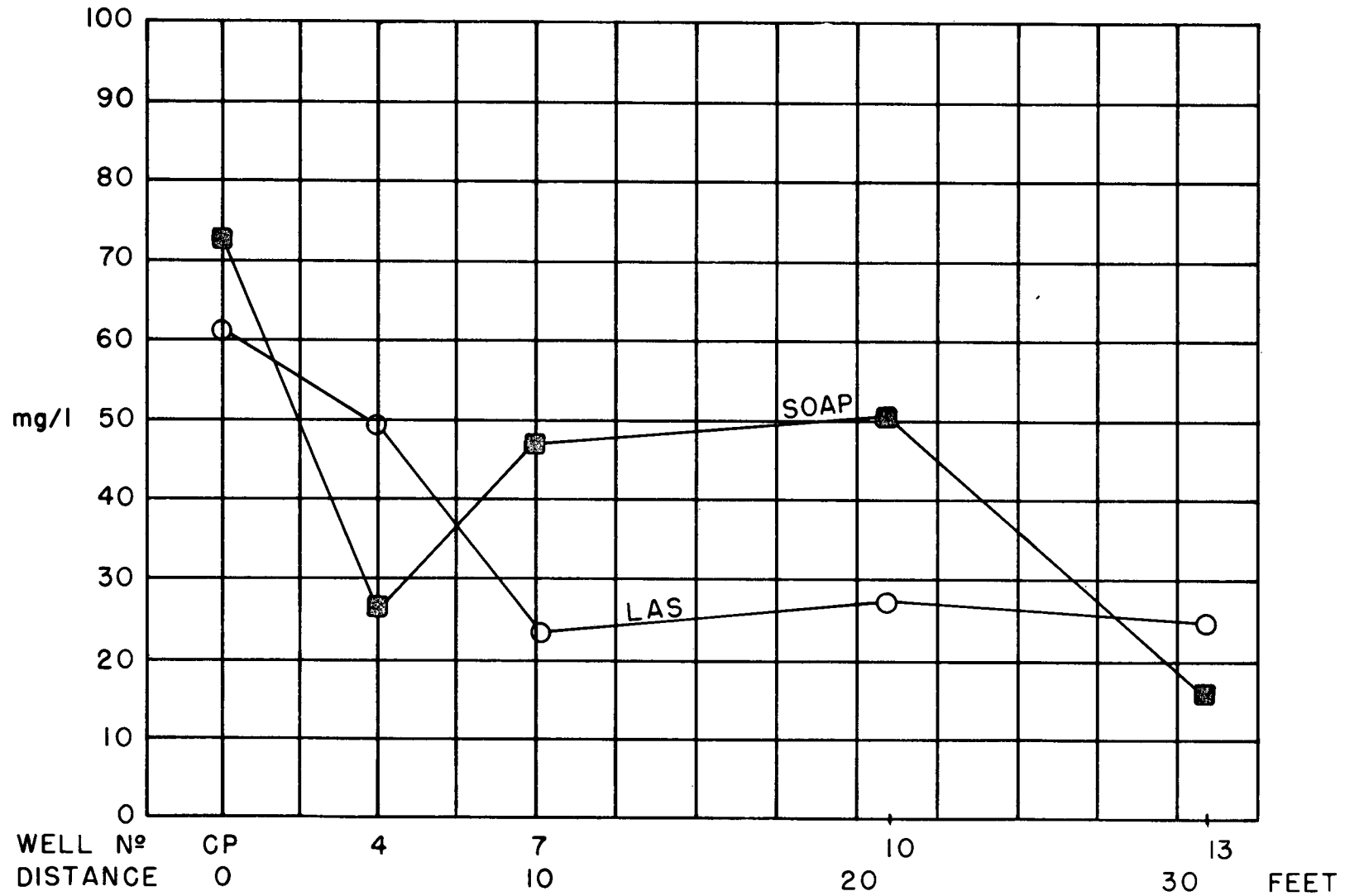
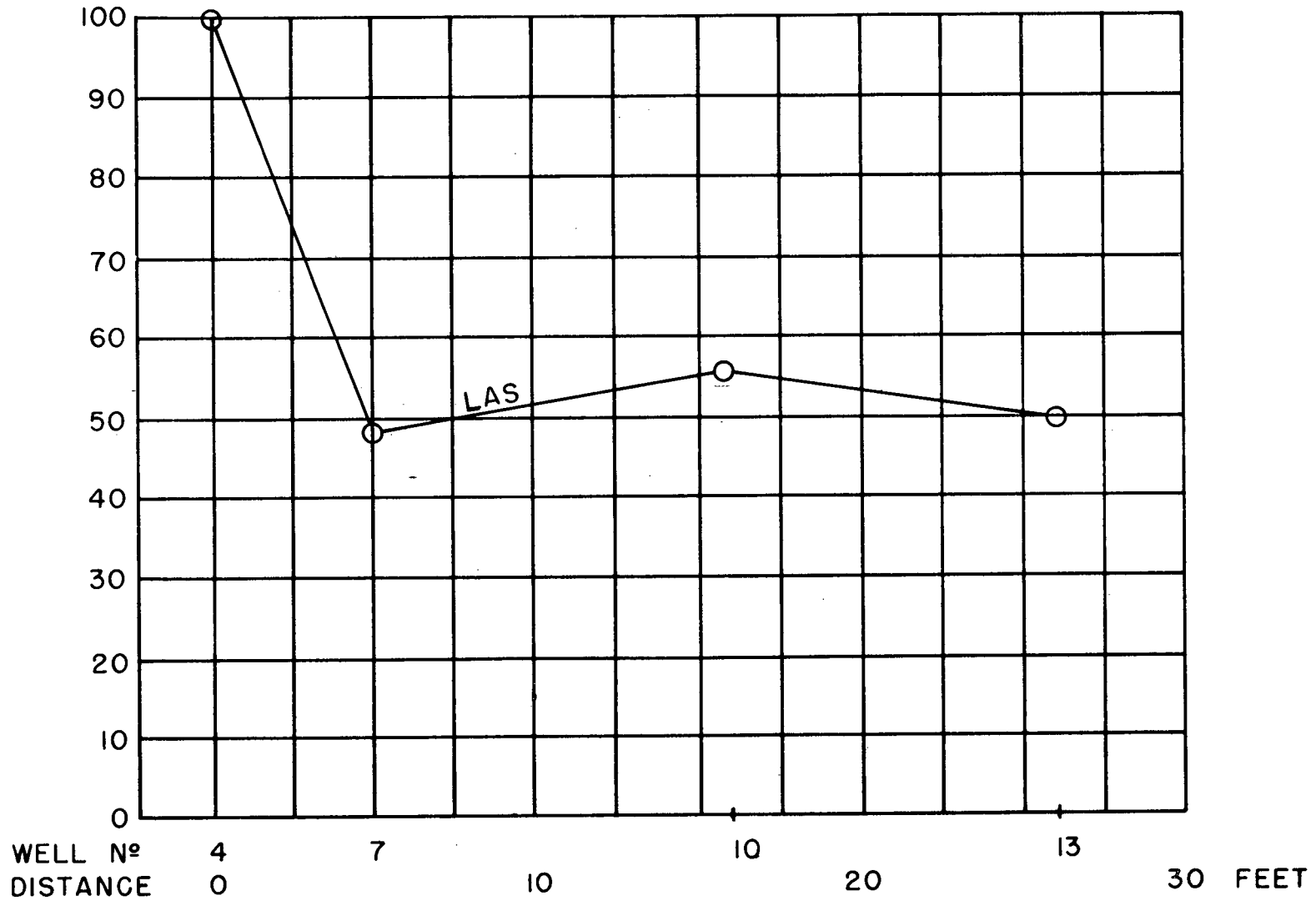

FIG. 8-3

LONG ISLAND GROUND WATER POLLUTION STUDY
PERCENT REMAINING OF FIRST WELL CONCENTRATION
CHLORIDES (3/9/1964-6/28/1965)
SITE N° 4 - BLUE POINT, SUFFOLK COUNTY, N.Y.



8-10

FIG. 8-4

branched material, ABS, being desorbed from the unsaturated soil zone.

3. Infrared analysis for the percent branched material was not performed on this site. Prior to initiation of the studies, the household was using ABS surfactant as the washing compound; and therefore, the waste slug flow path was initially saturated with ABS material. (Table 8-2 Figure 8-5)

4. In travel through the unsaturated soil zone, Soap and LAS surfactants had overall average rates of MBAS reduction (12 feet travel distance) of:

	<u>Average Values</u>	
Soap	0%/ft.	0 mg/l/ft.
LAS	8.26	2.38

5. Sampling devices were not installed in the unsaturated zone to monitor the waste slug in its vertical travel between the cesspool and first well group; therefore, reduction in MBAS at various levels of the unsaturated soil area was undeterminable. It is believed that a large portion of the MBAS reduction occurred in the initial cesspool - unsaturated soil region.

6. Since dilution of the waste slug by infiltrating rain waters in the unsaturated zone is negligible, the reduction of MBAS in this soil area must be due to sorption and/or degradation more so than by dilution.

7. Average rates of MBAS reduction through the saturated soil zone could not be established due to increasing MBAS concentrations to well groups No. 7 and No. 10 followed by decreasing MBAS levels out to the final well group. (Figure 8-5) It was suspected that branched material, ABS, being desorbed from the soil strata resulted in interferences in MBAS determinations during the use of Soap and LAS surfactant.

8. Downstream MBAS levels during the use of Soap and LAS were extremely low averaging between 0.19 and 6.1 mg/l MBAS as ABS. The large reduction in the unsaturated soil zone and low MBAS levels in the saturated zone was concluded to be attributed to the unusual soil conditions on this site. The subsoils on this site are fine silty sands in contradistinction to the coarser sands and

LONG ISLAND GROUND WATER POLLUTION STUDY
REDUCTION VERSUS TRAVEL TIME
MBAS REPORTED AS ABS (12/4/1963 - 6/28/1965)
SITE N° 4 - BLUE POINT, SUFFOLK COUNTY, N. Y.

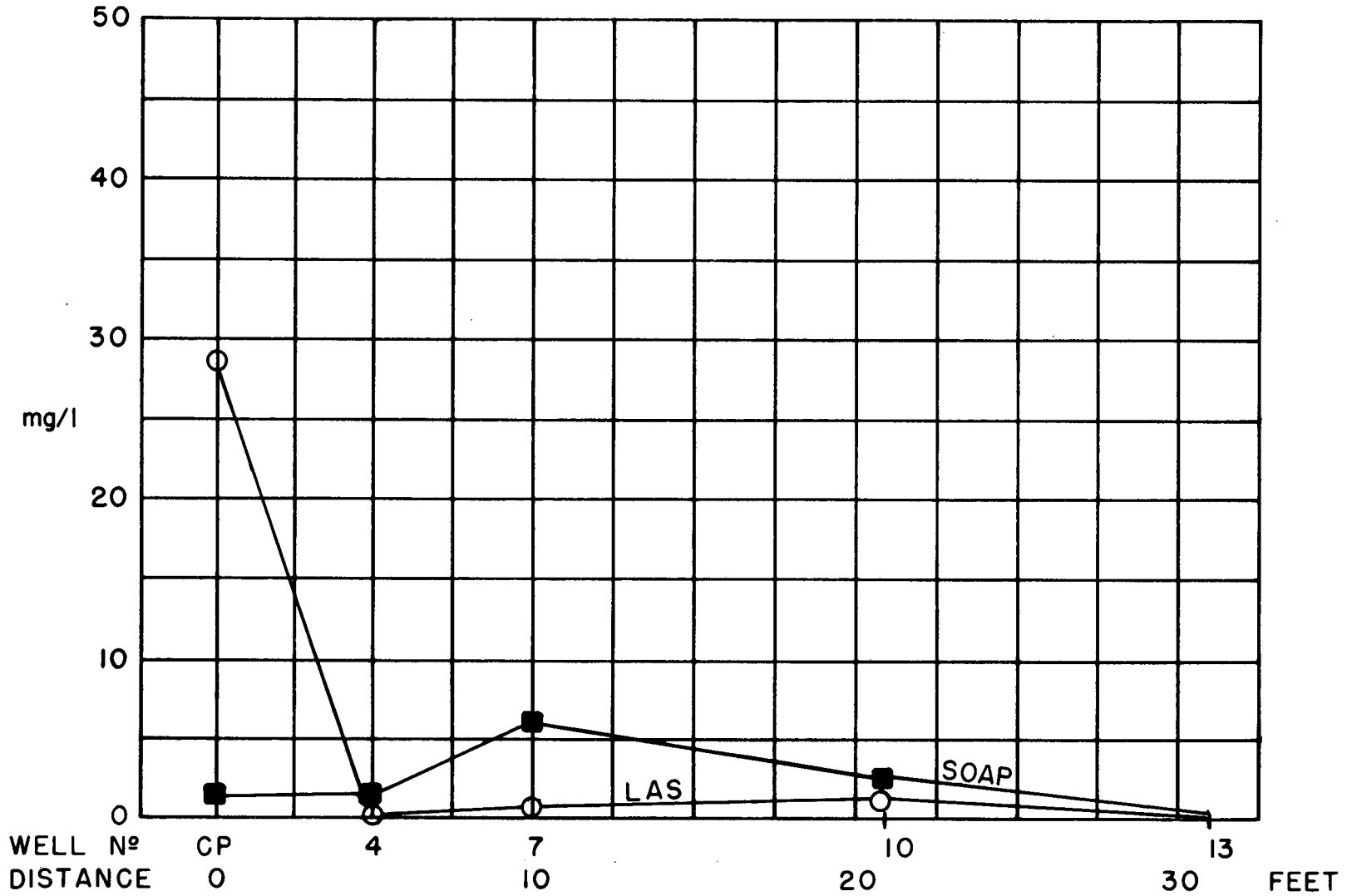

8-12

FIG. 8-5

gravels encountered on the other sites.

9. In the unsaturated zone where LAS surfactant had a 99.3 percent reduction in MBAS concentration bacterial populations also had a drastic reduction with the log average coliform concentrations being reduced by more than 99.9 percent during the use of both Soap and LAS surfactant. (Figure 8-11 Table 8-1, 2)

Dissolved Oxygen

1. Dissolved oxygen concentrations in both upgradient and downstream sampling locations were high being about 3.3 to 6.4 mg/l. Generally, downstream wells were higher in dissolved oxygen than the background wells. (Table 4-5)

2. Background wells exhibited dissolved oxygen levels of 4.0 and 4.2 mg/l. There was no evidence of a background waste slug on this site, thus the upgradient ground waters were relatively unpolluted. The downstream dissolved oxygen levels were not indicative of the presence of a sewage slug, although chemical and bacteriological analyses indicated presence of a waste slug.

pH

1. In the disposal system the average pH ranged between pH 6.6 and 7.7. Although the upgradient wells were free from sewage pollution, they exhibited a range, pH 5.5 to 6.3, while downstream observation wells had a more significant variation, pH 4.5 to 6.2.

Ammonia

1. Free ammonia concentrations in the cesspool averaged 115.0 and 94.0 mg/l during the use of Soap and LAS surfactant, respectively. (Table 8-1) All background observation wells exhibited a uniform free ammonia level of 0.14 mg/l.

2. Extremely large reductions 95.5 and 99.1 percent in free ammonia concentration occurred in travel of the waste slug through the unsaturated soil zone during the use of Soap and LAS materials. (Table 8-1, 2 Figure 8-6)

3. Ammonia reduction characteristics were not determined in movement through

LONG ISLAND GROUND WATER POLLUTION STUDY
REDUCTION VERSUS TRAVEL TIME
AMMONIA (12/4/1963-6/28/1965)
SITE N° 4 - BLUE POINT, SUFFOLK COUNTY, N.Y.

8-14

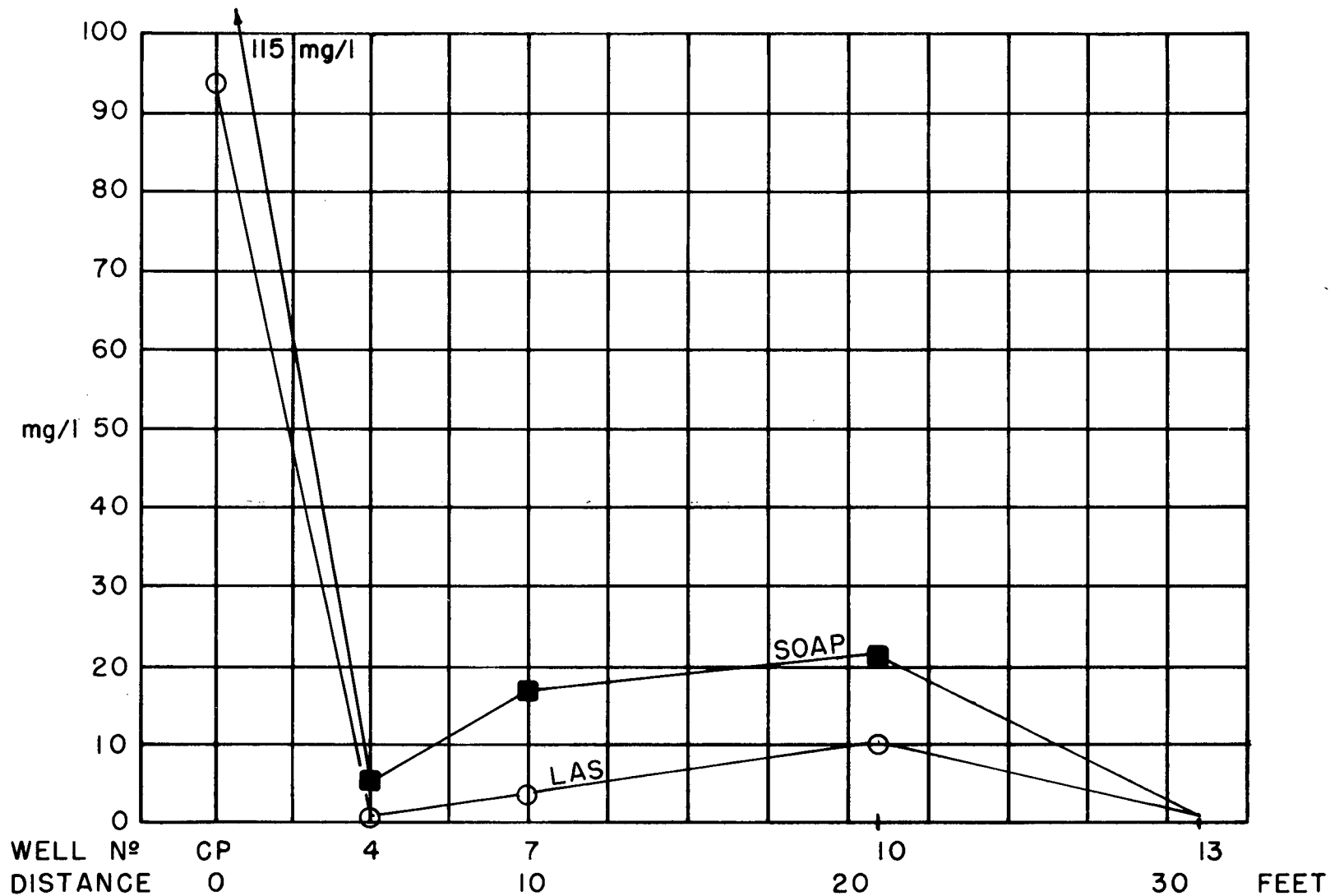

FIG. 8-6

the saturated soil zone.

4. Travel of the sewage slug through the downstream saturated soil zone resulted in increasing ammonia concentrations to well group No. 10, 21 feet downstream from the disposal system. Beyond well group No. 10 a relatively rapid decrease in ammonia resulted out to the last well group No. 10 during the use of both surfactants. (Figure 8-6, 7, 8)

5. Overall reductions in free ammonia of 99.9 percent resulted between the cesspool and last well group during the use of Soap and LAS. (Figure 8-6, 7, 8) Greatest ammonia removals resulted in travel of the slug through the unsaturated zone.

Nitrites

1. Nitrite levels in the disposal system were relatively constant during the use of Soap and LAS being 0.01 and 0.02 mg/l, respectively. (Table 8-1) All background wells had an average nitrite concentration of about 0.07 mg/l.

2. Although information could not be attained on the advancement of the nitrogen cycle through the unsaturated soil zone, it was anticipated that maximum nitrite levels actually developed in the unsaturated zone and not the downstream wells. (Figure 8-7, 8)

Nitrates

1. Nitrate concentrations in the disposal system varied being 0.1 and 0.95 mg/l during the use of Soap and LAS surfactants, respectively. (Table 8-1) Upstream observation wells indicated significant nitrate levels of 4.8 to 10.8 mg/l.

2. It is expected that maximum nitrate concentrations actually developed in the unsaturated zone prior to the first downstream observation wells. Analytical results as to the changes in the nitrogen cycle through the unsaturated zone was not determined.

3. In the downstream saturated zone, a secondary increase in nitrate levels

LONG ISLAND GROUND WATER POLLUTION STUDY
 NITROGEN CYCLE VERSUS TRAVEL TIME
 SOAP IN USE (12-4-'63 / 3-9-64)
 SITE 4. BLUE POINT, SUFFOLK COUNTY

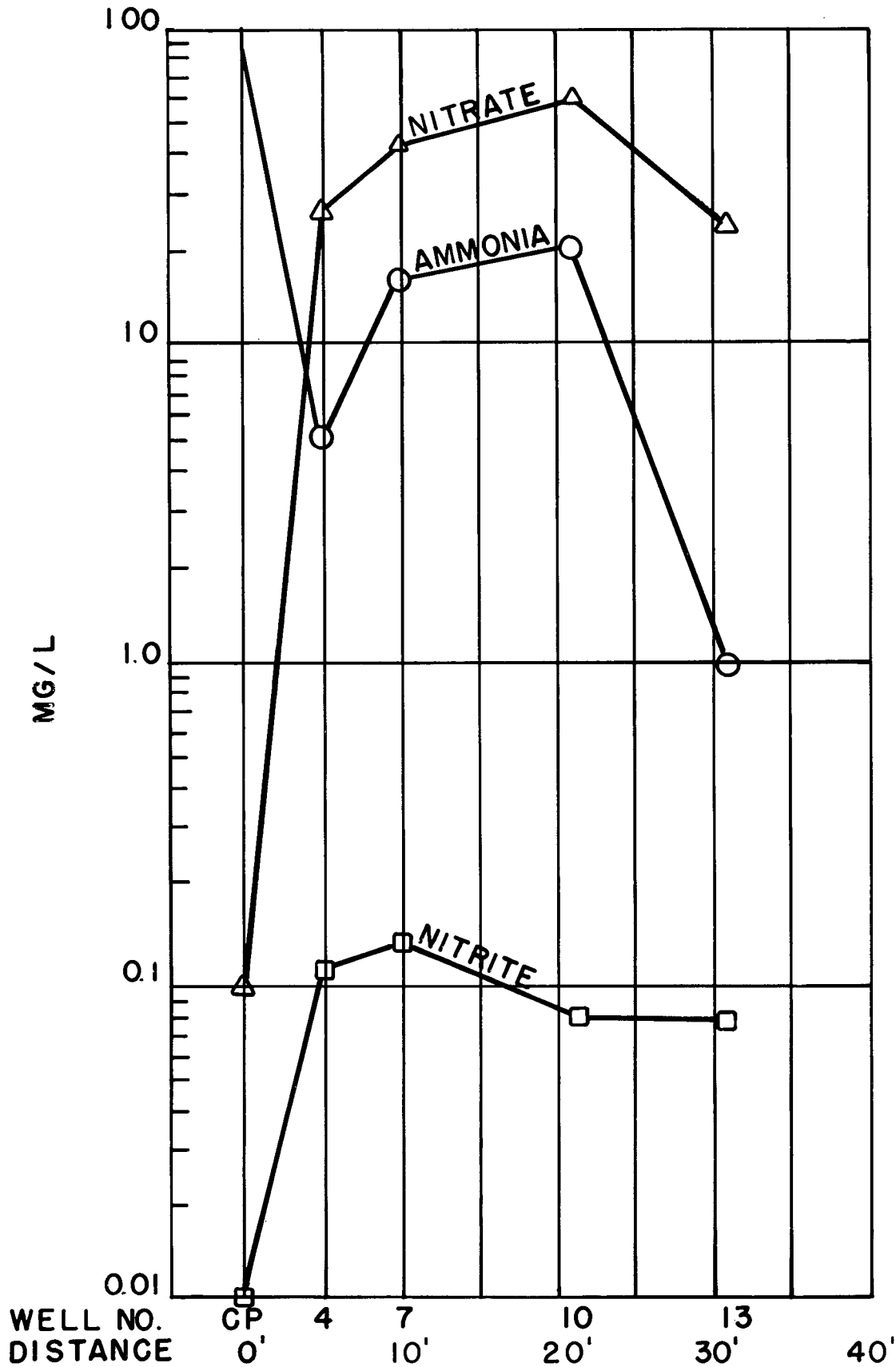

LONG ISLAND GROUND WATER POLLUTION STUDY
 NITROGEN CYCLE VERSUS TRAVEL TIME
 LAS IN USE (3-9-64 / 6-28-65)
 SITE 4 BLUE POINT, SUFFOLK COUNTY

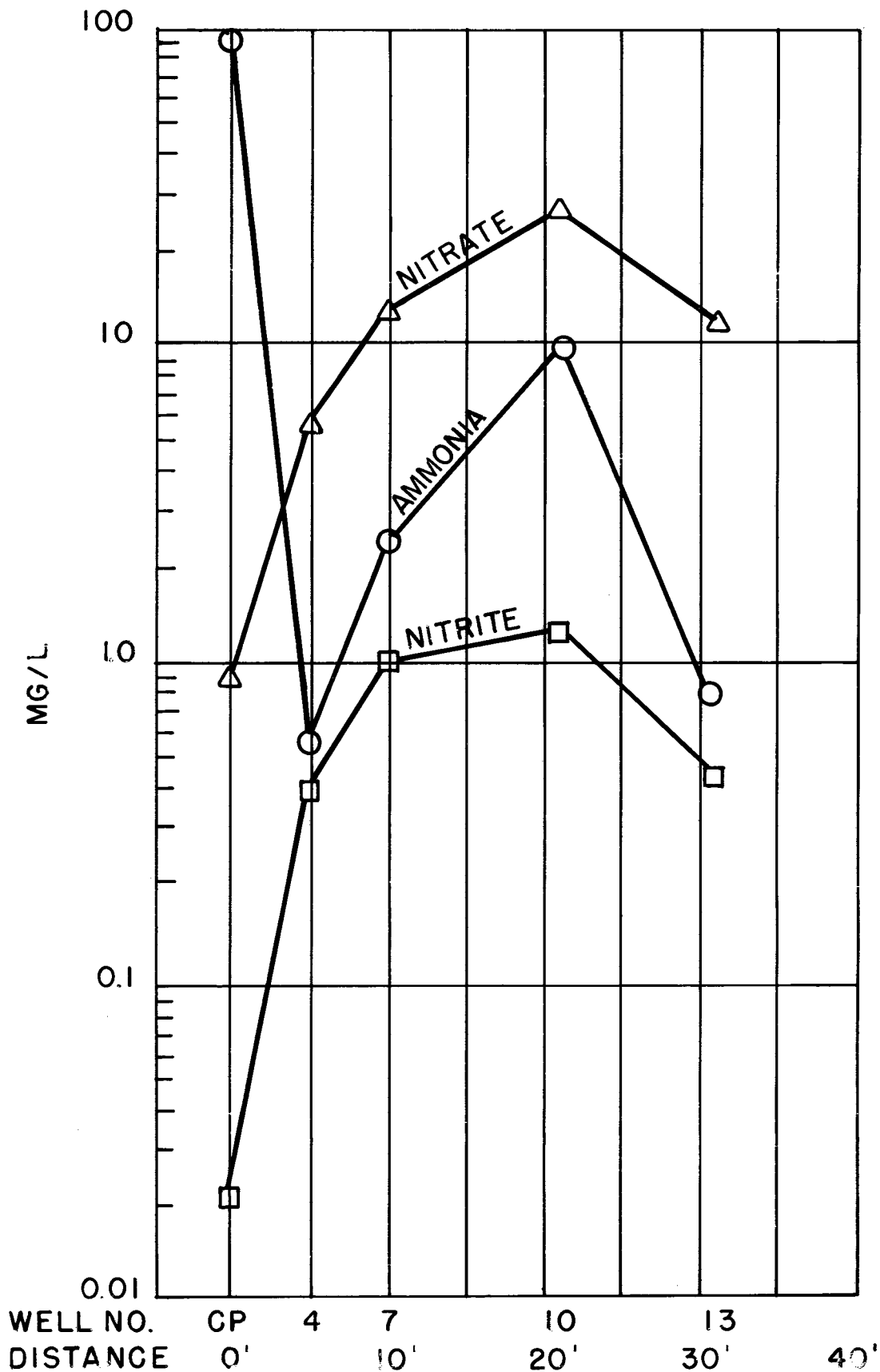

occurred at well group No. 10, 21 feet downstream from the disposal system. Significant nitrates developed at well No. 10 with the use of Soap material, 59.0 mg/l, while nitrates during LAS usage only developed to about half the amount, 25.8 mg/l. (Figure 8-7, 8)

4. Reduction in nitrate concentrations beyond well group No. 10 proceeded at the following rates:

		<u>Average Values</u>	
Soap	48.7%	4.87%/ft.	2.87 mg/l/ft.
LAS	57.4	5.74	1.48

Sulfates

1. Sulfates in the disposal system varied significantly depending upon the washing product in use being 11.8 and 51.2 mg/l during Soap and LAS usage. (Table 8-1) Background observation wells indicated average sulfate levels of between 20 and 30 mg/l.

2. Between the cesspool and first well group, unsaturated soil zone, sulfate concentrations increased during the use of Soap, while a 33 percent reduction occurred with the use of LAS surfactant. (Table 8-2 Figure 8-9)

3. Travel of the waste slug through the downstream saturated soil zone resulted in increasing sulfate levels during the use of both formulations, developing peak concentrations between wells Nos. 7 and 10, 10-21 feet downstream from the cesspool. (Figure 8-9)

4. Between well group No. 10 and final observation well No. 13, sulfates exhibited average reduction rates of:

		<u>Average Values</u>	
Soap		5.25%/ft.	1.98 mg/l/ft.
LAS		2.02	0.83

Compensating for dilution in this saturated zone, using chloride reductions, indicated net sulfate reductions of:

LONG ISLAND GROUND WATER POLLUTION STUDY
REDUCTION VERSUS TRAVEL TIME
SULFATES (12/4/1963-6/28/1965)
SITE N^o 4 - BLUE POINT, SUFFOLK COUNTY, N. Y.

8-19

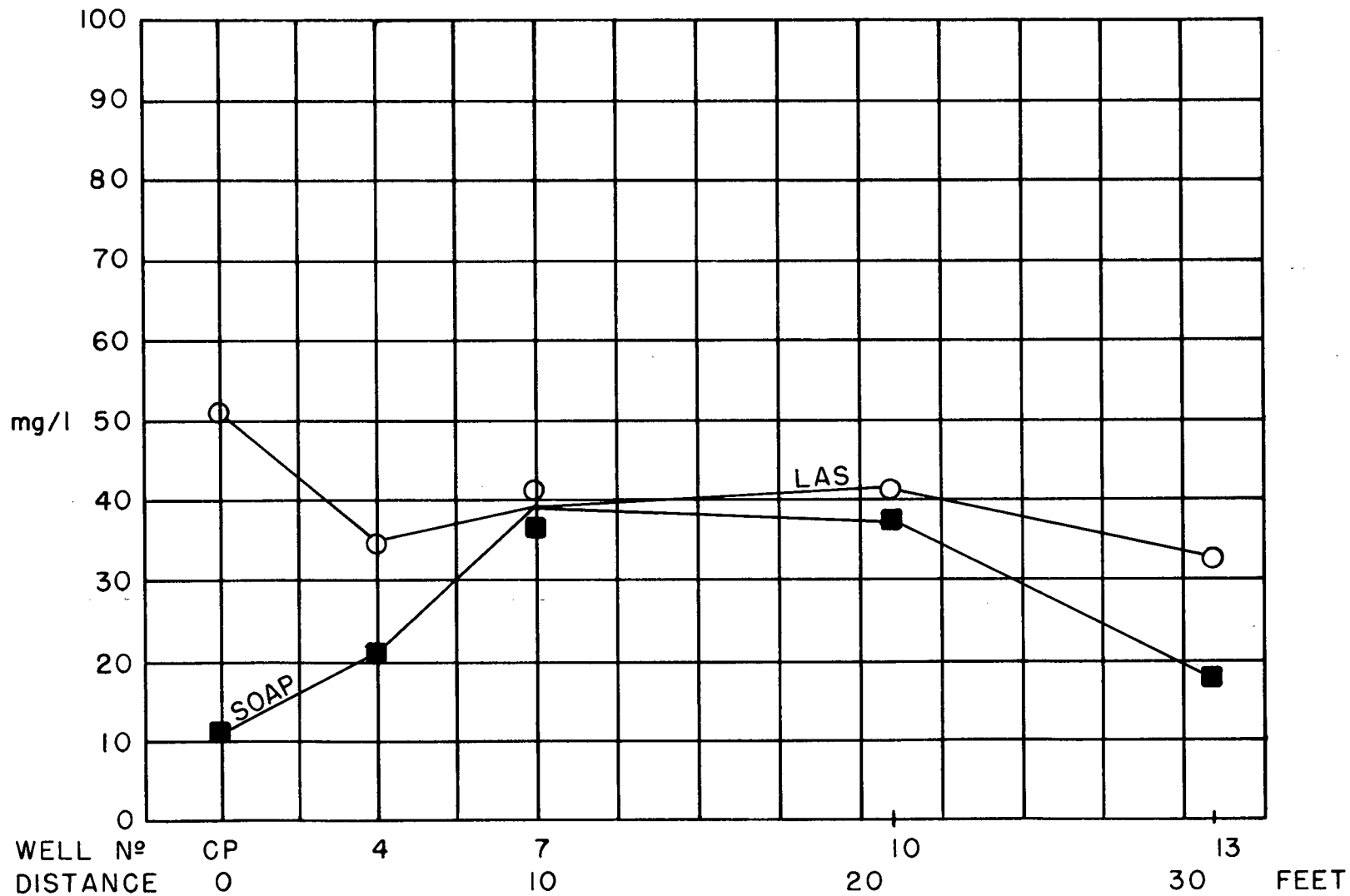

Average Values

Soap	4.12%/ft.
LAS	0.23

Phosphates

1. In most instances, the ortho and total phosphate concentrations in the disposal system and downstream observation wells were about equal. Total phosphate concentrations in the disposal system averaged 56.9 and 81.5 mg/l during the use of Soap and LAS surfactants, respectively. (Table 8-1) Background observation wells indicated total phosphate concentrations of 2.2 mg/l at well No. 1 and 0.06 mg/l in well No. 2.
2. Travel through approximately 12 feet of unsaturated sands (cesspool to first well group) resulted in total phosphate reductions of 92.0 and 99.9 percent during the use of Soap and LAS. (Figure 8-10 Table 8-2)
3. Overall phosphate reduction rates through the entire unsaturated soil zone were:

Average Values

Soap	7.65%/ft.	4.36 mg/l/ft.
LAS	8.25	6.70

4. Upon entering the saturated soil zone, total phosphate levels tended to increase with travel downstream attaining peak amounts at wells No. 7 and No. 10 during the use of Soap and LAS, respectively. (Figure 8-10) Beyond the well group exhibiting peak downstream levels, phosphates reduced in concentration to the final well group at the following rates:

Soap	Well #7-#13	4.75%/ft.	1.20 mg/l/ft.
LAS	10-13	9.80	1.10

Compensating for dilutional effects, based upon reductions in chloride concentration, resulted in net phosphate reduction rates of:

LONG ISLAND GROUND WATER POLLUTION STUDY
REDUCTION VERSUS TRAVEL TIME
TOTAL PHOSPHATES (12/4/1963 - 6/28/1965)
SITE N° 4 - BLUE POINT, SUFFOLK COUNTY, N. Y.

8-21

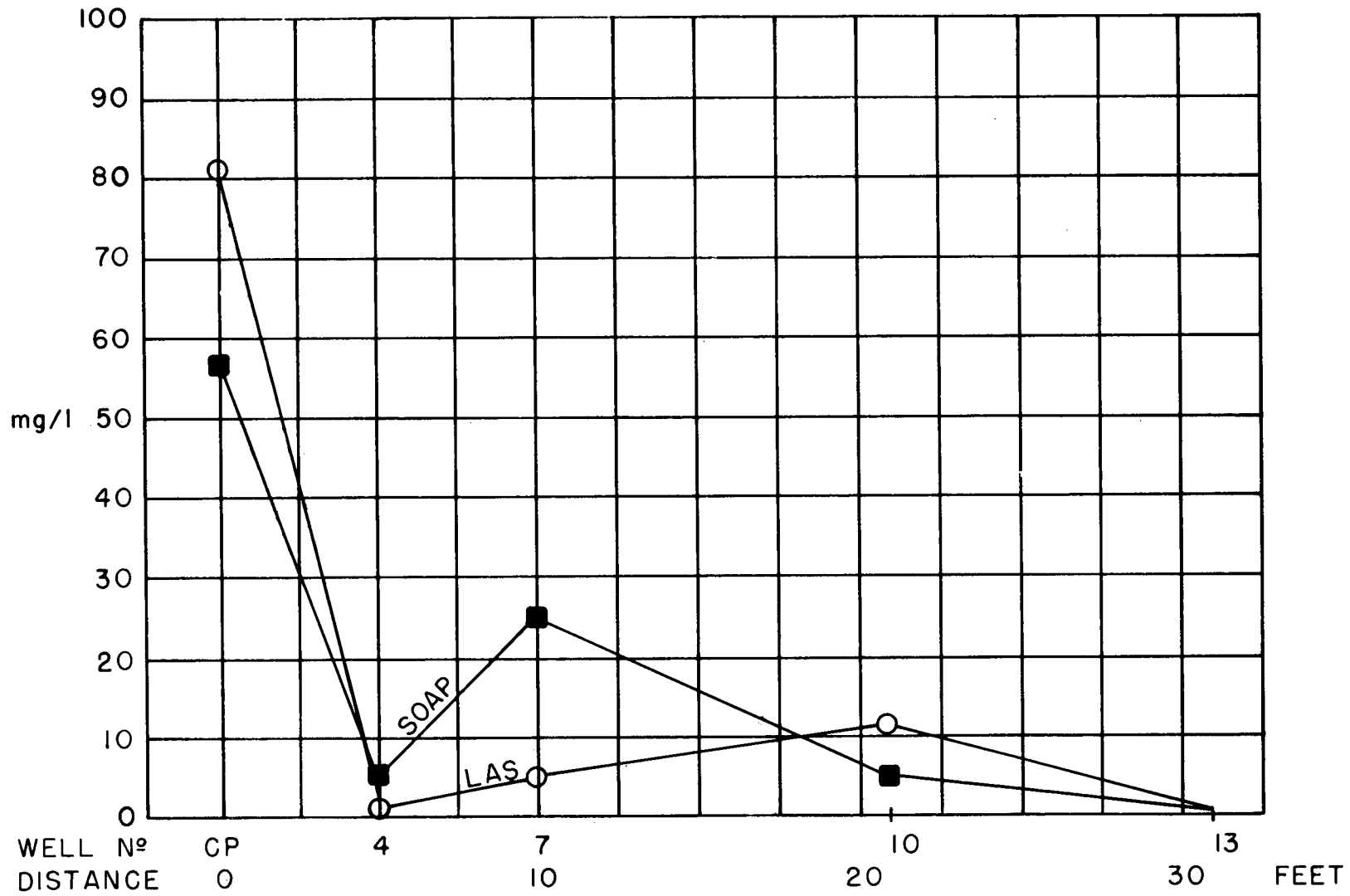

FIG. 8-10

Average Values

Soap 3.62%/ft.

LAS 8.01

5. Factors besides that of dilution aided in reducing total phosphate levels in movement of the sewage slug through the saturated zone.

6. Although changes in total phosphate concentration in the saturated soil zone were erratic, overall reductions of the first well group concentrations of 98.0 and 75.7 percent, resulted during the use of Soap and LAS. (Figure 8-10) Phosphate levels at the final well group No. 13 were 0.09 and 0.17 mg/l, values equivalent to observed background well concentrations. Travel of the waste slug between the cesspool and final well group resulted in total phosphate removals greater than 99.7 percent.

Coliform Organisms

1. Log average coliform concentrations within the disposal system were 6.31×10^6 and 3.51×10^6 per 100 ml during the use of Soap and LAS surfactant, respectively. (Table 8-1) Upstream observation wells indicated log average coliform concentrations ranging between 3.0 and 51.3 per 100 ml.

2. Drastic reductions in log average coliform concentrations greater than 99.9 percent resulted in travel between the cesspool and first downstream well group, (unsaturated soil zone) during the use of Soap and LAS. (Table 8-2 Figure 8-11) Coliform densities at the first well group No. 4 were 76.7 and 464 per 100 ml during the use of Soap and LAS, respectively.

3. Coliform reduction characteristics through the unsaturated zone were not determined.

4. Movement in the saturated soil zone resulted in increasing coliform densities between the first and second well groups followed by a generally decreasing trend out to the final observation well group. An additional 77.3 and 66.0 percent reduction was observed through the downstream flow path. (Table 8-2)

5. There was a definite relationship between coliform concentrations and reductions

LONG ISLAND GROUND WATER POLLUTION STUDY
 REDUCTION VERSUS TRAVEL TIME
 LOG AVERAGE COLIFORM (12/4/1963 - 6/28/1965)
 SITE N° 4 - BLUE POINT, SUFFOLK COUNTY, N.Y.

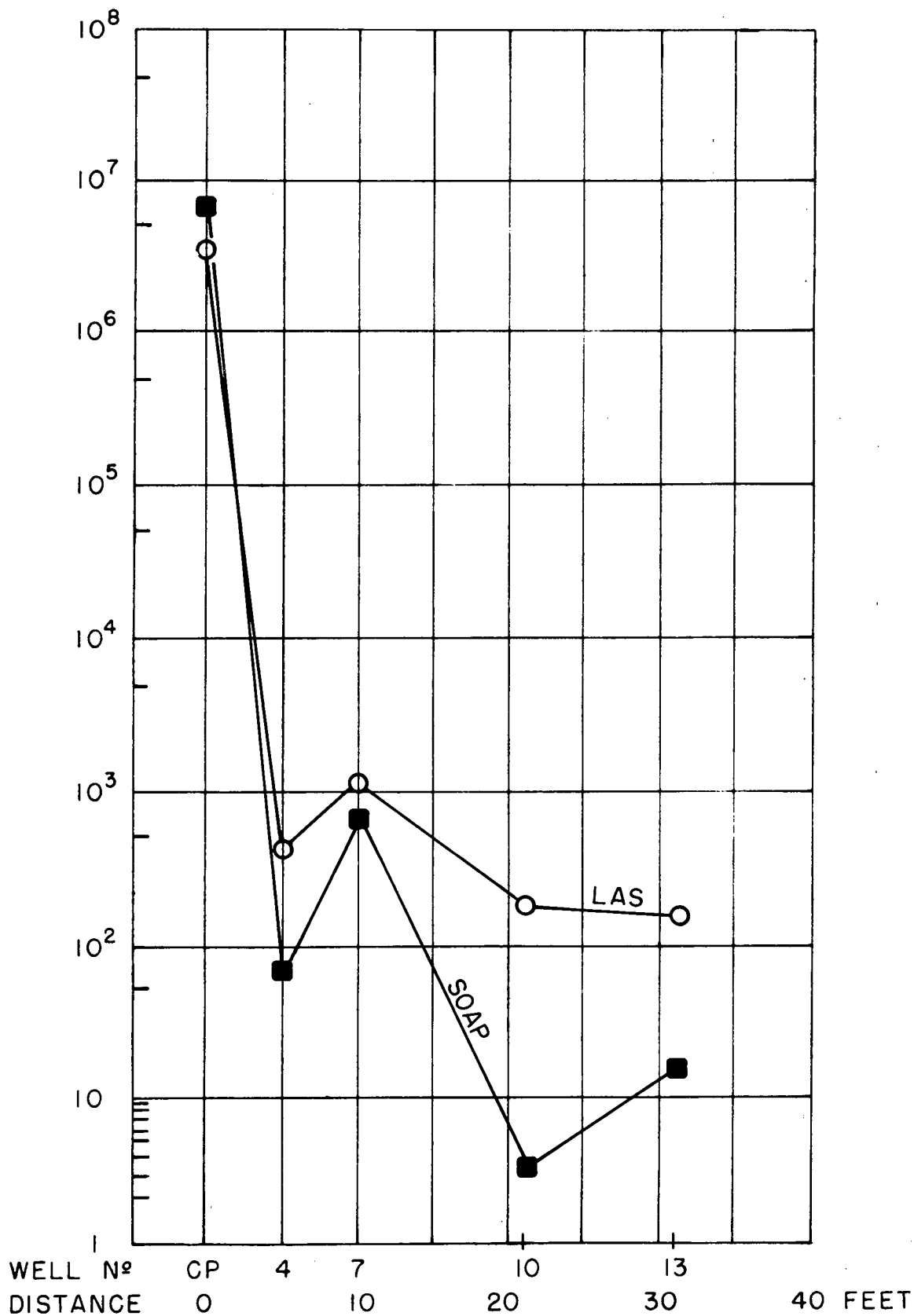

in MBAS, phosphates and other constituents in travel through the unsaturated and saturated soil zones. In the unsaturated zone, where large bacterial reductions occurred similarly significant, reductions occurred in other sewage constituents. In the saturated zone, persistence of coliform was concurrent with small reductions in other sewage contaminants.

6. Coliform concentrations at the last observation well group 31 feet downstream from the cesspool were such that the log average concentration exceeded bacterial standard set for water supplies. (Table 8-1 Figure 8-11)

Alkalinity

1. Alkalinity content in the disposal system during the use of Soap and LAS surfactants averaged 549.3 and 440.0 mg/l as CaCO₃, respectively. (Table 8-1) Background observation wells exhibited uniform alkalinity levels through the sampling depth, averaging 13.0 mg/l as CaCO₃. (Table 4-1)

2. Travel of the sewage slug through the unsaturated soil zone, cesspool to first well group, resulted in extremely large reductions of alkalinity, averaging 97.0 and 95.0 percent during Soap and LAS usage, respectively. (Table 8-2 Figure 8-12)

Changes in alkalinity level at various stages of the unsaturated soil zone was not determined on this site.

3. Alkalinity concentrations at the first downstream well group, 18.1 and 20.6 mg/l as CaCO₃, were approximately equal to background well alkalinity levels which averaged 13.9 mg/l as CaCO₃. (Table 8-1 Table 4-1)

4. In movement through the downstream saturated soil zone, alkalinity levels during the use of Soap and LAS increased slightly to well group No. 10, 21 feet downgradient from the cesspool. Subsequent travel in the saturated soils resulted in a uniform decrease in alkalinity concentrations to the final well group No. 13. (Figure 8-12)

At the final well group, alkalinity levels were about equal to those observed in the background ground waters.

5. Between downstream well groups No. 10 and No. 13, 10 feet travel distance,

LONG ISLAND GROUND WATER POLLUTION STUDY
REDUCTION VERSUS TRAVEL TIME
ALKALINITY (12/4/1963 - 6/28/1965)
SITE N° 4 - BLUE POINT, SUFFOLK COUNTY, N.Y.

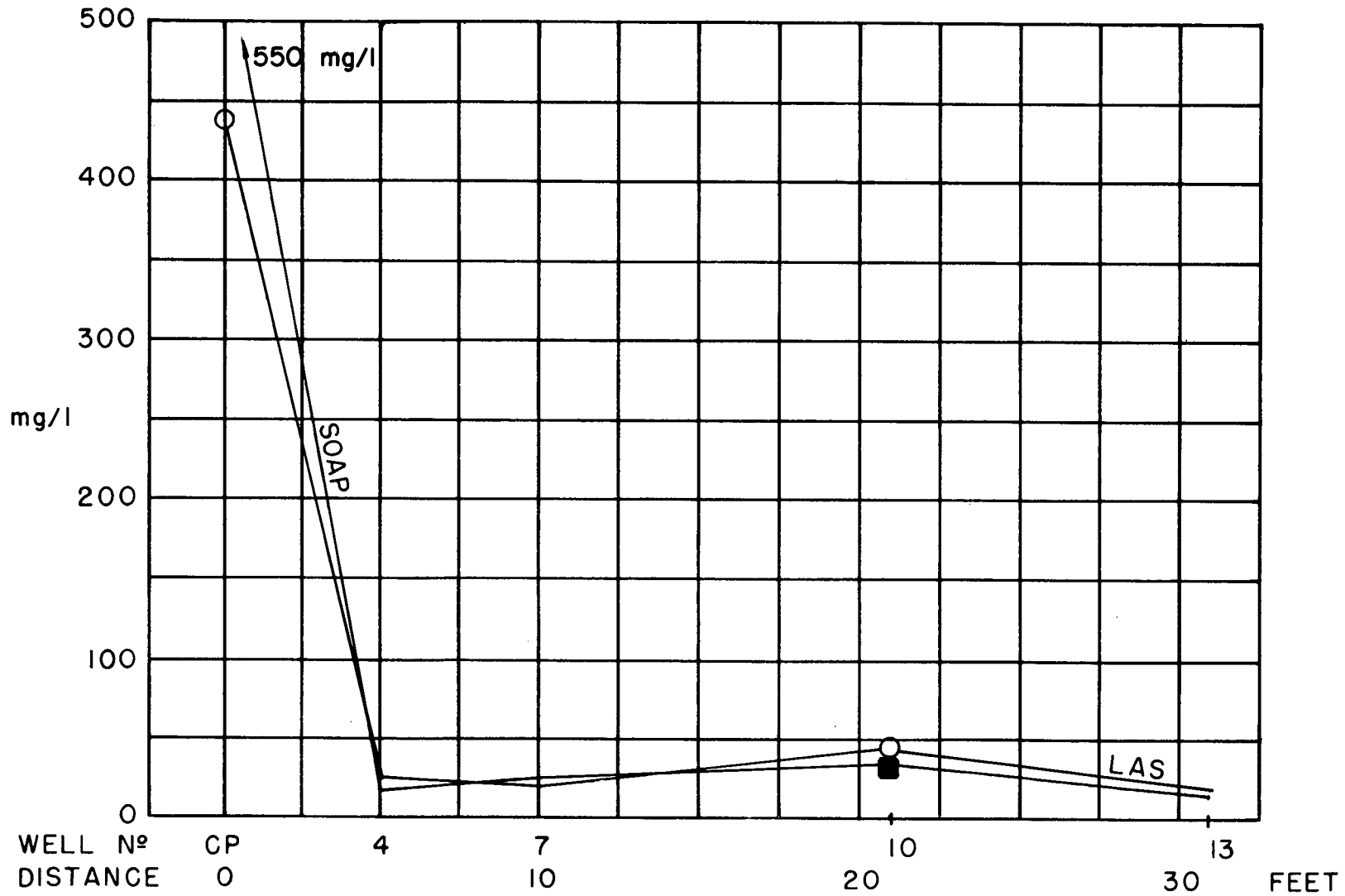

8-25

alkalinity levels reduced at the following rates:

	<u>Average Values</u>	
Soap	5.65%/ft.	1.77 mg/l/ft.
LAS	5.92	2.42

Adjusting for dilutional effects in the downstream flow path, based upon chloride reductions, indicated net alkalinity reduction rates of:

	<u>Average Values</u>	
Soap	4.52%/ft.	
LAS	4.13	

6. Apparently, factors besides that of dilution were effective in reducing alkalinity concentrations through portions of the saturated zone flow path, Wells No. 10 to No. 13.

Specific Conductance

1. Specific conductivity in the disposal system averaged 914 and 953 $\mu\text{hos}/\text{cm}^2$ during the use of Soap and LAS surfactant, respectively. (Table 8-1) Background observation wells indicated average specific conductivity measurements of 113 to 152.3 $\mu\text{hos}/\text{cm}^2$ in the upstream ground waters.

2. Significant reductions in specific conductance, 68.3 and 84.7 percent, occurred during the use of Soap and LAS in travel through the unsaturated soil zone, cesspool to first well group. (Table 8-2)

3. Characteristic during the use of Soap and LAS surfactant, specific conductance increased at a relatively uniform rate in the initial portion of the saturated soil zone, Wells No. 4 to No. 10, a travel distance of 21 feet from the cesspool. Beyond well group No. 10, specific conductivity decreased at a rapid rate out to the final observation well group during the use of both formulations. (Figure 8-13)

4. Specific conductance reduction rates in the saturated soil zone, Wells No. 10 to No. 13 (10 feet travel distance) were:

	<u>Average Values</u>	
Soap	6.28%/ft.	36.7 $\mu\text{hos}/\text{cm}^2/\text{ft.}$
LAS	4.53	15.5

LONG ISLAND GROUND WATER POLLUTION STUDY
REDUCTION VERSUS TRAVEL TIME
SPECIFIC CONDUCTANCE (12/4/1963-6/28/1965)
SITE N° 4 - BLUE POINT, SUFFOLK COUNTY, N. Y.

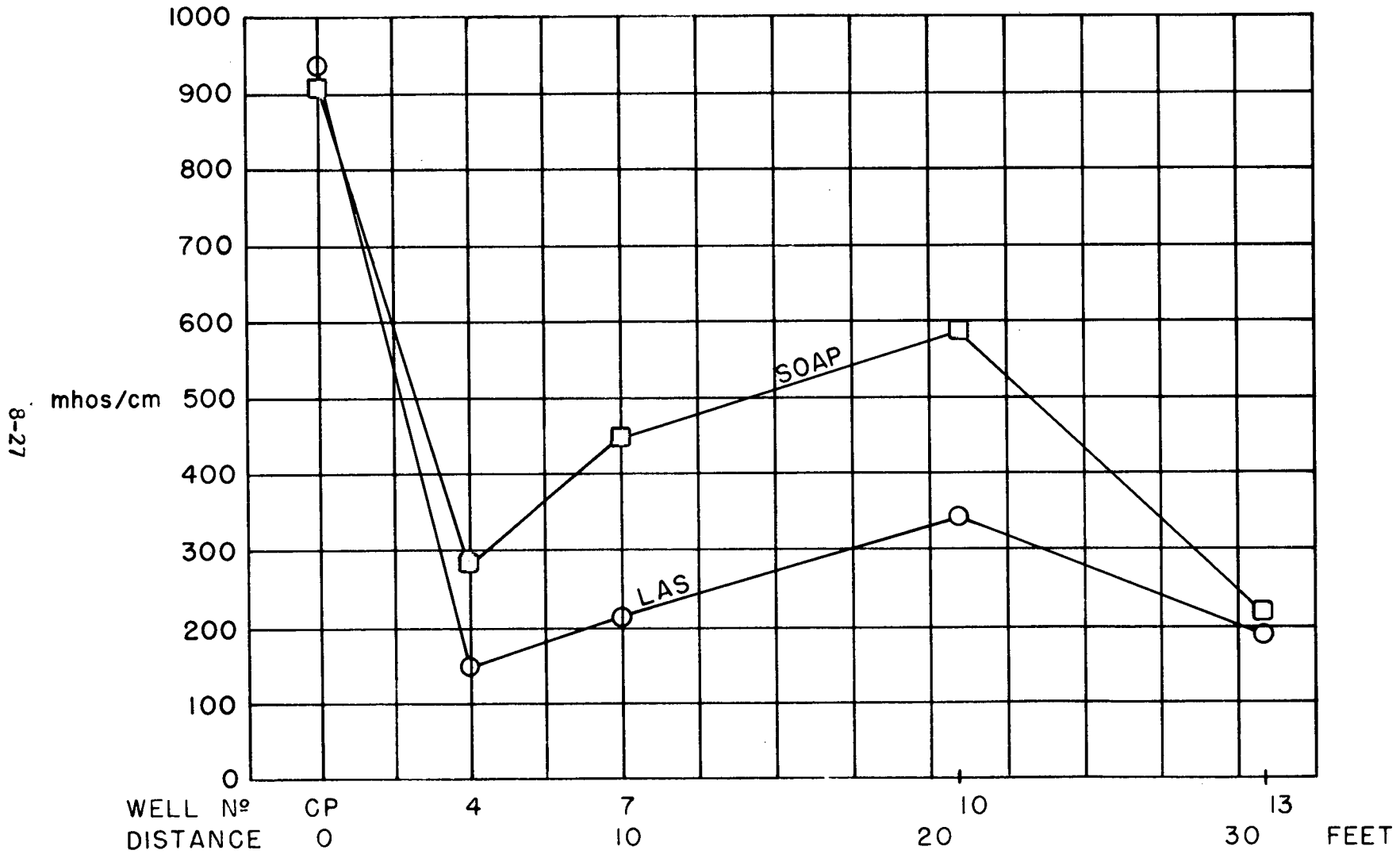

Chloride reductions in the saturated zone, dilution had rates significantly less than those observed for specific conductivity.

COD

1. Chemical oxygen demand, COD, in the cesspool during the use of Soap averaged 207 mg/l. (Table 8-1) Upstream observation wells exhibited COD concentrations in the background ground waters, averaging 7.9 to 11.6 mg/l.

2. Travel from the cesspool to first downstream well group, unsaturated soil zone, resulted in a 91.3 percent reduction in COD during the use of Soap. (Figure 8-14) COD reduction characteristics throughout the unsaturated zone were not determined.

3. Between the first and second downstream well groups, COD levels tend to increase. (Figure 8-13) Further travel in the saturated soil zone resulted in decreasing COD concentrations out to the final wells and having the following reduction rate:

Average Value

Soap 2.55%/ft. 1.0 mg/l/ft.

Adjusting for dilutional effects, based upon chloride reductions, resulted in a net COD reduction of:

Average Value

Soap 1.42%/ft.

4. Factors besides that of dilution were effective in the removal of COD in the saturated soil zone during the use of Soap.

BOD

1. Biochemical oxygen demand in the cesspool varied with each surfactant, averaging 549 and 346 mg/l during the use of Soap and LAS surfactant, respectively.

2. BOD/COD ratio in the cesspool during the use of Soap was 2.65, indicating possible laboratory error in the determinations. For domestic sewage a BOD/COD ratio greater than 1.0 should not exist.

LONG ISLAND GROUND WATER POLLUTION STUDY
REDUCTION VERSUS TRAVEL TIME
COD (12/4/1963-3/9/1964)
SITE N^o 4 - BLUE POINT, SUFFOLK COUNTY, N.Y.

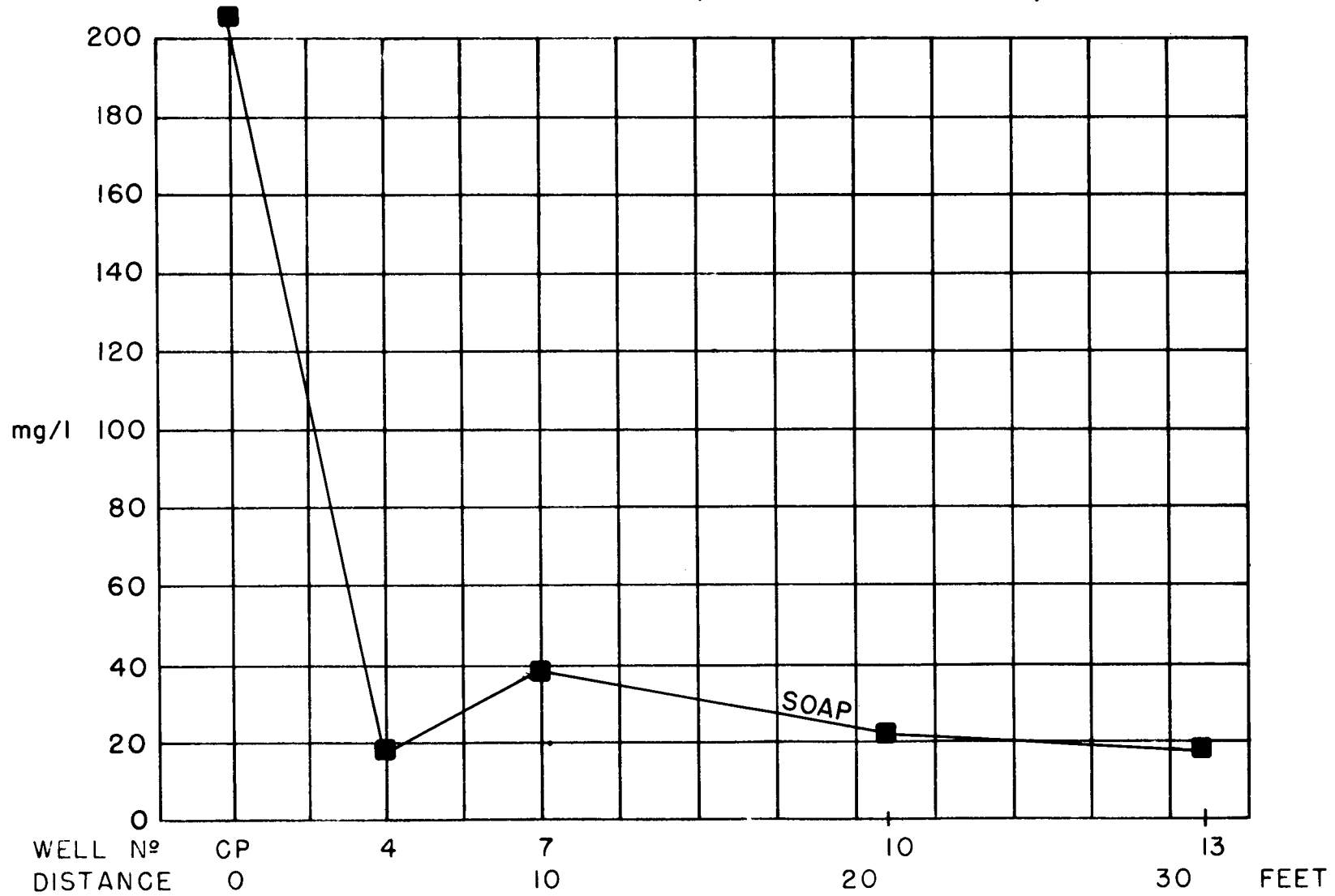

8-29

	<u>BOD</u>	<u>COD</u>	<u>BOD/COD</u>
Soap	549 mg/l	207 mg/l	2.65
LAS	346	---	---

3. BOD concentrations in the cesspool were significantly greater than that of the suspended solids. There was no exact ratio between BOD and suspended solids in the disposal system.

Total and Suspended Solids

1. Total and suspended solids in the disposal system were relatively constant during the use of Soap and LAS surfactant.

	<u>Total Solids</u>	<u>Suspended Solids</u>	<u>BOD</u>
Soap	625	169	549
LAS	620	134	346

2. Although solids levels remained relatively constant, considerable difference in the amount of BOD present during the use of Soap and LAS resulted. Generally, the larger BOD level occurred with the use of Soap along with slightly larger total and suspended solids concentrations.

LONG ISLAND GROUND WATER POLLUTION STUDY
 REDUCTION VERSUS TRAVEL TIME
 SOAP IN USE (12/4/1963-3/9/1964)
 SITE N^o 4 - BLUE POINT, SUFFOLK COUNTY, N. Y.

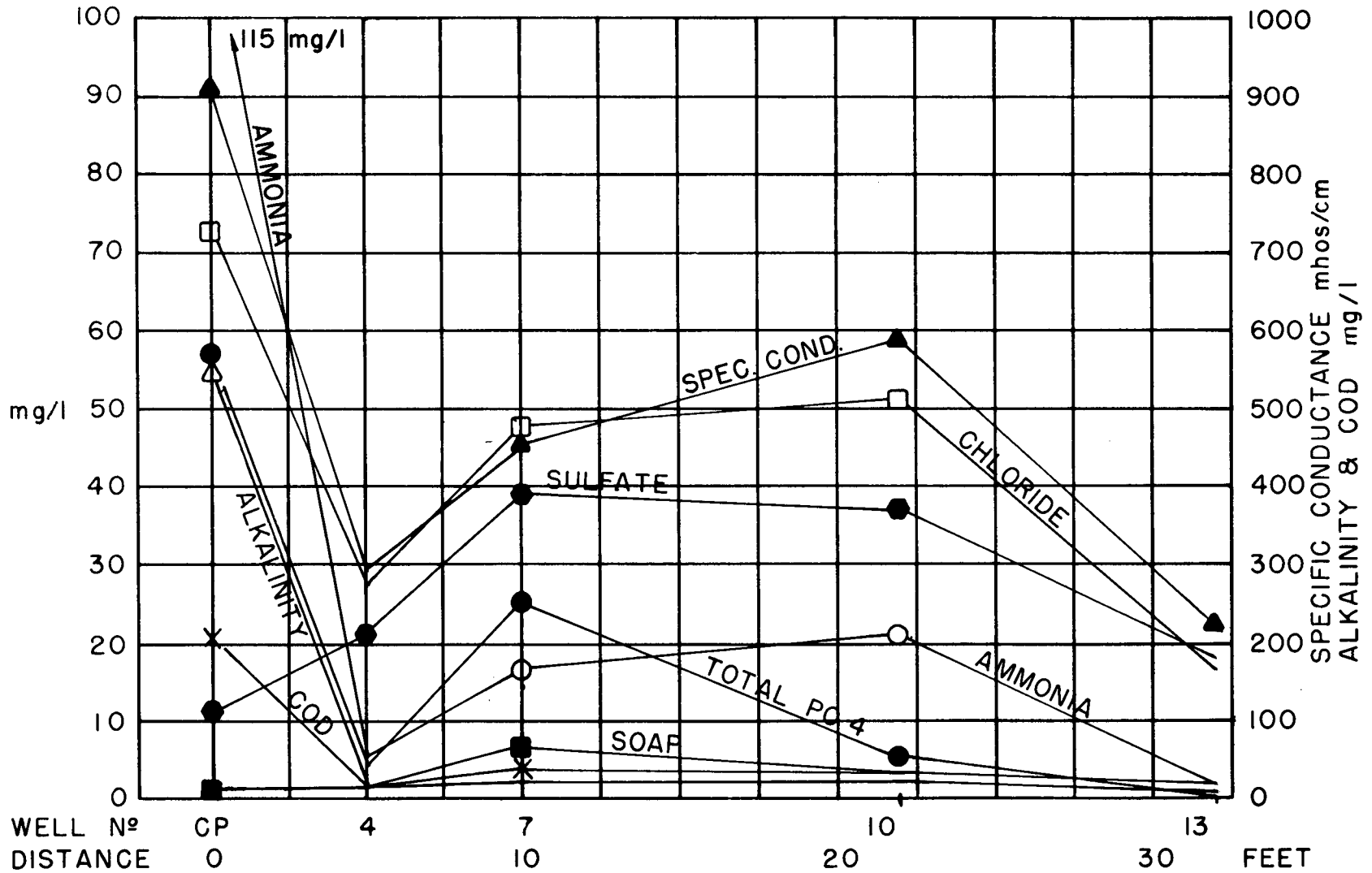

8-31

LONG ISLAND GROUND WATER POLLUTION STUDY
 REDUCTION VERSUS TRAVEL TIME
 LAS IN USE (3/9/1964-6/28/1965)
 SITE N° 4 - BLUE POINT, SUFFOLK COUNTY, N.Y.

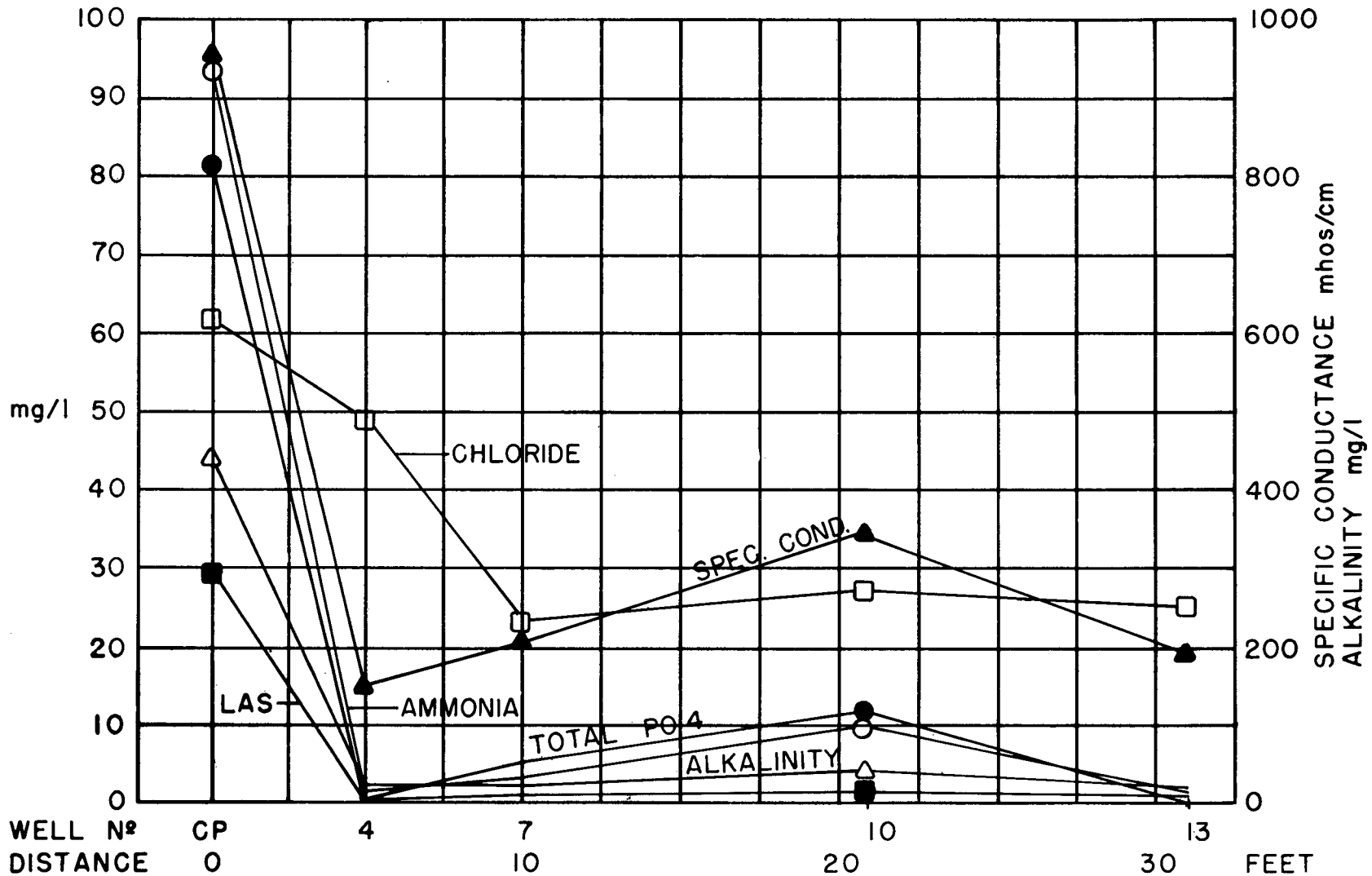

8-32

FIG. 8-16

PART 9 - SITES 5 and 6

Introduction

Sites 5 and 6 were selected to reflect conditions associated with a septic tank-tile field type of domestic sewage disposal system as contrasted to the sites initiated earlier, all of which involved a perforated wall type of leaching facility. A survey to locate appropriate sites was not successful in obtaining locations with available property down-gradient to enable the monitoring of the waste plume in the saturated soil zone. It was then decided to proceed with the development of Site 5 with primary intention to study the change in character of the sewage in passage from the disposal system through the unsaturated soil. Later, Site 6 was located with the desirable orientation of the system with respect to the ground water gradient. It was decided not to proceed with monitoring of the waste plume downstream because of the limitation in available funds for test wells and the heavy commitments of the available laboratory facilities at the time.

Description

Site 5

Site 5 was located in Massapequa, Nassau County, on the south shore of Long Island and in the extreme south-easterly portion of Nassau County on the Nassau Shores peninsula. The site is approximately one mile north of South Oyster Bay, 1/10 mile west of the Carman River and 1/2 mile east of the Unqua River. The plot size is 120 ft. in frontage, facing easterly and 100 ft. in depth. The ground is flat and amply provided with deciduous trees and evergreen shrubs. The area is typical residential consisting of moderate sized ranch type homes. The nearest disposal system is a cesspool system to the north serving the neighboring residence.

The family consists of two adults and four children who normally occupy the home except for annual vacations. Water use appliances other than basic kitchen and bath facilities consist of an automatic laundry machine and dishwasher. The house has been occupied by the family since constructed in January, 1955.

The sewage disposal system, (Figure 9-1) located in the front lawn, consists of a conventional concrete septic tank of 600 gallons capacity, a concrete distribution box and three tile trenches of average length of 22 ft. 6 in. located parallel to the building front, 6 ft. on centers and sloping to the south. The tile pipe in the trenches is from 2 ft. 7 in. to 3 ft. 8 in. below grade.

The home was originally provided with a private well 30 ft. deep for water supply but the residence was connected to a public water main in the street in 1963. The original well was reported by the owner to have produced a foamy, rusty water with a hydrogen sulfide odor. The public water supply serving the residence is the New York Water Service Division (Merrick Plant) of Utilities and Industries, Inc.; the source for the Nassau Shores area is primarily a well located approximately two miles north of the site.

The static water table is located approximately 8 ft. below grade at elevation of 3 ft.; grade is at approximately 11 ft. Elevations are referred to mean sea level (Nassau County Datum).

The subsoil at the site is the typical fine to medium sand representing the glacial outwash plain which forms the southerly shore of Long Island.

Site 6

Site 6 was located on Henry Street in the Bellmore area, in the southeasterly portion of Nassau County. The site is approximately two miles north of East Bay, 1/2 mile west of the Wantagh State Parkway and 1/2 mile north of Sunrise Highway. A small creek running due south is located in the rear of the property. The plot size is 100 ft. in frontage, facing west and 150 ft. in depth. The ground is flat and covered with virgin deciduous trees. The area is typical

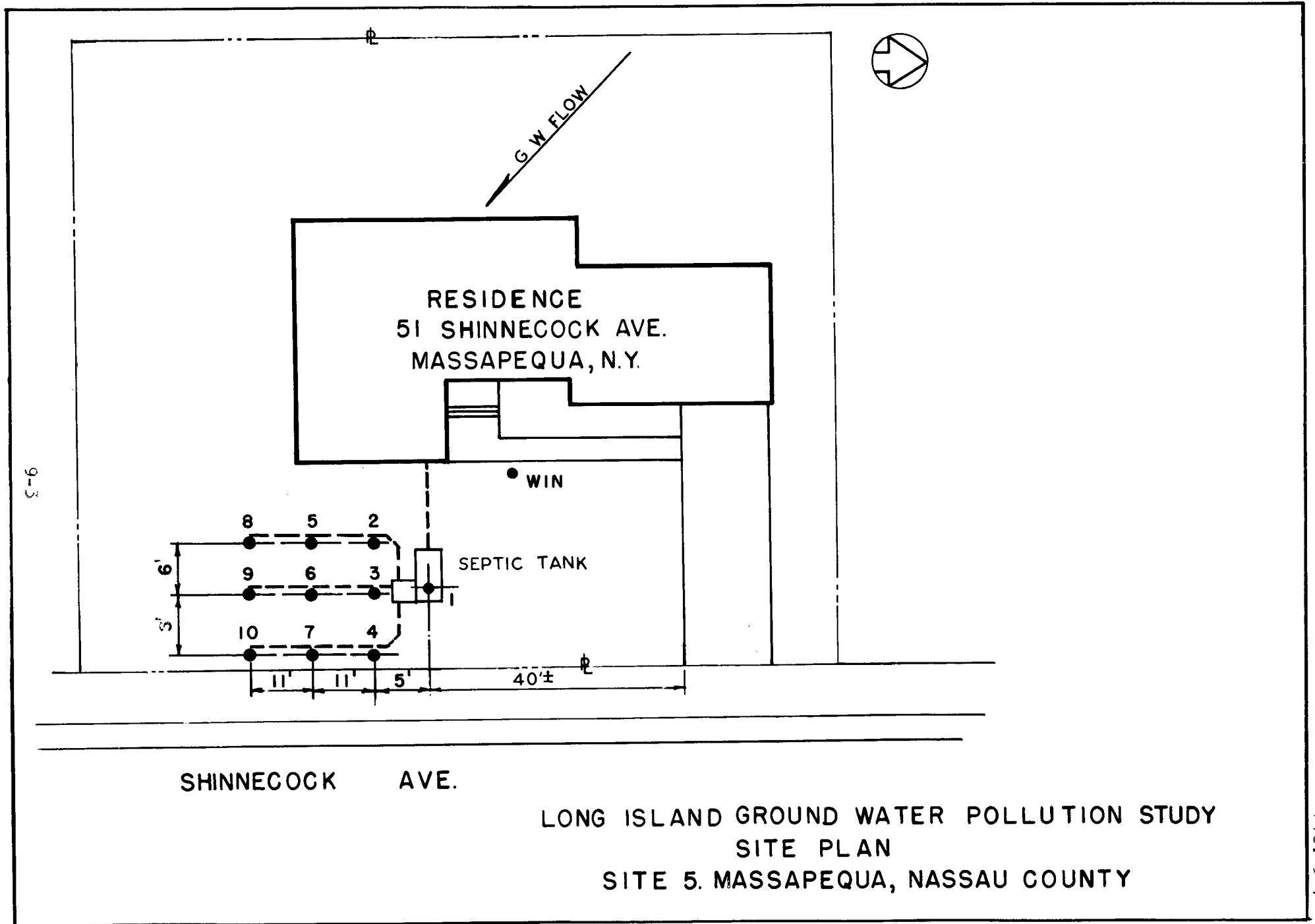

LONG ISLAND GROUND WATER POLLUTION STUDY
 SITE PLAN
 SITE 5. MASSAPEQUA, NASSAU COUNTY

residential and the locality of the site has been recently developed. The home was constructed just prior to selection as a test site and occupied in February, 1964. The nearest disposal system is immediately to the north serving the neighboring residence.

The family consists of two adults and four children who normally occupy the home. Water use appliances, other than basic kitchen and bath facilities, consist of an automatic laundry machine and dishwasher.

The sewage disposal system, (Figure 9-2) located in the front lawn, consists of a 600 gallons concrete septic tank, a distribution box and four, 4 in. diameter tile lines, three of which are 25 ft. in length, and the fourth, 50 ft. in length. The tile lines generally parallel the front of the dwelling, are 6 ft. on centers and slope to the south. They rest on one bed of gravel extending throughout the tile field. The inverts of the tile pipe are approximately 1 ft. 9 in. above ground water and 2 ft. 9 in. below the ground surface.

The residence was originally provided with a private well for water supply. The well was reportedly installed in February, 1964, at an original depth of 28 ft. and was subsequently deepened to 34 ft. below grade. During the test period (December, 1964) public water mains were extended to provide water service to the street. The area is served by the Merrick Plant of New York Water Service, Division of Utilities and Industries, Inc. Public wells serving this area are located at three sites, two of which are located approximately two miles distant to the east and northwest, and another, three miles to the west.

The static water level is located approximately 4 ft. 6 in. below the ground surface. Elevation of static water surface was established during site development as approximately 17 ft. above mean sea level.

The subsoil at the site is primarily coarse and medium coarse brown sand, grit and gravel from a depth of 6 ft. to at least 25 ft. The overburden is sandy

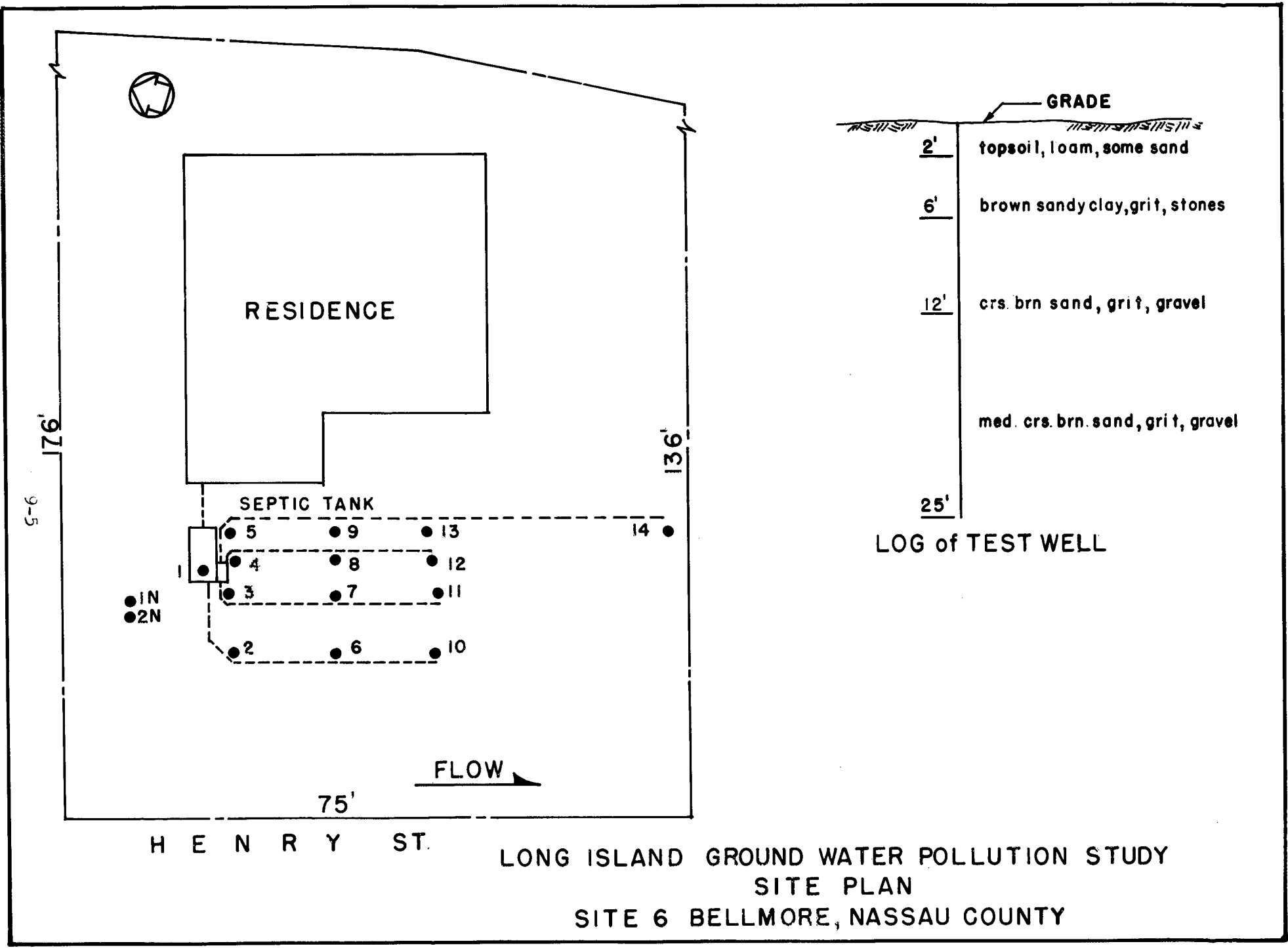

clay, grit and stones over-laid with 2 ft. of topsoil loam and some sand. A boring log is shown in Figure 9-2.

Waste Plume Location

Site 5

The orientation of the downstream waste plume in the saturated soil zone was predicted prior to development of the site as generally southerly. The site was anticipated to provide information on the waste plume in the saturated soil zone from a single tile line. The site development was initiated on January 28, 1964, and included installation of probe wells at the corners of the site and at the center of the southern boundary. Static water levels were read and used to establish the direction of the ground water gradient. The direction was established at S 23° E and represented a divergence of 36° from the axis of the tile trenches. No further attempt was made to study the waste plume in the saturated soil at the site because of the inability to segregate the effect of an individual line. The extensive lateral dimension of the waste plume emanating from a source more than 22 ft. in width was expected to provide small variation and low levels in constituents studied, and therefore, the additional effort was not justified.

A probe well (10A) was installed at the furthest extremity of the easterly tile line to determine the vertical location of the waste plume. Samples were collected at 1 ft. intervals below the static water level. Results of MBAS analyses of these samples is shown in Table 9-1. The high values at the top of the water table and gradual reduction over a depth of 7 ft. appear to represent the influence of the on-site disposal system. The high values from 8 ft. to a depth of 13 below static water appear to represent upland influences.

The site development was temporarily suspended while additional surveys were made to locate sites more amenable in orientation of system with respect to

Table 9-1

MBAS IN GROUND WATER (WELL 10A) - SITE 5

(April 24, 1964)

<u>Depth (ft.) Below Grade</u>	<u>Depth (ft.) Below SWL</u>	<u>MBAS (mg/l)</u>
9	1	9.0
10	2	9.5
11	3	5.0
12	4	1.5
13	5	1.5
14	6	1.25
15	7	1.4
16	8	1.6
17	9	5.0
18	10	3.5
19	11	3.5
20	12	3.5
21	13	3.5
22	14	3.5

direction of ground water gradient. Decision was reached in April, 1964, to proceed with development of the Massapequa site.

Site 6

The orientation of the waste plume downstream from the system was predicted before site development to be generally parallel to the tile lines. The site development included installation of probe wells at the four corners of the site. Static water level readings confirmed the predicted direction of the ground water gradient as approximately S 30° E.

Three probe wells were installed adjacent to one of the intermediate tile lines to determine the concentration of MBAS with respect to depth in the ground water. Water samples were collected at one foot intervals. Results of MBAS analyses of these samples are shown in Table 9-2. The higher concentrations and deeper penetration of MBAS in vicinity of the upper end of the disposal system are attributable to the newness of the system and the more permeable soil present in that vicinity. The presence of a clay type soil directly below the middle portion of the tile lines would minimize downward percolation of wastes in that area and cause a lower concentration of sewage constituents there. The higher concentration of MBAS at a lower elevation in the ground water appears to be influenced by a source remote from the test site.

Test Well Installation

Site 5

A portion of the site development was initiated in January, 1964, including location, inspection of condition and determination of actual dimensions of the several components of the disposal system. The septic tank was pumped out on January 29, and found to have an earth bottom. Tile lines were located and test wells installed at ends and the mid-points of the three lines. An additional well was constructed for sampling of the septic tank liquid. Wells in tile field were placed 9 inches to the east of the centerline of the tile pipes.

Table 9-2

MBAS IN GROUND WATER - SITE 6 - May 1964

<u>Depth (ft.) Below Grade</u>	<u>Depth (ft.) In Ground Water</u>	<u>MBAS* (mg/l)</u>		
		<u>Probe 3-A</u>	<u>Probe 7-A</u>	<u>Probe 11-A</u>
5	1	-	-	-
6	2	5.0	20.0	4.5
7	3	3.0	16.0	3.5
8	4	1.5	1.0	3.5
9	5	0.5	1.0	3.0
10	6	0.0	0.5	2.5
11	7	0.0	0.0	0.0
12 - 20	8 - 16			0.0
21	17			0.5
22	18			0.5
23	19			0.5
24	20			0.5
25	21			0.4
26	22			0.4
27	23			0.4

*Field Determination

Test wells were provided with 6 in. screens except for the septic tank well which had a 12 in. long screen.

On April 24, 1964, the remaining development work on Site 5 was initiated. The septic tank was emptied and the earth bottom sealed with a 4 in. layer of synthetic gel to insure that samples collected from the ground water beneath the tile field were not influenced by any leaching directly from the septic tank.

Preliminary samples were collected from the ten original test wells on April 5, and analyzed for MBAS. The results were consistent except for the wells at the mid-point and far end of westerly tile trench in which MBAS levels were found to be in order of 1/10 of the values from the other test wells. An investigation of clogging of tile lines was made on April 24, 1964, involving use of inflatable rubber bladders to seal off the three outlets from the distribution boxes. The distribution box was filled with water, one outlet opened quickly and the time required to drain the box observed. The operation was repeated for other two outlets. The results confirmed the suspicion that the westerly tile line was partially clogged. The lack of reliability of samples obtained from test wells 5 and 8 caused data from these wells to be disregarded in the several evaluations which are discussed later in this report.

During the site development work, a check was made of the submergence of each of the nine test wells into the ground water. Well depths were adjusted to provide a uniform penetration of the screen bottom to 12 in. below the static water level.

Site 6

The site development was initiated on April 24, 1964. Tile lines were located and test wells with 6 in. screens were driven at both ends and center point of the three shorter tile lines and at four points of the longer line.

Wells were driven 9 in. west of the tile lines and to a depth of 12 in. below static water. The earthen bottom of the distribution box was sealed with synthetic gel. A test well with 12 in. screen was installed in the septic tank for sampling the contents.

Sampling of the test wells began on May 19, 1964. Difficulty was experienced in collecting samples from several test wells initially due to both the presence of impervious soil pockets at the static water level of some wells and also to the lack of sufficient penetration of the well screens below the static water at several points. Several wells were subsequently deepened but impervious soil at Wells 3 and 7 prevented adequate sampling of these wells throughout the study period. Initial values for sewage constituents from several test wells were not generally uniform but after adjustment of well screens, more consistent values were obtained, except for Well 14, for which levels of sewage constituents were appreciably lower than for the other wells. This was due, in all probability, to the lack of effluent reaching this remote point in the relatively new system. Data from this well was, therefore, not included in the data summaries for this site.

Sample Collection

Samples from Sites 5 and 6 were collected from the test wells at one week intervals starting on May 19, 1964 until October 6, 1964, whereupon a two week interval was established between sample runs. Site 5 sampling was terminated on September 20, 1965; Site 6 was terminated on April 27, 1965.

Water Use

Water consumption on Site 5 was determined on the basis of a residential water meter already in use at the initiation of the site study. Based on the records of the water company and direct readings during the study, an average daily water consumption of 306 gallons was established for a twelve month period.

This included water used for lawn sprinkling and other exterior uses which water was not discharged to the sewage disposal system.

Water used on Site 6 was determined initially by installation of a meter as part of the study. A four month average daily consumption rate from August to September, 1964, was determined to be 151 gallons which did not include water used from outside hose bibs. The average daily consumption for a shorter period - September, 1964 - was approximately 200 gallons.

Product Use

Test products used in Sites 5 and 6 were LAS followed by AS and Soap. ABS was used on Site 5 for the final five months of the study after Site 6 was closed. A summary of test products used and water consumption is shown in Table 4-3.

Results of Analysis

The analysis of samples from the several test wells at each site represent levels of sewage constituents at three basic locations - the ground water background, septic tank supernatant and the upmost portion of the ground water beneath the tile field. This data can therefore be compiled to demonstrate the change of concentration of each of the studied sewage constituents during passage of the waste through the disposal system. Moreover, these comparisons are available separately for each of the four detergent test products used at these sites.

Data for Sites 5 and 6 for the four test products are summarized in Table 9-3 to 9-10.

Overall analysis of data indicates a significant and consistent difference in constituents levels for the two sites. Site 5 generally exhibited significantly lower levels of MBAS, chlorides, nitrogen constituents, sulfates, phosphates, alkalinity, coliform density and specific conductance throughout the test period. This difference is most probably caused by the higher water (P. 9-21)

Table 9-3

LONG ISLAND GROUND WATER POLLUTION STUDY

Site No. 5 - Reduction in Sewage Constituents Through
Sewage Disposal Systems to Ground WaterTest Product LAS

<u>Constituent</u>	<u>Average Concentration (mg/l)</u>		<u>Percent Reduction</u>
	<u>Septic Tank</u>	<u>Test Wells*</u>	
MBAS	9.8	5.94	39.2
Nitrogen (as N)			
Ammonia	61.2	34.4	43.8
Nitrites	0	0.13	
Nitrates	<u>0</u>	<u>18.5</u>	
Total N	61.2	53.03	13.0
Chlorides	56.2	48.8	13.0
Sulfates	16.4	55.4	
Phosphates (total)	57.5	21.3	63.0
Alkalinity	306.0	199.9	34.8
Specific Conductance	646.0	537.5	17.0
Coliforms (MPN/100ml)	2.23×10^6	2.27×10^3	99.9

*Data includes test wells numbers 2 through 10 but not including numbers 5 and 8.

Table 9-4

LONG ISLAND GROUND WATER POLLUTION STUDY

Site No. 5 - Reduction in Sewage Constituents Through
Sewage Disposal Systems to Ground WaterTest Product AS

<u>Constituent</u>	<u>Average Concentration (mg/l)</u>		<u>Percent Reduction</u>
	<u>Septic Tank</u>	<u>Test Wells*</u>	
MBAS	6.2	3.21	48.2
Nitrogen (as N)			
Ammonia	79.0	26.13	66.8
Nitrites	0.02	0.05	
Nitrates	<u>0.72</u>	<u>33.38</u>	
Total N	79.74	59.56	25.0
Chlorides	51.8	45.6	22.0
Sulfates	10.2	41.4	-406.0
Phosphates (total)	64.2	11.4	82.8
Alkalinity	422.	143.1	66.1
Specific Conductance	840.	516.6	38.4
Coliforms (MPN/100ml)	5.89×10^6	0.61×10^2	99.9

*Data includes test wells numbers 2 through 10 but not including numbers 5 and 8.

Table 9-5

LONG ISLAND GROUND WATER POLLUTION STUDY

Site No. 5 - Reduction in Sewage Constituents Through
Sewage Disposal Systems to Ground Water

Test Product SOAP

<u>Constituent</u>	<u>Average Concentration (mg/l)</u>		<u>Percent Reduction</u>
	<u>Septic Tank</u>	<u>Test Wells*</u>	
MBAS	1.01	2.15	-210.
Nitrogen (as N)			
Ammonia	81.3	26.6	67.4
Nitrites	0.01	0.23	
Nitrates	<u>0.03</u>	<u>27.7</u>	
Total N	81.34	54.53	33.0
Chlorides	61.3	49.4	19.0
Sulfates	1.8	26.3	—
Phosphates (total)	49.3	15.9	67.8
Alkalinity	481.3	149.96	68.9
Specific Conductance	795.	516.3	35.2
Coliforms (MPN/100ml)	1.68×10^6	0.88×10^3	99.94

*Data includes test wells numbers 2 through 10 but not including numbers 5 and 8.

Table 9-6

LONG ISLAND GROUND WATER POLLUTION STUDY

Site No. 5 - Reduction in Sewage Constituents Through
Sewage Disposal Systems to Ground WaterTest Product ABSAverage Concentration (mg/l)

<u>Constituent</u>	<u>Septic Tank</u>	<u>Test Wells*</u>	<u>Percent Reduction</u>
MBAS	11.70	2.85	75.7
Nitrogen (as N)			
Ammonia	61.54	36.9	40.0
Nitrites	0.01	0.12	
Nitrates	<u>0.4</u>	<u>23.8</u>	
Total N	61.95	60.82	2.0
Chlorides	52.0	51.1	1.5
Sulfates	3.1	19.1	—
Phosphates (total)	62.64	19.04	69.5
Alkalinity	437.6	237.8	45.0
Specific Conductance	727.0	556.0	23.7
Coliforms (MPN/100ml)	1.68×10^6	0.64×10^3	99.96

*Data includes test wells numbers 2 through 10 but not including numbers 5 and 8.

Table 9-7

LONG ISLAND GROUND WATER POLLUTION STUDY

Site No. 6 - Reduction in Sewage Constituents Through
Sewage Disposal Systems to Ground WaterTest Product LAS

<u>Constituent</u>	<u>Average Concentration (mg/l)</u>		<u>Percent Reduction</u>
	<u>Septic Tank</u>	<u>Test Wells*</u>	
MBAS	26.0	7.95	69.5
Nitrogen (as N)			
Ammonia	102	57.1	45.5
Nitrites	0.02	0.09	
Nitrates	<u>0</u>	<u>1.07</u>	
Total N	102.02	58.26	43.0
Chlorides	105.5	78.4	25.0
Sulfates	100	82.5	17.5
Phosphates (total)	103	0.163	99.84
Alkalinity	491	316.2	35.5
Specific Conductance	1050	700.6	33.0
Coliforms (MPN/100ml)	1.66×10^6	8.7×10^3	99.93

*Data includes test wells numbers 2 through 13 but not including number 7.

Table 9-8

LONG ISLAND GROUND WATER POLLUTION STUDY

Site No. 6 - Reduction In Sewage Constituents Through
Sewage Disposal Systems to Ground WaterTest Product AS

<u>Constituent</u>	<u>Average Concentration (mg/l)</u>		<u>Percent Reduction</u>
	<u>Septic Tank</u>	<u>Test Wells*</u>	
MBAS	16.2	3.5	78.0
Nitrogen (as N)			
Ammonia	95.5	73.3	23.0
Nitrites	0.02	0.05	
Nitrates	<u>0.08</u>	<u>5.3</u>	
Total N	95.6	78.6	18.0
Chlorides	107.	84.2	21.5
Sulfates	46.2	45.4	02.
Phosphates (total)	100.	0.14	99.86
Alkalinity	546.	378.	30.8
Specific Conductance	1240.	879.	29.0
Coliforms (MPN/100ml)	8.78×10^6	6.14×10^3	99.86

*Data includes test wells numbers 2 through 13 but not including number 7.

Table 9-9

LONG ISLAND GROUND WATER POLLUTION STUDY

Site No. 6 - Reduction in Sewage Constituents Through
Sewage Disposal Systems to Ground WaterTest Product SOAP

<u>Constituent</u>	<u>Average Concentration (mg/l)</u>		<u>Percent Reduction</u>
	<u>Septic Tank</u>	<u>Test Wells*</u>	
MBAS	2.98	2.46	17.5
Nitrogen (as N)			
Ammonia	94.	74.66	21.0
Nitrites	0.0	0.03	
Nitrates	<u>0.05</u>	<u>0.676</u>	
Total N	94.05	75.37	20.0
Chlorides	97.1	79.3	13.5
Sulfates	26.6	8.9	67.7
Phosphates (total)	53.7	0.08	99.85
Alkalinity	325.	436.1	(34.2)
Specific Conductance	993.	814.9	27.0
Coliforms (MPN/100ml)	1.84×10^6	8.77×10^3	99.52

Number in parenthesis represents increase.

Table 9-10

LONG ISLAND GROUND WATER POLLUTION STUDY

Site No. 6 - Reduction in Sewage Constituents Through
Sewage Disposal Systems to Ground WaterTest Product ABS

<u>Constituent</u>	<u>Average Concentration (mg/l)</u>		
	<u>Septic Tank</u>	<u>Test Wells*</u>	<u>Percent Reduction</u>
MBAS	12.5	3.44	74.5
Nitrogen (as N)			
Ammonia	116.	68.1	41.3
Nitrites	0	0.01	
Nitrates	<u>0</u>	<u>0.03</u>	
Total N	116.	68.14	41.3
Chlorides	96.	78.6	18.0
Sulfates	21.	4.90	86.6
Phosphates (total)	70.	0.21	99.7
Alkalinity	580.	488.6	15.7
Specific Conductance	1,180.	836.0	39.0
Coliforms (MPN/100ml)	4.3×10^6	1.27×10^4	99.7

*Data includes test wells numbers 2 through 13 but not including number 7.

consumption at Site 5 and the basic difference in the character of the sewage produced. The levels of some constituents may be influenced by the differences in age and type of tile field system as well as by the soil properties at the site. These characteristics would not, however, explain higher chloride values. The several constituents are discussed separately in the following sections.

Chlorides

The background chloride concentrations at Site 5 varied between 5.7 and 57. with an average value of 24.1. Site 6 values varied from 2 to 16 with an average of 6.1 mg/l. (Table 4-1)

The chloride concentration in the septic tank at Site 5 varied between averages of 51 and 61 mg/l for the periods in which four products were tested. Site 6 chlorides averaged between 96 and 107 reflecting different but consistent characteristics for the site.

The average values in the ground water below the tile field were from 1.5-22 mg/l at Site 5 and 14 to 25 at Site 6.

The chloride data was used to compute the dilution factors for evaluating the removals of various constituents in passage through the disposal system. The dilution factor was applied in two ways. In most instances percent removal of chlorides was subtracted from percent removal of each constituent. For more refined analyses, the dilution factor was applied on the basis of the relationship:

$$C_{bgd} (X) \pm C_{st} (1) = C_{gw} (X \pm 1)$$

Where C is concentration in mg/l of chlorides

bgd - background wells

st - septic tank

gw - ground water

Table 9-11

CHLORIDE REDUCTION THROUGH PERCOLATION FIELD

<u>Test Product</u>	<u>LAS</u>		<u>AS</u>		<u>Soap</u>		<u>ABS</u>	
	5	6	5	6	5	6	5	6
Average Chloride Concentrations (mg/l)								
Background	28	6	26	4	16	6	24	8
Septic Tank	56	102	51	107	61	97	52	96
Gd Water Below Tile Field	49	58	46	84	49	79	51	79
Percent Reduction	13	43	9	22	19	14	2	18
Avg. Dilution Factor (f)	1.25	1.28	1.28	1.34	1.33	1.13	1.15	1.25

Notes

1. Values of chloride concentrations are average of daily values for background wells and for septic tanks. Values for ground water are the average of daily median values of test wells beneath tilefield.
2. Average dilution factor is the average of factors computed for each day and includes those values which are less than unity representing ground water concentrations exceeding that of the sewage effluent.

The dilution factor, f , equals $1 \pm X$, and is a multiplication factor to correct for dilution. A summary of chloride data is tabulated in Table 9-11.

MBAS as ABS

Methylene blue active substances, MBAS, measured as ABS, varied significantly for each product tested at both tile field sites in terms of contributions to the system and removal in passage through the percolation field. Summary of values is shown in Table 9-12.

Background concentrations of MBAS were not significant at either Site 5 or Site 6.

Septic tank concentrations at Site 5 were more consistent and higher on the basis of levels computed from product consumption than on the basis of analyses of septic tank samples. During use of LAS, AS, and ABS at Site 5, the computed ABS varied from 21.0 to 29.0 mg/l, while the actual ABS varied from 6.2 to 11.7 mg/l. At Site 6 the computed values were more erratic but also significantly higher than the actual. Computed values of MBAS in the septic tank varied between 15.3 and 48.7. The actual values ranged between 12.5 and 25.1 mg/l.

Reduction of MBAS in passage through the system was on the whole appreciably higher at Site 6 than at Site 5 in spite of the higher concentration in the septic tank to begin with. The higher efficiency is attributed to higher adsorption capability due to the newness of the system at Site 6 as well as to the finer sub-soils existing there.

The removal of MBAS during use of soap as a test product is significant insofar as it demonstrates the desorption phenomena. During the use of soap on Site 5, the level of MBAS in the groundwater below the tile field actually increased from that in the septic tank. This purging action of ABS from the soil is also reflected in the improvement of MBAS removal demonstrated at both

Table 9-12

MBAS In mg/l

Site 5

<u>Test Product</u>	<u>LAS</u>	<u>AS</u>	<u>Soap</u>	<u>ABS</u>
Background	.0	.0	.03	.04
Septic Tank (computed)	29.7	23.7	0	21.0
" " (actual)	9.9	6.2	1.0	11.7
Ground water (actual)	5.9	3.3	1.9	2.9
Ground water adjusted for dilution *	7.5	5.1	2.4	3.3
Percent reduction (incr)	17.7	8.9 (167.0)		60.4

Site 6

<u>Test Product</u>	<u>LAS</u>	<u>AS</u>	<u>Soap</u>	<u>ABS**</u>
Background	0	0	0	0
Septic Tank (computed)	20.7	15.3	0	48.5
" " (actual)	25.1	16.2	3.0	12.5
Ground water (actual)	7.9	3.3	1.9	2.2
Ground water adjusted for dilution	10.0	3.8	2.1	2.75
Percent Reduction	55.7	53.4	37.0	77.8

*Values for ABS in ground water adjusted for dilution represent average of daily median values of MBAS adjusted for dilution based on assumption of conservative properties of chlorides. Values other than for computed MBAS in septic tank represent average of daily median values.

**Represents analysis of single day's samples.

sites after the soap use interval. At Site 5 removal of MBAS after soap use was 60 percent compared to pre-soap values of 18 and 9 percent. At Site 6 the removal was 78 percent as opposed to 56 and 53 percent prior to soap use.

Infra-red analyses

Infra-red analyses for the differentiation between branch chain and straight chain ABS were not conducted at Sites 5 or 6. It is therefore not possible to evaluate the persistence of different formulations in travel through a tile field type of sewage system.

Dissolved Oxygen (D.O.)

The average D.O. concentrations in the ground water upstream from the disposal system varied between 0.35 and 1.08 mg/l at Site 5 and between 3.1 and 8.73 at Site 6. The higher D.O. at Site 6 reflects the relatively recent development of the general environs at Site 6 compared to Site 5. The D.O. in the ground water beneath the tile fields revealed several conditions of interest. The wells which were rejected from the several analyses as not representative because of the demonstrated clogging of the tile lines in the vicinity, or due to the presence of generally impervious soil at the well point, were found in general to be appreciably higher in D.O. than the other wells. Well #8 at Site 5 for example, had a minimum D.O. of 2.8 mg/l and a high of 5.2, while the average test well values varied between 0.2 and 1.6 for the entire test.

The concentration of D.O. in the ground water beneath the tile fields was significantly lower than at the background wells indicating the significant oxygen demand in the effluent from the sewage systems. The average D.O. for representative wells beneath tile fields is shown in the following tabulation.

Dissolved Oxygen in Groundwater Beneath Tile Field (mg/l)

<u>Site</u>	<u>Detergent Product</u>			
	<u>LAS</u>	<u>AS</u>	<u>Soap</u>	<u>ABS</u>
5	0.41	0.88	0.92	1.18
6	1.04	0.24	0.21	0.18*

*Represents analyses of a single day's samples

pH

The pH of all phases of the test sites for all test products remained relatively constant. Average background values throughout the study at Site 5 varied from 5.41 to 5.76 and at Site 6 from 6.0 to 6.8.

Values in the ground water below the tile field were equally consistent. The range at Site 5 of average values was between 5.85 and 6.18 and at Site 6 between 6.5 and 6.9. The pH data is summarized in the following table:

pH (Average Value for each Test Product)

<u>Sites</u>	<u>LAS</u>		<u>AS</u>		<u>Soap</u>		<u>ABS</u>	
	5	6	5	6	5	6	5	6*
Background	5.7	6.0	5.8	6.0	5.5	6.5	5.4	6.8
Septic Tank	6.8	6.9	7.0	6.8	6.9	7.0	7.0	7.1
Gd water below tile fld	6.2	6.5	5.9	6.5	6.1	6.9	6.1	6.7

*Represents analyses of single day's samples.

Ammonia

Free ammonia was not present in the background wells to any significant extent. The range of values for the two test sites during use of four test products varied between 0 and 0.23 mg/l.

The ammonia concentration in the septic tank samples were higher at Site 6 (average of 94 to 116 mg/l) than at Site 5 (average 61 to 81) due to differences

In sewage characteristics.

Values in the ground water beneath the tile fields were lower at Site 5 (average 26 to 37 mg/l) than at Site 6 (average 57 to 75 mg/l) reflecting the more dilute sewage and the significant conversion to nitrate nitrogen. The reduction at Site 5 through the system were roughly 67 percent during the tests of AS and soap, three times that at Site 6. Reductions at Site 5 were approximately 40 percent during use of LAS and ABS which was equivalent to the reduction at Site 6 during the same periods. A summary of ammonia data is tabulated below:

<u>Test Product</u>	<u>Average Values of Free Ammonia (mg/l)</u>								
	<u>LAS</u>		<u>AS</u>		<u>Soap</u>		<u>ABS</u>		
	<u>Site</u>	<u>5</u>	<u>6</u>	<u>5</u>	<u>6</u>	<u>5</u>	<u>6</u>	<u>5</u>	<u>6</u>
Background	0.2	0.23	1.2	0.18	0.22	0.21	0.14	0	
Septic Tank	61	102	79	96	81	94	62	116	
Gd water below tile fld	34	57	26	73	27	75	37	68	
Reduction	27	45	53	23	54	19	25	48	
Percent Reduction	44	46	67	23	67	21	40	41	

Nitrites

Nitrites were present at low concentrations throughout all parts of the systems at both sites. The nitrites present in the septic tank and in the ground water below the tile fields represent early stages in the conversion of ammonia to nitrates. Nitrites in the background wells represent the final stage of the conversion of other upstream sources. Nitrite data is summarized together with nitrate data.

Nitrates

Nitrates were erratic in the background well at Site 5 with average values

between 1.5 and 14.3 mg/l. Values at Site 6 were more consistent at lower average levels of 0.2 to 0.5 reflecting the lower degree of ground water pollution in the Bellmore area.

Nitrates were not present to any significant extent in the two septic tanks as anticipated.

Concentration in the ground water below the tile fields was fairly constant at Site 5 with average levels between 18.5 and 33.4 mg/l. Values at Site 6 were much lower averaging between zero and 5.3. The larger capability of the system at Site 5 to convert ammonia to nitrates is unique compared to all other test sites. One explanation may be that an external source of nitrogen is present at the site, originated perhaps from lawn fertilizers applied on the site. The attendant reduction in ammonia from septic tank to ground water may be attributed to absorption in the septic tank sludge or on the soil particles in the unsaturated zone. It is also possible that the generally low concentration of sewage at Site 5 coupled with a well aerated soil, may represent optimum conditions for conversion of ammonia to nitrates. A summary of nitrogen data is shown in Table 9-13.

Table 9-13

NITROGEN VALUES

<u>Test Product</u>	<u>LAS</u>		<u>AS</u>		<u>Soap</u>		<u>ABS</u>	
	5	6	5	6	5	6	5	6
<u>Site</u>								
<u>Background</u>								
Ammonia	0.2	0.2	1.2	0.2	0.2	0.2	0.1	0
Nitrite	0.1	0.2	0.1	0.1	0	0	0	0
Nitrate	5.5	0.5	14.3	0.3	1.5	0.2	1.7	0.2
Total N	5.8	0.9	15.6	0.6	1.7	0.4	1.8	0.2
<u>Septic Tank</u>								
Ammonia	61	102	79	95.5	81.3	94	61.5	116
Nitrite	0	0	0	0	0	0	0	0
Nitrate	0	0	0.7	0.1	0	0.1	0.4	0
Total N	61	102	79.7	95.6	81.3	94.1	62.0	116
<u>Ground Water</u>								
Ammonia	34.4	57.1	26.1	73.3	26.6	74.7	36.9	68.1
Nitrite	0.1	0.1	0.1	0.1	0.2	0	0.1	0
Nitrate	18.5	1	33.4	5.3	27.7	0.7	23.8	0
Total N	53.0	58.2	59.6	78.6	54.5	75.4	60.8	68.1
Percent Removal of N (S.T. to GW)	13	43	25	18	33	20	2	41

Sulfates

Concentrations of sulfates in the background demonstrated the higher ground water pollution in the environs of Site 5 where average values were between 62.0 and 86.0 mg/l. At Site 6, the average values were between 20.2 and 30.8.

Sulfate levels in the septic tanks were erratic and generally not consistent with the variation in sulfur content of the detergent test products. Levels at Site 5 varied between 1.8 and 16.4 mg/l, and at Site 6, between 21.0 and 100.0 mg/l. Lower concentrations of 1.8 and 27.0 respectively were observed during the use of soap. Site 6 values were fourfold to sevenfold higher than at Site 5.

Sulfate values in the ground water beneath the tile fields were also erratic and three to thirteenfold higher than in the septic tank at Site 5. At Site 6 all values were lower than the septic tank values but the percent reduction varied in the approximate range of 20 to 75 percent. These values are probably associated with the high background levels and lower disposal system values at Site 5 and the variable dilution provided to the ground water by the sewage effluent at the site. A summary of sulfate data is tabulated below:

Sulfate Concentration (mg/l)

<u>Test Product</u>	<u>LAS</u>		<u>AS</u>		<u>Soap</u>		<u>ABS</u>	
	5	6	5	6	5	6	5	6
Background	62.0	30.8	86.0	25.2	65.6	20.2	71.8	23.0
Septic Tank	16.4	100.0	10.2	46.2	1.8	27.0	3.1	21.0
Ground Water	55.4	82.5	41.4	45.4	26.3	9.0	19.1	5.0

Phosphates

Phosphates were not found to be present in significant quantities in the background at either site.

Values in the septic tanks were higher at Site 6 in the order of 100 mg/l for the test products which contained a large proportion of phosphates and 50 mg/l during the use of soap. Site 5 phosphates averaged between 57 and 64 mg/l except during soap use when the average value dropped to 49.3 mg/l. These values appear to reflect the level of phosphates in the detergent test products modified by phosphates normally present in dishwasher detergent.

The reduction of phosphates through the tile fields was dramatic, achieving average reductions of between 63 and 83 percent at Site 5 and almost complete reduction at Site 6. Site 6 efficiency is attributed to optimum conditions for phosphate removal, namely finer soil to encourage entrapment of precipitated phosphates as well as the relatively new unsaturated soil horizon which would enhance adsorption potential. Removals through the system at the two tile field sites were in the order of 100 percent higher than at the cesspool sites. The relative efficiency of the tile field system is probably due to the larger area of soil-sewage interface and a flow path in the unsaturated zone of a much larger cross-section thereby enhancing biological efficiency, and adsorption potential in removing phosphates.

<u>Test Product</u>	<u>Total Phosphate (mg/l)</u>							
	<u>LAS</u>		<u>AS</u>		<u>Soap</u>		<u>ABS</u>	
	5	6	5	6	5	6	5	6
Background	0.05	0.21	0.04	0.05	0.03	0.09	0.01	0.03
Septic Tank (ST)	57.5	103	64.2	100	49.3	53.7	62.6	70.0
Ground Water below tile field (GW)	21.3	0.2	11.4	0.14	15.9	0.1	19.0	0.2
Percent Reduction (ST to GW)	63.0	99.8	82.8	99.8	68.9	99.8	69.5	99.7

Coliform Organisms

The log average coliform concentrations in the upstream wells were in the range of 16 to 57/100 ml at Site 5 and 50 to 1,191/100 ml at Site 6. The higher background values at Site 6 are not consistent with the generally less polluted ground water conditions there and appears due to some local influence.

Septic tank concentrations at Site 6 were in a higher order of magnitude (8.8×10^6 to 1.8×10^7) compared to Site 5 (1.7×10^6). The range of values for both sites is consistent with cesspool and septic tank values in other sites.

The concentration of coliforms in the ground water below the tile fields was generally one order higher at Site 6 than at Site 5 reflecting the higher concentration in the septic tank at Site 6. Reductions in the category of 99.9 percent or greater were achieved at Site 5 for all test products. Reduction at Site 6 varied from 99.52 to 99.86 percent.

There appears to be no significant difference in coliform concentrations in the system or reductions through the systems during the use of different detergent test products except that lesser reductions through the system were achieved at Site 6 during use of soap and ABS test products. A summary of coliform data for the tile field sites is shown in Table 9-14.

Alkalinity

The background alkalinity at both sites during all phases of the test was consistent between values of 9 and 18 mg/l as calcium carbonate.

Average concentrations in the septic tank were not consistent for each site or for the various test products. Site 6 values were higher for all test products than Site 5 except during use of soap when Site 5 alkalinity was higher. Concentrations varied between 306 mg/l at Site 5 during LAS tests to 580 at Site 6 during ABS use.

Alkalinity values in the ground water beneath the systems varied significantly with no regularity. A low average value of 150 mg/l was observed at Site 5

Table 9-14

COLIFORM ORGANISMS (LOG AVERAGE MPN/100 ml)

Test Product Site	<u>LAS</u>		<u>AS</u>		<u>Soap</u>		<u>ABS</u>	
	5	6	5	6	5	6	5	6
Background	16.4	243.4	56.8	1191.0	49.7	49.5	-	-
Septic Tank	2.2×10^6	1.7×10^7	5.9×10^6	8.8×10^6	1.7×10^6	1.8×10^7	1.7×10^6	4.3×10^6
GW below Tile Fld.	2.3×10^3	8.7×10^3	6.0×10^2	6.1×10^3	0.9×10^3	8.8×10^3	6.4×10^2	1.3×10^4
Percent Reduction	99.91	99.95	99.98	99.86	99.94	99.52	99.96	99.70

during soap tests and a high value of 489 mg/l at Site 6 during ABS use. Percent removal at both sites were consistent at 35 during LAS use. The removal at Site 5 during AS use (66 percent) was twice that at Site 6 and during ABS tests (45 percent) was threefold that at Site 6. During soap use, the removal at Site 5 was 69 percent while the alkalinity at Site 6 actually increased in value by 34 percent. Alkalinity data is summarized in Table 9-15.

Specific Conductance

The background levels of specific conductance were lower at Site 6, averaging from 46 to 73 micro-mhos/cm, than at Site 5, where the averages varied from 170 to 278. This is another indication of the better ground water quality at Site 6. Specific conductance values in the background were consistent with other sites.

The septic tank values were consistently higher at Site 6 (993 to 1240 micro-mhos/cm) corresponding to higher values for other sewage constituents. Site 5 average values were between 646 and 840. Overall, the values were in the same range as at the other test sites.

The reduction in specific conductance through the tile fields varied between 17 and 38 percent, not considering dilution factors. Site 5 reductions were higher during AS and soap tests at 38 and 35 percent respectively, compared to 29 and 18 percent at Site 6. During LAS and ABS tests, Site 6 reductions were higher, averaging 33 and 29 percent respectively compared to 17 and 24 percent at Site 5.

Removals at the two tile field sites were in the same order of magnitude as Site 1 and Site 3 removals measured from cesspool to first group of wells. Values were higher, however, than experienced at Site 2. A summary of specific conductance data for the two tile field sites is shown in Table 9-16.

Table 9-15

ALKALINITY (mg/l as CaCO₃)

<u>Test Product</u>	<u>LAS</u>		<u>AS</u>		<u>Soap</u>		<u>ABS</u>	
	5	6	5	6	5	6	5	6*
Background	16	16	18	13	10	21	9	14
Septic Tank	306	491	422	546	481	325	438	580
GW below Tile Fld	200	316	143	378	150	436	238	489
Percent Reduction (Increase)	35	35	66	31	69	(34)	45	16

*Represents results of a single day's sample.

Table 9-16

SPECIFIC CONDUCTANCE (micro-mhos/cm)

<u>Test Product</u>	<u>LAS</u>		<u>AS</u>		<u>Soap</u>		<u>ABS</u>	
	5	6	5	6	5	6	5	6*
Background	268	73	278	65	176	46	170	50
Septic Tank (ST)	646	1050	840	1240	795	993	727	1180
GW below Tile Field (GW)	538	701	517	879	516	815	556	836
Percent Reduction ST to GW	17	33	38	29	35	18	24	29

*Represents analyses of a single day's sample.

Chemical Oxygen Demand (COD)

COD analyses were not conducted at either Site 5 or 6.

Biochemical Oxygen Demand (BOD)

The average BOD of the septic tank samples varied considerably at each site for the several test products. The overall range was between 170 mg/l for ABS and 349 mg/l during soap use, both at Site 6. The BOD during LAS and ABS use was equivalent at both sites. During AS and soap use, however, Site 6 values were in the order of 100 mg/l higher than at Site 5. Values during use of soap were not comparatively higher than for other test products as experienced at Sites 1 and 2. The BOD during use of ABS was appreciably lower than for the other test products at both Sites 5 and 6. A summary of BOD data is tabulated below:

BOD (mg/l) in Septic Tanks

<u>Test Product</u>	<u>LAS</u>	<u>AS</u>	<u>Soap</u>	<u>ABS</u>
Site 5	328	252	266	180
Site 6	311	360	349	170

Total and Suspended Solids

The total solids in the septic tanks varied directly with the BOD levels for both sites during use of LAS, AS and ABS test products with relatively lower solids levels during use of ABS. Values ranged between 840 and 930 mg/l at Site 5 and between 480 and 915 mg/l at Site 6. During the use of soap, the total solids were relatively higher with respect to the BOD at Site 5 and lower with respect to BOD at Site 6.

Suspended solids values in the septic tanks were approximately 25 percent of the total solids at both sites during LAS use, 15 percent during AS use, and 30 percent during ABS use. The suspended solids value at Site 5 during soap use

was 17 percent of the BOD and at Site 6, 30 percent of the BOD. A summary of total and suspended solids data is tabulated below:

<u>Total Solids/Suspended Solids (mg/l)</u>				
<u>Test Product</u>	<u>LAS</u>	<u>AS</u>	<u>Soap</u>	<u>ABS</u>
Site 5	847/215	619/105	930/157	541/165
Site 6	702/176	915/168	670/188	480/380

Comparison with Other Studies

California Study

The removal of synthetic detergents from trench type soil adsorption systems was also studied by the University of California¹ on a modified prototype system under controlled conditions. The California Study was conducted in a simulated prototype septic tank tile field system in which the septic tank had normal field dimensions except that the width was three (3) inches. The tile field simulator was an artificially constructed unit of four (4) compartments each of which was four (4) feet long and three (3) feet wide. The sand medium used was a slightly acid mixed alluvium of excellent subsurface drainage characteristics. A tile trench was constructed in each compartment at a cross-section one (1) foot square and was four (4) feet long. Each trench was filled with gravel (one-quarter ($\frac{1}{4}$) to one-half ($\frac{1}{2}$) inch size) surrounding a four (4) inch fiber drain pipe centered in the trench section. The top of the gravel trench was covered with four (4) inches of sand, the top of which was exposed to the atmosphere.

Sewage consisted of settled, ground municipal sewage which was fed at six (6) equal doses in a 16 hour day. To each dose, a sufficient quantity of test detergent was added to provide a 25 mg/l concentration.

Samples were collected of the influent and effluent of the septic tank and the effluent of the tile field. Tests were conducted over a period of 116 days

using ABS, 85 days for LAS and 116 days for AS. Analyses for the synthetic detergent material were made using colorimetric and radioassay techniques.

Comparison of Studies

The mechanics of the two studies permit comparison of data relating to the removal of several synthetic detergent products in passage through the percolation field. A summary of the removal efficiencies is shown in Table 9-17.

The results show a wide variation and appear to be contradictory. Several factors become evident, however, on careful analysis of the conditions under which the two studies were conducted. These differences in study conditions dramatize not only research difficulties but illustrate the significance of several natural phenomena which are involved in the sewage disposal systems studied. Each factor is discussed separately.

Dissolved Oxygen (DO)

The biochemical degradation which takes place in a percolation field must of necessity occur at the sewage-soil interface where both zoogeleal life and oxygen are present. The sewage arriving at this interface is septic and the only source of oxygen is through the voids of the surrounding soil in communication with the atmosphere. The presence of DO in the effluent from a percolation field is therefore significant in demonstrating adequate conditions for aerobic degradation within the system.

The trench effluent in the California study revealed substantial oxygen content throughout the tests. The lowest DO value observed was 1.4 mg/l. This was true in spite of the sewage inundation to which the system was subjected in order to develop critical conditions. It is therefore apparent that the aerobic degradation capability was unaffected during the conduct of the tests.

The percolation field effluent in the Long Island study could not be isolated and was sampled together with the receiving ground water. The DO of the combined

effluent and ground water had a maximum value of 1.18 mg/l at Site 5 and 1.04 mg/l at Site 6. Background DO was generally in the same range or higher and could conceivably be the source of all oxygen present in the ground water beneath the field. Some of the chemical oxygen demand of the sewage effluent moreover, may have been satisfied by the oxygen present in the ground water as the effluent reached the static water table.

The higher oxygenation potential of the California system is attributable first to the newness of the system with a total life of approximately 3 months. The relative age of the systems also affects oxygenation capability as it relates to the mechanical clogging of the soil interstices by inert material in the sewage and progressive accumulations of precipitation products such as ferric sulfide. Anaerobic conditions were evident at Site 5 during site development in locating the tile trenches. This factor alone could account for the higher overall reductions achieved in the California tests and at Site 6 as compared to Site 5 with a system life of 8 years.

Oxygenation is also enhanced in the California system due to a unique physical feature - the minimal 4 inches of sand cover over the gravel filled trench which assured an aerobic condition at the sewage-soil interface. The cover on the Long Island sites consists of 31 to 44 inches of soil including an organic mantle.

Adsorption Versus Biodegradation

The adsorption in the percolation field reported in the California study was 12.3 percent and 31.3 percent for LAS and AS respectively. By the nature of the adsorption phenomena, this portion of the removal is gradually reduced as the saturation capacity of the sewage sludge and soil is satisfied until ultimate adsorption rate becomes insignificant. Removal in the Long Island study was not separated into adsorption and biodegradation aspects but it appears that

the total removal reported includes appreciably less adsorption than experienced in the California study due to the relatively older systems studied particularly at Site 5.

Sewage Characteristics

The influent BOD in the California study was lower and more uniform than found in typical domestic disposal systems on Long Island. California septic tank BODs in the initial phase of the study varied only within the extreme values of 115 and 173 mg/l. The BOD variation from the 34th to the 78th day was a maximum 14 mg/l. It is assumed that this same sewage source was used for the supplemental studies discussed herein. The Long Island study was not as accurate in collecting the actual septic tank effluent but data obtained revealed a much greater range and higher values in BOD. It is assumed that under the conditions studied that the range in levels in BOD would also reflect a wide variation in several other characteristics and constituents which would mitigate against the establishment of an efficient and optimum degradation environment even if other conditions, such as presence of DO and absence of toxic materials, permitted.

Laboratory Versus Field Conditions

The construction of the California apparatus, although providing ideal control conditions for a study of this type, nevertheless, does not accurately reproduce field conditions. The results of such a study are therefore subject to confirmation in the field before results may be considered representative.

Conclusions

On the basis of the wide variation in conditions present in the two studies it is readily apparent that the results would vary markedly. The accuracy of the data under the conditions studied in California is greater than in the Long Island study because of the better control afforded and the opportunity to perform both colorimetric and radiological analyses. On the other hand, a large

number of known and probably several unknown factors are present in an in situ investigation which affect the fate of synthetic detergents and cannot be incorporated into a bench study. Data from the Long Island study is therefore considered more significant in the prediction of the extent of ground water contamination caused by synthetic detergents.

1. Klein, Stephen A., "Supplementary Report on The Fate of Detergents in Septic Tank Systems and Oxidation Ponds", May 1, 1964, Sanitary Research Laboratory, College of Engineering and School of Public Health, University of California. (SERL Report No. 64-1 Supplement)

Table 9-17

REMOVAL OF SYNTHETIC DETERGENTS BY PERCOLATION FIELDS

Percent Reduction Through Percolation Field

	<u>LAS</u>	<u>AS</u>	<u>ABS</u>
University of California Study*	88.1	36.3	44.7
Long Island Ground Water Pollution Study**			
Site 5	17.7	8.9	60.4
Site 6	55.7	53.4	77.8

*Percent removal through percolation field shown is difference between reported overall removal through system and removal by septic tank alone.

**Percent removal through percolation field is determined as difference between average observed concentration in septic tank and average of daily medians of observed concentrations in ground water below tile lines adjusted to account for dilution based on conservative property of chlorides.

Part 10 - Radioactive Tag Studies

Objectives

Initiation of a radioactive material tracer study on Site 3 was undertaken to substantiate and augment results obtained by ordinary chemical testing procedures and also to get a deeper insight into the degradation of surfactants.

Primary objectives of the radio-tagging process were:

1. To obtain an estimate of the liquid flow rate through the unsaturated zone to the ground water.
2. To obtain an estimate of the flow rate in the saturated or ground water zone.
3. To determine the residence time and rate of travel of the detergent molecule as compared to the liquid in both the unsaturated and saturated zones.
4. To ascertain the degradability of the straighter chain, LAS, surfactant and extent of the degradation process.
5. To measure the relative magnitude of dilution resulting from ground water flow.

Radioactive tracer materials used were tritium to trace the flow of the liquid and sulphur³⁵, tagged detergent, to depict the movement of LAS surfactant.

Two separate tracer studies were undertaken. The Phase 1 project entailed a single application of radioactive materials into the disposal system. Phase 11 consisted of a continuous application of radioactive materials into the cesspool for a time period sufficient to establish steady state conditions in the disposal system and downstream observation wells for a period of at least two weeks.

Health Hazards

The project was conducted so that no public health hazard associated with the introduction, collecting and analyzing of samples would occur. Also, that

no hazard would occur to persons utilizing ground waters downstream from the test site.

Tritium and sulphur³⁵ were introduced into the cesspool by breaking the capsule containing these materials at mid-depth below the liquid level. Breakage of the capsule below the liquid level minimized the possible release of activity to the air or persons administering the capsule. A special device was used to introduce and break the capsule in the cesspool.

The device consisted of a cross welded to the bottom of a 2-inch pipe. The capsule was lowered to the cross where it was supported, then the pipe lowered to about mid-liquid depth of the cesspool. A 3/4 inch pipe plunger was introduced into the 2 inch pipe, thereby smashing the capsule containing the radioactive material.

After the introduction of the tagged material, mixing was done by introducing either air or water through the 2 inch pipe.

All radioactive material was stored prior to use in secured containers properly posted at the laboratory of the Suffolk County Water Authority. Only authorized persons were permitted in the immediate area of the stored materials. Each capsule containing the daily dose of radioactivity was transported in a protective container from the laboratory to the test site.

Personnel collecting and transferring radioactive samples into shipping containers for transport to the Western New York Nuclear Research Center were instructed in proper handling procedures and required to use protective clothing. Cesspool isotope concentrations and daily dosages were based upon physical characteristics of the system and allowable maximum permissible concentrations, MPC's, at outer observation wells. It was also assumed that no other factors besides that of ground water dilution and decay contributed to changes in concentration of these radioisotopes.

Prime consideration was given to the fact that no one utilizing the ground waters would be unduly subject to a significant health hazard during and subsequent to the radio tag study. There were no known downstream wells within 1000 feet of the sewage disposal system of Site 3.

Sampling and Analysis Procedures

The collection of samples at each sampling point was performed by representatives of the Suffolk County Health Department and the Suffolk County Water Authority. Shipment of the samples were made to the Western New York Nuclear Research Center where the samples were analyzed for tritium, total sulfur³⁵ and undegraded LAS³⁵ (containing more than 8 carbon atoms in the NaLAS molecule). Both air express and parcel post special handling were used as services for transporting the samples. The samples were contained in dark brown polyethylene bottles with tops sealed in wax. In each case, the bottle was completely filled with 130 ml of sample. Degradation of the LAS molecule was prevented between sample collection and analysis by either the introduction of formaldehyde in the sample bottle and/or the autoclaving of the sample.

Analysis other than radioactivity determinations were also made concurrently during the course of this study. Tritium analyses were made by sample distillation, addition of scintillator to the distillate and then counting of the mixture in a Packard Tri-Carb liquid scintillation counter.

Total sulfur³⁵ analyses were performed by: first, double filtration to remove suspended impurities, then evaporating the filtrate to dryness, redissolving the solids and adding a scintillation mixture prior to counting in a Packard Tri-Carb counter. The degraded sulfur LAS³⁵ determination was made by adding cetyltrimethyl ammonium bromide (CTAB) to the balance of the sample prepared for total sulfur³⁵ scintillation counting. The extraction of LAS³⁵ from the mixture into chloroform was performed, then evaporated to dryness. A scintillation mixture

was added for counting the residue which remained after the drying process.

In preparation for the radioactive study, a review was made of existing test shaft and downstream well data, sample volumes collected and general functioning of the disposal system. Following modifications were made to the system prior to the Phase I study:

1. The cesspool was pumped out and refilled with waste material from Site 2 which was using LAS surfactant.
2. The household was switched from ABS to LAS test surfactant.
3. Additional samplers were installed at the three levels in the sampling shaft.
4. Soil core samples were collected at the time of installation of the samplers.

Phase I

On the morning of May 11, 1965, radioactive tagged materials were introduced into the cesspool. Phase I was a single application of radioactive materials into the cesspool consisting of 11.05 millicuries of sulfur³⁵ and 42.6 millicuries of tritium. The sulfur³⁵ was bound to a detergent identified as NaLAS³⁵. These quantities of materials resulted in first day activity levels in the cesspool of:

Tritium	1.25×10^{-2} mc/ml
Total Sulfur	2.66×10^{-3} mc/ml
Undegraded Sulfur	3.02×10^{-3} mc/ml

Based upon an average water use of about 265 gallons daily and cesspool volume of approximately 1,320 gallons, the cesspool was diluted 50 percent every 2 1/2 days, which generally agreed with the decay in activity observed within the cesspool.

The concentration of each radioisotope was about equal to or less than their respective Maximum Permissible Concentrations allowed in drinking water for

radiation workers.

A water meter and recording chart were installed on the water line to determine dilution characteristics within the cesspool and how this would affect activity levels. In addition a liquid level recorder was placed on the cesspool to show the daily variation in depth of liquid wastes contained in the cesspool. Water usage by this family varied anywhere from 12 to 60 cubic feet daily. In an effort to reduce this extreme variation, water was added at the time samples were collected from the system to assure a minimum daily flow of 30 cubic feet into the disposal system.

Cesspool

Functioning of the cesspool appeared to have a direct relationship on the quantity of sample obtained from the samplers beneath the cesspool. About the first of June, some clogging occurred in the bottom of the cesspool at the same time the middle sampler stopped producing a daily sample.

A decrease in the rate of decay of activity occurred in the cesspool beginning about June 1, concurrent with a marked rise in the liquid level of the cesspool. (Table 10-1)

The cesspool was aerated on several occasions during the Phase I program, on June 9 and 16, and prior to the study, on April 23 and 30. After each aeration, the liquid level in the cesspool dropped significantly and the middle sampler responded with increased sample volumes.

The aeration procedure involved injection of compressed air from a portable compressor with hose connected to a long length of iron pipe. Bottom of pool was scoured with the air for several hours.

Top Samplers

Samples from the top tensiometer contained activity concentrations for the first five days indicative of the conditions prevailing in the cesspool. After

this time, however, the activity leveled off and remained at approximately the same concentration for about 20 days. (Table 10-1) The reason for this phenomenon was not understood.

Comparable activity levels appeared to lag about 1 1/2 to 2 days in the tensiometers from that in the cesspool.

Middle Samplers

On May 26 samples were collected from both the middle tensiometer and gravity sampler. Comparison of activities in these samples were not appreciably different with regard to tritium and undegraded sulfur³⁵ results. There was, however, a factor of two involved between the total and undegraded sulfur³⁵ levels.

Sampling was not started early enough to obtain the first appearance of activity at this sampling point.

Bottom Samplers

At no time during the study was it possible to collect significant samples from any of the bottom samplers.

Observation Wells

Generally, sampling was not initiated early enough nor sufficient samples analyzed to properly identify the peak activity as the slug passed through the downstream sampling wells. (Table 10-1)

The Phase I study ended on June 18, 1965. Data is plotted in Figures 10-1 through 10-8.

Phase II

Phase II, continuous application of radioisotopes, sulfur³⁵ and tritium into the cesspool started on September 29, 1965. The purpose of the continuous dosage was to achieve equilibrium or steady state conditions within the cesspool and downstream sampling locations for at least a two-week period.

Prior to initiation of the Phase II study, results obtained from the Phase I program and functioning of the cesspool and sampling devices were reviewed so that changes could be made to the system to assure more satisfactory operation of the disposal system and sample collection system. Modification to the system prior to Phase II were:

1. The ground water level dropped about 6 inches since the conclusion of the Phase I study and initiation of Phase II. This necessitated deepening the sampling wells utilized in the Phase I program.
2. There was some rehabilitation and relocation of the gravity samplers.
3. A new system was initiated utilizing a vacuum pump for collecting samples from the downstream wells.
4. The bottom of the cesspool was thoroughly agitated with compressed air prior to administering the radioactive tracers.

The initial dose of tritium and sulfur³⁵ was 9.0 and 4.57 millicuries (mc), respectively into a cesspool liquid volume of about 2,640 gallons. Daily dosages after the first day were 1.0 and 0.5 mc for tritium and sulfur³⁵, respectively, being introduced for 39 days thereafter, but with three days being missed, October 11, 12, and 13. On October 14 the daily dosage for the previous three days were added together with the dosage for October 14.

Design concentrations of tritium and sulfur³⁵ in the cesspool were 1×10^{-3} and 5×10^{-4} , respectively. The sum of the ratios of these concentrations to their respective permissible levels in drinking waters for radiation workers equaled about 25 percent of the allowable. Therefore, the health hazard involved was minimal.

The last day of daily dosage application occurred on December 7, 1965. Cesspool bottom sludge and soil core sample activity determinations in addition to the liquid sample analysis were performed by the Western New York Nuclear Research

Center.

Generally, all samplers produced sufficient daily samples except the bottom. When insufficient daily sample volume resulted, samples from more than one day were composited.

Cesspool

The average waste discharge to the cesspool for the first 30 days was about 32 cubic feet per day. With the exception of one day, this flow did not deviate more than 3 cubic feet from the average. The liquid content of the cesspool receded to about 2,180 gallons or a reduction of about 17 percent of its original liquid volume during the initial 30 days of the Phase II study.

It was not necessary to agitate the pool bottom with air during this phase of the project.

Steady state concentrations in the disposal system averaged about 1.2×10^{-3} and 2.4×10^{-4} uc/ml for tritium and Total sulfur³⁵, respectively. Data for Phase II study is shown in Table 10-2. Results are plotted in Figures 10-9 through 10-17.

The new gravity samplers responded well to the introduction of the tracer materials.

Middle Samplers

Erratic results at the beginning of Phase II for sulfur as well as some unreasonably high tritium levels were obtained from the middle gravity samplers.

Bottom Samplers

Generally, the bottom samplers did not receive a sufficient amount of activity to properly evaluate the velocity, dilution or degradation factors.

Test Wells

The arrival of activity at the downstream observation wells could not be accurately distinguished and erratic values of ground water velocities resulted.

Activity levels in the downstream wells were generally too low to draw any positive conclusions.

Sludge samples from the cesspool were analyzed for total and undegraded sulfur³⁵ to determine adsorption and degradation of the surfactant which became associated with the bottom sludge materials. Attempts to collect sludge samples by a bomb sampler were unsuccessful. This procedure was later superseded by utilizing a bottle taped to the end of a 20-foot length of pipe. The stopper was removed once the bottle reached the cesspool bottom, then the sample brought up in the unstoppered bottle.

Soil core samples to determine the extent of degradation of surfactant adsorbed on the soil particles were taken between Well No. 6 and the wall of the cesspool. The method used for procuring these core samples was not entirely satisfactory. To drive the core drill rig, water was used for flushing materials from the drive core, resulting in samples which were not representative because fines had been removed and also possibly some of the detergent material. This practice was discontinued, and an auger core used for collection of the remaining samples of the first batch. No record of the procedure and exact location of the second and third core samples was available.

Results of the soil core samples collected on September 6, 11, and November 9, with reference to total sulfur content only, are not valid since the procedures utilized for making this determination were unsatisfactory. Likewise, sludge samples collected on September 29, October 4, 10, 18 and November 1 were affected in the same way. All other total sulfur results are satisfactory. All of the undegraded sulfur determinations were satisfactory. Data is shown in Table 10-3.

Table 10-1 - Radioisotope Activity
Phase I - Radioactive Tagging Study (Site 3)

Cesspool Samples (Collected at Mid-Liquid Depth)

<u>Date Collected</u>	<u>Sample Identification</u>	<u>uc/ml × 10⁻⁴ Results H³</u>	<u>uc/ml × 10⁻⁵</u>	
			<u>Total Sulfur</u>	<u>Undegraded Sulfur</u>
5/11/65	CP #1	125	286	324
5/12/65	CP #2	92.8	211	235
5/13/65	CP #3	79.4	179	200
5/14/65	CP #4	49.6	109	132
5/15/65	CP #5	42.3	88.2	104
5/18/65	CP #6	13.5	26.9	35.8
5/21/65	CP #7	8.31	16.3	17.2
5/24/65	CP #8	3.41	5.76	7.32
5/28/65	CP #9	1.32	2.59	3.15
6/1/65	CP #10	0.478		2.10
6/7/65	CP #11	0.133	0.367	.550
6/1/65	CP #12	0.524	1.07	1.34
6/12/65	CP #13	None	0.242	0.306

Top Tensiometer Long (Located 18 inches Below Bottom of Cesspool)

<u>Date Collected</u>	<u>Sample Identification</u>	<u>uc/ml × 10⁻³ Results H³</u>	<u>uc/ml × 10⁻⁵</u>	
			<u>Total Sulfur</u>	<u>Undegraded Sulfur</u>
5/12/65	TTL (1)	0.744	2.69	1.08
5/13/65	TTL (2)	4.25	17.4	8.90
5/14/65	TTL (3)	4.08	12.6	11.7
5/15/65	TTL (4)	2.83	10.7	10.5
5/16/65	TTL (5)	2.25	9.48	9.04
5/19/65	TTL (6)	2.00	8.74	8.40
5/22/65	TTL (7)	2.02	6.41	5.88
6/1/65	TTL (8)	1.22	3.69	3.58
5/25/65	TTL (9)	2.06	6.01	5.78

Table 10-1 - Radioisotope Activity (continued)
Phase I - Radioactive Tagging Study (Site 3)

Middle Gravity Long (Located 5 Feet Below Bottom of Cesspool)

<u>Date Collected</u>	<u>Sample Identification</u>	<u>uc/ml × 10⁻³ Results H³</u>	<u>uc/ml × 10⁻⁵</u>	
			<u>Total Sulfur</u>	<u>Undegraded Sulfur</u>
5/15/65	MGL #1	4.73	18.1	10.7
5/16/65	MGL #2	4.91	20.3	11.4
5/17/65	MGL #3	4.62	19.1	10.5
5/18/65	MGL #4	4.23	19.0	10.3
5/19/65	MGL #5	3.76	19.1	9.22
5/20/65	MGL #6	3.23	17.4	7.40
5/23/65	MGL #7	2.10	13.6	4.86
5/13/65	MGL #8	3.78	10.0	5.91
5/26/65	MGL #9	1.36	11.7	4.00

Middle Tensiometer Short (Located 5 Feet Below Bottom of Cesspool)

5/26/65	MTS #1	2.64	6.46	3.12
---------	--------	------	------	------

Well No. 6 (Located 5 Feet From Center of Cesspool)

5/30/65	W 6A	1.01	17.3	3.86
6/2/65	W 6B	0.407	8.07	2.22
5/27/65	W 6C	1.80	25.3	4.91
6/5/65	W 6D	0.260	10.4	1.83
6/8/65	W 6E	0.229	9.79	1.71

Well No. 8 (Located 10 Feet From Center of Cesspool)

6/2/65	W 8A	1.52	21.3	4.4
6/8/65	W 8C	0.434	9.67	1.83

Well No. 10 (Located 15 Feet From Center of Cesspool)

6/2/65	W 10A	2.80	22.4	6.23
6/5/65	W 10B	3.20	29.0	6.69
6/7/65	W 10C	2.56	31.5	4.71
6/12/65	W 10D	1.11	15.7	2.32

Well No. 9A (Located Same Distance as Well #10 From Cesspool, Only One Foot Less In Depth)

5/28/65	W 9A 1	2.41	10.1	3.83
5/31/65	W 9A 2	3.57	22.6	5.51

Table 10-1 - Radioisotope Activity (continued)
Phase I - Radioactive Tagging Study (Site 3)

Well No. 13 (Located 25 Feet From Center of Cesspool)

6/2/65	W 13A	0.645	3.37	1.08
6/8/65	W 13B	1.33	6.05	1.62
6/5/65	W 13C	1.01	4.91	1.58
6/10/65	W 13D	1.29	4.59	1.51
6/14/65	W 13E	1.28	6.65	2.18
6/7/65	W 13F	1.34	7.61	1.71
6/18/65	W 13H	1.54	.385	2.55

Well No. 17 (Located 45 Feet From Center of Cesspool,
 Depth of Well One Foot Deeper Than Other
 Wells With Exception of Well No. 9A)

<u>Date Collected</u>	<u>Sample Identification</u>	<u>uc/ml × 10⁻⁵ Results H³</u>	<u>uc/ml × 10⁻⁷</u>	
			<u>Total Sulfur</u>	<u>Undegraded Sulfur</u>
6/7/65	W 17A	2.59	2.01	4.54
6/10/65	W 17B	3.12	10.7	6.15
6/12/65	W 17C	2.74	26.5	7.42
6/14/65	W 17D	1.26	9.47	6.02
6/18/65	W 17E	14.8	45.8	5.23

Table 10-2 - Radioisotope Activity
Phase II - Radioactive Tagging Study (Site 3)

Cesspool Sample (Collected at Mid-Liquid Depth)

<u>Date Collected</u>	<u>Sample Identification</u>	<u>uc/ml × 10⁻⁴ Results H³</u>	<u>uc/ml × 10⁻⁵ Total Sulfur</u>	<u>uc/ml × 10⁻⁵ Undegraded Sulfur</u>
9/28/65	CP #1	-	.042	< .01
9/30/65	CP #2	15.2	31.9	34.8
10/1/65	CP #3	15.2	28.2	32.3
10/2/65	CP #4	13.9	24.9	28.2
10/3/65	CP #5	13.4	21.2	24.5
10/4/65	CP #6	16.2	25.3	31.0
10/5/65	CP #7	9.11	25.5	31.2
10/6/65	CP #8	9.73	24.8	31.3
10/9/65	CP #9	11.9	23.4	25.9
*10/12/65	CP #10	10.1	22.0	23.5
10/15/65	CP #11	12.2	29.4	31.3
*10/18/65	CP #12	10.3, 11.3	23.7	28.1
*10/21/65	CP #13	11.1	23.8	27.8
*10/24/65	CP #14	10.7	22.1	27.6
10/27/65	CP #15	12.1, 10.7	24.1	26.6
10/30/65	CP #16	13.3, 12.3	23.2	24.6
11/3/65	CP #18	10.9	20.5	23.6
11/5/65	CP #19	11.6	22.1	23.8
11/8/65	CP #20	10.3	22.0	24.2
11/13/65	CP #21	7.09	16.3	18.2
11/17/65	CP #22	4.16	11.6	17.4
11/19/65	CP #23	3.46	12.4	16.0
11/22/65	CP #24	2.35	10.8	13.2
11/24/65	CP #25	1.78	9.65	10.7
11/26/65	CP #26	1.67	11.5	11.1
11/29/65	CP #27	1.32	11.4	17.7
12/1/65	CP #29	0.98	8.32	8.46
12/3/65	CP #30	0.65	6.06	7.76
12/6/65	CP #31	0.45	5.71	7.32
12/8/65	CP #32	0.27	4.74	6.77
12/17/65	CP #33	0.075	3.81	-
12/21/65	CP #34	0.091	3.32	2.77
1/24/66	CP #35	-	1.91	-
3/2/66	CP #36	-	0.865	-

*Corrected

Table 10-2 - Radioisotope Activity (continued)
Phase II - Radioactive Tagging Study (Site 3)

New Top Gravity Long Samples (Collected 18 Inches Below Bottom of Cesspool)

Date Collected	Sample Identification	uc/ml x 10 ⁻³ Results H ³	uc/ml x 10 ⁻⁵	
			Total Sulfur	Undegraded Sulfur
9/28/65	NTGL-1	.007	.518	.189
9/29/65	NTGL-2	.0035	.633	.239
10/1/65	NTGL-3	.0817	.615	.554
10/5/65	NTGL-4	.785	2.45	1.89
10/7/65	NTGL-5	1.07	3.12	2.20
*10/10/65	NTGL-6	1.16	2.39	2.25
	NTGL-10	1.20	2.78	1.89
10/9/65	NTGL-17	1.20		
10/11/65	NTGL-18	1.23		
		1.34		
10/13/65	NTGL-7	1.12	3.22	2.36
		1.03		
10/15/65	NTGL-11	0.97	2.78	1.96
*10/16/65	NTGL-8	1.00	4.77	2.27
*10/19/65	NTGL-9	1.14	4.90	2.44
*10/20/65	NTGL-12	1.18	3.38	2.32
10/22/65	NTGL-13	1.11	3.31	2.62
10/24/65	NTGL-14	1.21	3.59	2.66
	NTGL-25	1.08		
10/27/65	NTGL-15	1.19	4.31	3.08
	NTGL-26	1.14		
10/30/65	NTGL-16	1.17	4.46	2.36
	NTGL-27	1.19	6.04	2.67
11/2/65	NTGL-19	1.10	4.36	3.25
		1.14		
11/8/65	NTGL-20	1.14	5.52	1.64
11/11/65	NTGL-21	1.15	5.76	2.60
	NTGL-22	1.02	2.70	1.74
11/13/65	NTGL-23	1.05	3.34	1.98
11/17/65	NTGL-24	0.71	3.67	2.99
3/2/66	NTGL-31	< 8.5x10 ⁻⁶	0.984	0.226
3/22/66	NTGL-32	< 9.6x10 ⁻⁶	0.750	0.492

*Corrected

Top Tensiometer Long Samples (Collected 18 Inches Below Bottom of Cesspool)

9/28/65	TTL (1)	.170	.119
---------	---------	------	------

Table 10-2 - Radioisotope Activity (continued)
Phase II - Radioactive Tagging Study (Site 3)

Middle Gravity Long (Collected 5 Feet Below Bottom of Cesspool)

<u>Date Collected</u>	<u>Sample Identification</u>	<u>uc/ml × 10⁻³ Results H³</u>	<u>uc/ml × 10⁻⁵ Total Sulfur</u>	<u>uc/ml × 10⁻⁵ Undegraded Sulfur</u>
9/29/65	MGL #1	-	0.297	0.0492
9/30/65	MGL #2	0.0175	0.126	-
10/1/65	MGL #3	0.00820	0.153	-
10/2/65	MGL #4	0.0421	0.103	0.0616
10/3/65	MGL #5	0.0105	0.425	0.144
10/4/65	MGL #6	0.0526	0.419	0.0572
10/5/65	MGL #7	0.0748	0.414	0.342
10/6/65	MGL #8	0.239	0.745	0.412
10/7/65	MGL #9	0.490	1.25	0.669
10/8/65	MGL #10	0.656	1.78	0.856
10/9/65	MGL #19	1.08	2.40	1.09
10/10/65	MGL #14	1.12	1.25	1.18
		1.14		
10/11/65	MGL #20	1.15	2.02	1.48
10/12/65	MGL #11	1.51	1.59	1.50
10/15/65	MGL #12	1.06	2.78	1.54
*10/18/65	MGL #13	1.10	2.39	1.23
	MGL #32	1.03		1.62
10/21/65	MGL #15	1.25	1.85	1.34
	MGL #33	1.06		
10/24/65	MGL #16	1.20	2.26	1.57
		1.24		
*10/27/65	MGL #17	1.28	3.15	1.86
	MGL #34	1.19		
10/30/65	MGL #18	1.22	3.06	2.51
		1.14		
11/2/65	MGL #21	1.10	3.74	1.64
11/5/65	MGL #22	1.23	5.26	1.48
11/8/65	MGL #23	1.18	4.80	1.76
11/11/65	MGL #24	1.12	2.25	1.48
11/13/65	MGL #25	1.07	2.96	1.56
11/17/65	MGL #26	1.08	4.67	1.92
11/19/65	MGL #27	0.94	4.30	2.08
12/22/65	MGL #28	0.72	3.71	2.00
12/24/65	MGL #29	0.53	4.97	2.20
12/26/65	MGL #30	0.39	4.09	2.10
12/29/65	MGL #31	0.34	3.74	1.56
12/1/65	MGL #35	0.29	3.29	1.34
			2.47	
12/3/65	MGL #36	0.22	2.88	1.29
12/6/65	MGL #37	0.15	2.76	1.21
12/8/65	MGL #38	0.13	2.00	0.84
1/17/66	MGL #39	0.028	1.64	0.87
3/2/66	MGL #42	< 8.5 × 10 ⁻⁶	1.12	0.425
3/22/66	MGL #43	< 9.6 × 10 ⁻⁶	0.756	0.264

*Corrected

Table 10-2 - Radioisotope Activity (continued)
Phase II - Radioactive Tagging Study (Site 3)

New Bottom Gravity Long

<u>Date Collected</u>	<u>Sample Identification</u>	<u>uc/ml × 10⁻³ Results H³</u>	<u>uc/ml × 10⁻⁵ Total Sulfur</u>	<u>Undegraded Sulfur</u>
9/30/65	NBGL-1	.0316	.400	-
9/28/65	NBGL-2	.110	.607	-
10/1/65	NBGL-3	.0882	.458	-
10/2/65	NBGL-4	.0939	.404	-
10/3/65	NBGL-5	.135	.411	-
10/5-10/6/65	NBGL-6-7	.135	.440	-
10/7-10/8/65	NBGL-8-9	.0980	.420	-
10/9/65	NBGL-10	112*	<.0741	<.0124
10/10/65	NBGL-11	-	<.0741	-
10/11/65	NBGL-12	.0914	.169	.101
10/12/65	NBGL-13	-	.149	-
10/13/65	NBGL-14	923*	.123	.116
10/14/65	NBGL-15	.111	.293	-
10/15/65	NBGL-16	.0837	.469	-
10/18-10/19/65	NBGL-17-18	144*	.200	.151
10/21-10/24/65	NBGL-19-20	65.7*	.968	.491
10/25-10/26/65	NBGL-21-22	-	.842	.419
10/27-10/29/65	NBGL-23-24-25	.244	1.18	.575
10/30-10/31/65	NBGL-26-27	.290	1.28	.782
11/1-11/2/65	NBGL-28-29		1.34	0.10
11/3-11/5/65	NBGL-30-31-32		1.82	0.11
11/6-11/8/65	NBGL-33-34-35		1.61	0.24
11/9-11/15/65	NBGL-36-37-38		1.70	0.57
11/18-11/19/65	NBGL-39		2.46	
11/19-11/22/65	NBGL-40	1.14	2.80	1.17
11/23-11/24/65	NBGL-41	1.06	2.32	1.15
11/25-11/26/65	NBGL-42		2.26	
11/28-11/29/65	NBGL-43	1.09	2.23	0.63
12/1/65	NBGL-44		2.37	
12/3/65	NBGL-45		2.62	

*Samples were contaminated by tritium in Laboratory glassware.

Table 10-2 - Radioisotope Activity (continued)
Phase II - Radioactive Tagging Study (Site 3)

Well No. 10 (Located 15 Feet From Center of Cesspool)

<u>Date Collected</u>	<u>Sample Identification</u>	<u>uc/ml x 10⁻³ Results H³</u>	<u>uc/ml x 10⁻⁵</u>	
			<u>Total Sulfur</u>	<u>Undegraded Sulfur</u>
9/28/65	W 10-1	-	0.385	0.162
9/30/65	W 10-2	0.0398	0.354	-
10/4/65	W 10-3	0.0398	0.342	-
10/7/65	W 10-4	0.0272	0.411	-
11/11/65	W 10-5	0.95	2.70	0.54
11/13/65	W 10-6	1.01	2.20	1.21
11/17/65	W 10-7	0.95	3.43	1.26
11/19/65	W 10-8	0.93	4.90	1.58
11/22/65	W 10-9	0.88	4.22	1.54
11/24/65	W 10-10	0.88	3.96	1.89
11/26/65	W 10-11	0.84	4.80	2.48
11/29/65	W 10-12	0.85	5.17	2.37
12/1/65	W 10-13	0.78	6.65	3.34
12/3/65	W 10-14	0.75	5.85	3.46
12/6/65	W 10-15	0.73	5.24	2.64
12/8/65	W 10-16	0.60	4.11	2.13
1/7/66	W 10-17	0.074	2.39	1.10

Table 10-2 - Radioisotope Activity (continued)
Phase II - Radioactive Tagging Study (Site 3)

Well No. 11

<u>Date Collected</u>	<u>Sample Identification</u>	<u>uc/ml x 10⁻³ Results H³</u>	<u>uc/ml x 10⁻⁵</u>	
			<u>Total Sulfur</u>	<u>Undegraded Sulfur</u>
10/14/65	W 11-1	0.268	1.22	0.570
	W 11-8	0.168	0.91	0.691
10/15/65	W 11-2	-	1.02	0.594
*10/18/65	W 11-3	0.263	1.93	0.382
	W 11-10	0.283	2.28	0.575
10/20/65	W 11-4	0.305	2.67	0.660
		0.380	-	-
*10/22/65	W 11-5	0.488	2.15	0.661
	W 11-11	0.544	2.50	0.907
10/24/65	W 11-6	0.0707	0.11	0.0797
		0.0786	-	-
*10/30/65	W 11-7	0.213	1.34	0.356
	W 11-9	0.223	0.63	0.325
3/2/66	W 11-12	0.016	0.83	0.277

*Corrected

Table 10-2 - Radioisotope Activity (continued)
Phase II - Radioactive Tagging Study (Site 3)

Well No. 13 (Located 25 Feet From Center of Cesspool)

<u>Date Collected</u>	<u>Sample Identification</u>	<u>uc/ml × 10⁻³ Results H³</u>	<u>uc/ml × 10⁻⁵</u>	
			<u>Total Sulfur</u>	<u>Undegraded Sulfur</u>
9/29/65	W 13-1	-	0.251	0.0105
9/30/65	W 13-2	0.0281	0.231	-
10/4/65	W 13-3	0.0222	0.288	-
10/4/65	W 13-9	-	0.227	0.0401
10/8/65	W 13-4	0.104	0.362	-
10/8/65	W 13-10	-	0.221	0.0695
10/12/65	W 13-5	-	0.475	0.440
10/12/65	W 13-11	-	0.362	0.128
10/13/65	W 13-17	0.054	0.328	0.298
10/15/65	W 13-6	1.08	0.571	0.473
*10/18/65	W 13-7	0.067	0.536	0.164
*10/20/65	W 13-8	0.101	0.581	0.284
10/20/65	W 13-18	0.085	0.421	0.239
10/20/65	W 13-27	0.111	0.692	0.326
10/22/65	W 13-12	0.080	0.424	0.210
10/22/65	W 13-28	0.100		
10/24/65	W 13-13	0.164	0.532	0.275
	W 13-13	0.117	-	-
*10/26/65	W 13-14	0.109	0.446	0.213
10/28/65	W 13-15	0.107	0.412	0.218
	W 13-15	0.123	-	-
*10/30/65	W 13-16	0.107	0.322	0.272
11/11/65	W 13-19	0.715	1.31	0.588
11/13/65	W 13-20	0.689	1.08	0.78
11/17/65	W 13-21	0.744	2.86	2.06
11/19/65	W 13-22	0.774	2.12	1.04
11/22/65	W 13-23	0.851	3.60	2.33
11/24/65	W 13-24	0.813	2.69	1.54
11/26/65	W 13-25	0.740	3.14	2.20
11/29/65	W 13-26	0.729	2.68	1.77
12/1/65	W 13-29	0.682	2.93	1.66
12/3/65	W 13-30	0.649	1.97	1.66
12/6/65	W 13-31	0.634	1.92	1.11
12/8/65	W 13-32	0.672	1.98	1.23
1/21/66	W 14-1	0.010	0.36	0.14
3/22/66	W 14-2	0.027	0.28	0.10

*Corrected

Table 10-2 - Radioisotope Activity (continued)
Phase II - Radioactive Tagging Study (Site 3)

Well No. 6 (Located 5 Feet From Center of Cesspool)

<u>Date Collected</u>	<u>Sample Identification</u>	<u>uc/ml × 10⁻³ Results H³</u>	<u>uc/ml × 10⁻⁵</u>	
			<u>Total Sulfur</u>	<u>Undegraded Sulfur</u>
9/29/65	W 6-1	-	0.488	0.166
9/30/65	W 6-2	0.0421	0.489	-
	W 6-11	-	0.481	0.253
10/3/65	W 6-3	0.0819	0.908	-
	W 6-12	-	0.635	0.436
10/6/65	W 6-4	0.156	1.64	-
	W 6-13	-	1.46	0.900
10/8/65	W 6-5	0.243	3.18	-
10/10/65	W 6-6	0.600	5.61	1.74
10/12/65	W 6-7	0.634	4.54	1.51
10/14/65	W 6-8	0.739	2.26	1.50
10/16/65	W 6-9	0.935	5.65	5.04
	W 6-18	1.01	3.99	2.15
10/18/65	W 6-10	1.08	5.06	1.22
		0.98	-	-
*10/21/65	W 6-14	0.99	3.04	1.25
	W 6-28	0.997	3.41	1.11
10/24/65	W 6-15	0.99	3.79	1.48
	W 6-29	1.04	4.24	1.20
10/27/65	W 6-16	1.07	3.53	0.94
	W 6-30	1.06	3.37	1.13
10/30/65	W 6-17	1.00	3.45	1.10
	W 6-19	1.12	2.85	1.32
11/11/65	W 6-20	0.88	2.25	1.23
11/13/65	W 6-21	0.63	1.41	0.89
11/17/65	W 6-22	0.37	1.39	0.79
11/19/65	W 6-23	0.33	1.61	0.27
11/22/65	W 6-24	0.38	1.81	0.80
11/24/65	W 6-25	0.35	1.99	1.11
11/26/65	W 6-26	0.36	2.46	1.29
11/29/65	W 6-27	0.36	2.41	1.02
12/1/65	W 6-31	0.37	2.12	0.66
12/3/65	W 6-32	0.37	2.65	1.54
12/6/65	W 6-33	0.41	2.85	1.29
12/8/65	W 6-34	0.38	2.66	1.56
1/17/66	W 6-36	0.12	1.44	0.57
3/2/66	W 6-37	<8.5 × 10 ⁻⁶	1.23	0.45

*Corrected

Table 10-3 - Radioisotope Activity
Phase II - Radioactive Tagging Study (Site 3)

Sludge - Soil Core Samples

<u>Date Collected</u>	<u>Sample Identification</u>	uc/100g x 10 ⁻⁵	
		<u>Total Sulfur</u>	<u>Undegraded Sulfur</u>
Soil Cores 9/6/65	#1	4.31	10.5
	#2	8.62	17.1
	#3	6.17	10.2
	#4	< 1.44	8.3
	#5	< 1.13	4.2
11/9/65	#1	311	164
	#2	13.0	26.3
	#3	12.2	20.9
	#4	16.6	28.1
	#5	6.2	7.96
12/28/65	K	678.0	284.0
	L	163.0 & 122.0*	71.0 & 98.0*
	M	46.1	28.4
	N	17.6 & 15.5*	13.5 & 12.2*

<u>Date Collected</u>	<u>Sludge Identification</u>	uc/g x 10 ⁻⁴	
		<u>Total Sulfur</u>	<u>Undegraded Sulfur</u>
Sludge			
9/29/65	#1	1.81	1.53
10/4/65	#2	111	38.5
10/10/65	#3	108	158
10/18/65	#4	190	142
11/1/65	#5	180	254
11/5/65	#6	284	111
11/15/65	#7	136	63.0
11/19/65	#8	120	48.9
11/24/65	#9	248	109
11/26/65	#10	171	83.5
11/29/65	#11	123	43.2

LONG ISLAND GROUND WATER POLLUTION STUDY
CESSPOOL SAMPLES
RADIOACTIVE TAGGING
SITE 3 BOHEMIA, SUFFOLK COUNTY

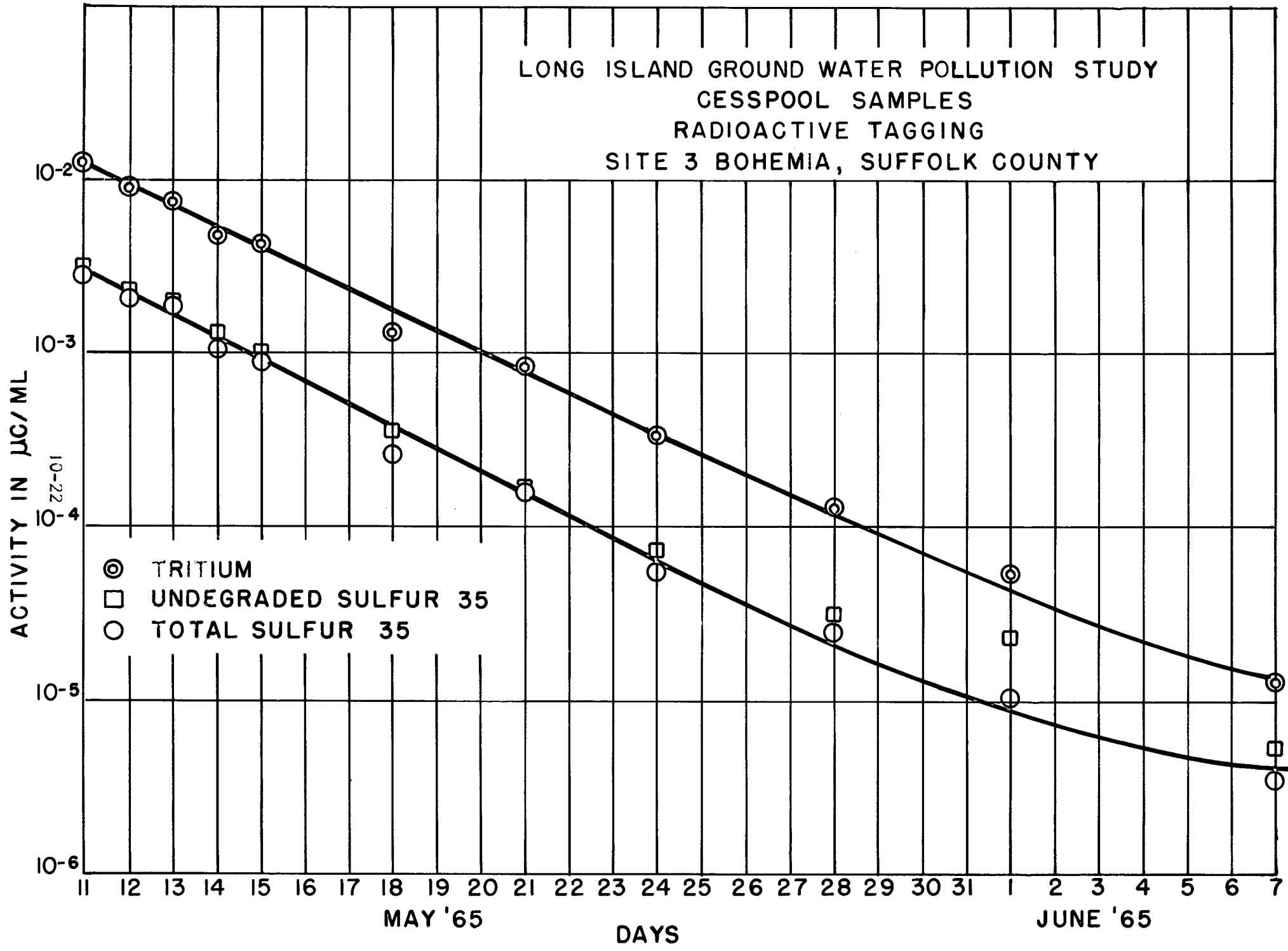
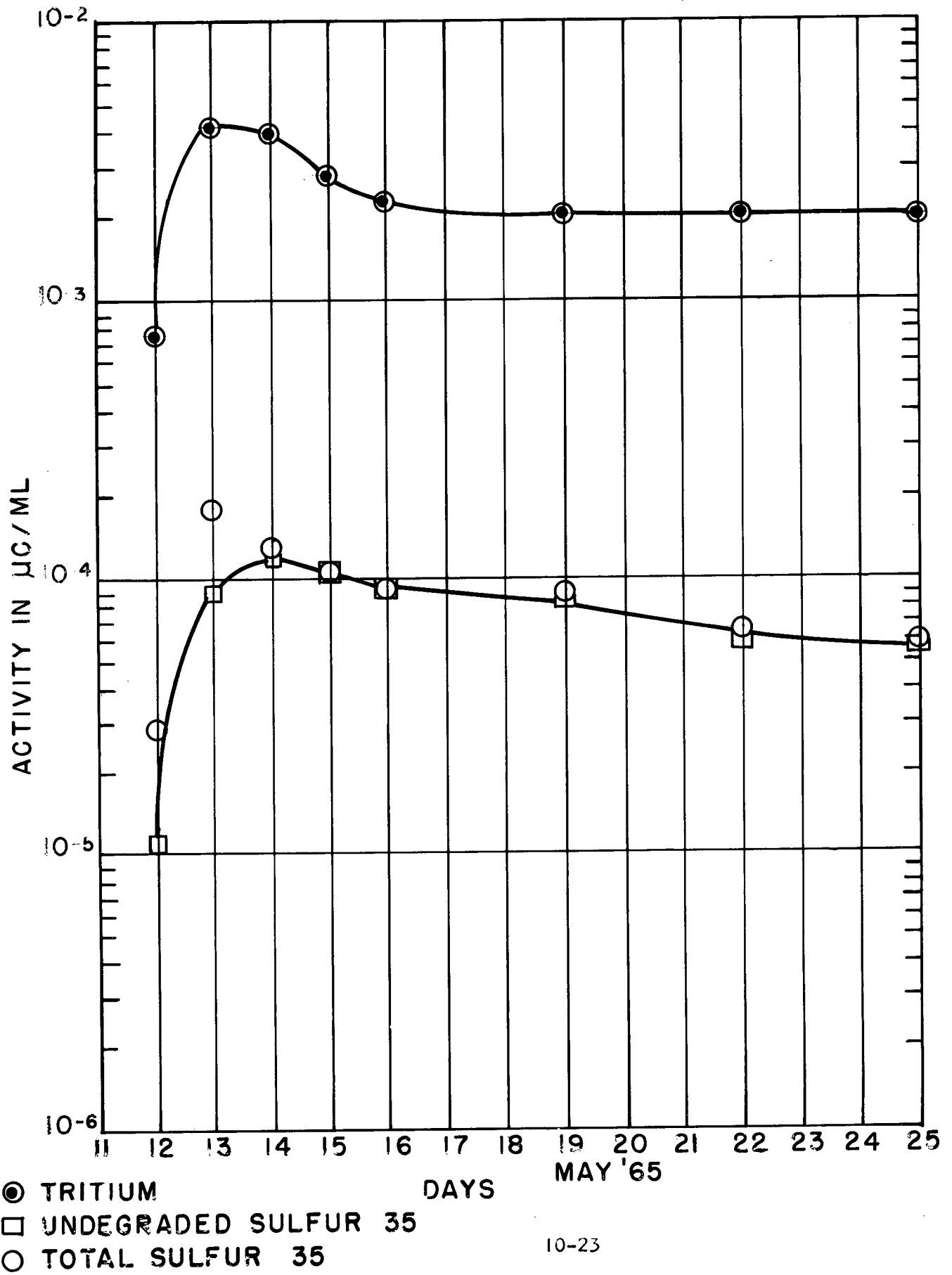
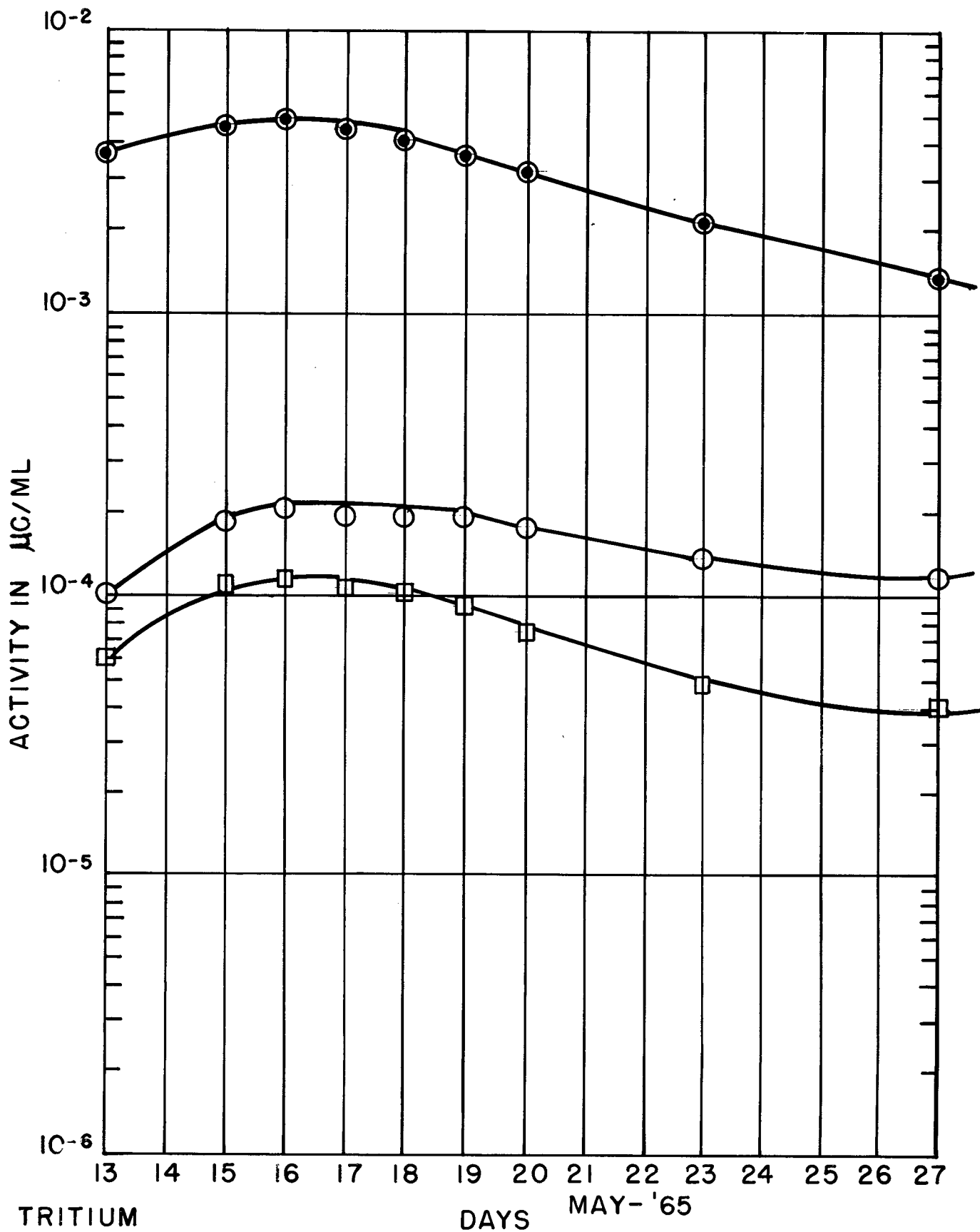

FIG. 10-1

LONG ISLAND GROUND WATER POLLUTION STUDY
 TOP TENSIMETER SAMPLES
 RADIOACTIVE TAGGING
 SITE 3 BOHEMIA, SUFFOLK COUNTY



LONG ISLAND GROUND WATER POLLUTION STUDY
 MIDDLE GRAVITY LONG SAMPLES
 RADIOACTIVE TAGGING
 SITE 3 BOHEMIA, SUFFOLK COUNTY



- TRITIUM
- UNDEGRADED SULFUR 35
- TOTAL SULFUR 35

LONG ISLAND GROUND WATER POLLUTION STUDY
 WELL NO. 6 SAMPLES
 RADIOACTIVE TAGGING
 SITE 3. BOHEMIA, SUFFOLK COUNTY

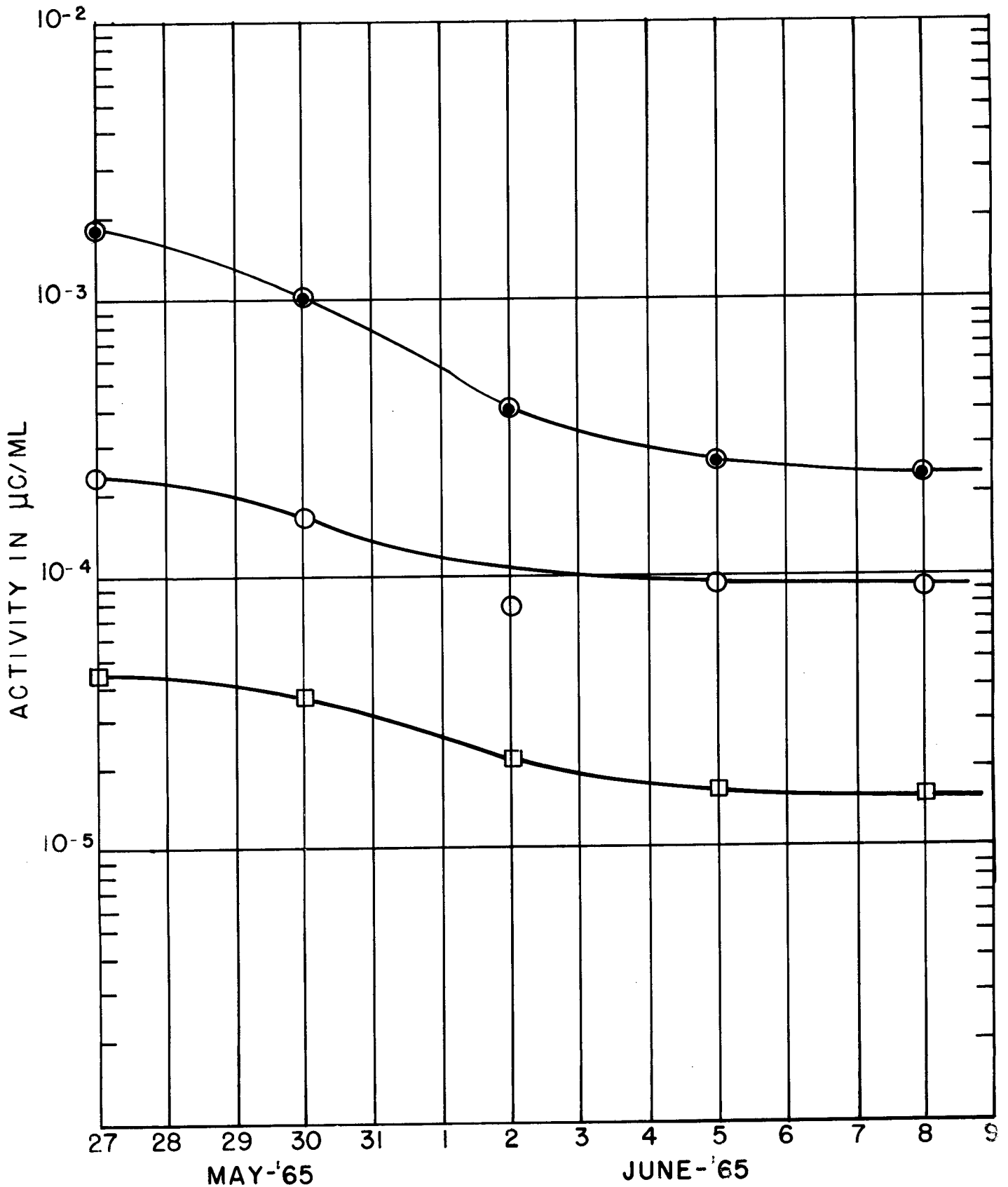

- TRITIUM
 - UNDEGRADED SULFUR 35
 - TOTAL SULFUR 35
- DAYS

10-25

LONG ISLAND GROUND WATER POLLUTION STUDY
 WELL NO. 8 SAMPLES
 RADIOACTIVE TAGGING
 SITE 3. BOHEMIA, SUFFOLK COUNTY

FIG. 10-5

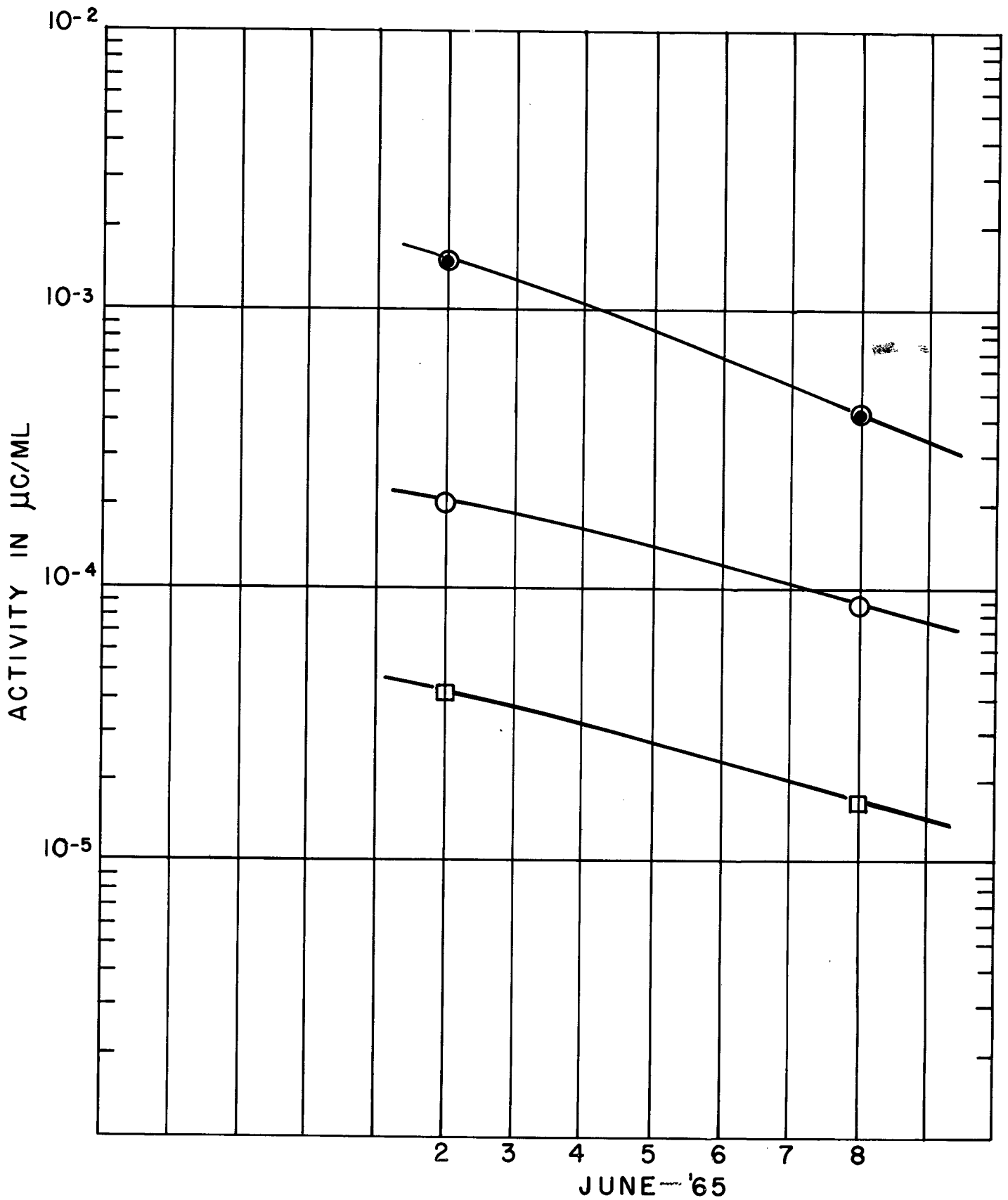

- TRITIUM
- UNDEGRADED SULFUR 35
- TOTAL SULFUR 35

DAYS

10-26

LONG ISLAND GROUND WATER POLLUTION STUDY
 WELL NOS. 98 10 SAMPLES
 RADIOACTIVE TAGGING
 SITE 3 BOHEMIA, SUFFOLK COUNTY

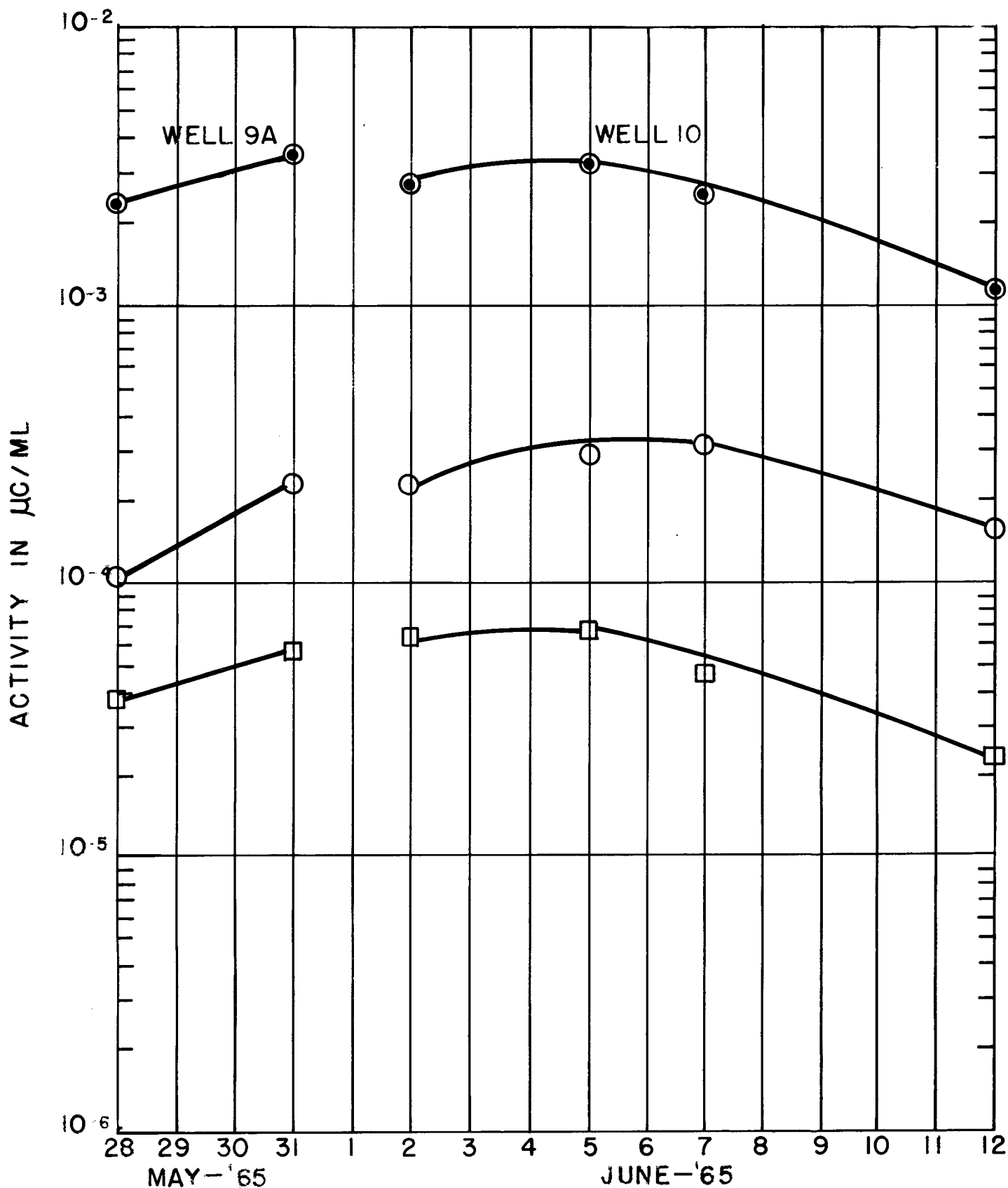

● TRITIUM
 □ UNDEGRADED SULPHUR 35
 ○ TOTAL SULPHUR 35

DAYS

LONG ISLAND GROUND WATER POLLUTION STUDY
WELL NO. 13 SAMPLES
RADIOACTIVE TAGGING
SITE 3. BOHEMIA, SUFFOLK COUNTY

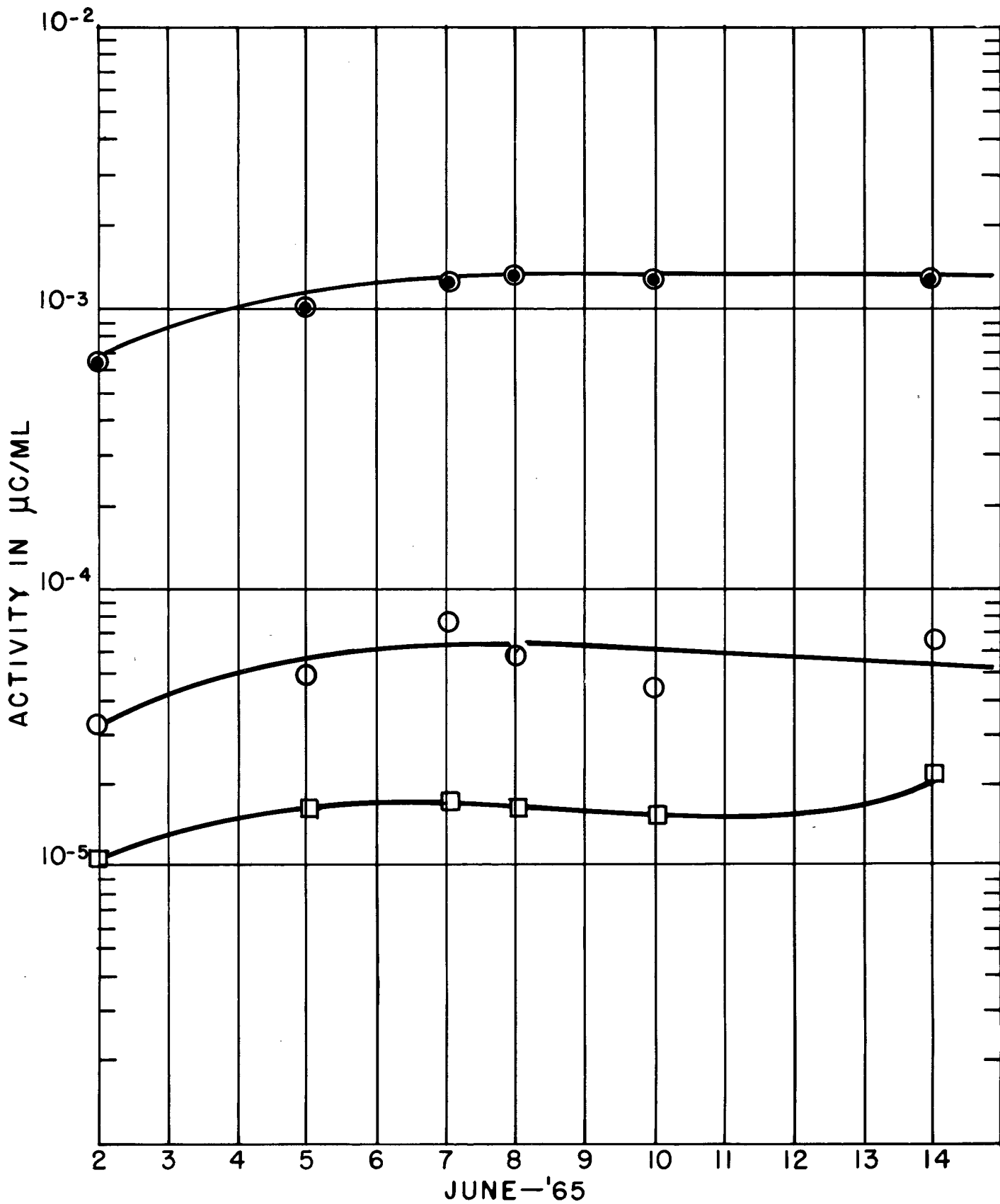

- TRITIUM
 - UNDEGRADED SULFUR 35
 - TOTAL SULFUR 35
- DAYS
- JUNE-'65
- 10-28

LONG ISLAND GROUND WATER POLLUTION STUDY
WELL NO. 17 SAMPLES
RADIOACTIVE TAGGING
SITE 3. BOHEMIA, SUFFOLK COUNTY

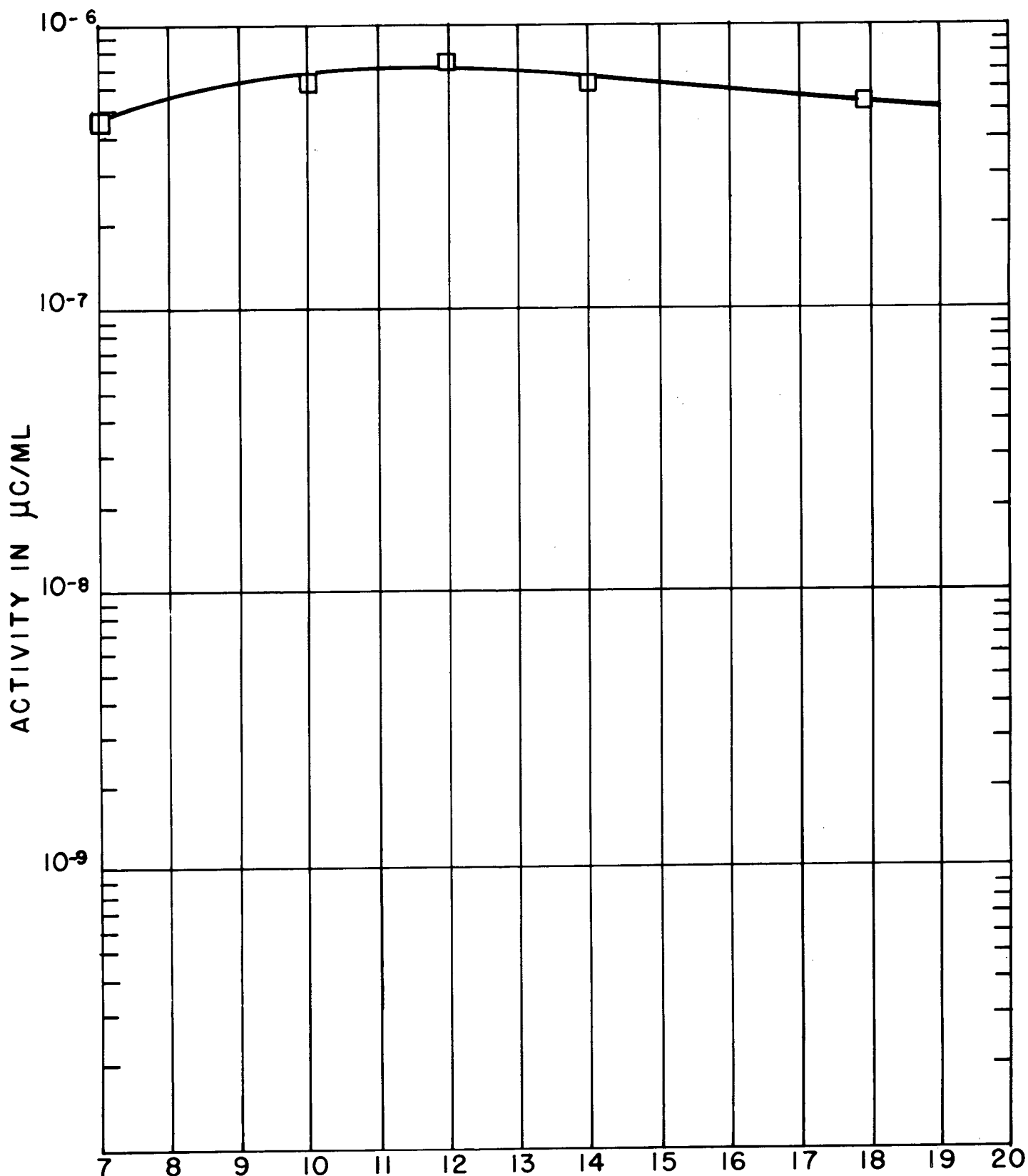

JUNE-'65
DAYS

- TRITIUM
 - UNDEGRADED SULFUR 35
 - TOTAL SULFUR 35
- 10-29

LONG ISLAND GROUND WATER POLLUTION STUDY
 CESSPOOL SAMPLE- COLLECTED AT MID-LIQUID DEPTH
 RADIOACTIVE TAGGING
 SITE 3
 PHASE II

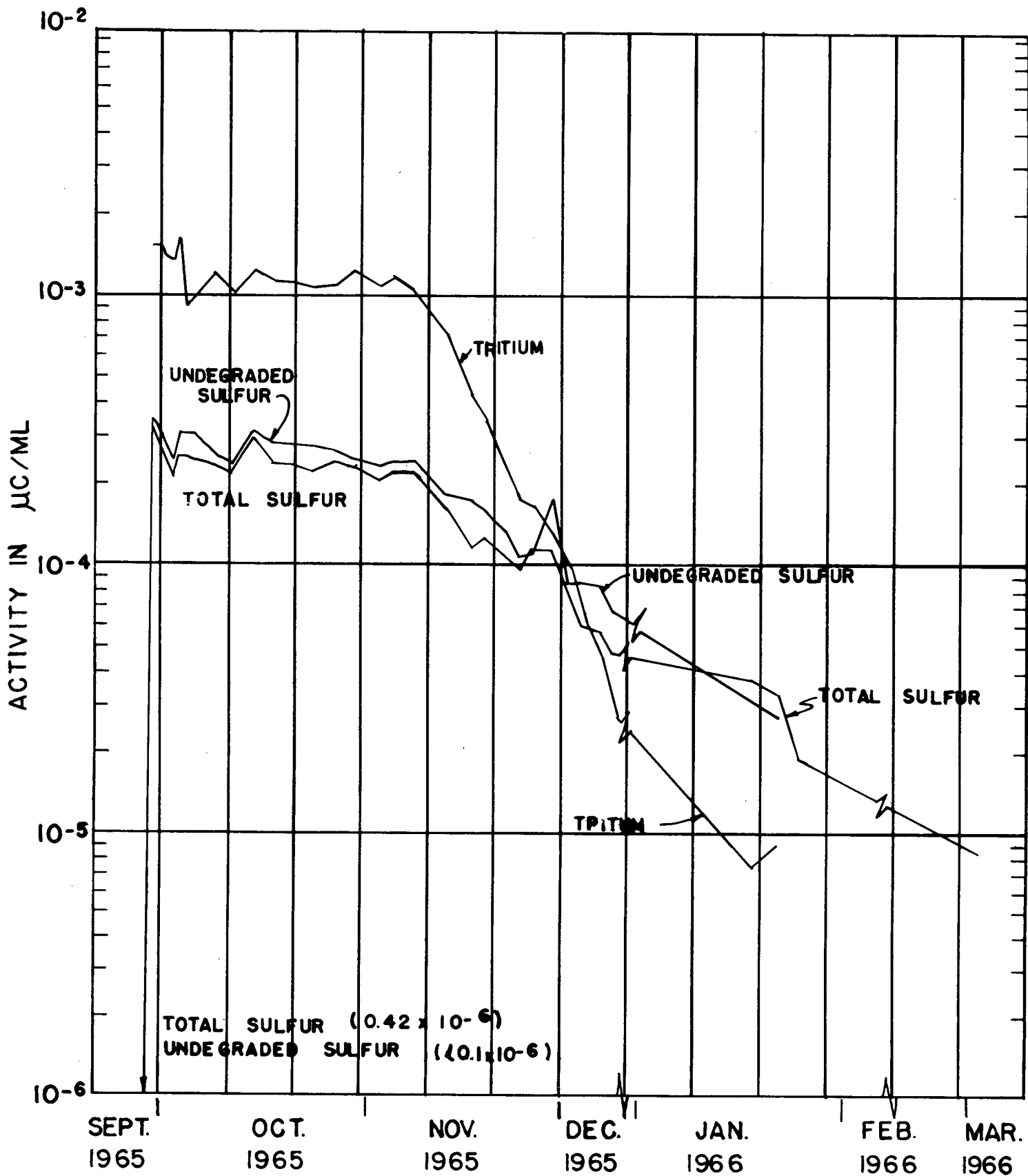

LONG ISLAND GROUND WATER POLLUTION STUDY
NEW TOP GRAVITY LONG SAMPLES
RADIOACTIVE TAGGING
SITE 3 PHASE II

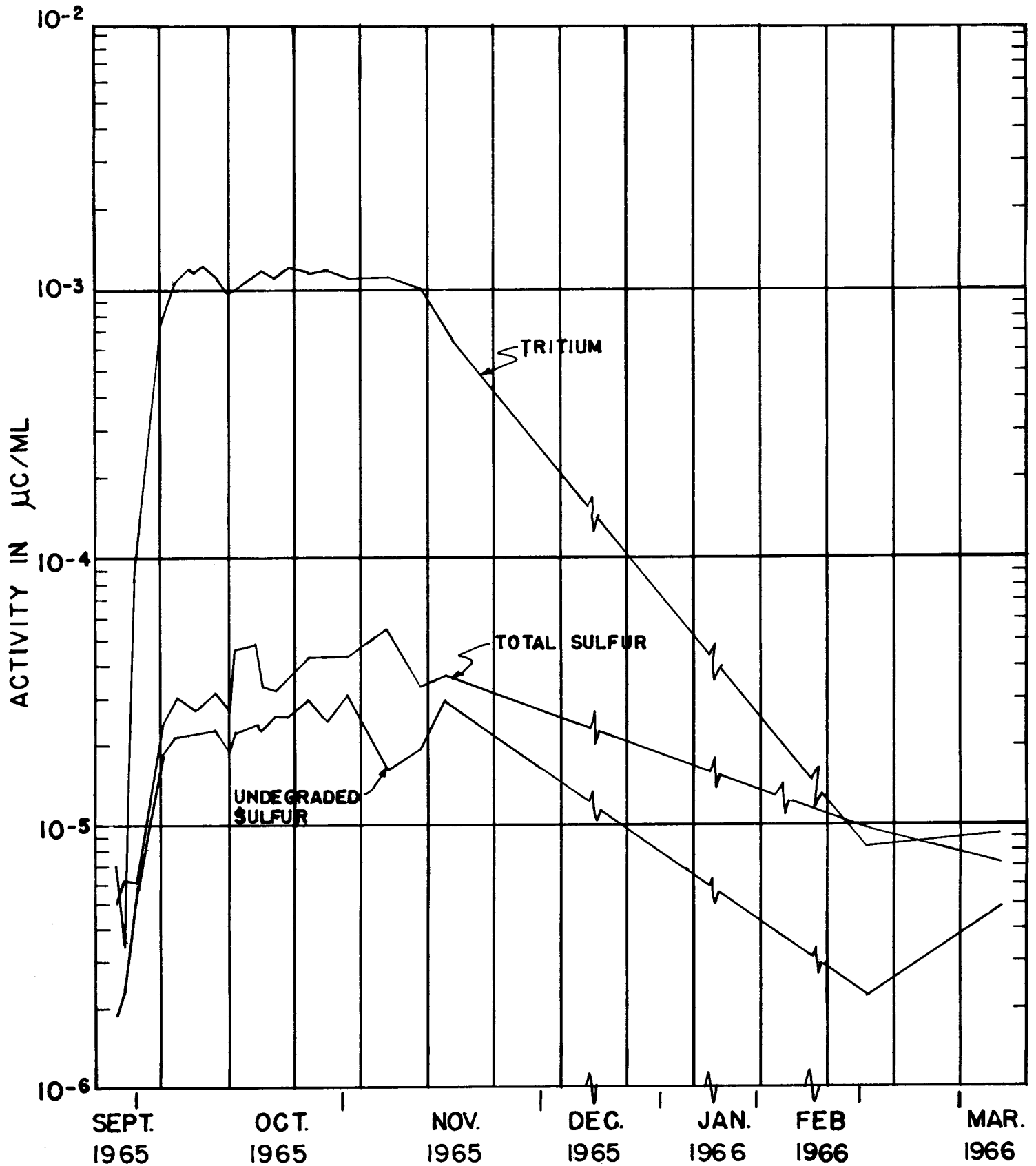

LONG ISLAND GROUND WATER POLLUTION STUDY
MIDDLE GRAVITY LONG SAMPLE
RADIOACTIVE TAGGING
SITE 3 PHASE II

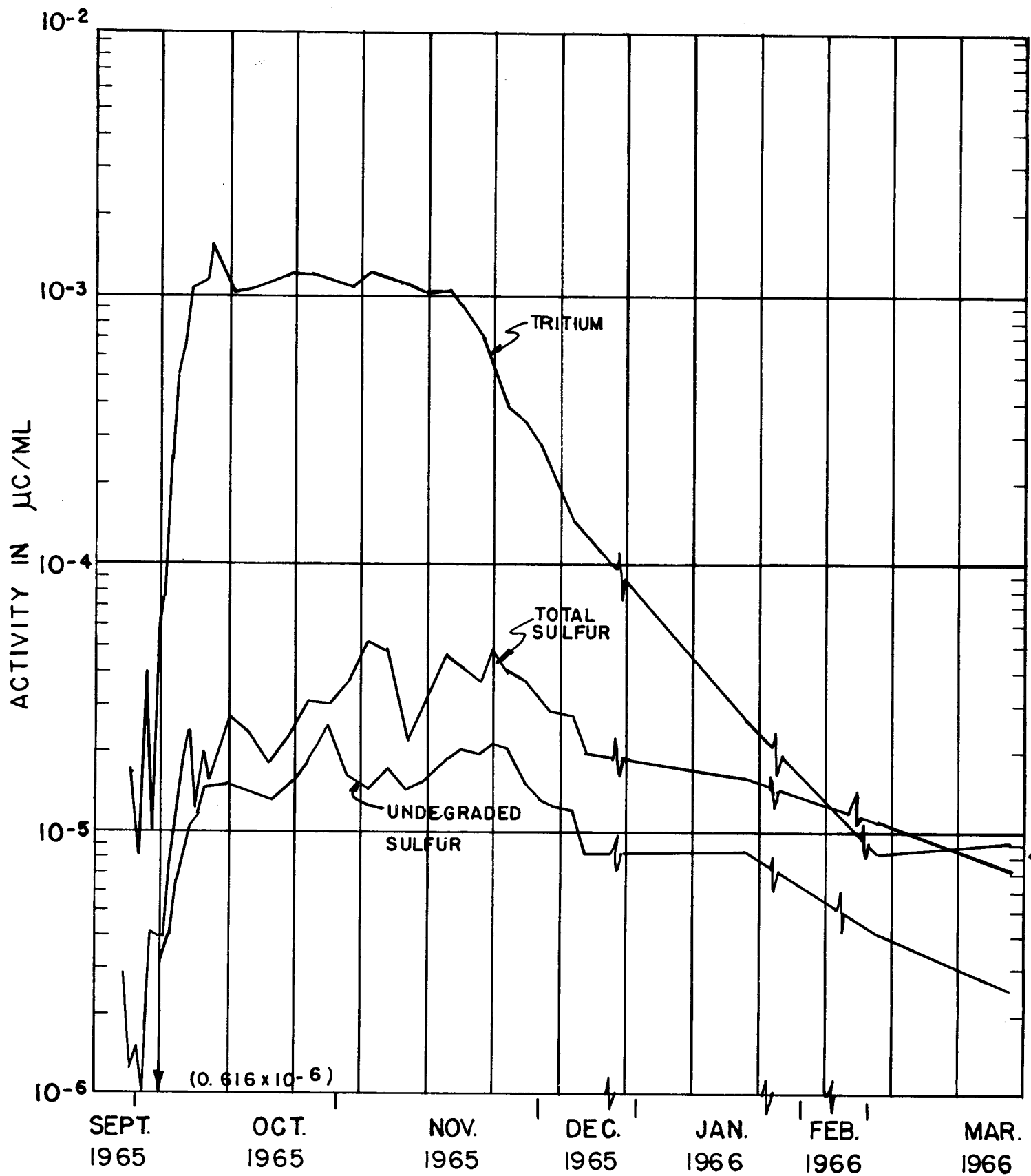

LONG ISLAND GROUND WATER POLLUTION STUDY

WELL No. 6

RADIOACTIVE TAGGING

SITE 3

PHASE II

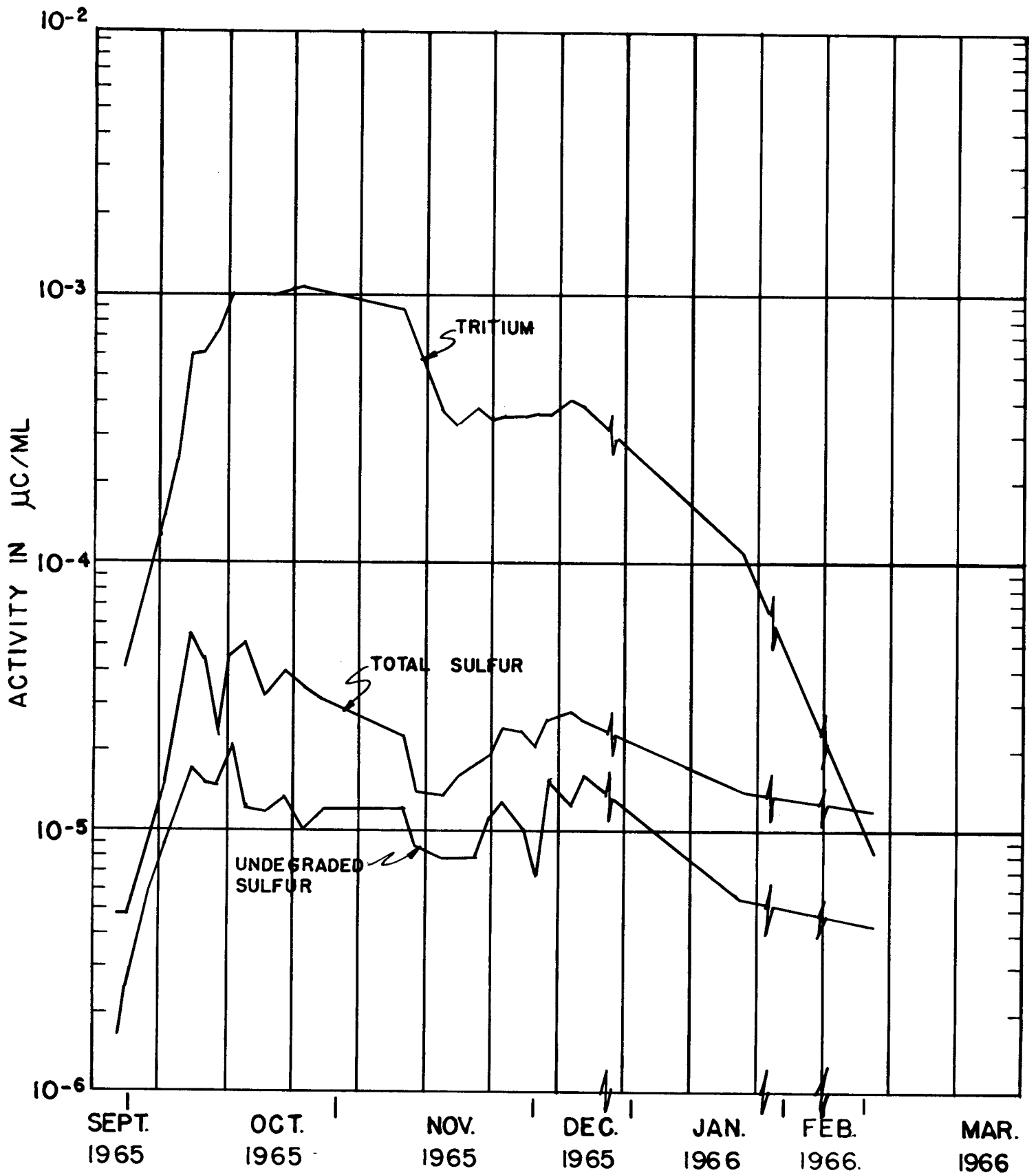

LONG ISLAND GROUND WATER POLLUTION STUDY
 WELLS No. 10 & 11
 RADIOACTIVE TAGGING
 SITE 3 PHASE II

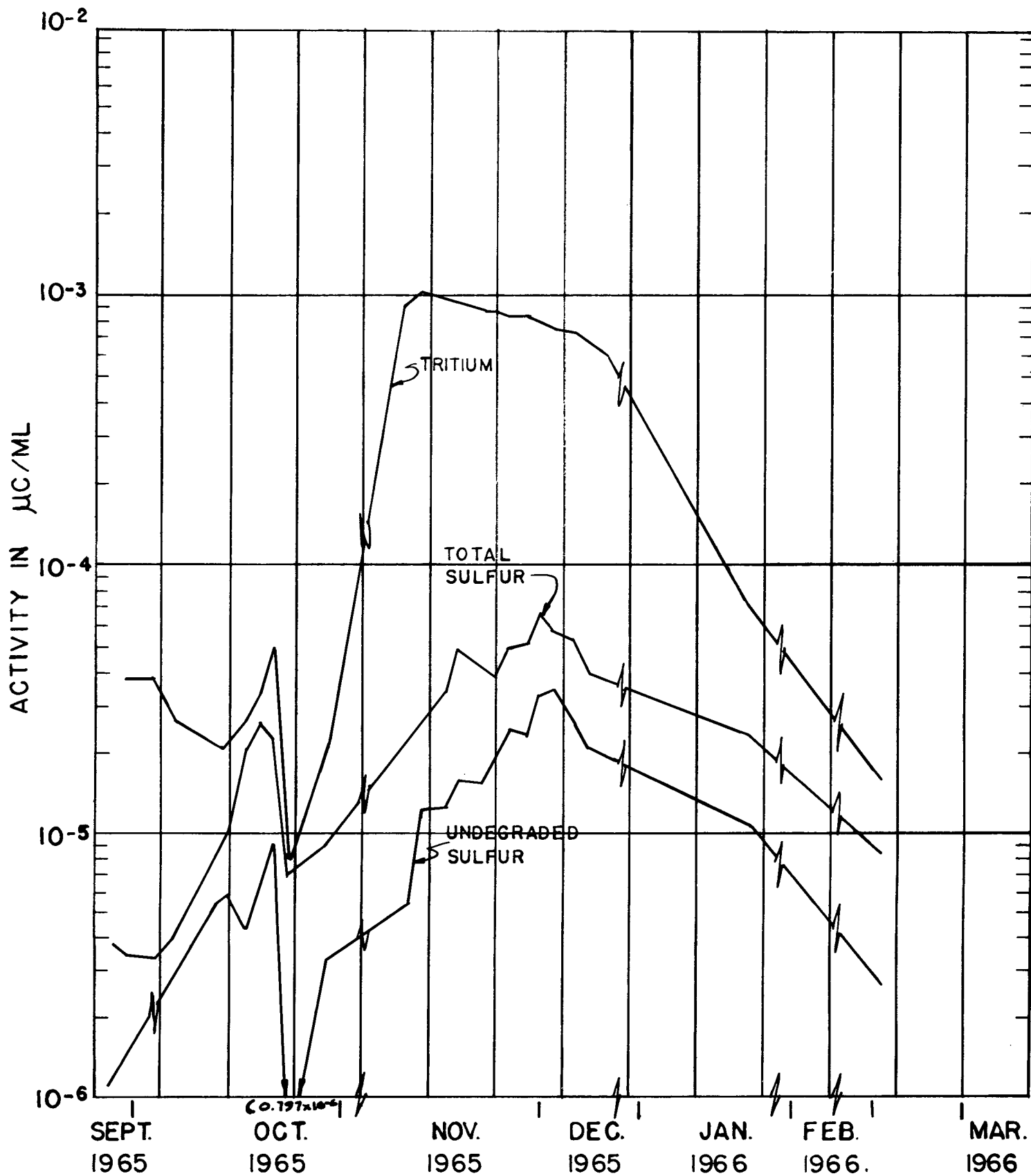

LONG ISLAND GROUND WATER POLLUTION STUDY
 WELLS No. 13 & 14
 RADIOACTIVE TAGGING
 SITE 3 PHASE II

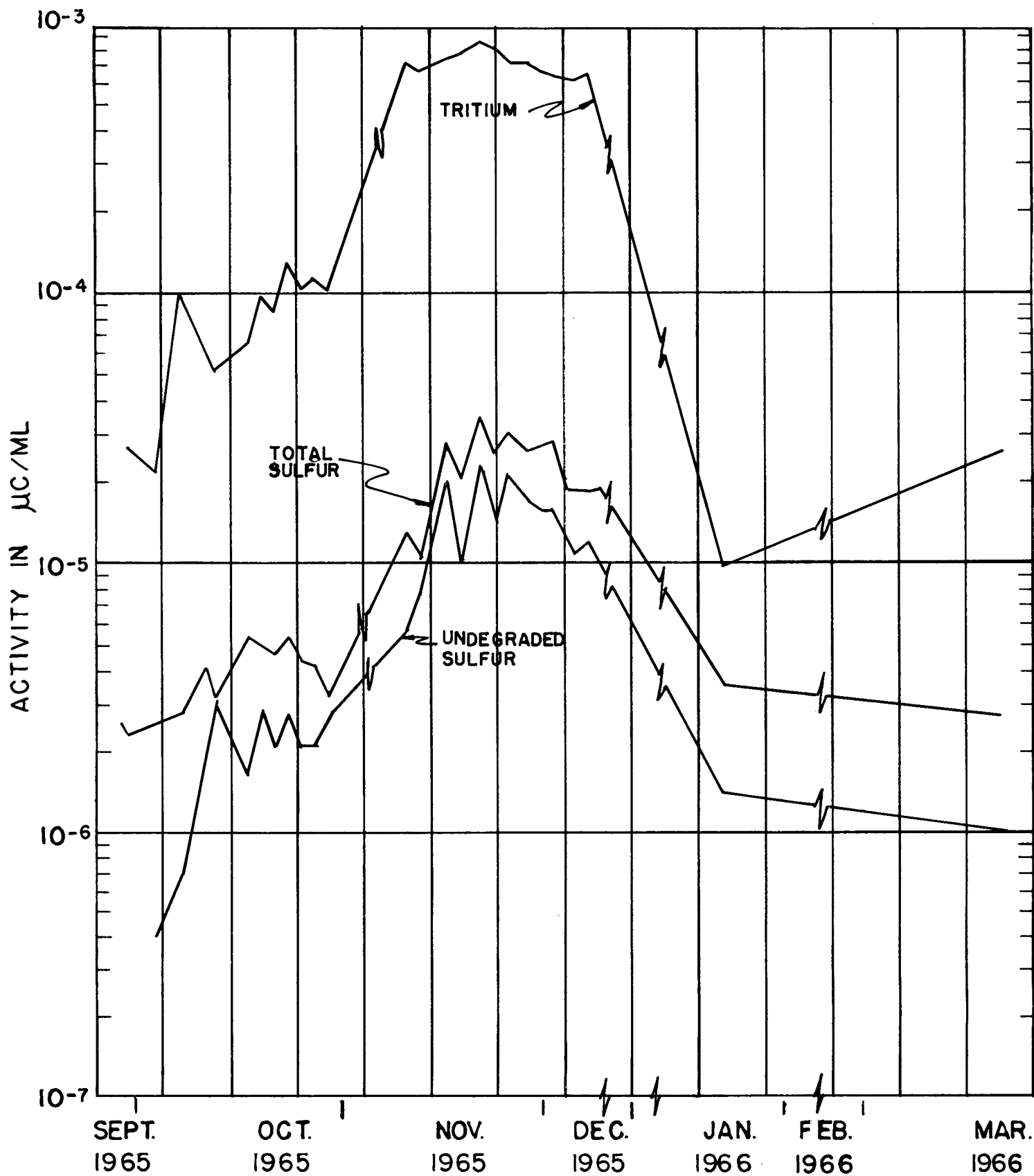

LONG ISLAND GROUND WATER POLLUTION STUDY
 RADIOACTIVE TAGGING - PHASE II
 TEST SHAFT RESULTS (9/28/1965-1/24/1966)
 SITE N° 3 - BOHEMIA, SUFFOLK COUNTY, N. Y.

10-37

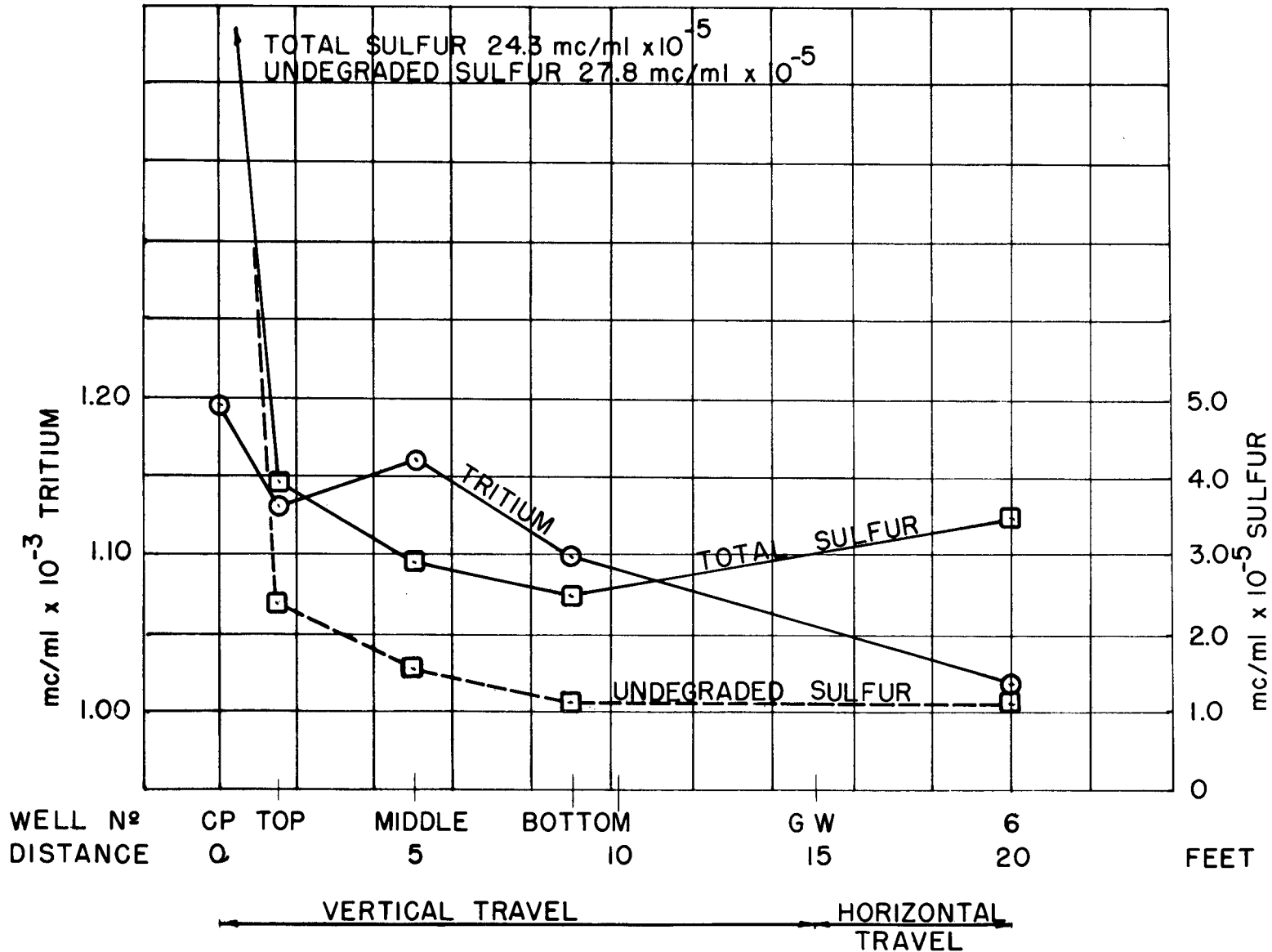

FIG. 10-16

LONG ISLAND GROUND WATER POLLUTION STUDY
 RADIOACTIVE TAGGING - PHASE II
 DOWNSTREAM WELLS (9/28/1965-1/24/1966)
 SITE N° 3 - BOHEMIA, SUFFOLK COUNTY, N. Y.

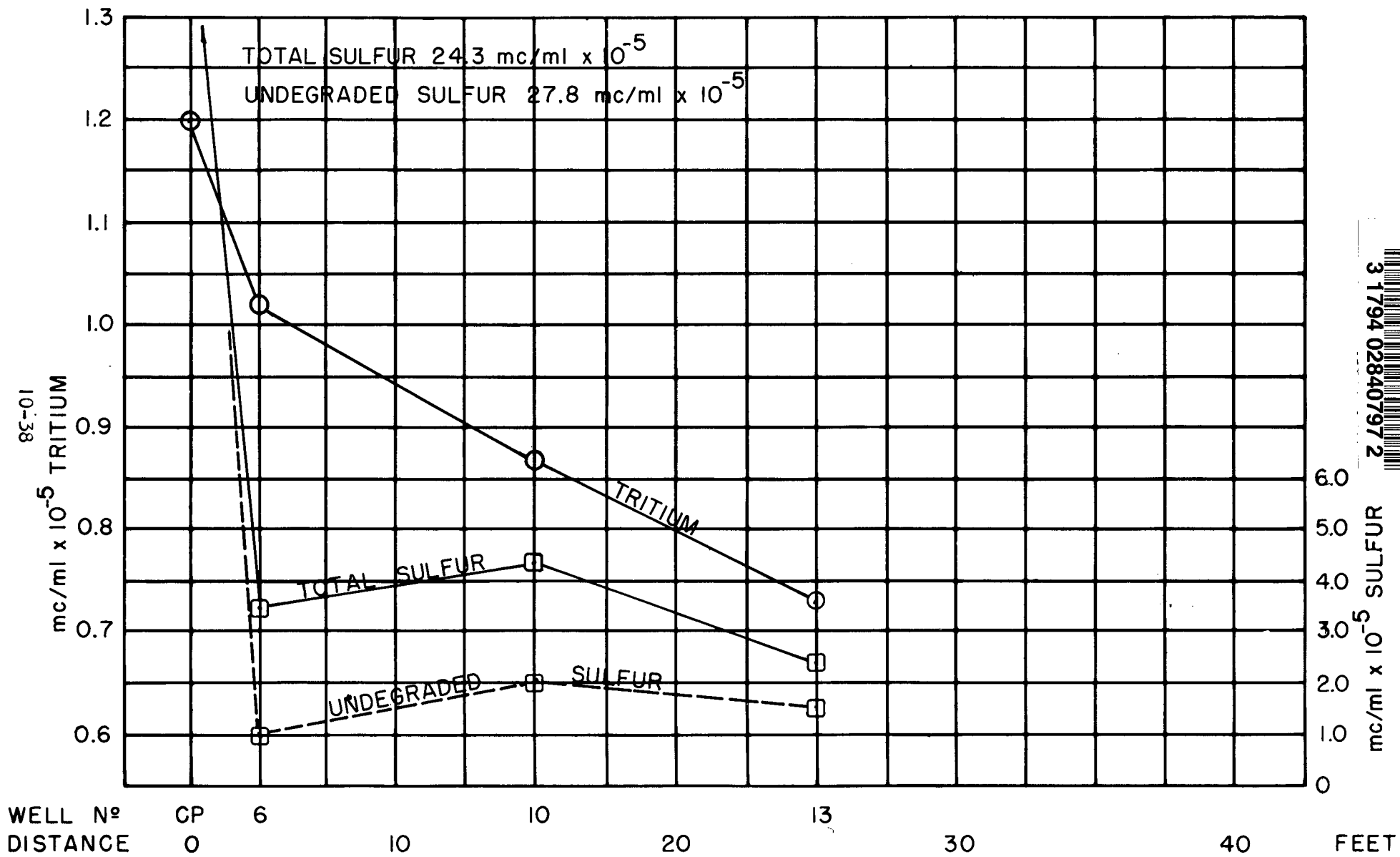

FIG. 10-17



New York State Department of Environmental Conservation

SAN-P3 (11/72)